

routes

reference guide

01.27.2025



teknion

update summary

Please be advised that information has been updated within the Routes Reference Guide. To highlight these updates, a summary has been created for your reference.

revised

General maintenance to this guide has been implemented.

Please note, first orders for new products will be accepted on January 27, 2025. All software will also be updated by January 27, 2025. If you have any questions regarding the information enclosed, please contact your Teknion Customer Service Representative.

table of contents

- WHAT IS ROUTES 4
- PRODUCT MAP 5
- FINISHES 12
- TABLES 16
- SCREENS 29
- STORAGE 38
- WORK & TECH BOARDS 45
- ELECTRICS & WIRE MANAGEMENT 52
- MULTI-USE SEATING 59
- SOFT SEATING 70

what is routes

intuitive, comfort, performance

Designed in partnership with PearsonLloyd, Routes is a collection of work tools driven by the concept, "What do we need, really need, to work efficiently and well?"

The Routes collection is designed to complement a strong story of agility, mobility and choice. The collection is made up of furniture, lighting and accessories, given fresh yet familiar forms that are easy to understand and to specify; easy to assemble, configure and use.

"Simplicity is inherent in the product. You know intuitively how to use it." Luke Pearson

"You don't need an instruction manual. Just grab what you need and enjoy using it." Tom Lloyd



routes product map

Routes provides a balanced portfolio of high-performance work tools: tables, seating, storage and screens, as well as accessories, lighting and a coordinated selection of textiles.

- The Coat Stand, Rocking Chair and Table Lamp offer a familiar residential look and feel
- A quirky Three Leg Stool takes inspiration from a ready-made utility object—a tractor seat—and offers the user ease of stepping on or off the stool
- A Mobile Soft Screen, Multi-Use Stool and Adjustable Side Table fulfill the intention to provide furniture that's as agile and as robust as possible

TABLES



Single Desk
(CQTDK)



Double Desk
(CQTDD)



Counter Height



Bar Height

Rectangular High Table
(CQTHR)



Counter Height



Bar Height

Racetrack High Table
(CQTHZ)



Task Height



Counter Height



Bar Height

Partner Table
(CQTHU)



Task Height



Counter Height



Bar Height

Rectangular Agile Table
(CQTAR)



Task Height



Counter Height



Bar Height

Racetrack Agile Table
(CQTAZ)



SoloMini Table
(CQTWT)



Rectangular Meeting
Table (CQTMR)



Square Meeting Table
(CQTMS)



Circular Meeting Table
(CQTMC)



Laptop Table
(CQTLT)



Rectangular Coffee
Table (CQTCR)



Oval Coffee Table
(CQTCV)



Circular Coffee Table
(CQTCC)



Circular Side Table
(CQTSC)



Square Side Table
(CQTSS)



Adjustable Side Table
(CQTSA)



Square Adjustable
Side Table (CQTSB)

routes product map

SCREENS



Gathered Fabric Mobile Screen (CQCFS)



Knit Mesh Table Screen (CQCTT)



Infinity Desk Edge Screen (CQCND)

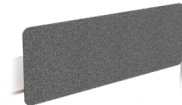

Smooth Felt Desk Edge Screen (CQCFD)



Smooth Felt Double Desk Screen (CQCDD)

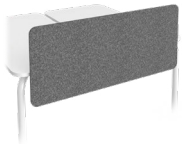

Smooth Felt Double Desk End Screen (CQCDE)

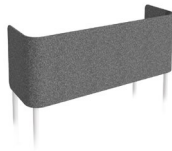

Smooth Felt Study Carrel (CQCSC)

STORAGE & WORK TOOLS



Personal Tote (CQCPT)



Utility Cart (CQCMT)



Shared Tote (CQCST)



Coat Stand (CQCCS)



Work Board (CQCWB)



Tech Board (CQCTB)



Add-On Boards (CQCAB)



Media Rover (CQCMS)

ELECTRICS & WIRE MANAGEMENT



Power Port (CQAMP)



Shared Power Hub (CQAPH)



Cable Manager (CQAWM)



Table Lamp (CQATL)

routes product map

MULTI-USE SEATING



Multi-Use Stool
(CQSM)



Multi-Use Stool
with Cushion
(CQSMU)



Halo Cushion
(CQSCP)



No Back With Back
Workshop Chair
(CQSCT)



No Back With Back
Workshop Stool
(CQSCH)



Tube Chair
(CQSTC)



Counter Height Bar Height
Tube Stool
(CQSTF)



Counter Height Bar Height
Three-Leg Stool
(CQSTS)

SOFT SEATING



Arc Chair
(CQSAC)



Rocking Chair
(CQSRC)



Meet n Greet Chair
(CQSMG)



1-Seater



2-Seater

Lounge Chair
(CQSLC)



1-Seater



1.5-Seater



2-Seater



3-Seater with 2 Cushions



3-Seater with 3 Cushions

Sofa, Low Back
(CQSSL)



1.5-Seater



2-Seater



3-Seater with 2 Cushions



3-Seater with 3 Cushions

Sofa, High Back
(CQSSLH)



Square



Rectangle

Cushion
(CQSCU)

light, agile, mobile

Routes encourages people to move about and to move their furniture around, to make or unmake a space in which to think, meet or create.



bold, playful, practical

Infused with a simple, direct functionality, Routes adds an expressive element through vivid accent colors Blue Sage and Signal Red.

Equally, the seamless bold curves of tubular steel are among the expressive shapes that give character to the collection. Routes offers a radically new profile and materiality for furniture for work environments.



routes sample layouts

Routes departs from conventional contract furniture with a toolbox of boldly conceived products that are simple and able.

The collection allows one to build-up a complete workspace for a small, tight-knit studio or create casual “pop-up” work hubs across the expanse of a corporate headquarters.

Routes readily adapts to spaces big and small, to the requirements of an established enterprise and to the needs of those who work at home.

“Routes is quite lighthearted, quite enjoyable to use as a collection.” Tom Lloyd

“Visually, Routes is bold enough so that as you pepper a landscape with various pieces, you recognize that it’s a bit different.” Luke Pearson

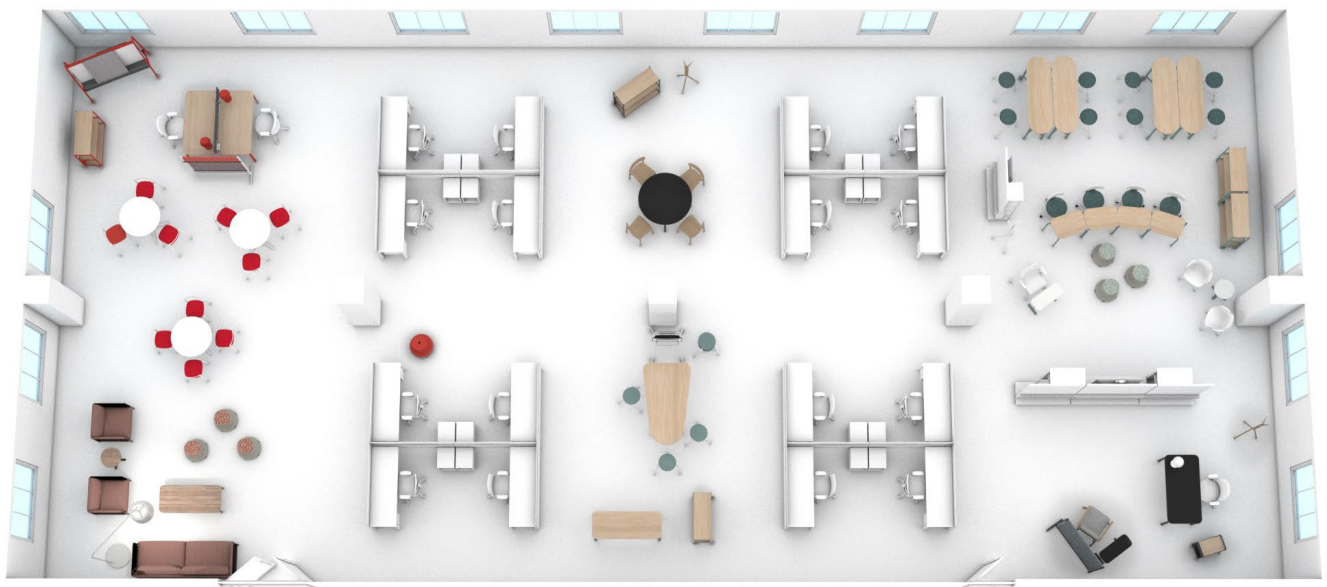
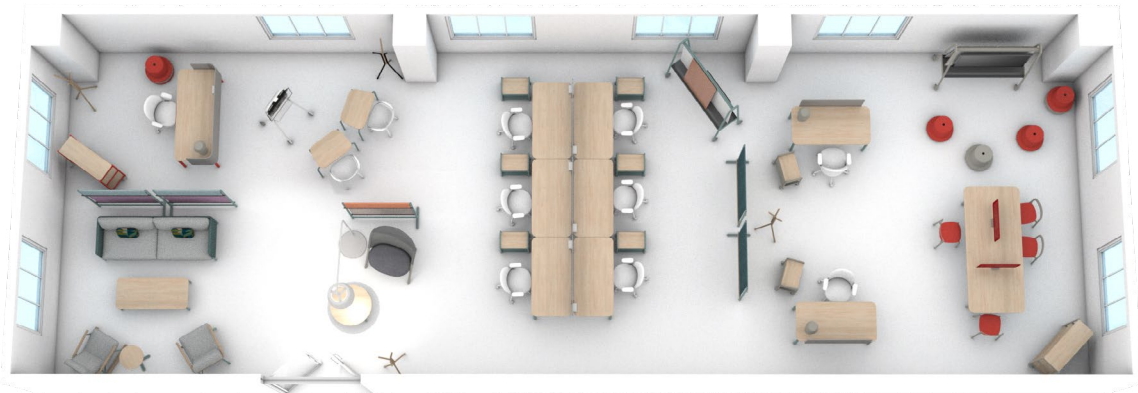

routes sample layouts

The Teknion Planning Tool provides idea starters for planning with Routes products. Assets are also available for presentations and specifying Teknion products. The following are a few examples.

TEKNION PLANNING TOOL – ROUTES



routes finishes

FOUNDATION LAMINATES

All Teknion Foundation Laminates.

 [SAMPLE CARD](#)

GRADE 2 LAMINATES

All Teknion Grade 2 Laminate.

 [SAMPLE CARD](#)

SMOOTH FELT (SCREENS)

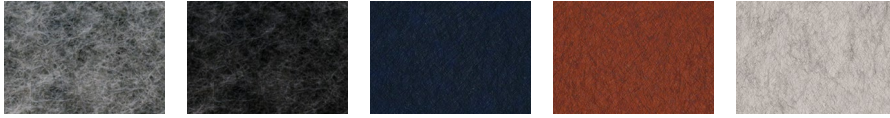

Pewter
(R5)

Lunar
(R6)

Admiral Blue
(QR)

Sumac
(QS)

River Rock
(QT)

KNIT LINX (SCREENS)

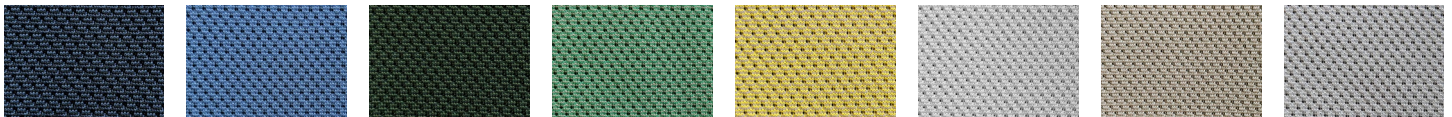

Midnight
(K450)

Brook
(K446)

Evergreen
(K449)

Sage
(K445)

Citrine
(K444)

Pewter
(K441)

Shale
(K443)

Cool Grey
(K440)

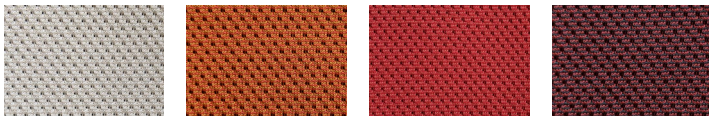

Warm Grey
(K442)

Apricot
(K448)

Poppy
(K447)

Pomegranate
(K451)

FOUNDATION PAINT

All Teknion Foundation, Mica and Accent paints.
Applicable to Sicla Bases.

 [FOUNDATION SAMPLE CARD](#)

MICA PAINT

All Teknion Foundation, Mica and Accent paints.
Applicable to Sicla Bases.

 [MICA SAMPLE CARD](#)

ACCENT PAINT

All Teknion Foundation, Mica and Accent paints.
Applicable to Sicla Bases.

 [ACCENT SAMPLE CARD](#)

routes finishes

METAL FRAME (SEATING)



Clay
(85)



Blue Sage
(98)



Signal Red
(97)

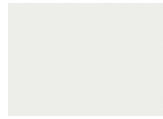

Atrium White
(20)



Anthracite
(68)

WOOD STAINS (SCREENS/SEATING)



Sisal
(VM)

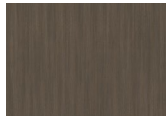

Greystone
(BR)

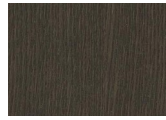

Truffle
(DZ)

PLASTIC (SEATING)



Clay
(NH)



Blue Sage
(7X)



Signal Red
(7W)

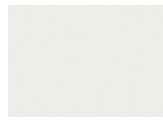

Atrium White
(8D)



Blackstone
(NF)

MESH (SEATING)



Midnight
(AR01)



Peppercorn
(AR02)





routes tables overview

- Routes Desks and Meeting Tables have a tubular leg aesthetic
- The collection is ideal for individual or shared work settings as well as meeting rooms
- All Routes tables include hook and loop cable management straps for routing cables. See the *Electric* section of this Guide for details
- Routes Single and Double Desks are compatible with both Swerv and Mast monitor arms

FRAMES

Routes Desk and Table frames are available in three profiles: Agile, Fixed and Mobile.

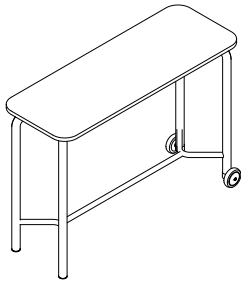

Agile tables have in-line wheels on one end and glides on the opposite end.

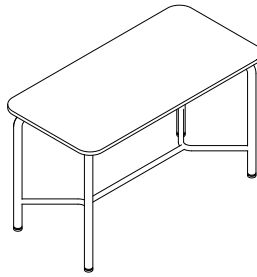

Fixed tables have four levelers.

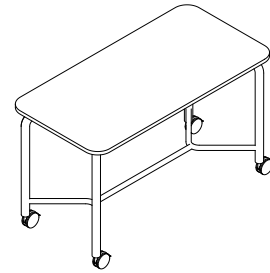

Mobile tables have four casters.

EDGE TRIM

All Routes Tables have a Foundation Laminate top and a flat edge trim that can be specified to match or contrast with the top.

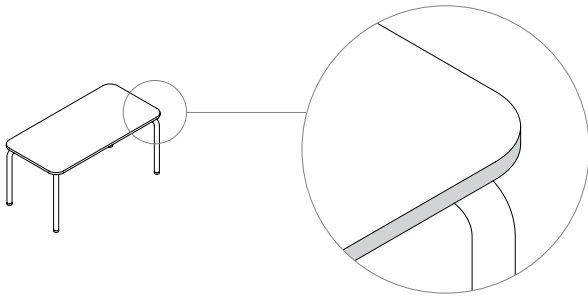

DATUM HEIGHTS

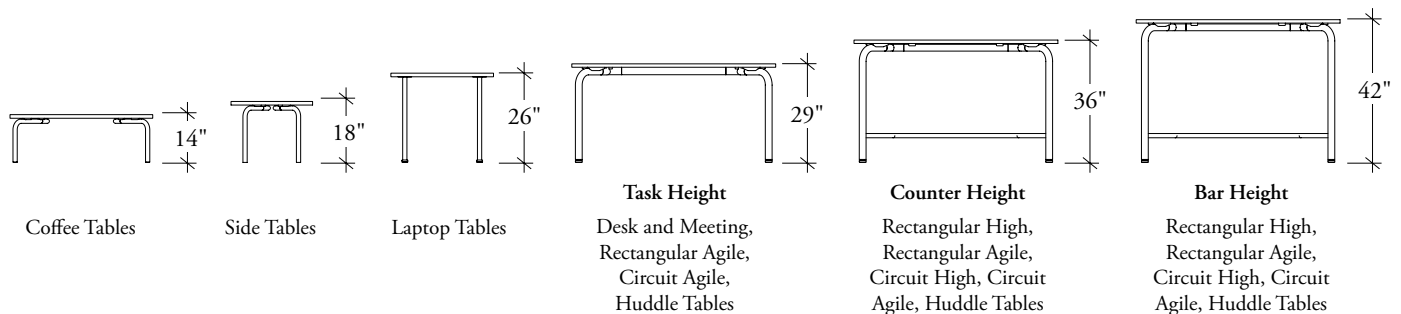

routes tables overview

DIMENSIONS

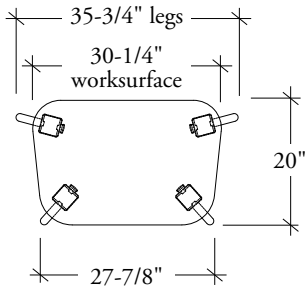

SoloMini Table

- Parallel sides are not the same dimensions, providing additional planning flexibility
- The table legs extend beyond the sides of the worksurface, giving more leg room

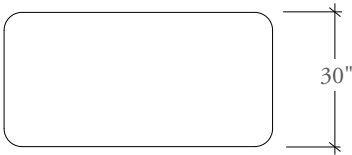

High Table

- 30" deep
- Option of either four levelers or four casters

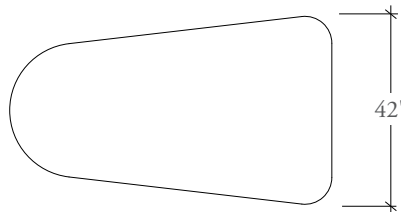

Partner Table

- 42" deep
- Option of either four levelers or four casters

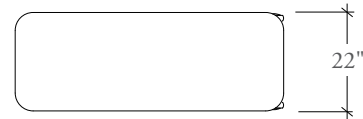

Agile Table

- 22" deep
- Always with two wheels and two glides

FOOT RAIL

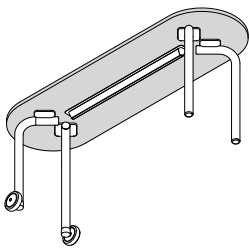

29" high tables do not have a foot rail.

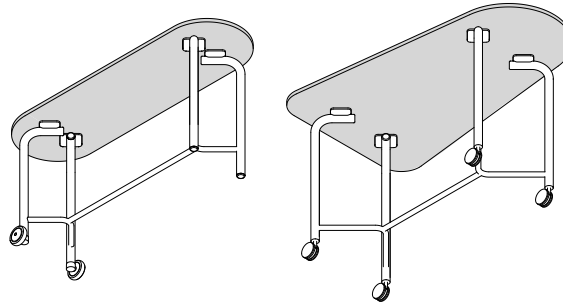

36" and 42" high tables have a foot rail.

HEIGHT-ADJUSTABLE TABLE

hiSpace offers a round leg base, and worksurface sizes and finishes to match the Routes aesthetic.
Available from Complements: *Teknion's Ergonomics & Accessories Program.*

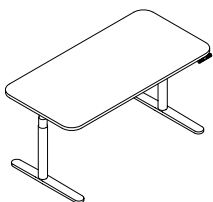

planning with routes tables

SOLOMINI TABLES

SoloMini Tables can be used for solo focus work or grouped together for collaborative applications and can also be stacked to a maximum of four high for storage.

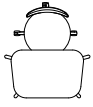

Individual Work

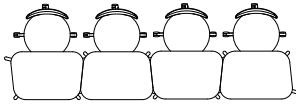

In-Line or Against a Wall

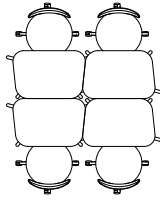

Group Work Together

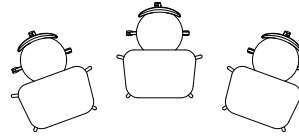

Group Work Apart / Presentation / Conferencing

AGILE TABLES

Agile Tables can be planned oriented towards a fixed point of attention such as a speaker or a screen.

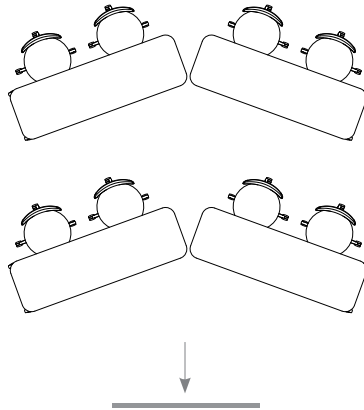
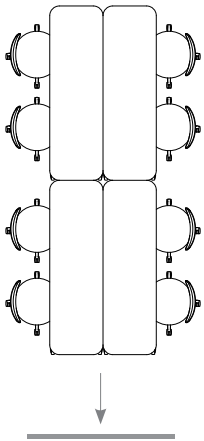

They can also be re-oriented to face each other when pivoting towards a more interactive/collaborative setting.

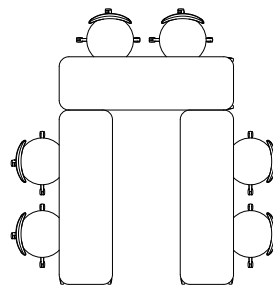
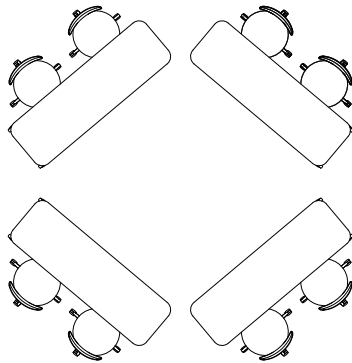
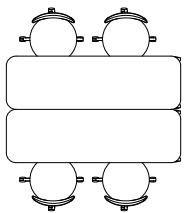

routes tables

single desk (CQTDK)



Fixed



Mobile

PRODUCT OPTIONS

Configuration	Depth	Width	Cable Manager	Frame Finish	Surface Finish	Edge Trim Style	Edge Trim Finish
M Mobile F Fix	30	60, 72	N None Y Yes	Foundation Mica Accent	Foundation Laminate Grade 2 Laminate	8 Flat Trim	Edge Trim Colors

PRICING

Code	Product Name	Dimensions	Foundation Laminate	Grade 2 Laminate
CQTDK	Single Desk Fixed	30"d x 60"w	929	1085
		30"d x 72"w	944	1100
	Single Desk Mobile	30"d x 60"w	959	1115
		30"d x 72"w	975	1130

routes tables

double desk [CQTDD]



PRODUCT OPTIONS

Depth	Width	Cable Manager	Frame Finish	Surface Finish	Edge Trim Style	Edge Trim Finish
60	60	N None S Single D Double	Foundation Mica Accent	Foundation Laminate Grade 2 Laminate	8 Flat Trim	Edge Trim Colors

PRICING

Code	Product Name	Dimensions	Foundation Laminate	Grade 2 Laminate
CQTDD	Double Desk	60"d x 60"w	1643	1954

If Single Cable Manager is specified, add 128

If Double Cable Manager is specified, add 256

routes tables

rectangular high table (CQTHR)



Counter Height Fixed



Counter Height Mobile



Bar Height Fixed



Bar Height Mobile

PRODUCT OPTIONS

Height	Mobility	Depth	Width	Frame Finish	Surface Finish	Edge Trim Style	Edge Trim Finish
C Counter B Bar	F Fixed M Mobile	30	60, 72	Foundation Mica Accent	Foundation Laminate Grade 2 Laminate	8 Flat Trim	Edge Trim Colors

PRICING

Code	Product Name	Dimensions	Foundation Laminate	Grade 2 Laminate
CQTHR	Rectangular High Table Fixed (C)	30" d x 60" w	1264	1420
		30" d x 72" w	1326	1482
	Rectangular High Table Fixed (B)	30" d x 60" w	1264	1450
		30" d x 72" w	1326	1512
	Rectangular High Table Mobile (C)	30" d x 60" w	1295	1420
		30" d x 72" w	1356	1482
	Rectangular High Table Mobile (B)	30" d x 60" w	1295	1450
		30" d x 72" w	1356	1512

routes tables

racetrack high table (CQTHZ)



Counter Height Fixed



Counter Height Mobile



Bar Height Fixed



Bar Height Mobile

PRODUCT OPTIONS

Height	Mobility	Depth	Width	Frame Finish	Surface Finish	Edge Trim Style	Edge Trim Finish
C Counter B Bar	F Fixed M Mobile	30	72	Foundation Mica Accent	Foundation Laminate Grade 2 Laminate	8 Flat Trim	Edge Trim Colors

PRICING

Code	Product Name	Dimensions	Foundation Laminate	Grade 2 Laminate
CQTHZ	Racetrack High Table Fixed (C)	30" d x 72" w	1326	1482
	Racetrack High Table Fixed (B)	30" d x 72" w	1326	1482
	Racetrack High Table Mobile (C)	30" d x 72" w	1356	1512
	Racetrack High Table Mobile (B)	30" d x 72" w	1356	1512

routes tables

partner table (CQTHU)

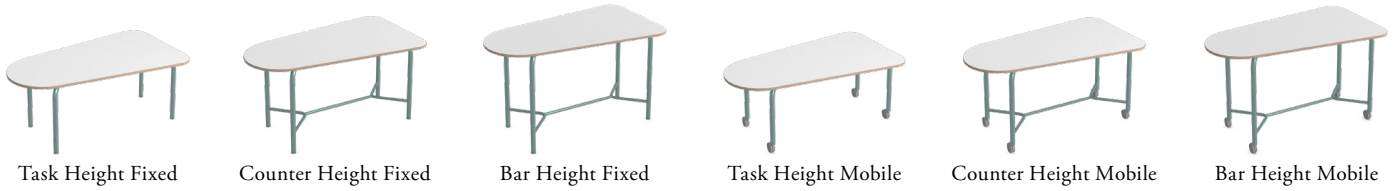

PRODUCT OPTIONS

Height	Mobility	Depth	Width	Frame Finish	Surface Finish	Edge Trim Style	Edge Trim Finish
T Task C Counter B Bar	F Fixed M Mobile	42	72	Foundation Mica Accent	Foundation Laminate Grade 2 Laminate	8 Flat Trim	Edge Trim Colors

PRICING

Code	Product Name	Dimensions	Foundation Laminate	Grade 2 Laminate
CQTHU	Partner Table Fixed (T)	42" d x 72" w	1138	1449
	Partner Table Fixed (C)	42" d x 72" w	1326	1637
	Partner Table Fixed (B)	42" d x 72" w	1326	1637
	Partner Table Mobile (T)	42" d x 72" w	1168	1480
	Partner Table Mobile (C)	42" d x 72" w	1356	1668
	Partner Table Mobile (B)	42" d x 72" w	1356	1668

routes tables

rectangular agile table (CQTAR)



Task Height



Counter Height



Bar Height

PRODUCT OPTIONS

Height	Depth	Width	Frame Finish	Surface Finish	Edge Trim Style	Edge Trim Finish
T Task C Counter B Bar	22	60, 72	Foundation Mica Accent	Foundation Laminate Grade 2 Laminate	8 Flat Trim	Edge Trim Colors

PRICING

Code	Product Name	Dimensions	Foundation Laminate	Grade 2 Laminate
CQTAR	Rectangular Agile Table (T)	22" d x 60" w	937	1062
		22" d x 72" w	964	1120
	Rectangular Agile Table (C)	22" d x 60" w	1058	1182
		22" d x 72" w	1124	1280
	Rectangular Agile Table (B)	22" d x 60" w	1058	1182
		22" d x 72" w	1124	1280

routes tables

racetrack agile table (CQTAZ)



Task Height



Counter Height



Bar Height

PRODUCT OPTIONS

Height	Depth	Width	Frame Finish	Surface Finish	Edge Trim Style	Edge Trim Finish
T Task C Counter B Bar	22	72	Foundation Mica Accent	Foundation Laminate Grade 2 Laminate	8 Flat Trim	Edge Trim Colors

PRICING

Code	Product Name	Dimensions	Foundation Laminate	Grade 2 Laminate
CQTAZ	Racetrack Agile Table (T)	22"d x 72"w	964	1120
	Racetrack Agile Table (C)	22"d x 72"w	1124	1280
	Racetrack Agile Table (B)	22"d x 72"w	1124	1280

routes tables

solomini table
(CQTWT)



rectangular meeting table
(CQTMR)



square meeting table
(CQTMS)



circular meeting table
(CQTMC)



rectangular coffee table
(CQTCR)



oval coffee table
(CQTCU)



circular coffee table
(CQTCG)



circular side table
(CQTSC)



square side table
(CQTSS)



adjustable side table
(CQTSA)



square adjustable side table
(CQTSA)



laptop table
(CQTLT)



Pricing is on the following page.

routes tables

tables (continued)

PRODUCT OPTIONS

Depth	Width	Frame Finish	Surface Finish	Edge Trim Style	Edge Trim Finish
refer to pricing chart	refer to pricing chart	Foundation Mica Accent	Foundation Laminate Grade 2 Laminate	8 Flat Trim	Edge Trim Colors

PRICING

Code	Product Name	Dimensions	Foundation Laminate	Grade 2 Laminate
CQTWT	SoloMini Table	20" d x 30" w	536	613
CQTMR	Rectangular Meeting Table	36" d x 84" w	1569	1900
		42" d x 96" w	1627	1959
CQTMS	Square Meeting Table	42" d x 42" w	1021	1187
CQTMC	Circular Meeting Table	48" diameter	1022	1188
CQTCR	Rectangular Coffee Table	24" d x 42" w	771	875
		24" d x 54" w	791	915
CQTCV	Oval Coffee Table	24" d x 54" w	791	915
CQTCC	Circular Coffee Table	32" diameter	744	821
CQTSC	Circular Side Table	24" diameter	611	666
CQTSS	Square Side Table	24" d x 24" w	611	666
CQTSA	Adjustable Side Table	18" diameter	565	587
CQTSB	Square Adjustable Side Table	16" d x 16" w	565	587
CQTLT	Laptop Table	12" d x 30" w	304	331



routes soft & knit screens overview

MOBILE SCREENS

The Gathered Fabric Mobile Screen, with its oversized fabric width, creates a dynamic gathering effect. It adds visual interest and texture, enhancing workspace appeal while maintaining functionality and providing stylish space division.

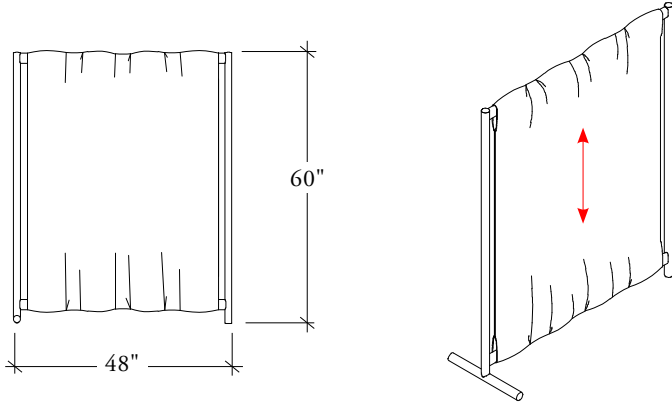

Fabric direction is off the bolt.
Selected upholstery fabrics are available from Grade 1 to 9.

KNIT MESH SCREENS

The Knit Mesh Table Screen is a freestanding screen that can be used throughout a space, either on the end of a desk or to provide space division on a table.

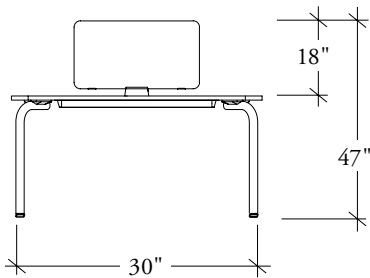

INFINITY DESK EDGE SCREENS

Modesty Height (15" from the floor)

Partial Modesty Height (23" from the floor)

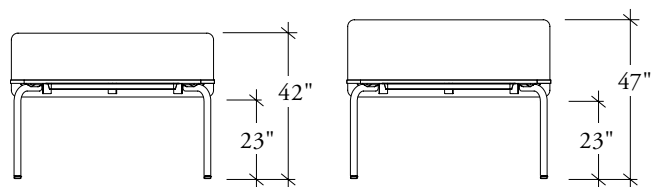
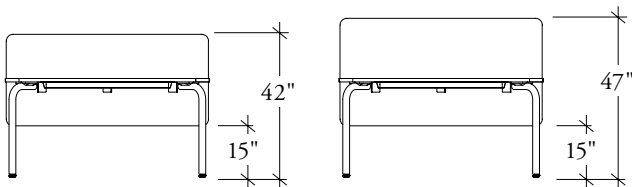

routes soft & knit screens

gathered fabric mobile screen [CQCFS]



PRODUCT FINISHES

Gathered Fabric Offering:

Actuate	Cult Classic	Graviton	Milieu
Adage	Digi Tweed	Grid State	Oeuvre
Ample	Doyenne	Heather Tech	Particulate
Barberpole Basket	Duo Chrome	High Frequency	Percept
Bitstream	Ecotone	Homage	Situ
Complect	Elastic Wool	Interstice	Stimuli
Complement	Ephemera	Intone	Texture Map
Construct	Flex Wool	Intraweb	Twisted Tweed
Contrast Slub	Fundamentals	Megacheck	Wavefield
Cross Dye	Graph Speck	Melange Check	Wool Fleck

PRODUCT OPTIONS

Height	Width	Screen Finish	Frame Finish
60 (datum height)	48	Upholstery Fabrics	Foundation Mica Accent

PRICING

Code	Dimensions	COM	Gr. 1	Gr. 2	Gr. 3	Gr. 4	Gr. 5	Gr. 6	Gr. 7	Gr. 8	Gr. 9
CQCFS	60"h x 48"w	647	647	710	761	826	883	966	1023	1101	1143

routes soft & knit screens

knit mesh table screen (CQCTT)



PRODUCT FINISHES

Knit Linx Finish:



PRODUCT OPTIONS

Height	Width	Screen Finish	Base Finish
47	30	Knit Linx	Foundation Mica Accent

PRICING

Code	Product Name	Dimensions	Price
CQCTT	Knit Mesh Table Screen	18" h x 30"w	326

routes soft & knit screens

infinity desk edge screen (CQCND)

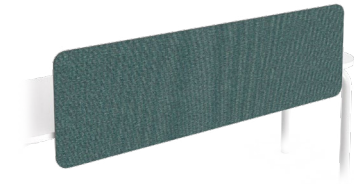

PRODUCT OPTIONS

Modesty Base Height	Height	Width	Screen Finish	Hardware Finish
S Partial Modesty (23") M Modesty (15")	42 42 Datum Height 47 47 Datum Height	48, 60, 72	Panel Fabrics Upholstery Fabrics	Foundation Mica Accent

PRICING

PARTIAL MODESTY HEIGHT (23" FROM THE FLOOR)																
Dimensions	Panel Fabric						Upholstery Fabric									
	COM/ Gr. A	Gr. 1	Gr. 2	Gr. 3	Gr. 4	Gr. 5	COM/ Gr. 1	Gr. 2	Gr. 3	Gr. 4	Gr. 5	Gr. 6	Gr. 7	Gr. 8	Gr. 9	Gr. 10
42"h x 48"w	461	468	479	510	531	553	464	489	500	518	542	556	571	600	628	641
42"h x 60"w	545	553	563	604	628	657	550	580	593	613	642	661	677	713	748	764
42"h x 72"w	589	600	611	655	687	717	592	630	645	668	701	721	740	782	824	843
47"h x 48"w	602	612	625	681	721	760	605	648	669	696	738	762	787	835	887	910
47"h x 60"w	717	731	751	819	868	911	722	776	800	834	886	914	944	1007	1069	1095
47"h x 72"w	797	812	833	911	966	1017	800	864	890	929	987	1022	1057	1129	1199	1229

MODESTY HEIGHT (15" FROM THE FLOOR)																
Dimensions	Panel Fabric						Upholstery Fabric									
	COM/ Gr. A	Gr. 1	Gr. 2	Gr. 3	Gr. 4	Gr. 5	COM/ Gr. 1	Gr. 2	Gr. 3	Gr. 4	Gr. 5	Gr. 6	Gr. 7	Gr. 8	Gr. 9	Gr. 10
42"h x 48"w	597	610	623	678	713	753	603	646	665	692	734	758	782	831	882	902
42"h x 60"w	708	722	740	806	847	899	713	767	791	823	874	902	932	993	1055	1083
42"h x 72"w	785	800	822	898	952	1007	791	853	881	918	978	1010	1044	1114	1188	1215
47"h x 48"w	694	707	724	789	836	876	698	748	771	804	852	881	910	966	1024	1049
47"h x 60"w	913	928	950	1028	1078	1136	918	981	1009	1047	1107	1142	1175	1249	1320	1350
47"h x 72"w	996	1015	1040	1130	1187	1256	1004	1075	1108	1152	1221	1259	1299	1384	1467	1501

routes screens overview

SMOOTH FELT DESK EDGE SCREEN

Attach to worksurfaces to create privacy and space division.

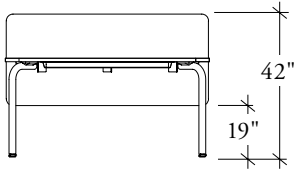

Semi Modesty Height (19" from the floor)

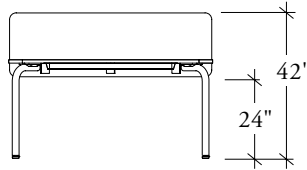

Slim Modesty Height (24" from the floor)

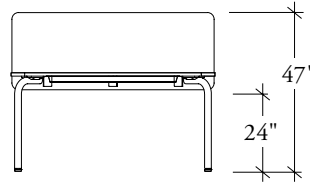

SMOOTH FELT DOUBLE DESK END SCREEN

Provides privacy on the end of a double desk. Available in 54" width.

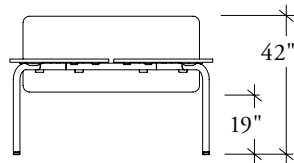

Semi Modesty Height (19" from the floor)

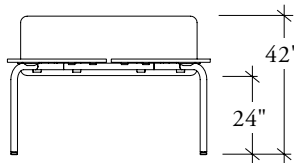

Slim Modesty Height (24" from the floor)

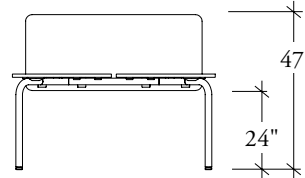

SMOOTH FELT DOUBLE DESK SCREEN

Provides privacy between two users of a double desk.

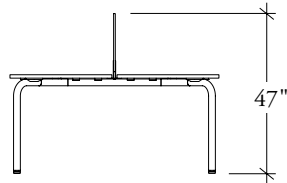
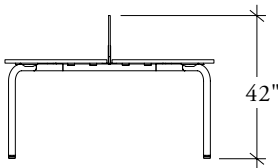

SMOOTH FELT CARREL SCREEN

Wraps around a desk to provide privacy on the three sides.

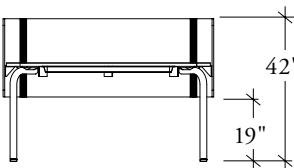

Semi Modesty Height (19" from the floor)

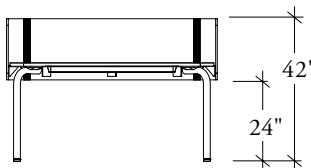

Slim Modesty Height (24" from the floor)

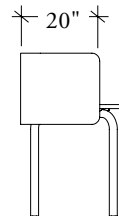
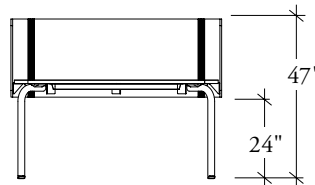

routes screens

smooth felt desk edge screen (CQCFD)

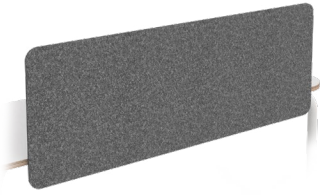

PRODUCT FINISHES

Smooth Felt Finish:

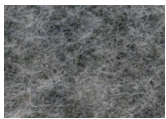

Pewter
(R5)



Lunar
(R6)



River Rock
(QT)

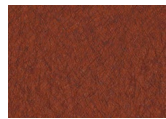

Sumac
(QS)

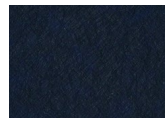

Admiral Blue
(QR)

PRODUCT OPTIONS

Height	Modesty Base Height	Width	Smooth Felt Finish	Hardware Finish
42 42 Datum Height 47 47 Datum Height	L Slim (24") T Semi (19")	48, 60, 72	Smooth Felt Finish	Foundation Mica

PRICING

Code	Product Name	Dimensions	Price
CQCFD	Smooth Felt Desk Edge Screen	42" h x 19" from floor x 48" w	276
		42" h x 19" from floor x 60" w	499
		42" h x 19" from floor x 72" w	506
		42" h x 24" from floor x 48" w	276
		42" h x 24" from floor x 60" w	499
		42" h x 24" from floor x 72" w	506
		47" h x 24" from floor x 48" w	276
		47" h x 24" from floor x 60" w	499
		47" h x 24" from floor x 72" w	506

routes screens

smooth felt double desk screen (CQCDD)

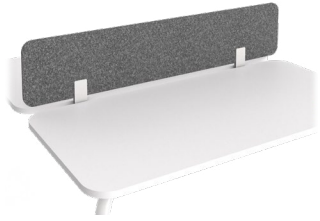

PRODUCT FINISHES

Smooth Felt Finish:

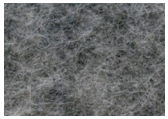

Pewter
(R5)



Lunar
(R6)



River Rock
(QT)

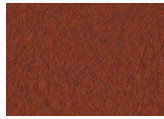

Sumac
(QS)



Admiral Blue
(QR)

PRODUCT OPTIONS

Height	Width	Smooth Felt Finish	Hardware Finish
42 42 Datum Height 47 47 Datum Height	48, 60	Smooth Felt Finish	Foundation Mica Accent

PRICING

Code	Product Name	Dimensions	Price
CQCDD	Smooth Felt Double Edge Screen	42"h x 48"w	233
		42"h x 60"w	370
		47"h x 48"w	298
		47"h x 60"w	520

routes screens

smooth felt double desk end screen (CQCDE)



PRODUCT FINISHES

Smooth Felt Finish:

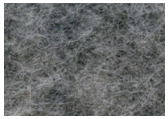

Pewter
(R5)



Lunar
(R6)



River Rock
(QT)

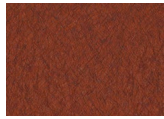

Sumac
(QS)



Admiral Blue
(QR)

PRODUCT OPTIONS

Height	Modesty Base Height	Width	Smooth Felt Finish	Hardware Finish
42 42 Datum Height 47 47 Datum Height	L Slim (24") T Semi (19")	54	Smooth Felt Finish	Foundation Mica

PRICING

Code	Product Name	Dimensions	Price
CQCDE	Smooth Felt Double End Screen	42" or 47"h x 54"w	335

routes screens

smooth felt study carrel (CQCSC)

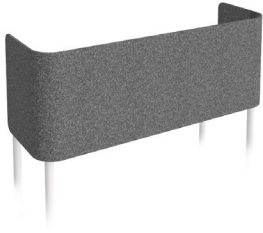

PRODUCT FINISHES

Smooth Felt Finish:

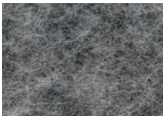

Pewter
(R5)



Lunar
(R6)



River Rock
(QT)

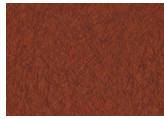

Sumac
(QS)



Admiral Blue
(QR)

PRODUCT OPTIONS

Height	Modesty Base Height	Width	Depth	Smooth Felt Finish	Hardware Finish
42 42 Datum Height 47 47 Datum Height	L Slim (24") T Semi (19")	60, 72	20	Smooth Felt Finish	Foundation Mica

PRICING

Code	Product Name	Dimensions	Price
CQCSC	Smooth Felt Study Carrel	42" or 47"h x 60" or 72"w x 20"d	565

routes storage overview

PERSONAL TOTE

Personal Totes are mobile and provide storage space below the worksurface for work bags and personal items.

Provides a mobile workable surface for use with Multi-Use Stools in collaborative settings.

Available with or without lock option.

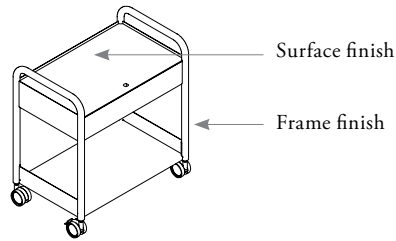
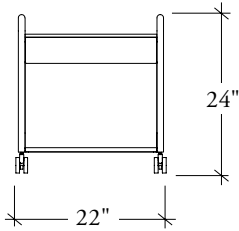

With Lock (Shown)

UTILITY CART

The Utility Cart provides versatile storage, perfect for smaller items like remotes, tech accessories, stationery, and cutlery. The included PET tote is free to move, enhancing flexibility. Sturdy wheels ensure easy mobility, making it ideal for keeping essentials organized and accessible.

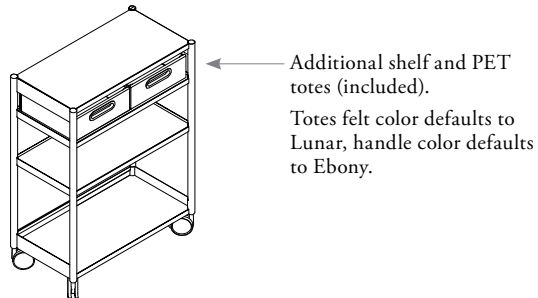
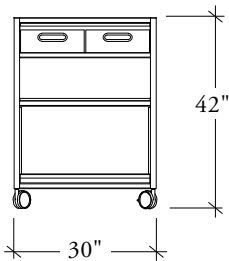

Additional shelf and PET totes (included).
Totes felt color defaults to Lunar, handle color defaults to Ebony.

SHARED TOTE

Shared Totes provide mobile open storage for individuals, for a team or to complement casual meeting areas.

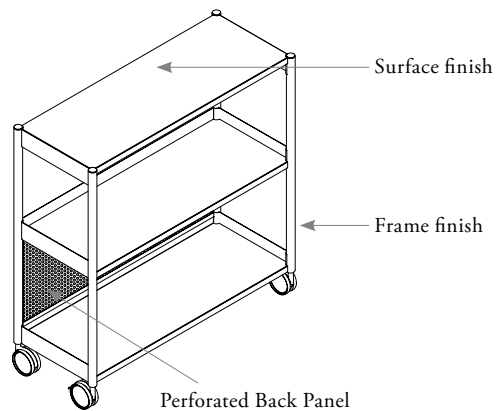
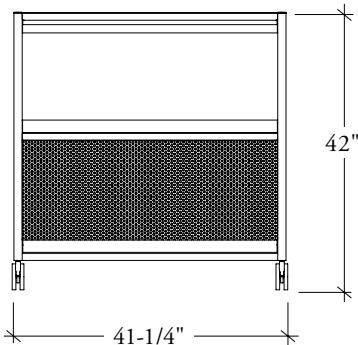

routes storage

personal tote (CQCPT)



PRODUCT OPTIONS

Drawer Lock	Depth	Width	Metal Frame Finish	Surface Finish	Key
N No Y Yes, Key Random	14	22	Foundation Mica Accent	Foundation Laminate Grade 2 Laminate	R Key Random

PRICING

Code	Product Name	Dimensions	Foundation Laminate	Grade 2 Laminate
CQCPT	Personal Tote, No Drawer Lock (N)	14"d x 22"w	552	579
	Personal Tote, Drawer Lock Key Random (Y)	14"d x 22"w	565	592

routes storage

utility cart (CQCMT)



PRODUCT OPTIONS

Height	Back Panel	Metal Frame Finish	Surface Finish
42	P Perforated	Foundation Mica Accent	Foundation Laminate Grade 2 Laminate

PRICING

Code	Product Name	Dimensions	Foundation Laminate	Grade 2 Laminate
CQCMT	Utility Cart	42"h	1870	1951

routes storage

shared tote (CQCST)



PRODUCT OPTIONS

Height	Back Panel	Metal Frame Finish	Surface Finish
42	P Perforated	Foundation Mica Accent	Foundation Laminate Grade 2 Laminate

PRICING

Code	Product Name	Dimensions	Foundation Laminate	Grade 2 Laminate
CQCST	Shared Tote	42"h	1294	1360

routes storage

coat stand (CQCCS)



PRODUCT FINISHES

Finish:



Sisal
(VM)

Greystone
(BR)

PRODUCT OPTIONS

Hardware Finish
VM Sisal BR Greystone

PRICING

Code	Product Name	Dimensions	Price
CQCCS	Coat Stand	70" h	512





routes work & tech boards overview

Work and Tech Boards can be used in a variety of meeting and training settings to provide writable and tackable surfaces and add technology. Work and Tech Boards can be specified with or without Add-On Boards.

WORK BOARDS

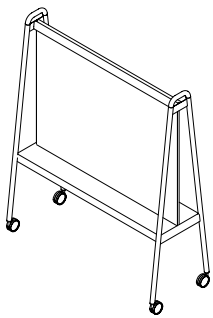

None
(CQCWBN)

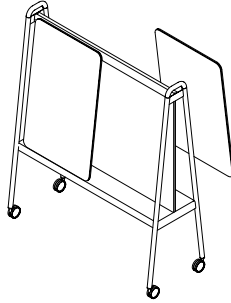

Two Whiteboards
(CQCWBW)

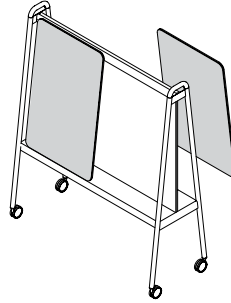

Two Tackboards
(CQCWBT)

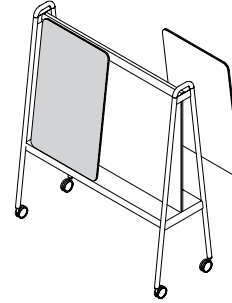

One Whiteboard and One Tackboard
(CQCWBU)

TECH BOARDS

The back side of the Tech Board is available with Whiteboard Laminate or non-writable Greystone Laminate.

Designed to accept TVs between 46" to 65", with a maximum weight of 50 lbs.

Includes a removable wire shroud that matches the selected Greystone or Whiteboard and wire management build into the flip down tray.

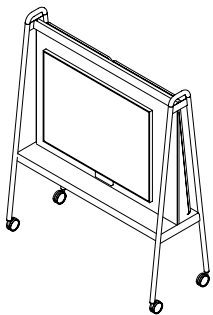

None
(CQCTBN)

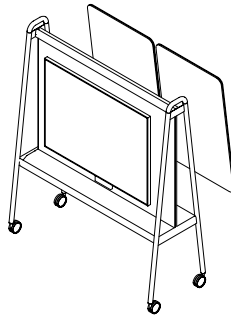

Two Whiteboards
(CQCTBW)

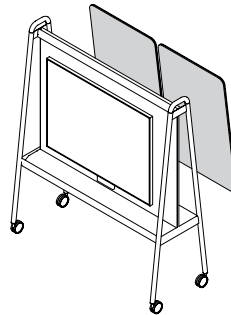

Two Tackboards
(CQCTBT)

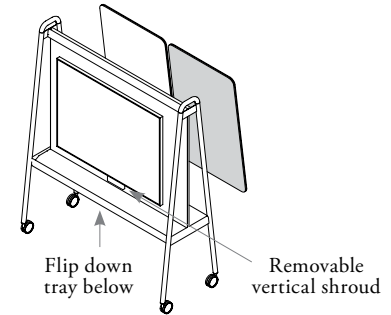

One Whiteboard and One Tackboard
(CQCTBU)

ADD-ON BOARDS

Add-On Boards can be specified separately or as an option when specifying the Work or Tech Board.

Up to four Add-On Boards can be placed on a Work Board, however Add-On Boards are light-weight and easy to handle, allowing users to have many of them that can be stored in an alternate location.

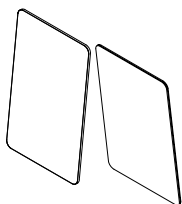

Two Whiteboard
Add-Ons
(CQCABW)

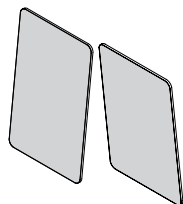

Two Tackboard
Add-Ons
(CQCABT)

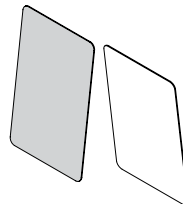

One Whiteboard and
One Tackboard Add-Ons
(CQCABU)

Fabric direction:

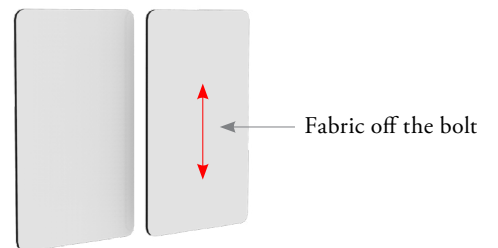

routes work & tech boards

work board [CQCWB]



PRODUCT OPTIONS

Add-On Board Configuration	Height	Width	Fixed Board Finish	Frame Finish	Tackboard Fabric
N None W Two Whiteboard Add-Ons T Two Tackboard Add-Ons U One Whiteboard and One Tackboard Add-On	77 77" height	64	5D Whiteboard Laminate	Foundation Mica Accent	Panel Fabrics Upholstery Fabrics

PRICING

Code	Product Name	Dimensions	NONE (N)								
CQCWB	Work Board	77"h x 64"w	1351								
			TWO TACKBOARD ADD-ONS (T)								
			Panel Fabric				Upholstery Fabric				
			COM	Gr. 1	COM	Gr. 1	Gr. 2	Gr. 3	Gr. 4	Gr. 5	Gr. 6
			1988	1991	1991	1991	2129	2292	2392	2492	2591
			ONE WHITEBOARD ADD-ON AND ONE TACKBOARD ADD-ON (U)								
			Panel Fabric				Upholstery Fabric				
			COM	Gr. 1	COM	Gr. 1	Gr. 2	Gr. 3	Gr. 4	Gr. 5	Gr. 6
			2093	2093	2093	2093	2150	2207	2257	2306	2357
			TWO WHITEBOARD ADD-ONS (W)								
			2193								

routes work & tech boards

tech board (CQCTB)



PRODUCT OPTIONS

Add-On Board Configuration	Height	Width	Technology Integration	Fixed Board Finish	Frame Finish	Tackboard Fabric
W Two Whiteboard Add-Ons T Two Tackboard Add-Ons U One Whiteboard and One Tackboard Add-On	77 77" height	64	S Vesa Screen Mount up to 65"	25 Greystone 5D Whiteboard Laminate	Foundation Mica Accent	Panel Fabrics Upholstery Fabrics

PRICING

Code	Product Name	Dimensions	NONE (N)								
CQCTB	Tech Board, Greystone Fixed Board	77"h x 64"w	1482								
			TWO TACKBOARD ADD-ONS (T)								
			Panel Fabric				Upholstery Fabric				
			COM	Gr. 1	COM	Gr. 1	Gr. 2	Gr. 3	Gr. 4	Gr. 5	Gr. 6
			2727	2729	2715	2729	2880	3031	3129	3228	3330
			ONE WHITEBOARD ADD-ON AND ONE TACKBOARD ADD-ON (U)								
			Panel Fabric				Upholstery Fabric				
			COM	Gr. 1	COM	Gr. 1	Gr. 2	Gr. 3	Gr. 4	Gr. 5	Gr. 6
			2925	2927	2914	2946	2994	3042	3092	3141	3193
			TWO WHITEBOARD ADD-ONS (W)								
2284											
CQCTB	Tech Board, Whiteboard Laminate Fixed Board	77"h x 64"w	NONE (N)								
			1556								
			TWO TACKBOARD ADD-ONS (T)								
			Panel Fabric				Upholstery Fabric				
			COM	Gr. 1	COM	Gr. 1	Gr. 2	Gr. 3	Gr. 4	Gr. 5	Gr. 6
			2800	2802	2788	2802	2953	3103	3202	3301	3403
			ONE WHITEBOARD ADD-ON AND ONE TACKBOARD ADD-ON (U)								
			Panel Fabric				Upholstery Fabric				
			COM	Gr. 1	COM	Gr. 1	Gr. 2	Gr. 3	Gr. 4	Gr. 5	Gr. 6
			2998	3000	2987	3018	3067	3115	3165	3214	3266
TWO WHITEBOARD ADD-ONS (W)											
2356											

routes work & tech boards

add-on board [CQCAB]



PRODUCT OPTIONS

Add-On Board Configuration	Tackboard Fabric	Whiteboard Finish
W Two Whiteboard Add-Ons T Two Tackboard Add-Ons U One Whiteboard and One Tackboard Add-On	Whiteboard Panel Fabrics Upholstery Fabrics	5D Whiteboard Laminate

PRICING

Code	Product Name	TWO TACKBOARD ADD-ONS (T)								
CQCAB	Add-On Board	Panel Fabric		Upholstery Fabric						
		COM	Gr. 1	COM	Gr. 1	Gr. 2	Gr. 3	Gr. 4	Gr. 5	Gr. 6
		638	640	625	640	791	941	1040	1139	1241
		ONE WHITEBOARD ADD-ON AND ONE TACKBOARD ADD-ON (U)								
		Panel Fabric		Upholstery Fabric						
		COM	Gr. 1	COM	Gr. 1	Gr. 2	Gr. 3	Gr. 4	Gr. 5	Gr. 6
		739	741	728	760	808	856	906	955	1007
		TWO WHITEBOARD ADD-ONS (W)								
		843								

routes media rover overview

The Media Rover creates an interactive digital experience between present and remote workers. It can be moved around the office easily to create a destination for digital collaboration.

- Accommodates a TV screen ranging from 43-50"
- Includes a webcam mounting bracket

DIMENSIONS

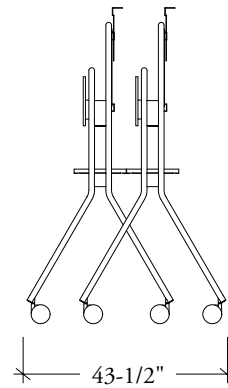
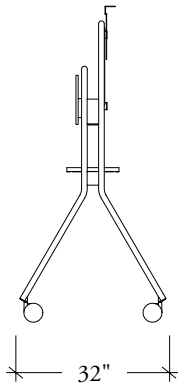
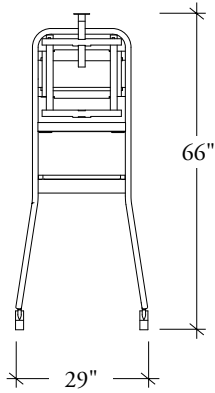

Can be ganged together for storage.

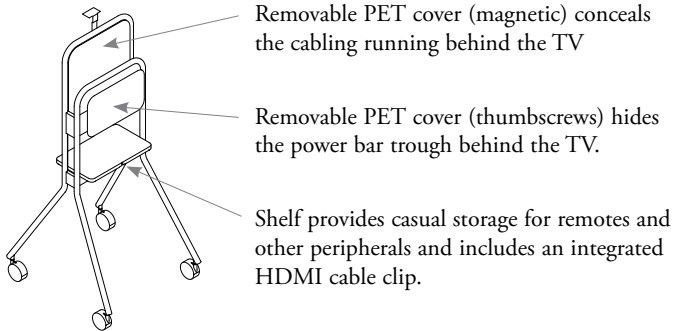

WEB CAMERA POSITION



Bar and Counter Height:

Webcam installed above the TV

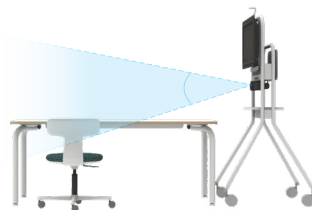

Task or Lounge Height:

Webcam installed below the TV

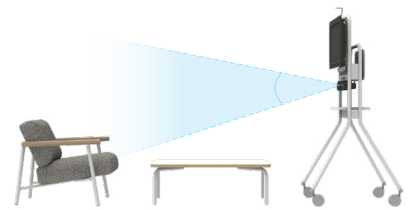

routes media rover

media rover (CQCMS)



PRODUCT FINISHES

Smooth Felt Finish:

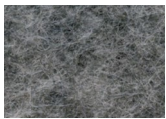

Pewter
(R5)



Lunar
(R6)



River Rock
(QT)

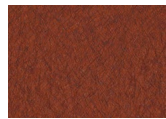

Sumac
(QS)

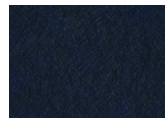

Admiral Blue
(QR)

PRODUCT OPTIONS

Height	Smooth Felt Back & Tray Finish	Frame Finish
66	Smooth Felt Colors	Foundation Mica Accent

PRICING

Code	Product Name	Dimensions	Price
CQCMS	Media Rover	29" d x 42-1/2" w x 66" h	1302



routes electrics & wire management overview

Routes Power Ports and Shared Power Hubs provide quick power, data or USB access.

Each includes a grey braided nylon cloth Power Cord in lengths of 72", 120", or 180".

Power Ports and Hubs cannot be daisy chained to each other, each unit must go directly to a floor monument or a wall outlet.

POWER PORTS

Routes Power Ports mount to single worksurfaces above or below the worksurface.

The following configurations are available.

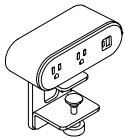

2 Power, 1 USB A&C,
Desk Edge Clamp

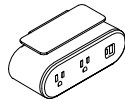

2 Power, 1 USB A&C,
Undermount Clamp

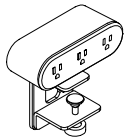

3 Power,
Desk Edge Clamp

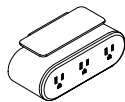

3 Power,
Undermount Clamp

SHARED POWER HUB

Routes Shared Power Hubs mount to the center of the underside of shared worksurfaces only. They can be accompanied by a Felt Cable Manager.

The following configuration is available.

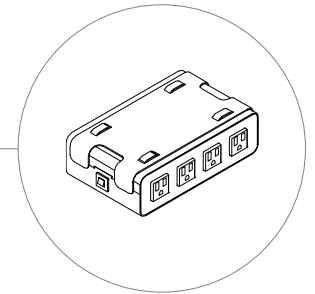
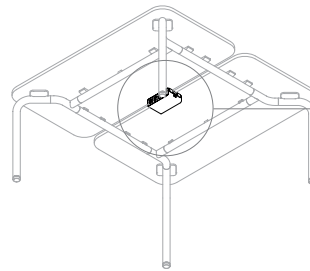

8 Power, Under
Worksurface Mount

CABLE MANAGEMENT STRAPS

All Routes Tables include four hook and loop cable management straps that secure cables anywhere along the tubular frame and route cables from the worksurface to the floor.

Each Strap is 15" long to secure multiple cables.

Additional cables can be easily added without removing the strap from its position on the tube.

Straps are double sided to provide two color options (dark and light) to coordinate with any frame color.

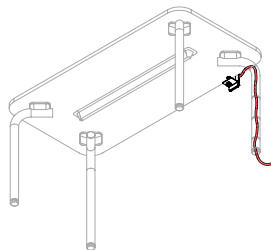
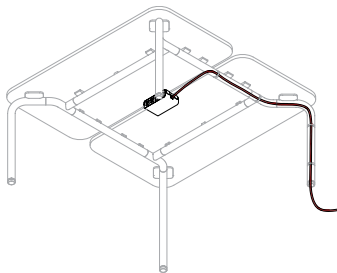

CABLE MANAGER

Felt Cable Manager is specified separately and is positioned in the following locations.

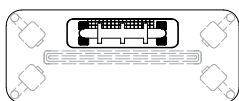

24" x 60" Worksurfaces

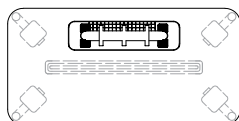

30" x 60" Worksurfaces

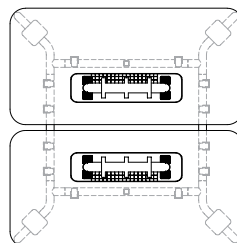

30" Deep Double Shared
Worksurfaces

routes electrics & wire management

power port (CQAMP)



PRODUCT FINISHES

Case & Front Finish:

Power Cord is a Grey reinforced braided nylon cloth.
For USB specifications refer to Complement YEPP Power Port

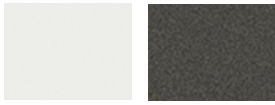

Atrium White
(20)

Anthracite
(68)

PRODUCT OPTIONS

Configuration	Mounting Option	Power Cord Length	Cord & Plug Type	Case & Front Finish
T3000 Triple - 3 Power	E Desk Edge Clamp	072, 120, 180	A Canada/USA Plug-In	20 Atrium White
T2110 Triple - 2 Power/1 USB A&C	U Undermount			68 Anthracite

PRICING

Code	Product Name	Dimensions	Price
CQAMP	Power Port, Triple - 3 Power (T3000)	72" Power Cord Length	218
		120" Power Cord Length	241
		180" Power Cord Length	264
	Power Port, Triple - 2 Power/1 USB A&C (T2110)	72" Power Cord Length	268
		120" Power Cord Length	288
		180" Power Cord Length	311

routes electrics & wire management

shared power hub (CQAPH)



PRODUCT FINISHES

Case & Front Finish:

Power Cord is a Grey reinforced braided nylon cloth.
For USB specifications refer to Complement YEPP Power Port

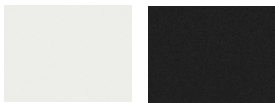

Atrium White (20) Foundry Onyx (23)

PRODUCT OPTIONS

Configuration	Mounting Option	Power Cord Length	Cord & Plug Type	Case & Front Finish
C8000 Outlet - 8 Power	U Under Worksurface	120, 216	A Canada/USA Plug-In	20 Atrium White 23 Foundry Onyx

PRICING

Code	Product Name	Dimensions	Price
CQAPH	Shared Power Hub	120" Power Cord Length	304
		216" Power Cord Length	359

routes electrics & wire management

cable manager (CQAWM)

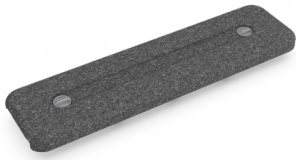

PRODUCT OPTIONS

Configuration	
01	Small Cable Organizer with Felt Cover
03	Large Cable Organizer with Felt Cover

PRICING

Code	Product Name	Price
CQAWM	Cable Manager	128

routes electrics & wire management

table lamp (CQATL)



PRODUCT FINISHES

Lamp Finish:

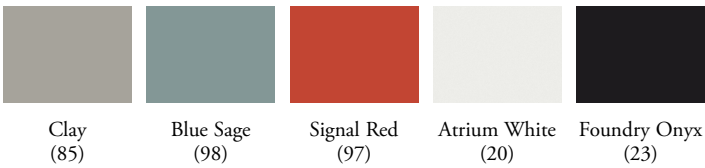

PRODUCT OPTIONS

Base Style	Hardware Finish	Country of Installation
1 Freestanding	20 Atrium White 23 Foundry Onyx 85 Clay 97 Signal Red 98 Blue Sage	A US & Canada

PRICING

Code	Product Name	Price
CQATL	Table Lamp	489





routes multi-use seating overview

Routes Multi-Use Seating is available in a variety of chair types.
All Routes chairs and stools have a weight capacity of 300 lbs.

multi-use stool
(CQSMF)

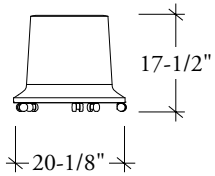

multi-use stool
with cushion
(CQSMU)

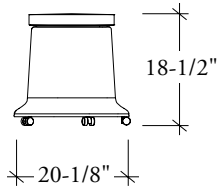

halo cushion
(CQSCP)

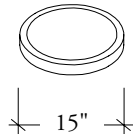

workshop chair
(CQSCT)

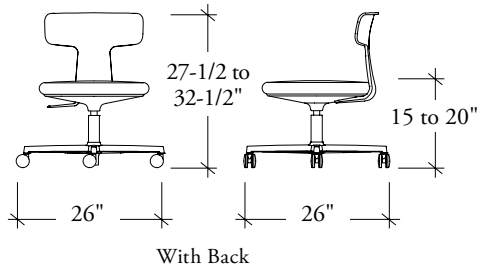
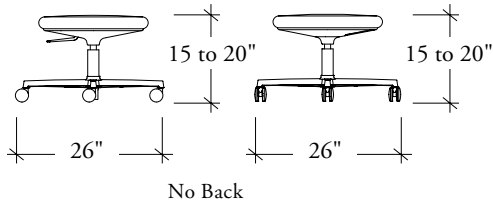

workshop stool
(CQSCH)

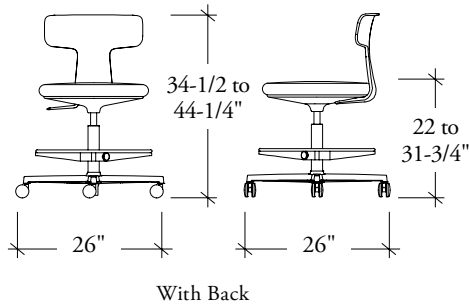
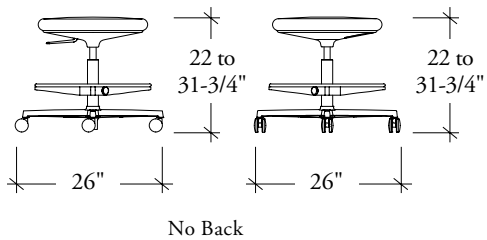

routes multi-use seating overview

tube chair (CQSTC)

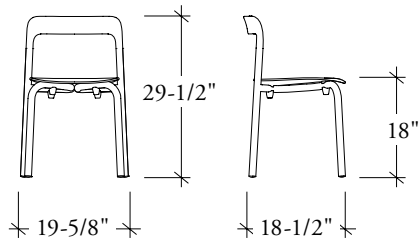

tube stool (CQSTF)

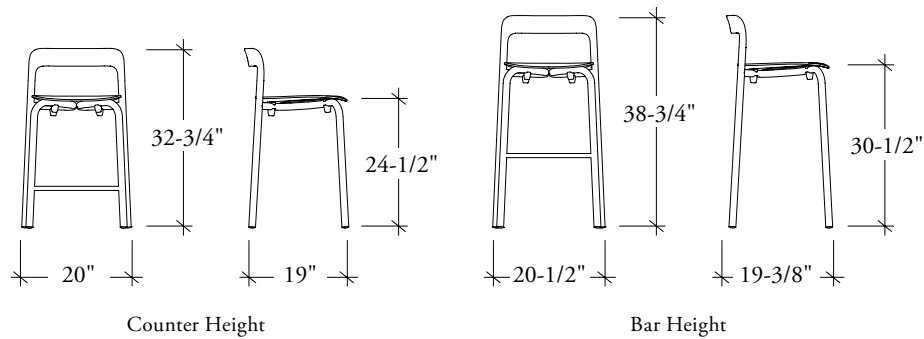

three-leg stool (CQSTS)

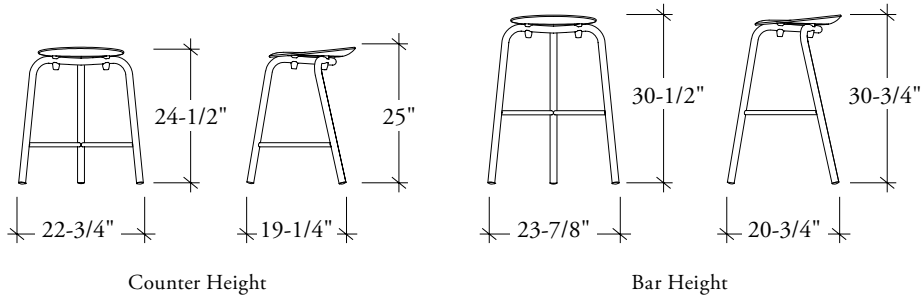

routes multi-use seating

multi-use stool [CQSMP]



Multi-Use Stools are available with and without cushion.
Halo Cushion is a loose cushion, specified separately.
Multi-Use Stools can be stacked up to ten high.
Remove cushion when stacking stools. It is not recommended that stacked stools be sat on.
The weight capacity is 300 lbs.

PRODUCT FINISHES

Plastic Seat Finish:

Cushion Upholstery: LUUM Fabric

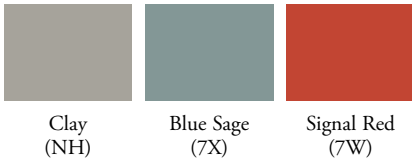

PRODUCT OPTIONS

Plastic Seat Finish		Caster Option
NH Clay	7X Blue Sage	Hard Caster
7W Signal Red		A Soft Caster

PRICING

Code	Product Name	Price
CQSMP	Multi-Use Stool	263

routes multi-use seating

multi-use stool with cushion (CQSMU)



PRODUCT FINISHES

Plastic Seat Finish:

Cushion Upholstery: LUUM Fabric

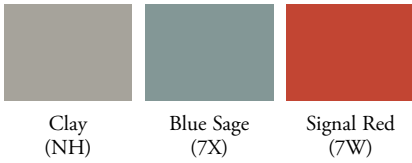

PRODUCT OPTIONS

Seat Upholstery	Plastic Seat Finish	Caster Option
Seating Fabric Leather	NH Clay 7X Blue Sage 7W Signal Red	Hard Caster A Soft Caster

PRICING

Code	Product Name	Gr. 1	COM/ Gr. 2	COL/ Gr. 3	Gr. 4	Gr. 5	Gr. 6	Gr. 7	Gr. 8	Gr. 9	Gr. 10	Leather LA	Leather LB	Leather LC	Leather LD
CQSMU	Multi-Use Stool with Cushion	370	379	394	409	423	436	455	469	484	499	514	528	543	560

routes multi-use seating

halo cushion (CQSCP)



PRODUCT FINISHES

Cushion Upholstery: LUUM Fabric

PRODUCT OPTIONS

Seat Upholstery
Seating Fabric Leather

PRICING

Code	Product Name	Gr. 1	COM/ Gr. 2	COL/ Gr. 3	Gr. 4	Gr. 5	Gr. 6	Gr. 7	Gr. 8	Gr. 9	Gr. 10	Leather LA	Leather LB	Leather LC	Leather LD
CQSCP	Halo Cushion	107	117	131	148	160	174	193	206	221	236	251	265	281	298

routes multi-use seating

Workshop Chairs and Stools are available with and without back.
The option with back is designed to accommodate 360° seating postures.
The weight capacity is 300 lbs.

workshop chair (CQSCCT)



No Back (N)



With Back (W)

workshop stool (CQSCH)



No Back (N)



With Back (W)

PRODUCT FINISHES

Frame Finish:

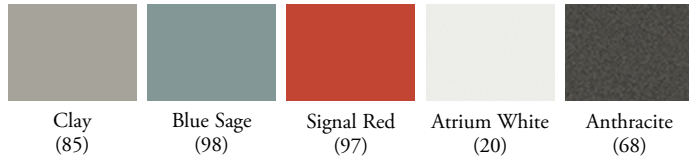

Seat Upholstery: LUUM Fabric

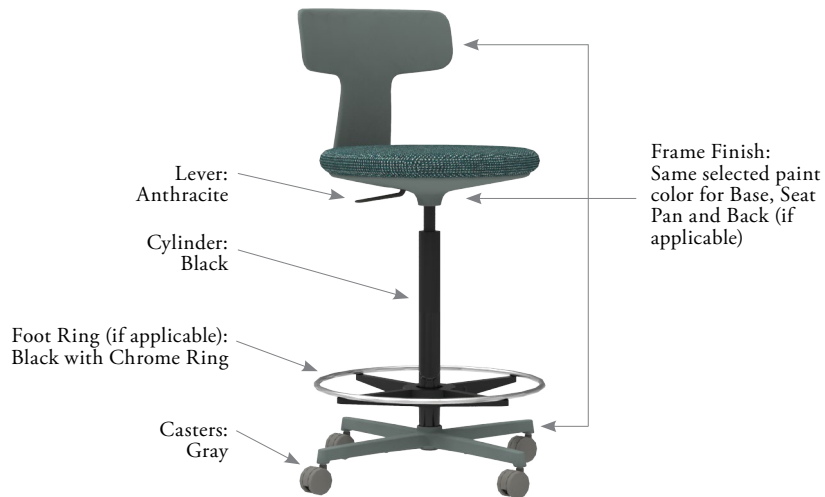

Pricing is on the following page.

routes multi-use seating

workshop chair (CQSCT) and workshop stool (CQSCH) (continued)

PRODUCT OPTIONS

Back Option	Seat Upholstery	Frame Finish	Caster Option
N No Back W With Back	Seating Fabric Leather	20 Atrium White 68 Anthracite 85 Clay 97 Signal Red 98 Blue Sage	Hard Caster A Soft Caster

PRICING

Code	Product Name	Gr. 1	COM/ Gr. 2	COL/ Gr. 3	Gr. 4	Gr. 5	Gr. 6	Gr. 7	Gr. 8	Gr. 9	Gr. 10	Leather LA	Leather LB	Leather LC	Leather LD
CQSCT	Workshop Chair, No Back (N)	572	572	601	613	630	646	656	672	688	701	718	731	747	761
	Workshop Chair, With Back (W)	627	627	655	668	684	700	710	726	743	755	773	785	801	815
CQSCH	Workshop Stool, No Back (N)	665	680	694	708	723	737	752	767	780	796	808	824	838	852
	Workshop Stool, With Back (W)	720	734	748	762	777	791	806	821	834	850	863	879	894	906

If Accent Frame Finish is specified, add 18

If Soft Casters (A) are specified, add 29

routes multi-use seating

tube chair (CQSTC)



Tube chairs are a tubular framed chair with a plastic seat.
 The weight capacity is 300 lb.
 Tube Chair and Tube Stool (CQSTC, CQSTF) can be stacked four high.
 Three-Leg Stool (CQSTS) can be stacked three high.

PRODUCT FINISHES

Frame Finish:

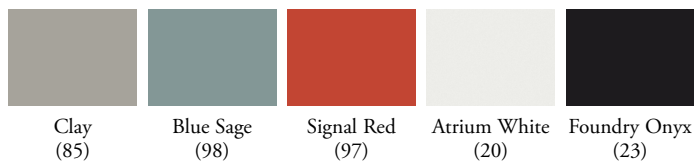

Plastic Seat Finish:

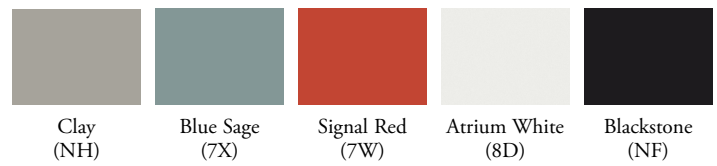

PRODUCT OPTIONS

Height Style	Frame Finish	Plastic Seat Finish
T Task Height	20 Atrium White 23 Foundry Onyx 85 Clay 97 Signal Red 98 Blue Sage	NH Clay 7X Blue Sage 7W Signal Red 8D Atrium White NF Blackstone

PRICING

Code	Product Name	Price
CQSTC	Tube Chair, Task Height (T)	512

routes multi-use seating

tube stool (CQSTF)

three-leg stool (CQSTS)



Counter Height

Bar Height



Counter Height

Bar Height

PRODUCT FINISHES

Frame Finish:

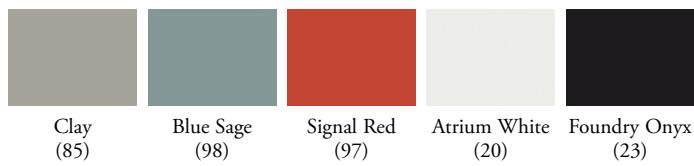

Plastic Seat Finish:

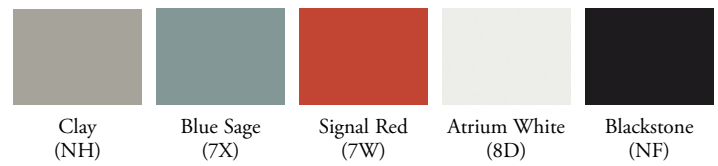

PRODUCT OPTIONS

Height Style	Frame Finish	Plastic Seat Finish
C Counter Height B Bar Height	20 Atrium White 23 Foundry Onyx 85 Clay 97 Signal Red 98 Blue Sage	NH Clay 7X Blue Sage 7W Signal Red 8D Atrium White NF Blackstone

PRICING

Code	Product Name	Price
CQSTF	Tube Stool, Counter Height (C)	512
	Tube Stool, Bar Height (B)	541
CQSTS	Three-Leg Stool, Counter Height (C)	398
	Three-Leg Stool, Bar Height (B)	409





routes soft seating overview

arc chair (CQSAC)

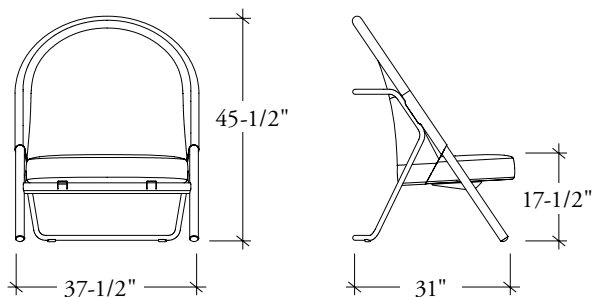

rocking chair (CQSRC)

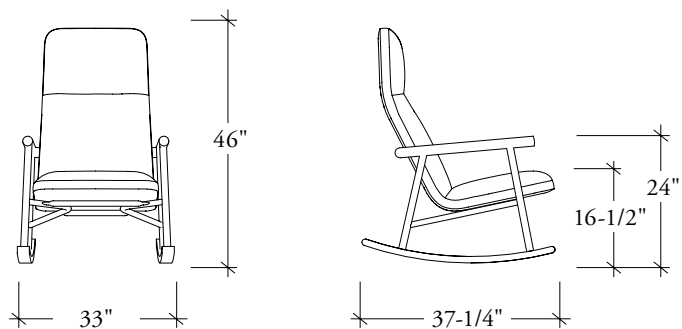

meet n greet chair (CQSMG)

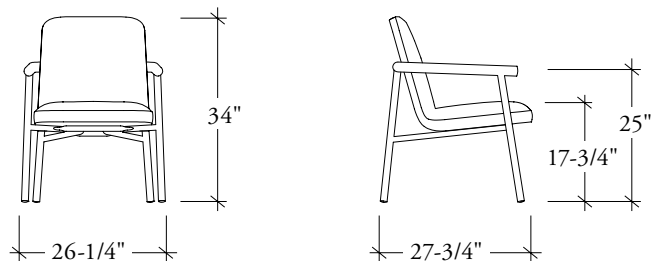

lounge chair (CQSLC)

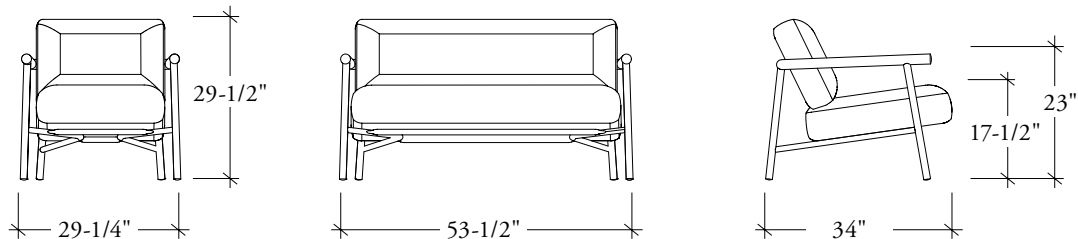

routes soft seating overview

sofa (CQSSU)

Low Back

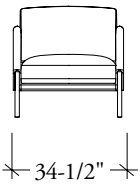
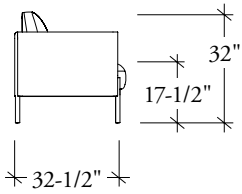

1-Seater

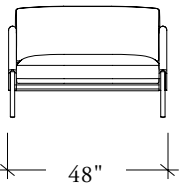

1.5-Seater

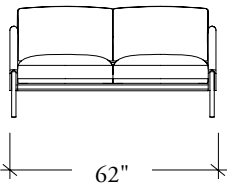

2-Seater

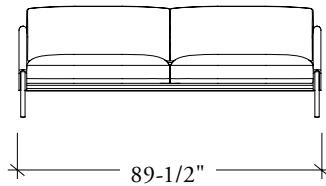

3-Seater with
2 Cushions

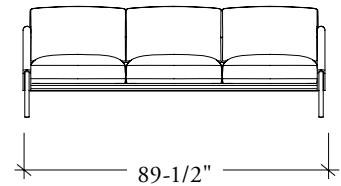

3-Seater with
3 Cushions

High Back

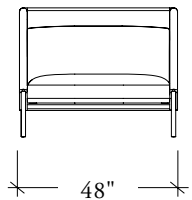
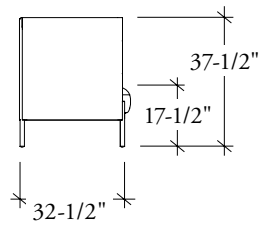

1.5-Seater

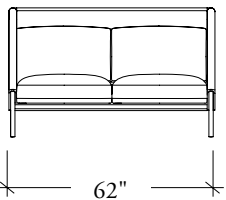

2-Seater

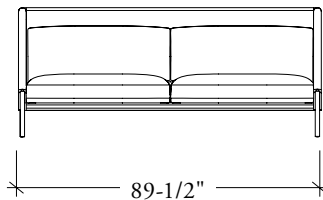

3-Seater with
2 Cushions

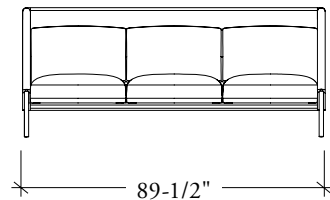

3-Seater with
3 Cushions

cushion (CQSCU)

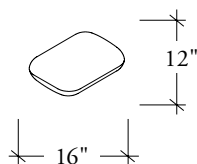
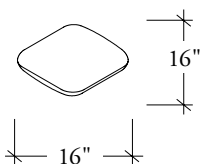

routes soft seating

arc chair (CQSAC)



PRODUCT FINISHES

Seat Upholstery:
Upholstery Fabric

Mesh Back Finish:



Midnight
(AR01)

Peppercorn
(AR02)

Metal Frame Finish:



Clay
(85)

Blue Sage
(98)

Signal Red
(97)

Atrium White
(20)

Foundry Onyx
(23)

PRODUCT OPTIONS

Mesh Back Finish	Upholstery Seat	Metal Frame Finish
AR01 Midnight AR02 Peppercorn	Upholstery Fabrics	20 Atrium White 23 Foundry Onyx 85 Clay 97 Signal Red 98 Blue Sage

PRICING

Code	Product Name	Gr. 1	COM/ Gr. 2	COL/ Gr. 3	Gr. 4	Gr. 5	Gr. 6	Gr. 7	Gr. 8	Gr. 9	Gr. 10
CQSAC	Arc Chair	1282	1318	1363	1409	1453	1499	1543	1590	1633	1680

routes soft seating

rocking chair (CQSRC)

meet n greet chair (CQSMG)



PRODUCT FINISHES

Seat Upholstery:
Upholstery Fabric

Metal Frame Finish:

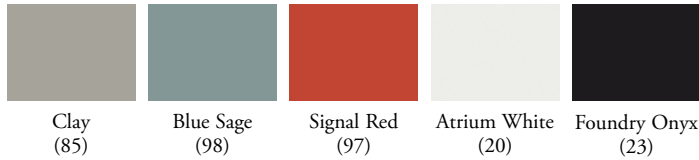

Wood Arm Finish:



PRODUCT OPTIONS

Arm Option	Upholstery Seat	Metal Frame Finish	Wood Arm & Base Finish
Y Yes	Upholstery Fabrics	20 Atrium White 23 Foundry Onyx 85 Clay 97 Signal Red 98 Blue Sage	VM Sisal DZ Truffle

PRICING

Code	Product Name	Gr. 1	COM/ Gr. 2	COL/ Gr. 3	Gr. 4	Gr. 5	Gr. 6	Gr. 7	Gr. 8	Gr. 9	Gr. 10
CQSRC	Rocking Chair, With Arms (Y)	1837	1901	1981	2061	2142	2222	2303	2382	2462	2545
CQSMG	Meet n Greet Chair, With Arms (Y)	1417	1473	1539	1607	1674	1741	1809	1875	1944	2010

routes soft seating

lounge chair (CQSLC)



PRODUCT FINISHES

Seat Upholstery:
Upholstery Fabric

Metal Frame Finish:

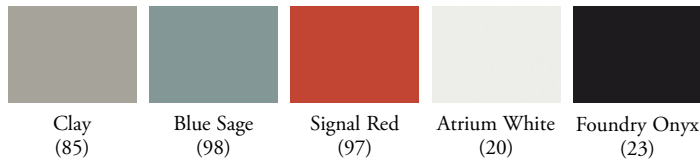

Wood Arm Finish:



PRODUCT OPTIONS

Size	Upholstery Seat	Metal Frame Finish	Wood Arm & Base Finish
1 1-Seater 2 2-Seater	Upholstery Fabrics	20 Atrium White 23 Foundry Onyx 85 Clay 97 Signal Red 98 Blue Sage	VM Sisal DZ Truffle

PRICING

Code	Product Name	Gr. 1	COM/ Gr. 2	COL/ Gr. 3	Gr. 4	Gr. 5	Gr. 6	Gr. 7	Gr. 8	Gr. 9	Gr. 10
CQSLC	Lounge Chair, 1-Seater (1)	1712	1777	1856	1937	2018	2099	2178	2258	2338	2419
	Lounge Chair, 2-Seater (2)	2605	2696	2809	2924	3037	3150	3265	3380	3494	3607

routes soft seating

sofa [CQSSL]

The Sofa has the same Routes tubular frame and a thin profile arm and separate back. Sofas are available in a variety of sizes with low and high back versions.

Sizes include: 1-Seater

1.5-Seater which provides a wider seat

2-Seater

3-Seater with 2 Cushions for a clean aesthetic and more spacious seat per user

3-Seater with 3 Cushions

Electrical options available: The power port (CQAMP) undermount option (U) can be specified separately for sofas. The outlets are available in both three powers (T3000) and two powers with 1 USB A&C (T2110). The mounting hardware is included.

Electrical position: The handedness can be decided on site.

Low Back (L)



1-Seater (A)



1.5-Seater (B)



2-Seater (C)



3-Seater with
2 Cushions (D)



3-Seater with
3 Cushions (E)

High Back (H)



1.5-Seater (B)



2-Seater (C)



3-Seater with
2 Cushions (D)



3-Seater with
3 Cushions (E)

For Single Upholstery (S), the seat, back cushions and surround are the same fabric.

For Dual Upholstery (D), the seat and back cushions are one fabric and the surround is a different fabric.

PRODUCT FINISHES

Seat and Back Upholstery:
Upholstery Fabric

Surround Upholstery (for Dual):
Upholstery Fabric

Metal Frame Finish:



Clay
(85)

Blue Sage
(98)

Signal Red
(97)

Atrium White
(20)

Foundry Onyx
(23)

routes soft seating

sofa (CQSSL) (continued)

PRODUCT OPTIONS

Surround Height	Size	Upholstery Style	Seat & Back Upholstery Finish	Metal Frame Finish
L Low H High	A 1-Seater B 1.5-Seater C 2-Seater D 3-Seater with 2 cushions E 3-Seater with 3 cushions	S Single Upholstery	Upholstery Fabrics	20 Atrium White 23 Foundry Onyx 85 Clay 97 Signal Red 98 Blue Sage

PRICING

Size	SEAT AND BACK, SINGLE UPHOLSTERY (S)									
	Gr. 1	COM/ Gr. 2	Gr. 3	Gr. 4	Gr. 5	Gr. 6	Gr. 7	Gr. 8	Gr. 9	Gr. 10
	Low Back (L)									
1-Seater (A)	3248	3415	3584	3754	3922	4092	4259	4429	4597	4768
1.5-Seater (B)	3751	3934	4120	4306	4490	4676	4860	5045	5230	5416
2-Seater (C)	4281	4567	4858	5145	5436	5724	6012	6303	6590	6879
3-Seater with 2 Cushions (D)	5332	5681	6029	6377	6728	7076	7425	7774	8122	8470
3-Seater with 3 Cushions (E)	5468	5856	6250	6642	7035	7427	7820	8211	8604	8996
	High Back (H)									
1.5-Seater (B)	4330	4519	4709	4899	5090	5282	5473	5663	5853	6043
2-Seater (C)	4945	5266	5589	5909	6231	6553	6875	7195	7517	7839
3-Seater with 2 Cushions (D)	5869	6273	6676	7079	7483	7886	8288	8692	9096	9499
3-Seater with 3 Cushions (E)	6003	6450	6895	7344	7790	8236	8684	9131	9576	10025

If Dual Upholstery (D) is specified for 1-Seater, 1.5-Seater, 2-Seater, add 251

If Dual Upholstery (D) is specified for 3-Seater with 2 Cushions and 3-Seater with 3 Cushions, add 383

routes soft seating

cushion (CQSCU)



Square (S)



Rectangle (R)

PRODUCT FINISHES

Seat Upholstery:
Upholstery Fabric

PRODUCT OPTIONS

Shape		Upholstery Seat
S Square		Upholstery Fabrics
R Rectangle		

PRICING

Code	Product Name	Gr. 1	COM/ Gr. 2	Gr. 3	Gr. 4	Gr. 5	Gr. 6	Gr. 7	Gr. 8	Gr. 9	Gr. 10
CQSCU	Cushion	220	231	242	249	265	272	279	287	299	340

routes COM/COL requirements

The pattern, repeat and directionality of fabric may increase the amount of yardage required.

Leather quantities should always be rounded up to the next hide size, as yields vary from 60-80% and are affected by the quality, size and shape of the hide, and by the location and quantity of blemishes.

Code	Product Name	SINGLE UPHOLSTERY		TRIPLE UPHOLSTERY					
				Seat		Back		Screens/Armrests	
		COM (yards)	COL (sq. ft)	COM (yards)	COL (sq. ft)	COM (yards)	COL (sq. ft)	COM (yards)	COL (sq. ft)
CQSMU	Multi-Use Stool with Cushion	0.5	8.5	n/a	n/a	n/a	n/a	n/a	n/a
CQSCP	Halo Cushion	0.5	8.5	n/a	n/a	n/a	n/a	n/a	n/a
CQSCT	Workshop Chair	0.75	13	n/a	n/a	n/a	n/a	n/a	n/a
CQSCH	Workshop Stool	0.75	13	n/a	n/a	n/a	n/a	n/a	n/a
CQSAC	Arc Chair	1.5	19	n/a	n/a	n/a	n/a	n/a	n/a
CQSRC	Rocking Chair	2.5	26	n/a	n/a	n/a	n/a	n/a	n/a
CQSMG	Meet n Greet Chair	1.75	17	n/a	n/a	n/a	n/a	n/a	n/a
CQSLC1	Lounge Chair, 1-Seater	2.6	28	1.2	16	1.4	12	n/a	n/a
CQSLC2	Lounge Chair, 2-Seater	4	52	2.5	29	1.5	23	n/a	n/a
CQSSLLA	Sofa - Low Back, 1-Seater	6.5	83	1.5	16	1.38	14	3.63	53
CQSSLLB	Sofa - Low Back, 1.5-Seater	6.5	99	1.5	22	1.38	19	3.63	58
CQSSLLC	Sofa - Low Back, 2-Seater	10.5	124	3	32	2.75	28	4.75	64
CQSSLLD	Sofa - Low Back, 3-Seater w/ 2 Cushions	10.5	158	3	44	2.75	38	4.75	76
CQSSLLE	Sofa - Low Back, 3-Seater w/ 3 Cushions	13.25	166	4.5	48	4	42	4.75	76
CQSSLHB	Sofa -High Back, 1.5-Seater	8.25	119	1.5	22	1.38	19	5.37	78
CQSSLHC	Sofa - High Back, 2-Seater	13	144	3	32	2.75	28	7.25	84
CQSSLHD	Sofa - High Back, 3-Seater w/ 2 Cushions	13	182	3	44	2.75	38	7.25	100
CQSSLHE	Sofa - High Back, 3-Seater w/ 3 Cushions	15.75	190	4.5	48	4	42	7.25	100
CQSCU	Cushion	0.5	8.5	n/a	n/a	n/a	n/a	n/a	n/a

teknion

www.teknion.com

CAN/US/INT 01-27

©Teknion 2025

®, ™ trade marks of Teknion Corporation
and/or its subsidiaries or licensed to it.
Patents may be pending.

Some products may not be available in
all markets. Contact your local Teknion
Representative for availability.

JAN25-ROUTES