

routes multi-use seating overview

Routes Multi-Use Seating is available in a variety of chair types.
All Routes chairs and stools have a weight capacity of 300 lbs.

multi-use stool
(CQSMF)

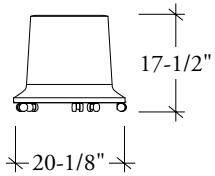

multi-use stool
with cushion
(CQSMU)

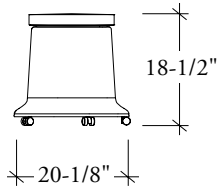

halo cushion
(CQSCP)

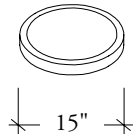

workshop chair
(CQSCT)

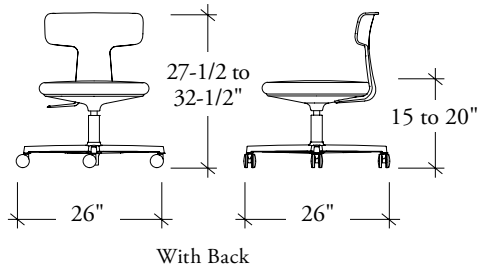
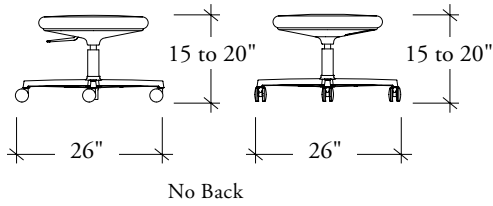

workshop stool
(CQSCH)

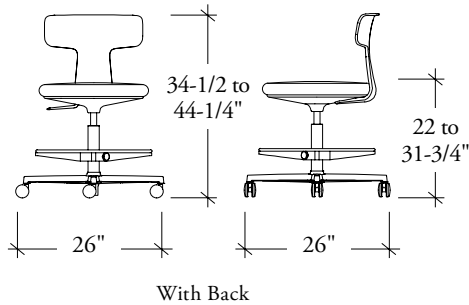
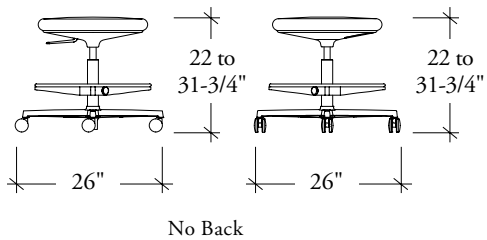

routes multi-use seating overview

tube chair (CQSTC)

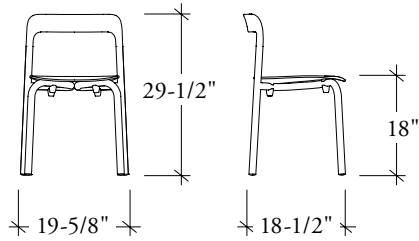

tube stool (CQSTF)

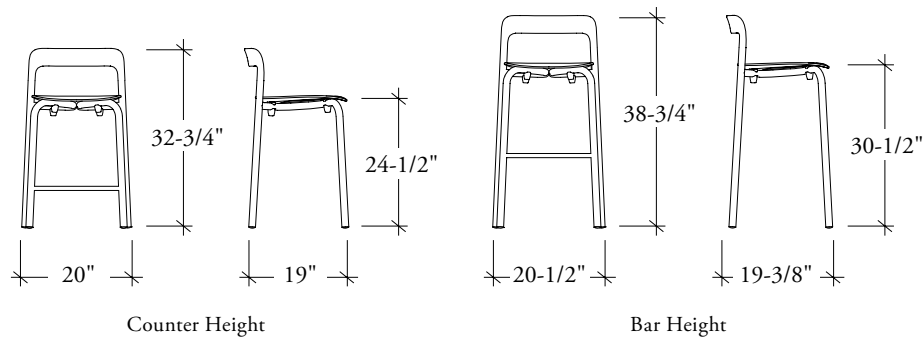

three-leg stool (CQSTS)

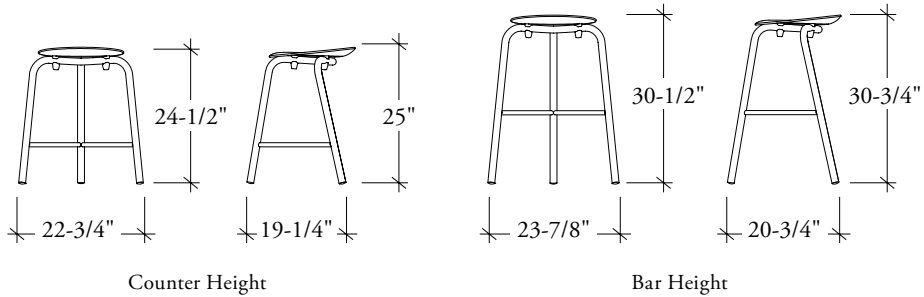

routes multi-use seating

multi-use stool [CQSMP]



Multi-Use Stools are available with and without cushion.
Halo Cushion is a loose cushion, specified separately.
Multi-Use Stools can be stacked up to ten high.
Remove cushion when stacking stools. It is not recommended that stacked stools be sat on.
The weight capacity is 300 lbs.

PRODUCT FINISHES

Plastic Seat Finish:

Cushion Upholstery: LUUM Fabric

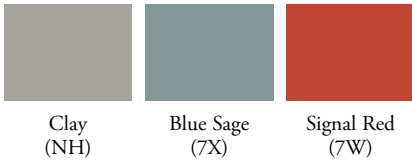

PRODUCT OPTIONS

Plastic Seat Finish		Caster Option
NH Clay	7X Blue Sage	Hard Caster
7W Signal Red		A Soft Caster

PRICING

Code	Product Name	Price
CQSMP	Multi-Use Stool	263

routes multi-use seating

multi-use stool with cushion (CQSMU)



PRODUCT FINISHES

Plastic Seat Finish:

Cushion Upholstery: LUUM Fabric

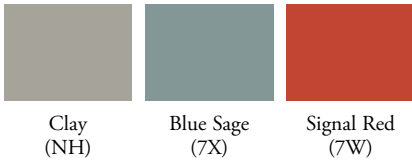

PRODUCT OPTIONS

Seat Upholstery	Plastic Seat Finish	Caster Option
Seating Fabric Leather	NH Clay 7X Blue Sage 7W Signal Red	Hard Caster A Soft Caster

PRICING

Code	Product Name	Gr. 1	COM/ Gr. 2	COL/ Gr. 3	Gr. 4	Gr. 5	Gr. 6	Gr. 7	Gr. 8	Gr. 9	Gr. 10	Leather LA	Leather LB	Leather LC	Leather LD
CQSMU	Multi-Use Stool with Cushion	370	379	394	409	423	436	455	469	484	499	514	528	543	560

routes multi-use seating

halo cushion (CQSCP)



PRODUCT FINISHES

Cushion Upholstery: LUUM Fabric

PRODUCT OPTIONS

Seat Upholstery
Seating Fabric Leather

PRICING

Code	Product Name	Gr. 1	COM/ Gr. 2	COL/ Gr. 3	Gr. 4	Gr. 5	Gr. 6	Gr. 7	Gr. 8	Gr. 9	Gr. 10	Leather LA	Leather LB	Leather LC	Leather LD
CQSCP	Halo Cushion	107	117	131	148	160	174	193	206	221	236	251	265	281	298

routes multi-use seating

Workshop Chairs and Stools are available with and without back.
The option with back is designed to accommodate 360° seating postures.
The weight capacity is 300 lbs.

workshop chair (CQSCCT)



No Back (N)



With Back (W)

workshop stool (CQSCH)



No Back (N)



With Back (W)

PRODUCT FINISHES

Frame Finish:

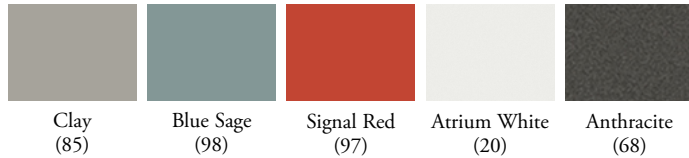

Seat Upholstery: LUUM Fabric

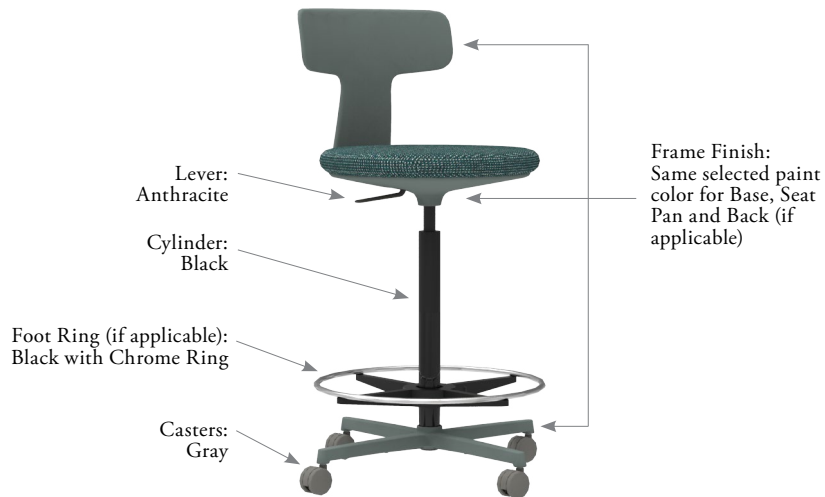

Pricing is on the following page.

routes multi-use seating

workshop chair (CQSCT) and workshop stool (CQSCH) (continued)

PRODUCT OPTIONS

Back Option	Seat Upholstery	Frame Finish	Caster Option
N No Back W With Back	Seating Fabric Leather	20 Atrium White 68 Anthracite 85 Clay 97 Signal Red 98 Blue Sage	Hard Caster A Soft Caster

PRICING

Code	Product Name	Gr. 1	COM/ Gr. 2	COL/ Gr. 3	Gr. 4	Gr. 5	Gr. 6	Gr. 7	Gr. 8	Gr. 9	Gr. 10	Leather LA	Leather LB	Leather LC	Leather LD
CQSCT	Workshop Chair, No Back (N)	572	572	601	613	630	646	656	672	688	701	718	731	747	761
	Workshop Chair, With Back (W)	627	627	655	668	684	700	710	726	743	755	773	785	801	815
CQSCH	Workshop Stool, No Back (N)	665	680	694	708	723	737	752	767	780	796	808	824	838	852
	Workshop Stool, With Back (W)	720	734	748	762	777	791	806	821	834	850	863	879	894	906

If Accent Frame Finish is specified, add 18

If Soft Casters (A) are specified, add 29

routes multi-use seating

tube chair (CQSTC)



Tube chairs are a tubular framed chair with a plastic seat.
 The weight capacity is 300 lb.
 Tube Chair and Tube Stool (CQSTC, CQSTF) can be stacked four high.
 Three-Leg Stool (CQSTS) can be stacked three high.

PRODUCT FINISHES

Frame Finish:

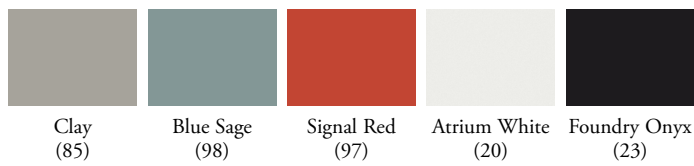

Plastic Seat Finish:

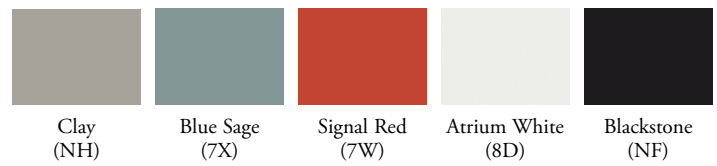

PRODUCT OPTIONS

Height Style	Frame Finish	Plastic Seat Finish
T Task Height	20 Atrium White 23 Foundry Onyx 85 Clay 97 Signal Red 98 Blue Sage	NH Clay 7X Blue Sage 7W Signal Red 8D Atrium White NF Blackstone

PRICING

Code	Product Name	Price
CQSTC	Tube Chair, Task Height (T)	512

routes multi-use seating

tube stool (CQSTF)

three-leg stool (CQSTS)



Counter Height

Bar Height



Counter Height

Bar Height

PRODUCT FINISHES

Frame Finish:

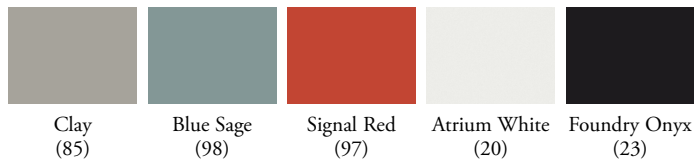

Plastic Seat Finish:

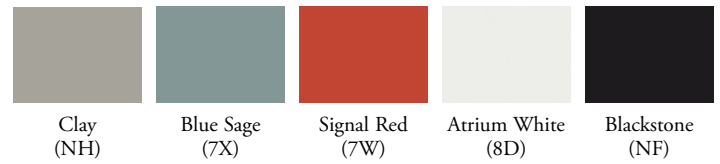

PRODUCT OPTIONS

Height Style	Frame Finish	Plastic Seat Finish
C Counter Height B Bar Height	20 Atrium White 23 Foundry Onyx 85 Clay 97 Signal Red 98 Blue Sage	NH Clay 7X Blue Sage 7W Signal Red 8D Atrium White NF Blackstone

PRICING

Code	Product Name	Price
CQSTF	Tube Stool, Counter Height (C)	512
	Tube Stool, Bar Height (B)	541
CQSTS	Three-Leg Stool, Counter Height (C)	398
	Three-Leg Stool, Bar Height (B)	409



