

accessories

UNDERSTANDING ACCESSORIES	108
ACCESSORY BASICS	110
PLANNING WITH ACCESSORIES	
PLANNING WITH RECESSED LED LIGHT (CEALD)	113
PLANNING WITH UNDERCABINET ACCESSORY SHELF (CEAUS)	113
PLANNING WITH UNDERCABINET CUBBY (CEAUC)	114
PLANNING WITH WALL-MOUNTED CUBBY (CEAWC)	115
PLANNING WITH WALL-MOUNTED SHELF (CEAWS)	116
PLANNING WITH WALL SHELVING UNIT – METAL FRAME & – SHELF	117
PLANNING WITH DRAWER ORGANIZERS	118
PLANNING WITH SYMBOL IDENTIFICATIONS	119

understanding accessories

Expansion Casework+ Accessories are used to enhance functionality and add a finishing touch to Expansion Casework+ layouts.

Accessories

- Sixteen accessories are available:

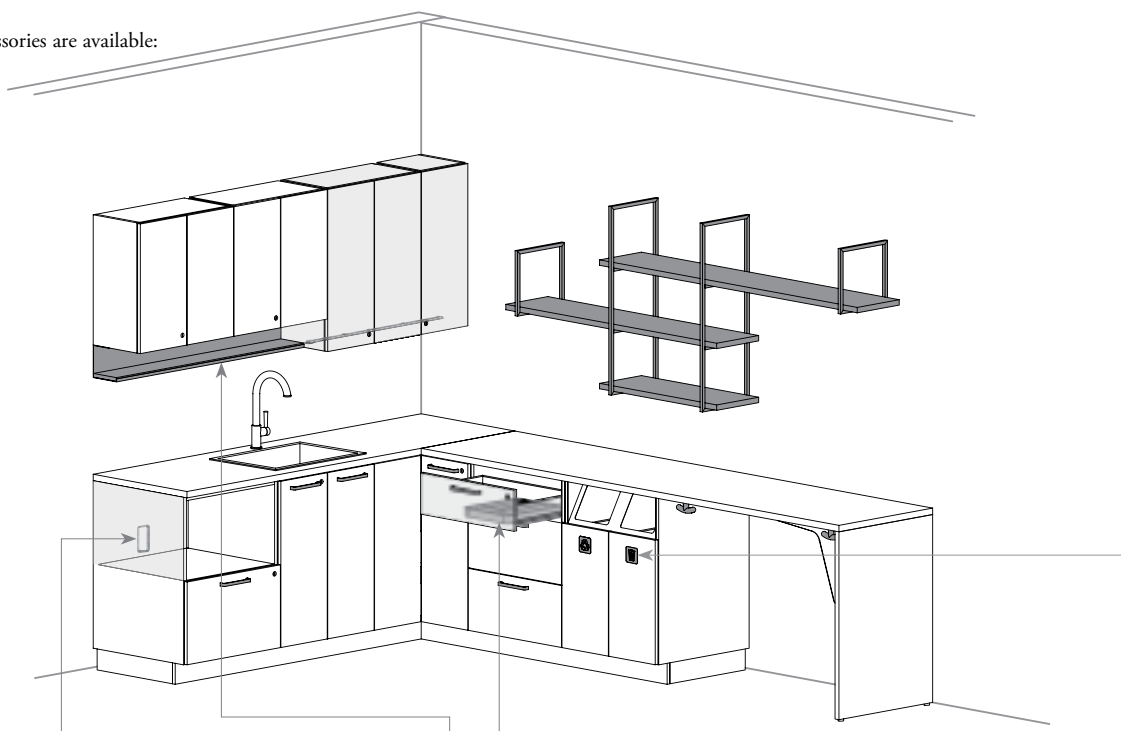

Pass-Through Grommet (CEAGR)

- Provides finition when electrical cable opening of cabinet is cut on-site
- Included when With Pass-Through Grommet Cut-Out Style is specified
- To be used when a cut-out is made on-site to access wall outlets



Undercabinet Accessory Shelf (CEAUS)

- Provides additional open storage under Upper Cabinets
- Metal shelf with 11/16" thick laminate inlay

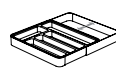

Drawer Organizer – Cutlery Tray (CEAOT)

- Retractable plastic tray for kitchen cutlery

OR



Drawer Organizer – Utility Box (CEAOB)

- Metal tray with one adjustable divider
- Available in two depths to fit inside Standard – Soft-Close (16) or Undermount – Soft-Close (20) Drawer Depth



Recycling/Disposal Symbol (CEASR)

- A great way to personalize a kitchen and indicate the cabinet function
- Metal plate identifications for Base or Storage Cabinet – Recycling/Disposal Center/Units

Also Available:

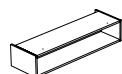

Undercabinet Cubby (CEAUC)

- Provide additional open storage under Upper Cabinets
- Cubby is 11/16" thick

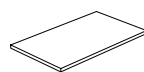

Shelf for Cabinet (CEACS)

- To add shelving space in most of cabinets
- 11/16" thick

For Grain Direction; see page 132

For Edge Trim Styles; see page 134

understanding accessories (continued)

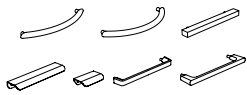
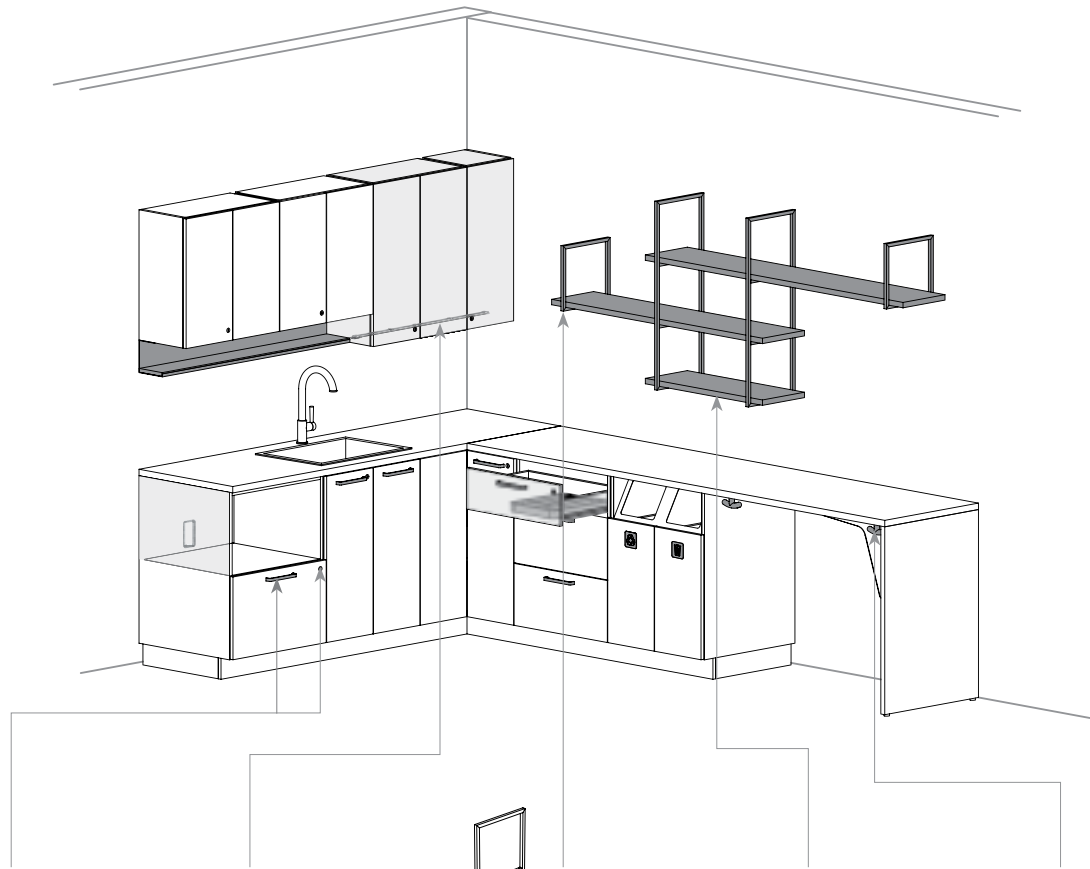

Pull (CEAP)

- Offered as a replacement part
- Included with cabinets when specified

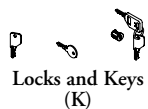

Locks and Keys (K)

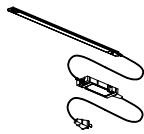

Recessed LED Light (CEALED)

- Installs under Upper Cabinets when Light Management (groove) is specified
- Two Plug Options are available:
 - Standard Plug-In (P)
 - Hardwire (H)

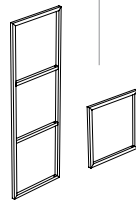

Wall Shelving Unit – Metal Frame (CEASF)

- Allows flexibility for wall mounting shelf layout
- Must be specified with Wall Shelving Unit – Shelf (CEASS)
- 5/8" thick square tube (actual depth)

Also Available:

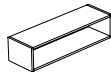

Wall-Mounted Cubby (CEAWC)

- Provides additional open storage. Can be used alone or between cabinets
- Cubby is 1" thick



Wall Shelving Unit – Shelf (CEASS)

- Must be specified with Wall Shelving Unit – Metal Frame (CEASF)
- 1" thick (actual width)

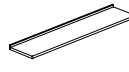

Wall-Mounted Shelf (CEAWS)

- Allows flexibility for wall mounting shelf layout
- 1" thick with metal support



Hook – Double-Sided (CEAHW)

- Can add functionality under the countertop



Hook – Single-Sided (CEAHK)

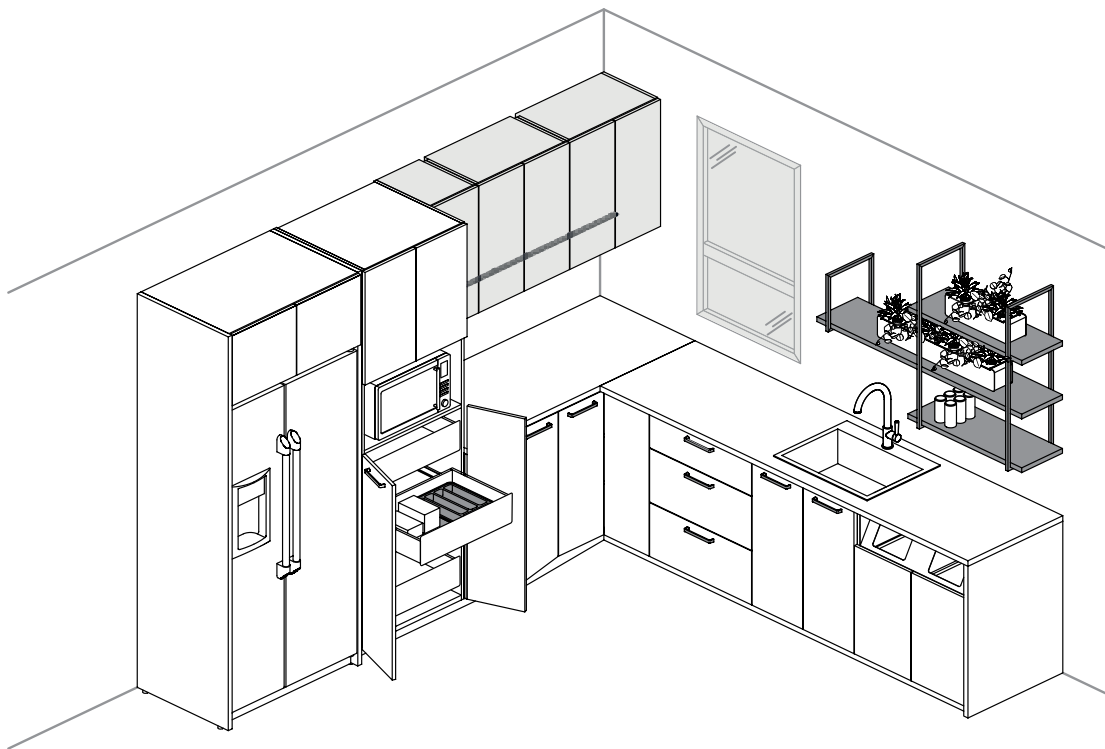

Recessed LED Light (CEALED)

- Widths: 24" to 366 (3" increments)
- LED Light is 3000K, a milky lens is included
- Option Feature: Each light comes with its own Driver and Integrated Dimmable Switch (D) (located at the end of the LED Light)
- Equipped with an energy-efficient strip of LEDs
- Life expectancy of 50 000 hours
- Plug Options:
 - Standard Plug-In (P)
 - Hardwire (H)
- Country of Installation: Canada/U.S.A. (A). For countries other than those listed, contact Teknion's Customer Service
- **Finish:**
Light profile is finished Anodized Aluminum

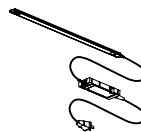

Undercabinet Accessory Shelf (CEAUS)

- Depth: 6"
- Widths: 24" to 90" (3" increments)
- Heights: 6" and 9"
- **Finishes:**
Shelf is finished in Source Laminate, Foundation Laminate, Grade 2 Laminate or Flintwood (No Cathedral)*
Edge Trims are finished in Edge Trim Colors or Not Applicable**
Shelf Support is finished in Foundation, Accent or Mica

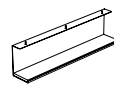

accessories basics (continued)

Undercabinet Cubby (CEAUC)

- Depths: 12" and 15"
- Widths: 24" to 90" (3" increments)
- Height: 9"
- **Finishes:**
Case & Back Panel are finished in Source Laminate or Flintwood (No Cathedral)*

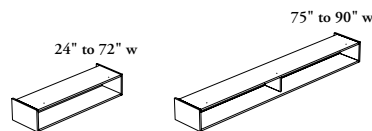

Wall-Mounted Cubby (CEAWC)

- Depths: 9", 12" and 15"
- Widths: 36" to 90" (3" increments)
- Heights: 9" and 12"
- **Finishes:**
Case & Back Panel are finished in Source Laminate or Flintwood (No Cathedral)*

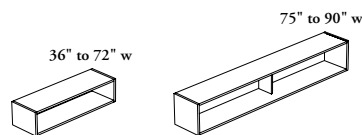

Wall-Mounted Shelf (CEAWS)

- Depth: 9"
- Widths: 36" to 90" (3" increments)
- **Finishes:**
Shelf is finished in Source Laminate, Foundation Laminate, Grade 2 Laminate or Flintwood (No Cathedral)*
Edge Trims are finished in Edge Trim Colors (for trim style 8 or F) or Not Applicable**
Shelf Hardware is finished in Foundation, Accent or Mica

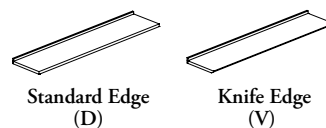

Wall Shelving Unit – Metal Frame (CEASF)

- Depth: 12" (actual depth)
- **Finishes:** Foundation, Accent or Mica

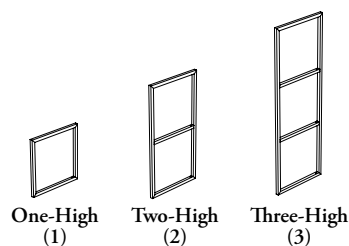

Wall Shelving Unit – Shelf (CEASS)

- Widths: 24" to 105" (3" increments) (actual width)
- Depth: 12"
- **Finishes:**
Shelf is finished in Source Laminate, Foundation Laminate, Grade 2 Laminate or Flintwood (No Cathedral)*
Edge Trims are finished in Edge Trim Colors or Not Applicable**

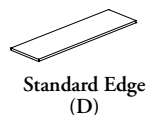

Drawer Organizers – Cutlery Tray (CEAOT)

- Made in two pieces and can extend up to 21" width
- Dimensions: 12" to 21" w X 15" d X 2" h
- Can be fitted in 16" or 20" deep drawers
- **Finish:** Grey Plastic

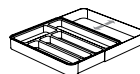

Drawer Organizer – Utility Box (CEAOB)

- Width: 6"
- Depths: 12" and 20"
- Can be fitted on 16" or 20" deep drawers
- **Finishes:**
Foundation, Accent or Mica
To match the color of the drawer body, Very White should be specified

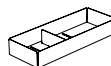

* Restrictions apply with this finish, refer to individual product pages for details

** Not Applicable (NA) option is only available when Flintwood Front Finishes are specified

accessories basics (continued)

Recycling/Disposal Symbol (CEASR)

- Installs on cabinet with Identification Symbol Ready (S) option
- Dimension: 2 1/2" w X 2 1/2" h
- **Finishes:**
Front and Back Plate are finished Foundation, Accent or Mica

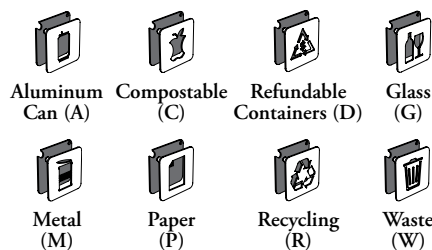

Hook – Single-Sided (CEAHK)

- This hook can be installed anywhere under the countertop
- **Finishes:** Foundation, Accent or Mica



Hook – Double-Sided (CEAHW)

- This hook can be installed anywhere under the countertop
- **Finishes:** Foundation, Accent or Mica



Shelf for Cabinet (CEACS)

- Widths: 12", 15", 24" and 29"
- Cabinet Widths: 12" to 60" (3" increments)
- Widths larger than 36" come with two parts
- When 24" or 29" Cabinet Depth is specified, 45" to 60" Cabinet Widths are **not** available
- Shelf Supports are included
- Compatible with:
 - Upper Cabinets (CEUO, CEUS, CEUG, CEUMS, CEUPO, CEUPS, CEUCS, CEUCG)
 - Base Cabinets (CEBO, CEBS, CEBDS, CEBCBS)
 - Storage Cabinets (CETO, CETS, CETT, CETD, CEMS, CEMD)
- **Finishes:** Source Laminate or Flintwood (No Cathedral)*

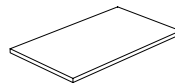

Pass-Through Grommet (CEAGR)

- Grommet is always included when With Pass-Through Grommet (W) Cut-Out Style is specified with cabinets listed below:
 - Upper Cabinet – Microwave Section and Doors (CEUMS)
 - Base Cabinet – Microwave Section with Drawer (CEBMD)
 - Tall Cabinets – Microwave Section(s) (CEMS and CEMD)
 - Countertop Cabinet – Microwave Section(s) and Doors (CECM)
- **Finish:** Platinum Coordinate



Pull (CEAP)

- For more details on Pull Styles, refer to page 120
- **Finishes (If Applicable):** Foundation, Accent or Mica

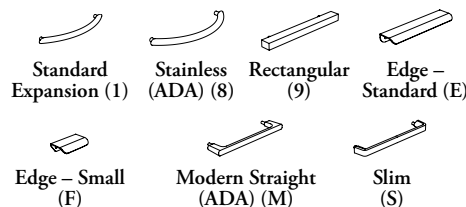

Locks and Keys (K)

- The Master Key (M) unlocks any storage unit
- The Lock Removal Key (R) removes lock core from storage units
- Lock Core and Keys (C) are replacements for those currently installed
- **Finish:** Brushed Chrome

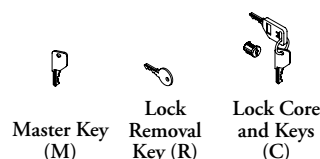

* Restrictions apply with this finish, refer to individual product pages for details

planning with accessories

planning with recessed LED light (CEALED)

- Installs under Upper Cabinet when Light Management (groove connection) is specified. Refer to Upper Cabinets section for details
- Two Plug Options:
 - Standard Plug-In (P) to connect a standard wall outlet
 - Hardwire (H) for a permanent installation
- The wire is 78 3/4" long in both specifications
- Hardware connection must be executed by qualified electrician
- A driver support is provided and can be installed in the gap between the wall and the Upper Cabinet. It is the installer's responsibility to properly position the driver in the layout to comply with local regulations

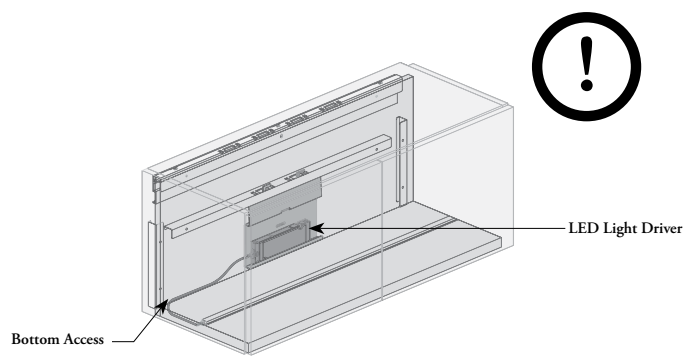
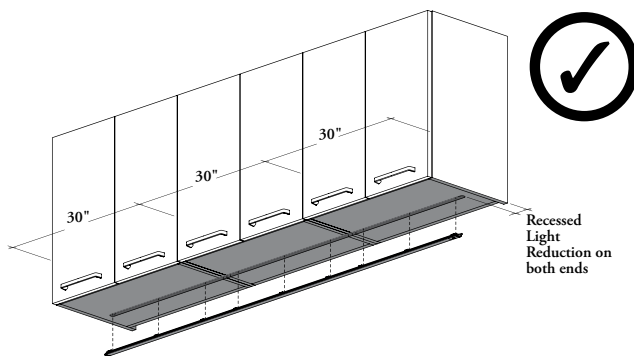

- Must be specified to match the same width as the Upper Cabinet under which it will be installed
 - **Example:** under 3 x 30" wide cabinets = 90" wide, recessed light reduction is already applied within the specified width

WARNING: Once installed, the LED driver always needs to be accessible without tools, by a cut-out (cut on-site) inside the cabinet or by the bottom access of Upper Cabinets. This access should **never** be blocked by any added accessories

planning with undercabinet accessory shelf (CEAUS)

- Can be installed on- or off-module under all Upper Cabinets
- Can overlap multiple Upper Cabinets
- Can be used in the layout with cabinets of different heights:
 - Shelf height can be specified to align with the bottom of the cabinet next to it
- The Undercabinet Accessory Shelf (CEAUS) should **never** block the access to the Recessed LED Light driver, see **WARNING** illustrated above

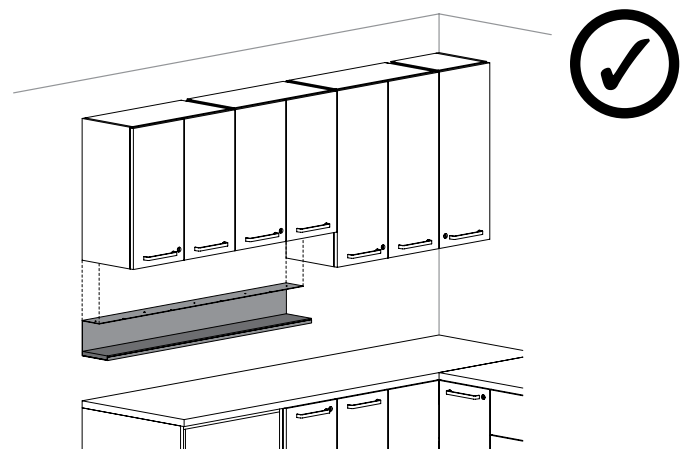

planning with accessories (continued)

planning with undercabinet cubby (CEAUC)

- Can be used in the layout with cabinets of different heights:
 - The cubby height correspond to the height difference between cabinets when specified with 9-inch variation
- Compatible with all Upper Cabinets except an Upper Cabinet for Blind Corner (CEUCS or CEUCG)

undercabinet cubby applications

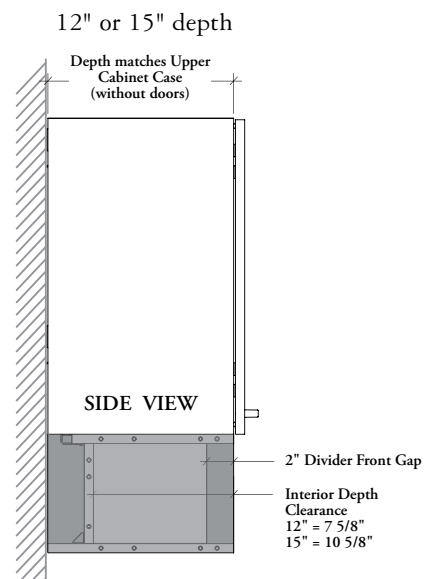
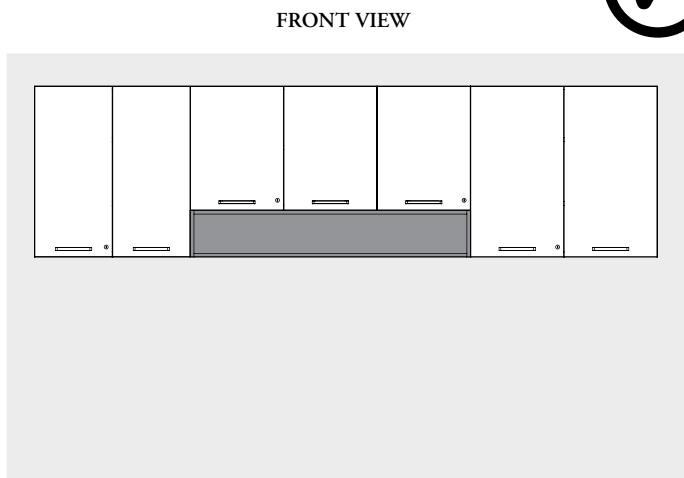

- Depth must be specified to match the Upper Cabinet under which it will be installed

- Width must be specified to align with end of cabinets of between two door fronts

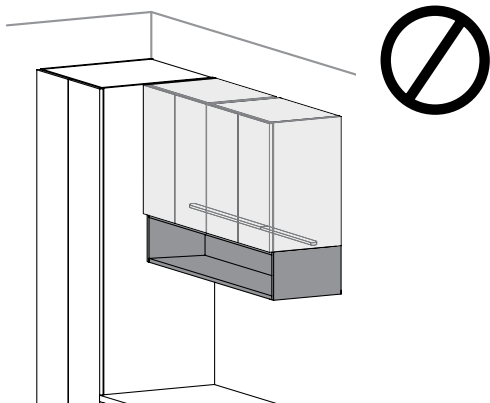

- The Upper Cabinets on which the Undercabinet Cubby will be mounted **cannot** be specified with Light Management (groove connection)

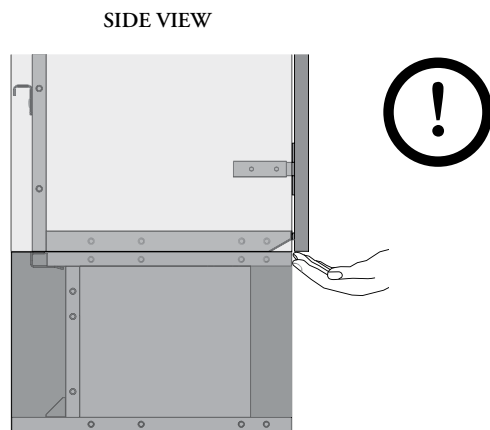

- It is **not** recommended to use this cubby under Upper Cabinet with Finger Pull (X) option because Undercabinet Cubby will obstruct the door opening access when specified with this pull style

planning with accessories (continued)

planning with wall-mounted cubby (CEAWC)

- The top must be installed higher than 38" from floor
- Appropriate attachment methods and hardware for a secure and safe installation must be determined by the installer and meet the applicable local building code and laws; additional wall reinforcement is **not** required
- Installer must provide wall mounting fasteners

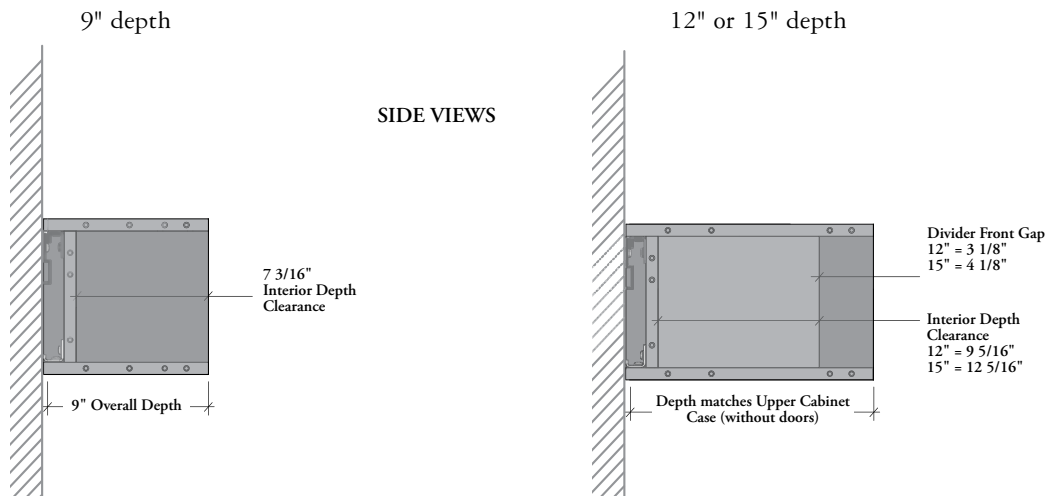

wall-mounted cubby applications



FRONT VIEWS

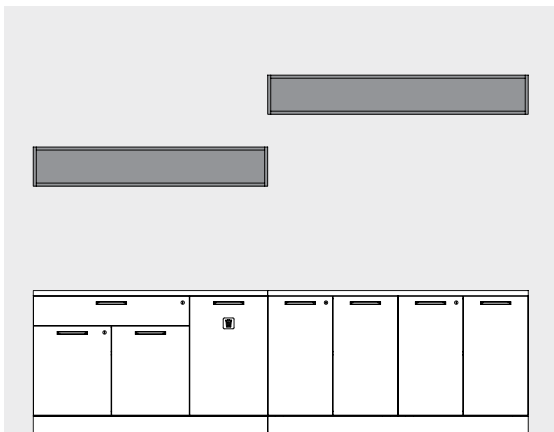

- Can be used alone

OR

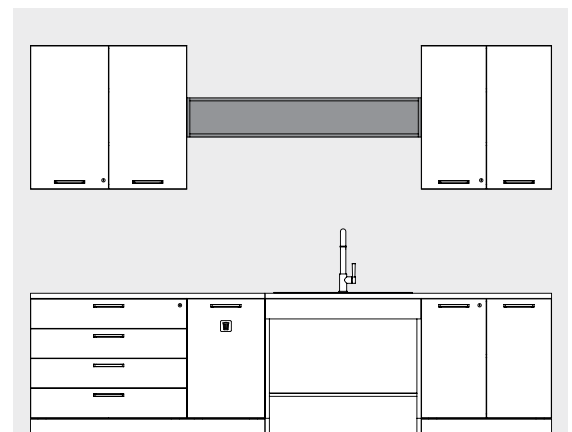

- Can be used between cabinets

planning with accessories (continued)

planning with wall-mounted shelf (CEAWS)

- Two Edge Details are available:

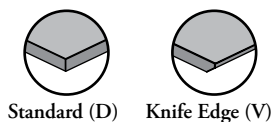

- When Knife Edge (V) Edge Detail is specified, only the front edge will be Full Knife Trim (F)
- Must be installed higher than 38" from floor
- Must be secured to at least two wood or metal studs, or on reinforced wall. Installer must provide wall mounting fasteners
- Appropriate attachment methods and hardware for a secure and safe installation must be determined by the installer and meet the applicable local building code and laws
- All hardware is hidden by a magnetic metal cover

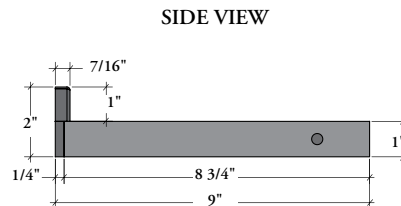

Connecting Shelves with Standard Edge (D)

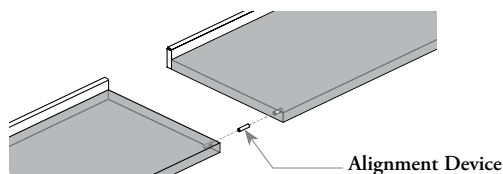

Connecting Shelves with Knife Edge (V)

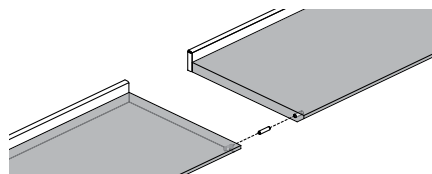

- Alignment device allows to connect shelves together
- It is recommended to specify alignment holes when multiple shelves are installed in a row to ensure proper alignment
- Four Alignment Holes Options are available:
 - Alignment Holes – Both Sides (B)
 - Alignment Holes – Left (L) (Shown)
 - Alignment Holes – Right (R)
 - No Alignment Holes (N)
- Alignment devices are included when Alignment Holes are specified. They are **not** visible once the installation is complete

wall-mounted shelf applications

FRONT VIEW

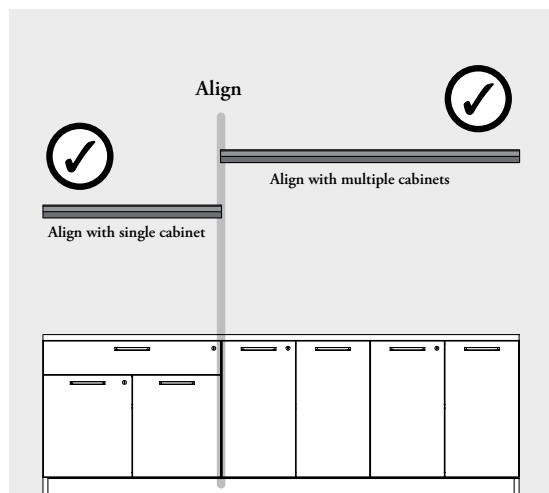

Shelves can align with a single or multiple cabinets

planning with accessories (continued)

planning with wall shelving unit – metal frame & – shelf

Wall Shelving Unit – Metal Frame (CEASF)

- Cannot be used alone, must be specified with Wall Shelving Unit – Shelf (CEASS) to ensure a proper installation
- Top of frame must be installed higher than 38" from floor
- Can be mounted to wood or metal studs, a reinforced wall or be installed with dry wall anchor (toggle); installer must provide wall mounting fasteners
- Appropriate attachment methods and hardware for a secure and safe installation must be determined by the installer and meet the applicable local building code and laws; additional wall reinforcement is **not** required

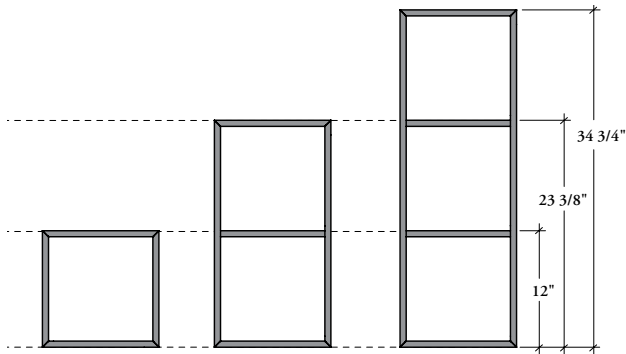

- Heights:
 - One-High Frame Configuration = 12"
 - Two-High Frame Configuration = 23 3/8"
 - Three-High Frame Configuration = 34 3/4"

Wall Shelving Unit – Shelf (CEASS)

- Cannot be used alone, must be used in combination with Wall Shelving Unit – Metal Frame (CEASF)

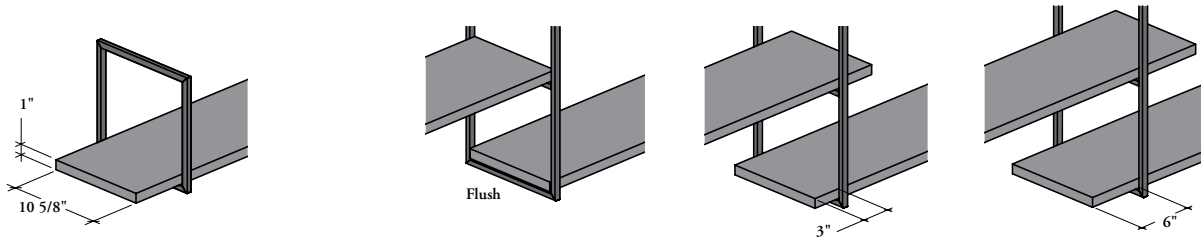

- Shelf can be mounted flush to the frame or exceed up to 6"

wall shelving unit applications

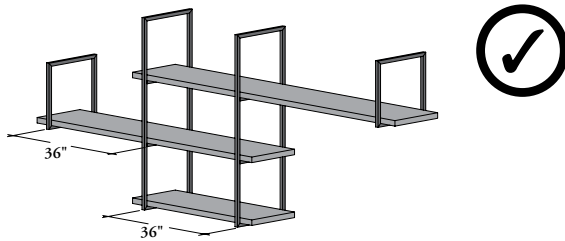

A Shelving Unit – Metal Frame must be installed every 36" (maximum span)

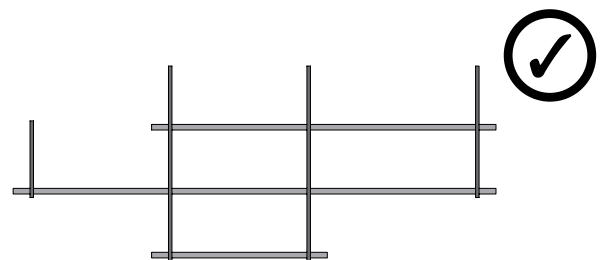

Frame can be combined in various ways to create unique and creative layouts

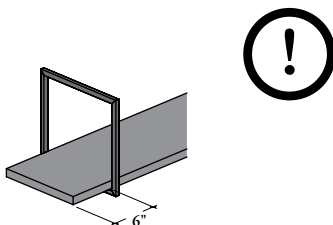

6" is the maximum overhang between the end of the shelf and the frame

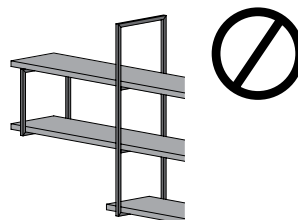

No shelf can be mounted on the top of a frame

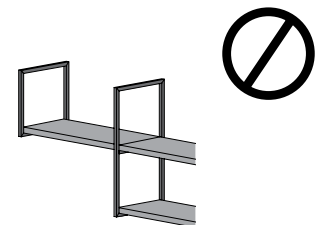

Two shelves **cannot** overlap the same section of frame

planning with accessories (continued)

planning with drawer organizers

Drawer Organizer – Cutlery Tray (CEAOT)

- Made of recyclable plastic
- Compatible with all base cabinets with drawers except Base Cabinet – Filing Drawers (CEBDLF)
- Can also be used with Tall Cabinets with Interior Drawers (CETD and CEMD)
- Can be used in both drawer style. Depending on the drawer style, the tray will be oriented differently

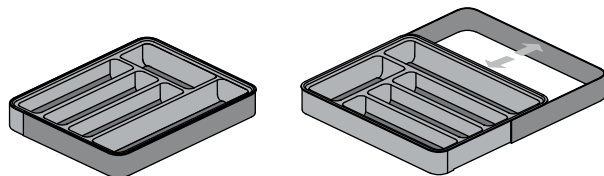

16" deep Standard – Soft Close (S) drawers

20" deep Undermount – Soft Close (U) drawers, it needs to be positioned on the other side and extended from 12" to 19"

Drawer Organizer – Utility Tray (CEAOB)

- Box and Divider are made of metal. The divider is held in place by magnet (easily reconfigurable)
- Compatible with all base cabinets with drawers except Base Cabinet – Filing Drawers (CEBDLF) and all Tall Cabinets with Interior Drawers (CETD and CEMD)
- The reconfigurable divider can be installed in 3 different positions
- Two depths are available to match both Drawer Styles:

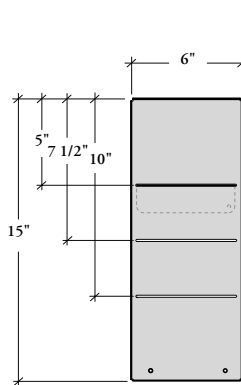

16" deep Standard – Soft Close (16)

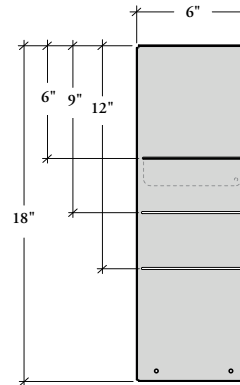

20" deep Undermount – Soft Close (20)

drawer organizer combinations

Depending on the drawer style and width, several Drawer Organizers can be combined together, here are some examples:

Standard – Soft Close Drawer Style (16" depth)

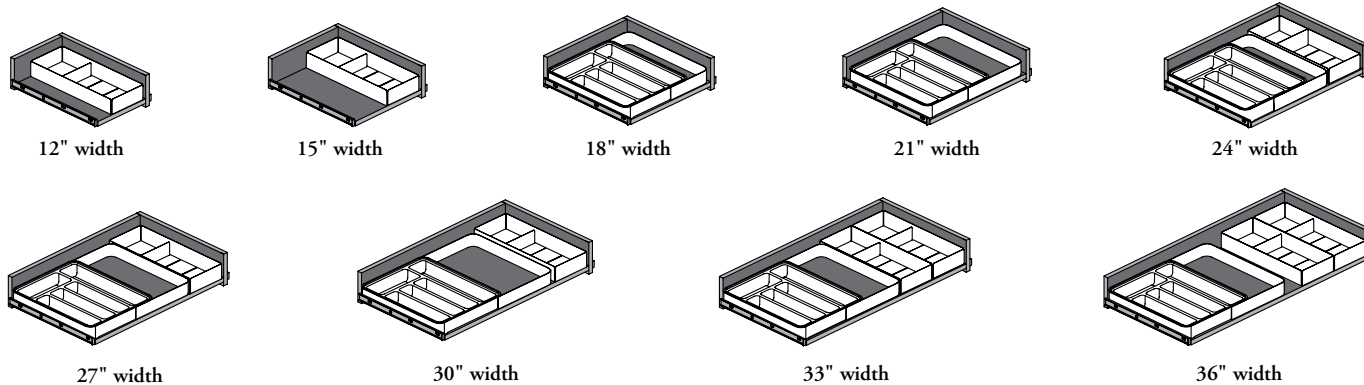

Undermount – Soft Close Drawer Style (20" depth)

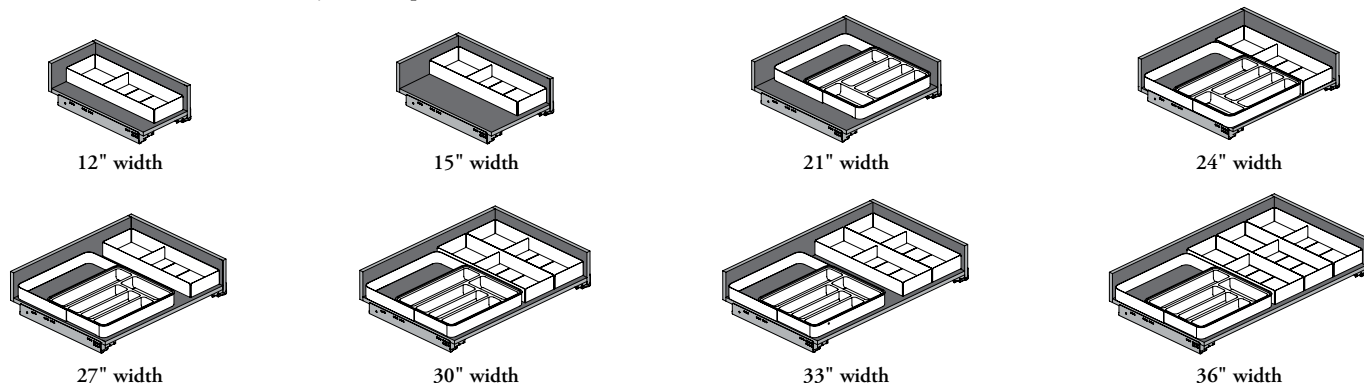

planning with accessories (continued)

planning with symbol identifications

- Recycling/Disposal Symbols (CEASR) are always positioned at the center top of door
- Each center/unit compartment can be identified by a Recycling/Disposal Symbol
- Door fronts come with pre-drill holes when Symbol Ready (S) is specified
- None (N) or With Back Plate configuration (W) can also be specified
- Can be specified with:
 - Base Cabinet– Pull-Out Recycling/Disposal Center (CEBWPD or CEBWPX)
 - Base Cabinet– Recycling/Disposal Center (CEBWU)
 - Storage Cabinet– Recycling/Disposal Units (CESRUS or CESRUX)
- Eight symbols are available:

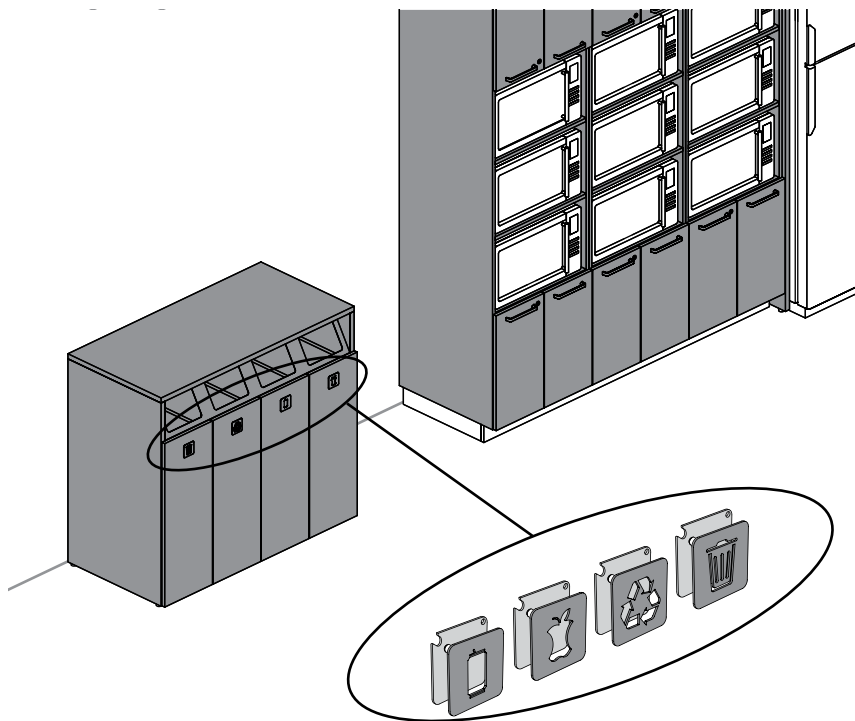
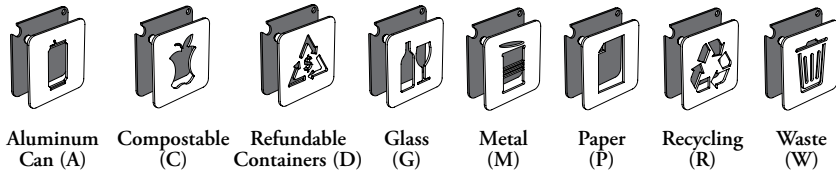

reconfigurable

Symbols Metal Plate are mechanically installed on door and can easily be reconfigured without tools

Symbol Plate with Welded Threaded Studs

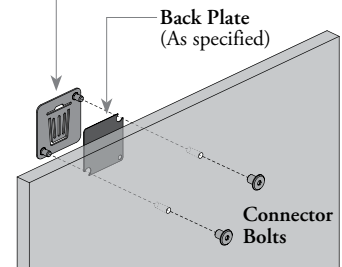

front & back plate applications

Two ways to specify the Recycling/Disposal Symbol



Highlighted Plate

- The plate can be highlighted on the door to create a stronger visual statement, using or **not** a back plate to create an accent on the symbol
- To create a see-through look with metal, the back plate must be specified with the same color than the door
- With solid doors, symbols can be specified without back plate to create a true see-through look







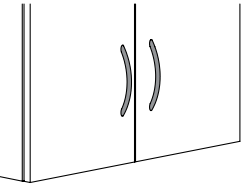
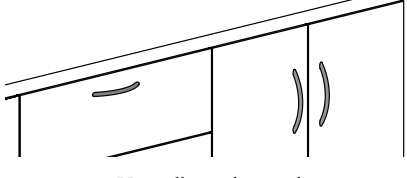
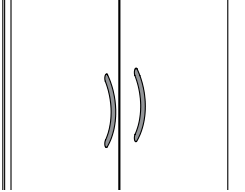

Highlighted Symbols

To create a highlighted symbols the front plate can be specified with the same or similar color than the door, and the back plate can be specified to the desired highlight color

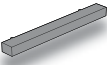
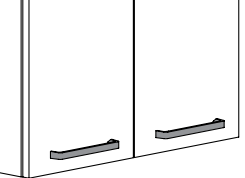
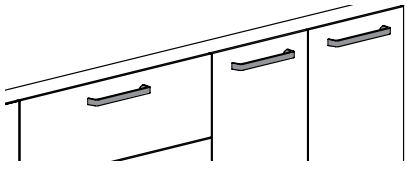
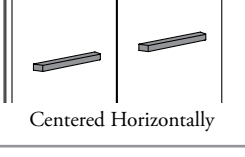
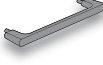
pull styles

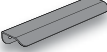
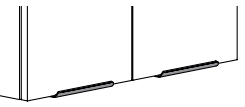
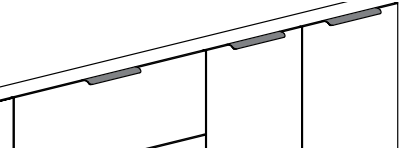
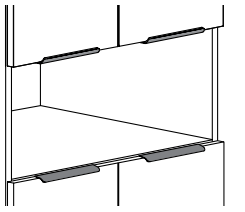
- To meet the ADA standards, it is recommended to use the Stainless (ADA) (8) or Modern Straight (ADA) (M) pull style. The handle height on Base Cabinets, Tall Cabinet – Doors (CETS) and on bottom section of all others Tall Cabinets will match the ADA requirement
- Nines pull styles are available, the following chart illustrates pull orientation depending on the pull and cabinet specified:

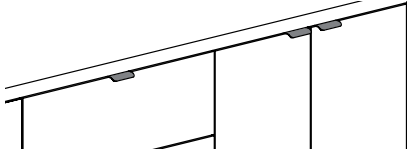
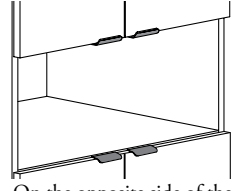
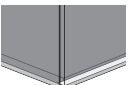
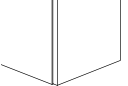
pull styles	upper cabinet (CEUS, CEUMS, CEUPS or CEUCS)	base cabinet (All Base Cabinets, except CEBWU or CEBKRO)	storage cabinet (All Storage Cabinets, except CETO, CÉSRSU or CÉSRSUX)
 Standard Expansion (1)			
 Stainless (ADA) (8)	Vertically	Vertically on door and Horizontally on drawer	Vertically
 Rectangular (9)			
 Modern Straight (ADA) (M)	Centered Horizontally	Centered Horizontally on door and drawer	Centered Horizontally
 Slim (S) (Shown)			Centered Horizontally on doors except CETS, CETT et CETD handles will be vertical
 Edge – Standard (E)			
	Centered horizontally on the bottom edge of the door	Centered horizontally on the top edge of the door and drawer	Centered Horizontally
 Edge – Small (F)			
	On the opposite side of the hinges, bottom edge of the door	On the opposite side of the hinges, centered on the top edge of the drawer*	On the opposite side of the hinges, top edge
 Finger Pull (X)	The Finger Pull option features a detail on the bottom shelf of the Upper Cabinet, enabling door opening without the need for a handle	N/A	The Finger Pull option features a detail on the bottom shelf of the CECM, CEKO or CEKT enabling door opening without the need for a handle CEMS or CEMD
 Drilled On- Site – No Pull (Z)	Available	Available	Available

* On specific configurations, for better aesthetic and functionality, the Edge Pull – Small (E) will be centered on the door, example base cabinet (CEBDS)

pull styles (continued)

hole patterns

- The Standard Expansion, Stainless (ADA) and Rectangular Pull Styles use a 128mm hole pattern
 - The Slim and Modern Straight (ADA) Pull Styles use a 160mm hole pattern
 - The edge pull standard and small have a dedicated hole pattern from the back of the door/drawer front and are **not** interchangeable with other pulls
- Some applications may require a countersinking hole at the back

Interchangeable within the same group:

- Standard Expansion (1),
- Stainless (ADA) (8) and
- Rectangular (9)

OR

- Slim (S) and
- Modern Straight (ADA) (M)

pull clearance

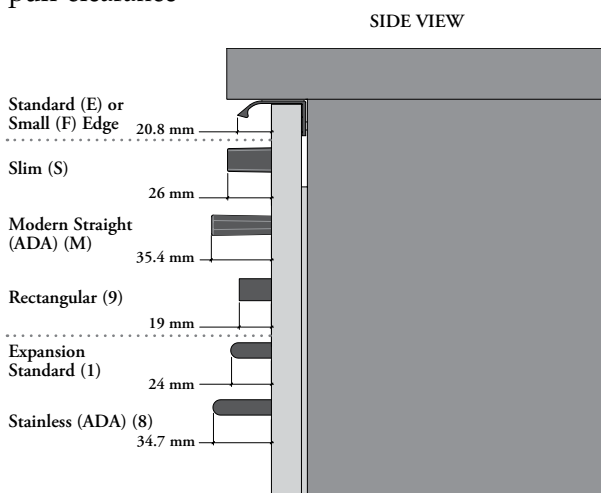

hand clearance

- Expansion Standard = 16 mm
- Stainless (ADA) = 26 mm
- Rectangular = 15 mm
- Slim = 20 mm
- Modern Straight (ADA) = 26 mm

finger pull applications

The Finger Pull (X) option (when available) features a detail on the bottom shelf enabling door opening without the need for a handle. The shelf construction varies depending on whether the case is finished in laminate or flintwood

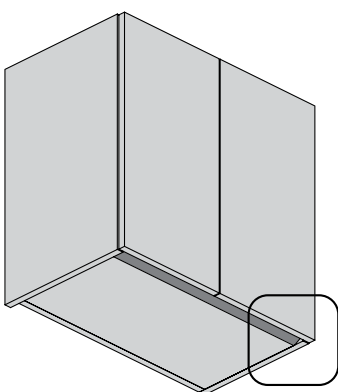

BOTTOM VIEW

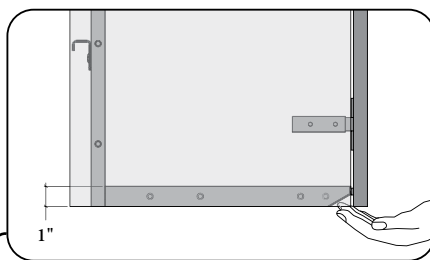

laminate case

The bottom shelf features a knife edge, providing the necessary space to easily grab the door

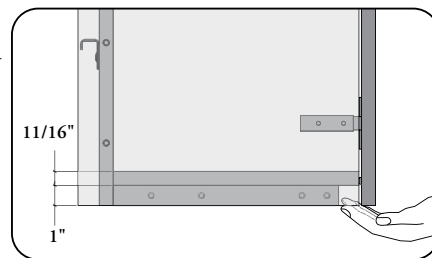

flintwood case

The bottom of the cabinet has a double thickness base leaving the necessary gap to grab the door

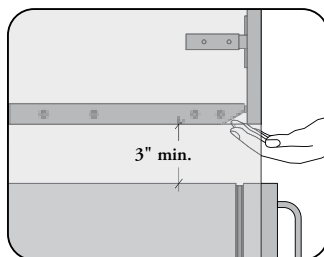

cabinet kits for appliance

When Finger Pull (X) is specified, a minimum 3" gap should be considered between the appliance and the top cabinet to ensure the door can be grabbed easily

lock chart

⚠ If specified, all closed cabinet products come with a lock and key set and can be Keyed Alike (K) or Randomly (R). A Key Chart must accompany every order, otherwise orders will be shipped Keyed Randomly

lock height applications

upper cabinets

For Upper Cabinets, lock height will vary depending on case finish, door finish and pull style

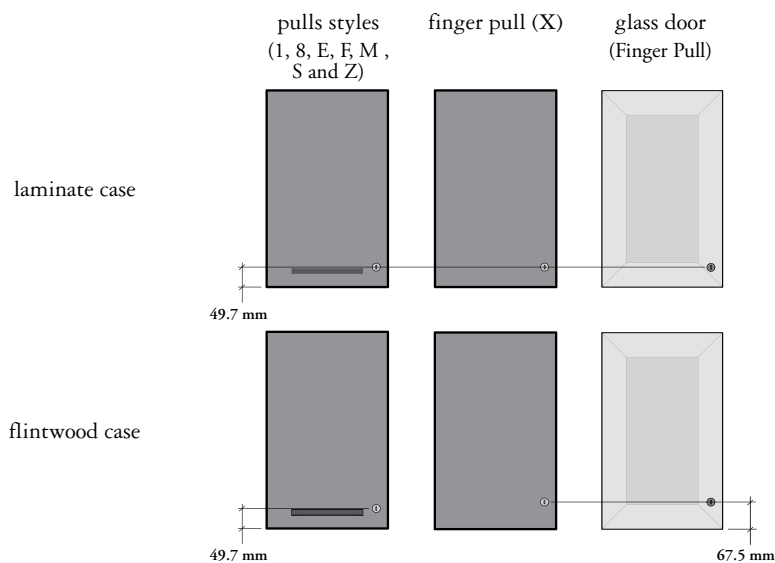

upper cabinets – lock positions

Upper Cabinets – Door(s) (CEUS & CEUG)

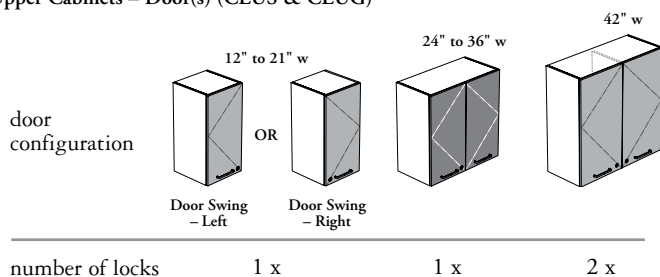

Upper Cabinet – Microwave Section and Doors (CEUMS)

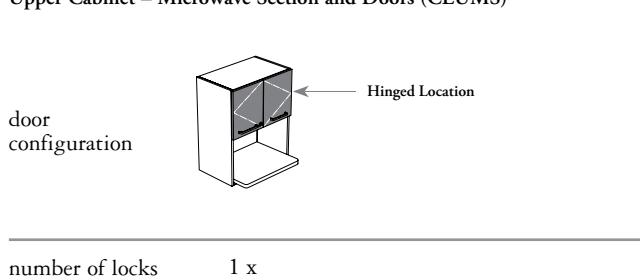

Upper Cabinet – Pigeonholes Section and Door(s) (CEUPS)

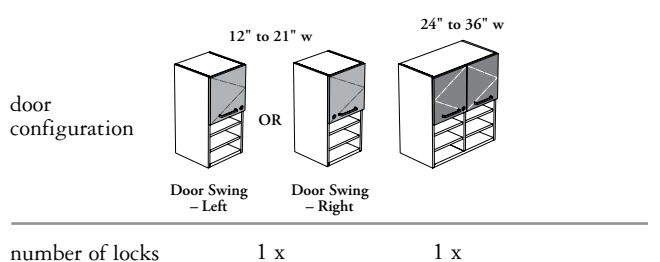

Upper Cabinets for Blind Corner – Doors (CEUCS & CEUCG)

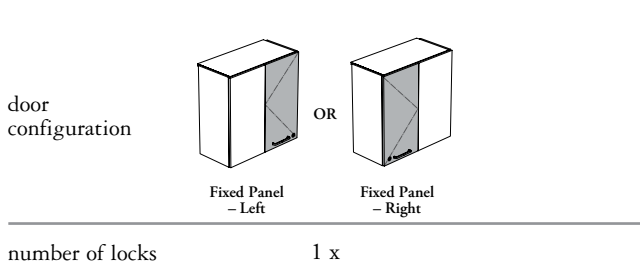

lock chart (continued)

base cabinets – lock positions

Base Cabinets – Door(s) (CEBS)

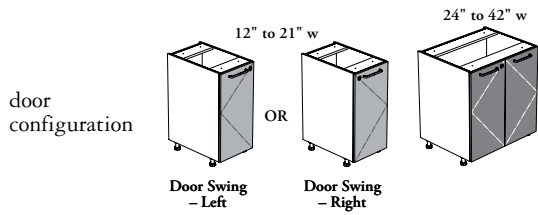

number of locks 1 x 1 x

Base Cabinet – Door(s) and Drawer(s) (CEBDS)

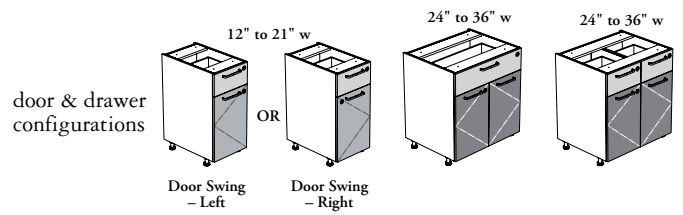

number of locks 1 x 2 x 3 x

Base Cabinet – Three Drawers (CEBDT)

NOTE: Drawers are not lockable when Undermount – Soft Close (U) Drawer Style is specified

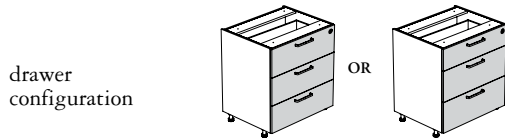

number of locks 1 x 1 x

Base Cabinet – Four Drawers (CEBDF)

NOTE: Drawers are not lockable when Undermount – Soft Close (U) Drawer Style is specified

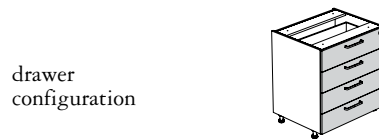

number of locks 1 x

Base Cabinet – Filing Drawer (CEBDLF)



number of locks 1 x

Base Cabinet – Microwave Section and Drawer (CEBMD)

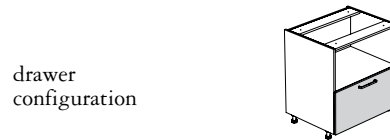

number of locks 1 x

Base Cabinet for Standard Corner – Door (CEBCAS)

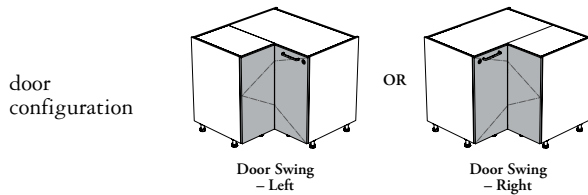

number of locks 1 x

Base Cabinet for Blind Corner – Door (CEBCBS)

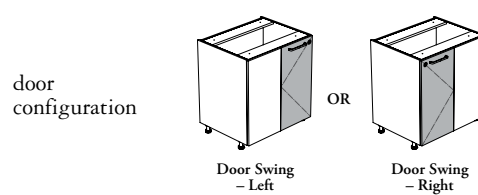

number of locks 1 x

Base Cabinet for Sink – Doors (CEBKs)

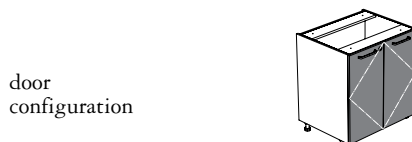

number of locks 1 x

Base Cabinet for Sink – Doors and Flase Front (CEBKFS)

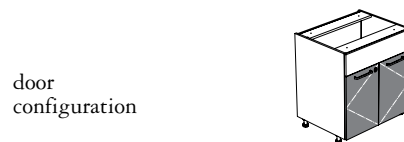

number of locks 1 x

Lockable Double Doors
 Lockable Single Door
 Lockable Drawer(s)
 Not Lockable

lock chart (continued)

storage cabinets – lock positions (continued)

Tall Cabinet – Door(s) (CETS)

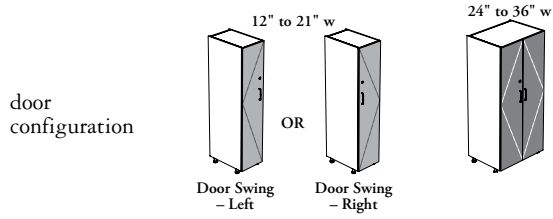

number of locks 1 x 1 x

Two-High Tall Cabinet – Doors (CETT) or Two-High Tall Cabinet – Doors with Interior Drawers (CETD)

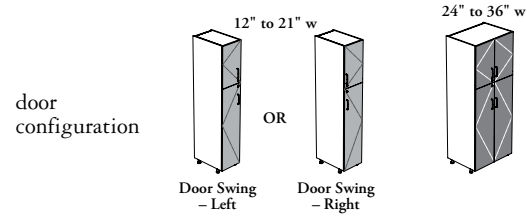

number of locks 2 x 2 x

Tall Cabinet – Microwave Section(s) and Doors (CEMS) or Tall Cabinet – Microwave Section and Doors with Interior Drawers (CEMD)

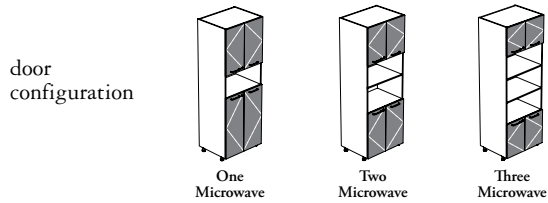

number of locks 2 x 2 x 2 x

Countertop Cabinet – Microwave Section(s) and Doors (CECM)

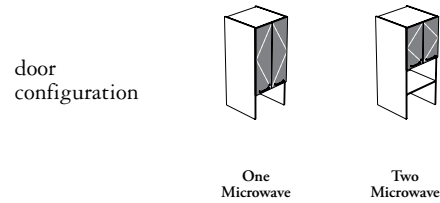

number of locks 1 x 1 x

Cabinet Kit for One Appliance – Doors (CEKO)

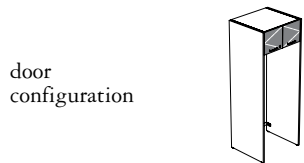

number of locks 1 x

Cabinet Kit for Two Appliances – Doors (CEKT)

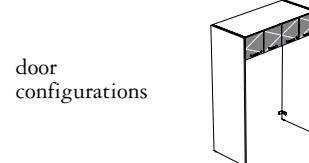

number of locks 2 x

Lockable Double Doors
 Lockable Single Door
 Not Lockable

cabinets product offering

The following illustrates Expansion Casework+ cabinet and open section widths.

⚠ All dimensions shown are actual

upper cabinets

Upper Cabinet – Open (CEUO)

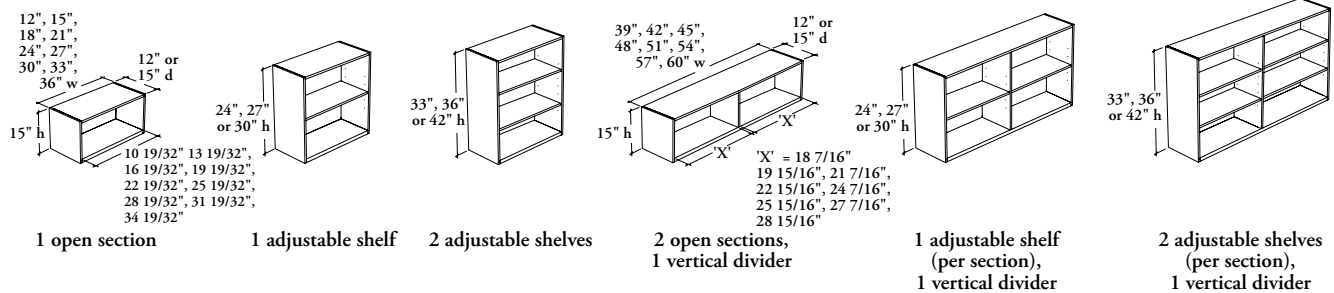

Upper Cabinet – Door(s) (CEUS) & Upper Cabinet – Glass Door(s) (CEUG)

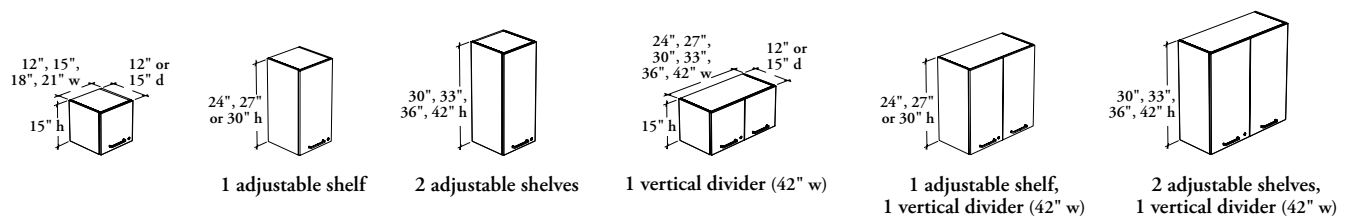

Upper Cabinet – Microwave Section and Doors (CEUMS)

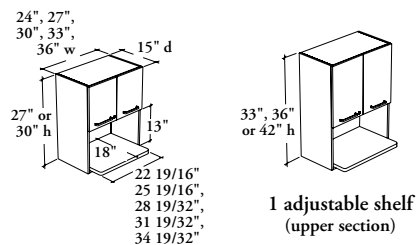

Upper Cabinet – Pigeonholes (CEUPL)

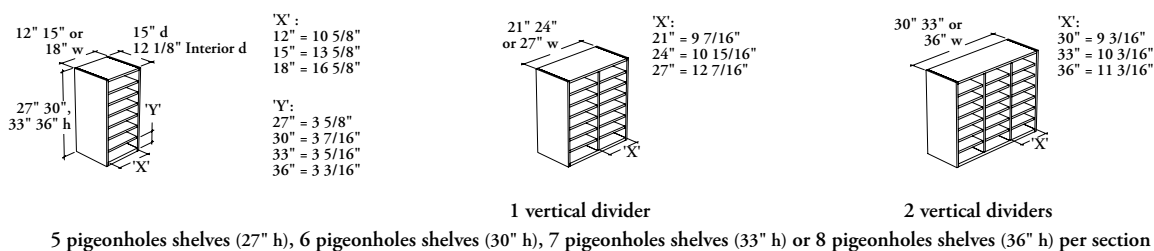

cabinets product offering (continued)

! All dimensions shown are actual

upper cabinets (continued)

Upper Cabinet – Pigeonholes Section and Open (CEUPO)

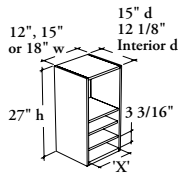

1 open section,
2 pigeonholes
shelves (per section)

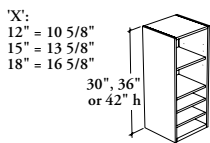

1 adjustable shelf,
2 pigeonholes
shelves (per section)

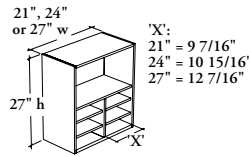

1 open section,
1 vertical divider
2 pigeonholes
shelves (per section)

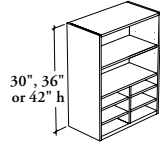

1 adjustable shelf,
1 vertical divider
2 pigeonholes
shelves (per section)

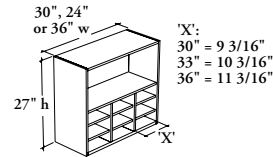

1 open section,
2 dividers
2 pigeonholes
shelves (per section)

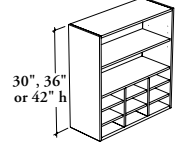

1 adjustable shelf,
2 vertical dividers,
2 pigeonholes
shelves (per section)

Upper Cabinet – Pigeonholes Section and Door(s) (CEUPS)

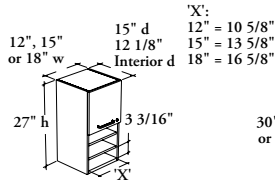

2 pigeonholes
shelves (per section)

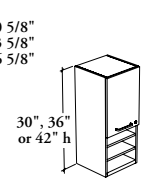

1 adjustable shelf,
2 pigeonholes
shelves (per section)

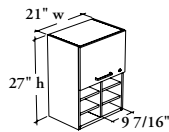

1 adjustable shelf,
1 vertical divider
2 pigeonholes
shelves (per section)

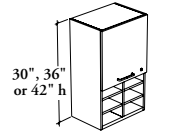

1 vertical divider
2 pigeonholes
shelves (per section)

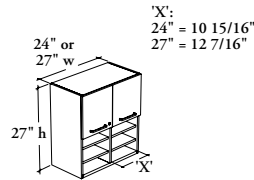

1 vertical divider
2 pigeonholes
shelves (per section)

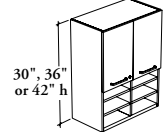

1 adjustable shelf,
1 vertical divider
2 pigeonholes
shelves (per section)

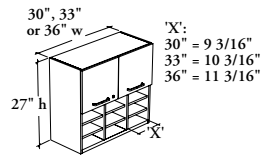

2 vertical dividers
2 pigeonholes
shelves (per section)

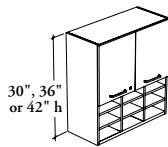

1 adjustable shelf,
2 vertical dividers,
2 pigeonholes
shelves (per section)

Upper Cabinet for Blind Corner – Door (CEUCS) & Upper Cabinet for Blind Corner – Glass Door (CEUCG)

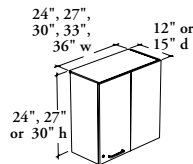

1 adjustable shelf

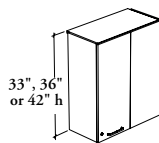

2 adjustable shelves

cabinets product offering (continued)

⚠ All dimensions shown are actual

base cabinets

Base Cabinet – Open (CEBO)

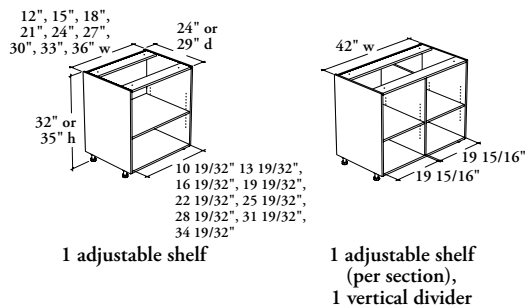

Base Cabinet – Door(s) (CEBS)

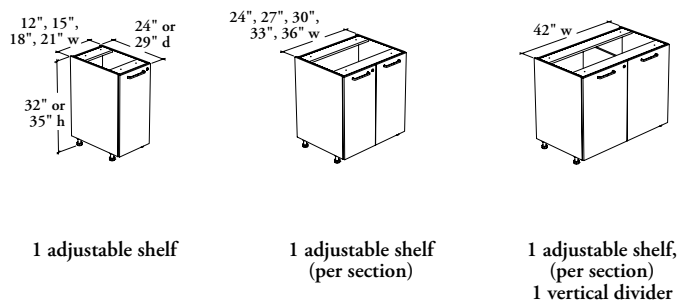

Base Cabinet – Door(s) and Drawer(s) (CEBDS)

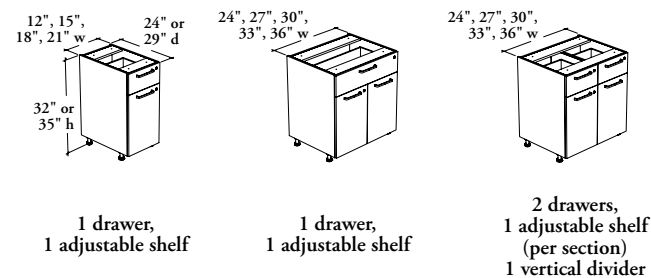

Base Cabinet – Three Drawers (CEBDT)

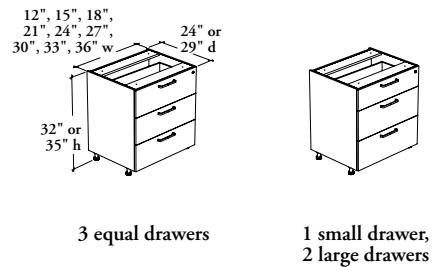

Base Cabinet – Four Drawers (CEBDF)

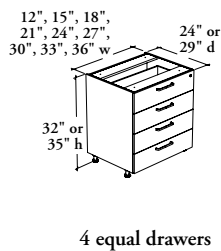

Base Cabinet – Filing Drawers (CEBDFL)

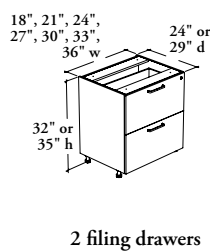

Base Cabinet – Microwave Section and Drawer (CEBMD)

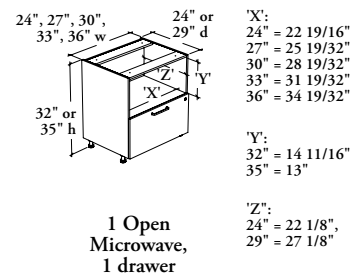

Base Cabinet – Pull-Out Recycling/Disposal Center – Dual Bins (CEBWPD)

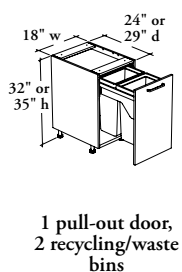

Base Base Cabinet – Pull-Out Recycling/Disposal Center – XL Single Bin (CEBWPX)

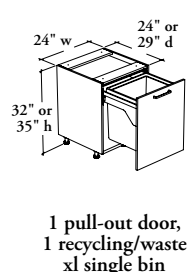

cabinets product offering (continued)

! All dimensions shown are actual

base cabinets (continued)

Base Cabinet – Open Recycling/Disposal Center (CEBWU)

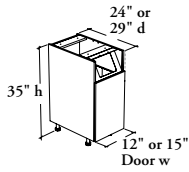

1 open recycling/
disposal section,
1 recycling/waste
bin

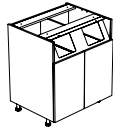

2 open recycling/
disposal sections,
1 recycling/waste
bin (per section)

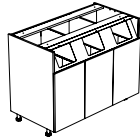

3 open recycling/
disposal sections,
1 recycling/waste
bin (per section)

Base Cabinet for Standard Corner – Door (CEBCAS)

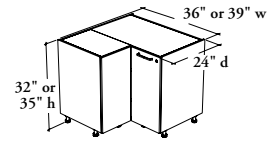

2 adjustable
shelves

Base Cabinet for Blind Corner – Door (CEBCBS)

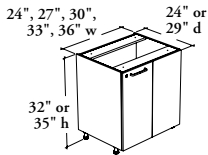

1 door,
1 fixed panel,
1 adjustable shelf

Base Cabinet for Sink – Doors (CEBKBS)

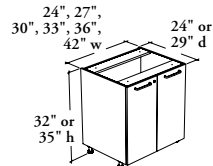

2 doors

Base Cabinet for Sink – Doors and False Front (CEBKFS)

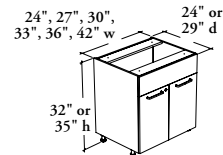

2 doors,
1 false front

Base Cabinet for Sink – People with Reduced Mobility – Doors (CEBKRS)

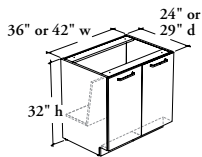

2 doors

Base Cabinet for Sink – People with Reduced Mobility – Open (CEBKRO)

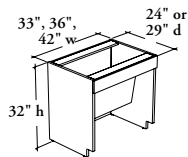

cabinets product offering (continued)



- All dimensions shown are actual
- For more details on interior clearance between shelves or microwave/appliance section(s), refer to page 62

storage cabinets

Tall Cabinet – Open (CETO)

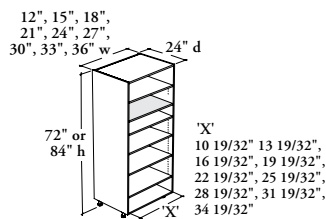

5 adjustable shelves,
1 fixed shelf

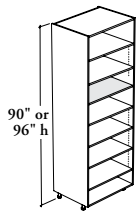

6 adjustable shelves,
1 fixed shelf

Tall Cabinet – Door(s) (CETS)

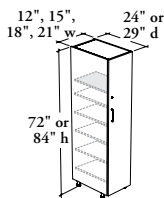

5 adjustable shelves,
1 fixed shelf

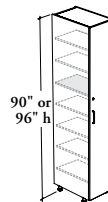

6 adjustable shelves,
1 fixed shelf

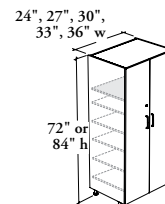

5 adjustable shelves,
1 fixed shelf

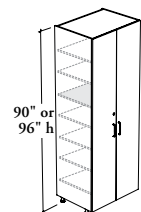

6 adjustable shelves,
1 fixed shelf

Two-High Tall Cabinet – Doors (CETT)

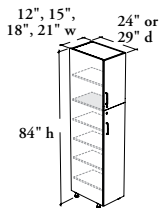

5 adjustable shelves,
1 fixed shelf

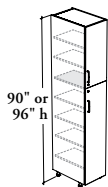

6 adjustable shelves,
1 fixed shelf

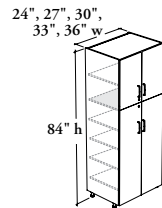

5 adjustable shelves,
1 fixed shelf

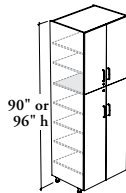

6 adjustable shelves,
1 fixed shelf

Two-High Tall Cabinet – Doors with Interior Drawers (CETD)

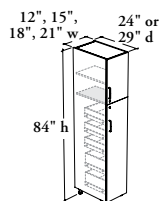

1 adjustable shelf,
1 fixed shelf,
4 interior drawers

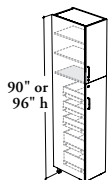

2 adjustable shelves,
1 fixed shelf,
4 interior drawers

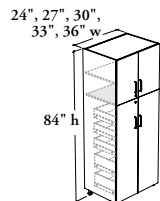

1 adjustable shelf,
1 fixed shelf,
4 interior drawers

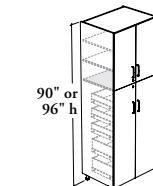

2 adjustable shelves,
1 fixed shelf,
4 interior drawers

Tall Cabinet – Microwave Section(s) and Doors (CEMS)

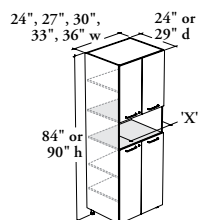

1 open microwave,
3 adjustable shelves

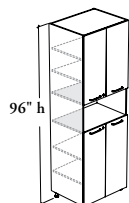

1 open microwave,
4 adjustable shelves

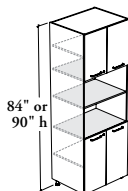

2 opens microwave,
2 adjustable shelves

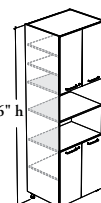

2 opens microwave,
3 adjustable shelves

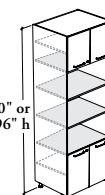

3 opens microwave,
2 adjustable shelves

cabinets product offering (continued)

- All dimensions shown are actual
- For more details on interior clearance between shelves or microwave/appliance section(s), refer to page 62

storage cabinets (continued)

Countertop Cabinet – Microwave Section(s) and Doors (CECM)

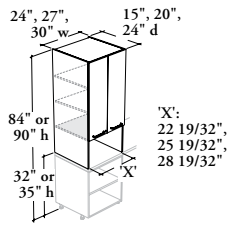

1 open microwave,
2 adjustable shelves

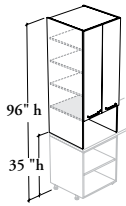

1 open microwave,
3 adjustable shelves

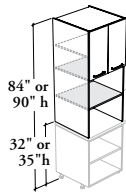

2 opens microwave,
1 adjustable shelf

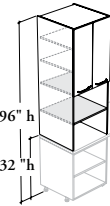

2 opens microwave,
2 adjustable shelves

Cabinet Kit for One Appliance – Doors (CEKO)

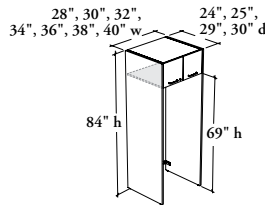

2 doors

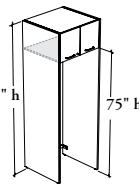

2 doors

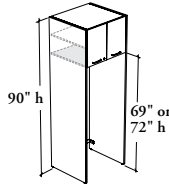

2 doors,
1 adjustable shelf

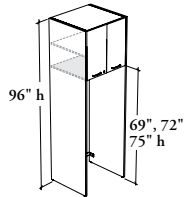

2 doors
1 adjustable shelf

Cabinet Kit for Two Appliances – Doors (CEKT)

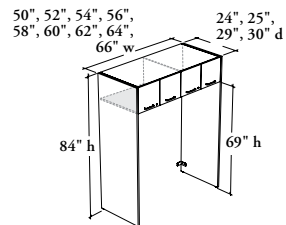

4 doors

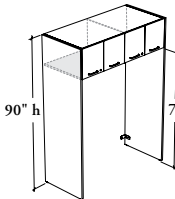

4 doors

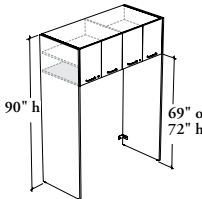

4 doors,
1 adjustable shelf
(per section)

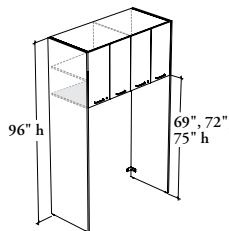

4 doors,
1 adjustable shelf
(per section)

Recycling/Disposal Unit – Standard Bins (CESRUS)

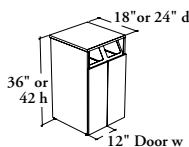

2 open recycling/
disposal sections,
2 standard bins
(per section)

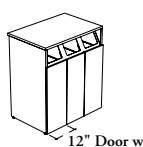

3 open recycling/
disposal sections,
3 standard bins
(per section)

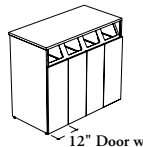

4 open recycling/
disposal sections,
4 standard bins
(per section)

Recycling/Disposal Unit – XL Bins (CESRUX)

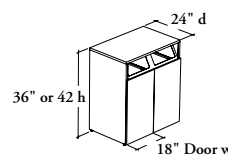

2 open recycling/
disposal sections,
2 XL bins
(per section)

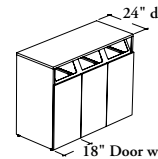

3 open recycling/
disposal sections,
3 XL standard bins
(per section)

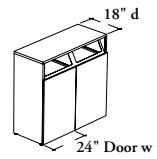

2 open recycling/
disposal sections,
2 XL bins
(per section)

grain direction

- Woodgrain pattern on the Countertop and Island Countertop run parallel to length of the worksurface
- Door grain direction will always be vertical
- Drawer front grain direction will vary depending on product and finish selected
- The grain direction will be as illustrated below, whether the grain is cathedral, straight, Source Laminate or Flintwood. But only cathedral wood grains will be bookmatched

laminate

Source Laminate

- 3F – 3K – XJ

Foundation Laminate

- 2F – 2K – JG

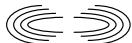
Laminate =  = Grain Direction = 

For colors listed above, the **Straight Grain Pattern** for door and drawer fronts will be vertical

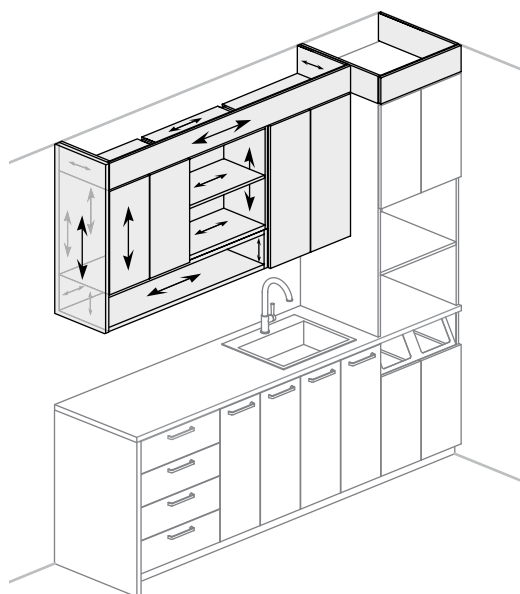

Upper Cabinets, Top Filler, End Panel & Undercabinet (Shown) or Wall-Mounted Cubby

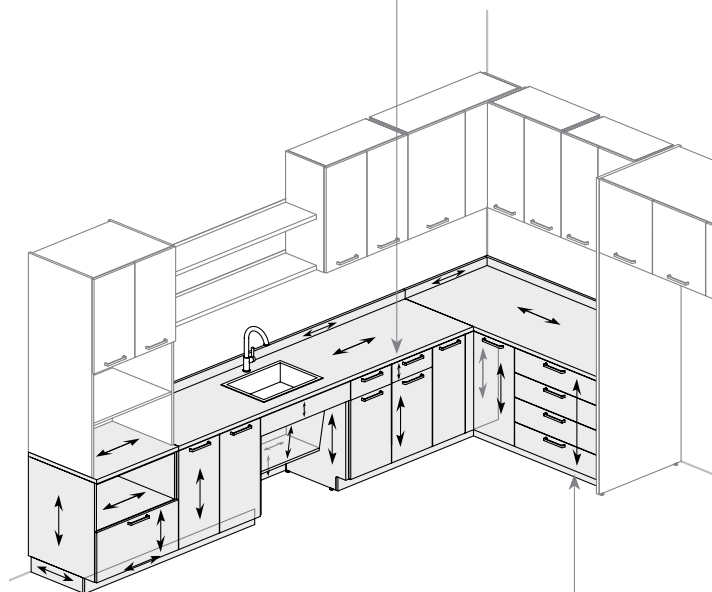

Base Cabinets, Countertop, Backsplash & Sidesplash

Source Laminate

- 3A – 3D – 3E – 3L – 3M – 3X – 8E – 8R – 8S – XR – 86 – 87 – 88

Foundation Laminate

- 2A – 2D – 2E – 2L – 2M – 2X – 7B – 7M – 7S – 7U – 7V – 7Z – YR

For colors listed above, the **Cathedral Grain Pattern** for door and drawer fronts will be book-matched

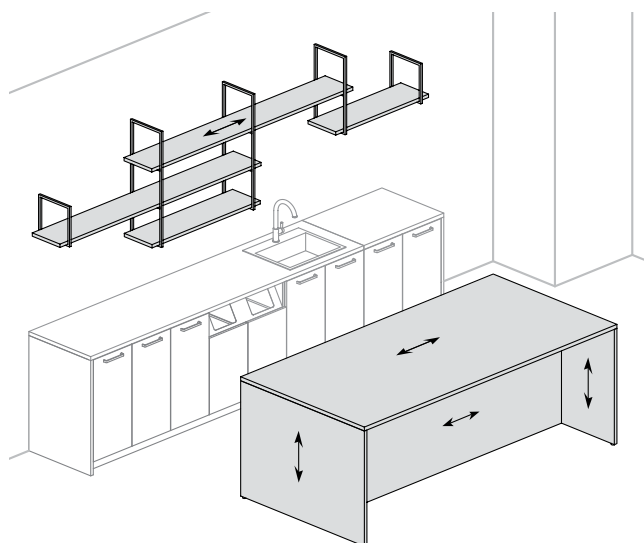

Wall-Shelving Unit – Shelves (Shown), Undercabinet Accessory Shelf or Wall-Mounted Shelf, Island Countertop & Island Structure with Gables

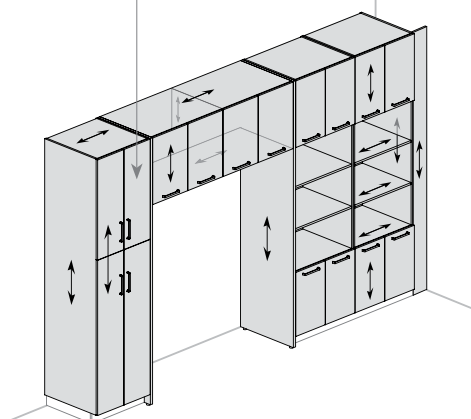

Storage Cabinets & Side Filler

grain direction (continued)

flintwood

Flintwood has a rift cut grain pattern



Straight Grain Pattern:

Flintwood

- FC – FD – FM – FN – FX – NR – NT – VA – VB – VZ – 5N – 5P – 5Q – 5R – 5S – 5T – 5V – 5W – 5Z

For colors listed above, the Straight Grain Pattern for door and drawer fronts will be vertical

NOTE: When Flintwood fronts are specified on Source Laminate case, fronts will not be bookmatched

Flintwood =  = Grain Direction = 

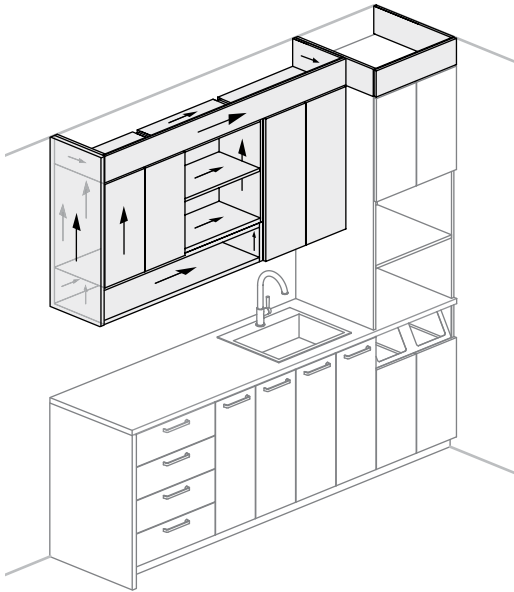

Upper Cabinets, Top Filler, End Panel & Undercabinet (Shown) or Wall-Mounted Cubby

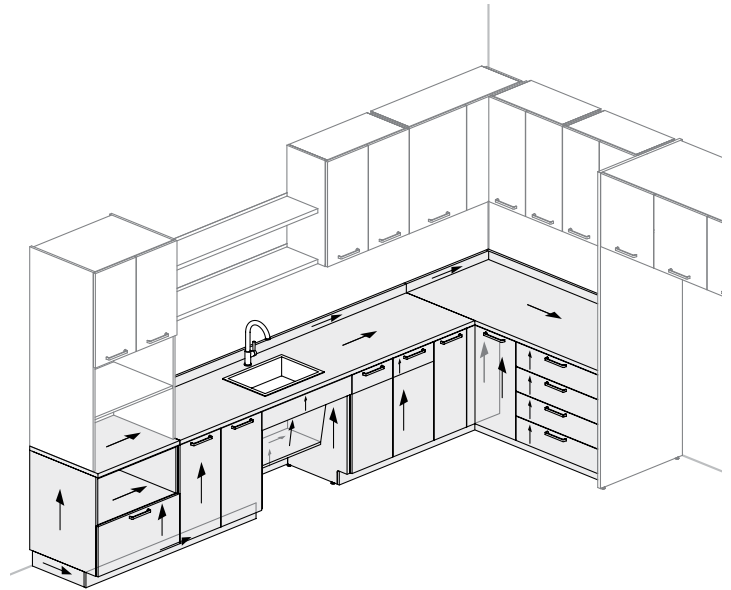

Base Cabinets, Countertop, Backsplash & Sidesplash

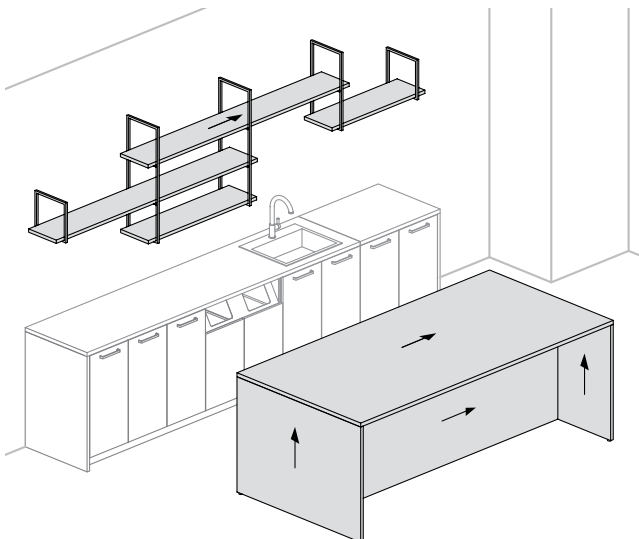

Wall-Shelving Unit – Shelves (Shown), Undercabinet Accessory Shelf or Wall-Mounted Shelf, Island Countertop & Island Structure with Gables

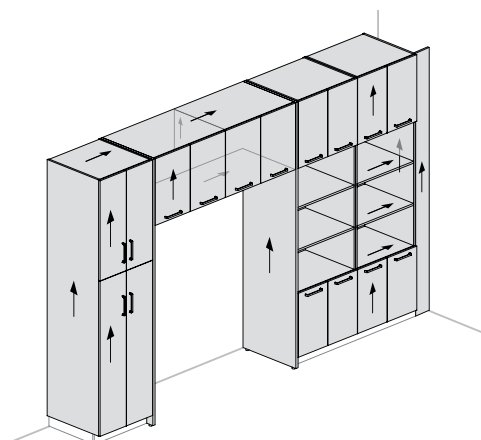

Storage Cabinets & Side Filler

edge trim style overview

The chart below indicates which edge trim styles can be specified with countertop and shelf finishes.

❗ The Flintwood Flat Trim (9) always match surface color finish

edge trim chart

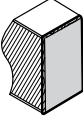
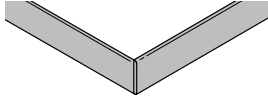
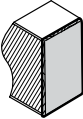
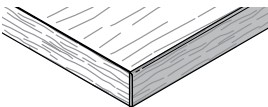
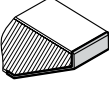
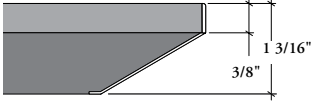
edge on product	description	source laminate, foundation laminate or grade 2 laminate worksurface finish	flintwood worksurface finish	Applicable with products...
 <p>Flat Trim (8)</p>	<p>Straight Corner Style</p>  <p>1.5 mm thick on all edges</p>	Yes	n/a	CEWCT CEWIC CEAWS CEASS
 <p>Flintwood Flat Trim (9)</p>	<p>Straight Corner Style</p>  <p>1.4 mm thick on all edges</p>	n/a	Yes	CEWCT CEWIC CEAWS CEASS
 <p>Full Knife Trim (F) (Only available with Knife Edge (V))</p>	<p>Straight Corner Style</p>  <p>1.5 mm thick on all edges</p>	Yes	n/a	CEAWS