

**Systems**

Effective September 2024 US

# Boulevard

Pricebook + Application Guide



<b>General Information</b>	<b>A</b>	<b>Desking</b>	
Table of Contents			
Lifetime Warranty		<b>Licence</b>	<b>E</b>
Finishes		Product Overview	E.1
<b>Systems</b>		Woodgrain Chart	E.2
<b>Boulevard</b>	<b>B</b>	Grommet Chart	E.3
Product Overview	B.1	Desks	E.6
Value Added Benefits	B.3	Reception Desks	E.14
Woodgrain Chart	B.4	Desks & Return Desks	E.16
Boulevard 1 Technical Information	B.5	Shaped Table Desks	E.33
Boulevard 1 Panels	B.6	Runoff-Shaped Tables	E.42
- Guidelines for Ordering Product		Floating-Shaped Tables	E.43
Boulevard 1 Graphic Panels	B.7	Modesty Panels	E.45
Boulevard 1 Panels	B.9	Storage	E.46
Boulevard 1 Connectors and Trims	B.22	Pantry	E.75
Boulevard System 3 Panel	B.30	Collaboration Tables	E.76
System/Technical Information		Conference Tables	E.78
Boulevard System 3 Panels	B.31	Conference Table Bases	E.94
-Guidelines for Ordering Product		Visual Board	E.98
Boulevard System 3 Graphic Panels	B.32	Conference Table Modules	E.99
Boulevard System 3 Panels	B.33	<b>Terina Tables</b>	<b>F</b>
Boulevard System 3 Connectors and Trims	B.52	<b>FreeFit Height-Adjustable Tables</b>	<b>G</b>
Boulevard Gallery Panels	B.56	Product Overview	G.1
Electrical	B.62	Bases	G.6
Worksurfaces	B.71	Tops	G.10
Worksurface Hardware	B.81	Power/Data	G.14
Storage	B.85	Dividers	G.17
<b>Diet</b>	<b>C</b>	Accessories	G.22
Diet Panel System/Technical Information	C.1	<b>Wellness Solutions</b>	<b>H</b>
Panels	C.2	Screens	H.1
Panel Connectors	C.9	Booth	H.2
Electrical	C.15		
Linking Panels	C.16		
Linking Panel Connectors	C.18		
Worksurfaces and Hardware	C.19		
Storage	C.20		
<b>Accessories</b>	<b>D</b>		
Keyboard Trays and Mechanisms	D.1		
Computer Support	D.4		
Monitor Arms	D.4		
Lights	D.8		
Grommets/Power Modules/Bars	D.9		
Paper Management	D.11		

## PANEL FINISHES

Panel Frame/Raceway/Hardware	Acrylic Glazing	Tempered Glass
Black	Clear	Clear
Blizzard	Frosted	Frosted
Charcoal		
Designer White		
Nevada		
Silver		
Stonedust		
Taupe		
Tungsten		

## STORAGE AND WORKSURFACE FINISHES

Metal Storage Colors - Panel Frame Matches	PVC Edge Finishes - Panel Frame Matches	Worksurface PVC Edge Trim - Wood Grain Matches
Black	Black	Absolute Acajou
Blizzard	Blizzard	Asian Night
Charcoal	Brushed Cobalt	Avant Cherry
Designer White	Charcoal	Avant Honey
Nevada	Designer White	Clear Maple
Silver	Nevada	Dark Espresso
Stonedust	Silver	Fashionista
Taupe	Stonedust	First Class
Tungsten	Taupe	Noce Biondo
	Tungsten	Noce Grigio

Low Pressure Laminates (LP) Panel Frame Matches	Low Pressure Laminates (LP) Solids and Patterns	Low Pressure Laminates (LP) Wood Grain Laminates
Black	Blizzard Matrix	Absolute Acajou
Blizzard	Grey Matrix	Asian Night
Brushed Cobalt (Tungsten)	Hayden Linen	Avant Cherry
Custom Grey (Silver)	Stone Linen	Avant Honey
Designer White	Studio White Matrix	Clear Maple
Hayden Grey (Taupe)		Dark Espresso
Stonedust		Fashionista
Storm Grey (Charcoal)		First Class
String (Nevada)		Noce Biondo
		Noce Grigio

High Pressure Laminates (HP) Panel Frame Matches	High Pressure Laminates (HP) Solids and Patterns	High Pressure Laminates (HP) Wood Grain Laminates
Black	Blizzard Matrix	Absolute Acajou
Blizzard	Grey Matrix	Asian Night
Brushed Cobalt (Tungsten)	Hayden Linen	Avant Cherry
Custom Grey (Silver)	Stone Linen	Avant Honey
Designer White	Studio White Matrix	Clear Maple
Hayden Grey (Taupe)		Dark Espresso
Stonedust		Fashionista *
Storm Grey (Charcoal)		First Class *
String (Nevada)		Noce Biondo
		Noce Grigio

\* The maximum length to have wood grain match will be 108" for Fashionista FAS, FirstClass FCL, Sheer Beauty SBY.

**PET FELT COLORS**

Amethyst	AMT
Apricot	APR
Black	BLK
Blue Smoke	BSK
Carnation	CNN
Emerald	EMD
Graphite	GPH
Lapis	LAP
Mist	MTS
Navy	NVY
Pewter	PWT
Ruby	RBV
Sunflower	SFR
White	WHT
Brick	BRI
Denim	DEN
Harvest	HVT
Shamrock	SHR

**PANEL FABRICS GRADE 1**

<b>Anchorage (R)</b>	<b>Linea (R)</b>	<b>Merge (R)</b>	<b>Tek (R)</b>
Birch	AN40	Queue LN41	Fawn MG20
Green Apple	AN41	Cord LN42	Marshmallow MG21
Lapis	AN42	Twine LN43	Driftwood MG22
Straw	AN43	Thread LN44	Dove MG23
Wolf	AN44	Contour LN45	Graphite MG24
Goose	AN45	Silhouette LN46	Slate MG25
Angora	AN46	Cable LN47	Eucalyptus MG26
Cumin	AN47	Route LN48	Fire Engine MG27
Asteroid	AN48		Mediterranean MG28
Geranium	AN49		Midnight MG29
Thistle	AN50	<b>Lisbon (R)</b>	
Graphite	AN51	Gesso LS11	
Slate	AN52	Dusk LS12	<b>Pinpoint (R)</b>
Quarry Blue	AN53	Grey LS13	Bliss PN11
Onyx	AN54	Ivory LS14	Delight PN12
Pumpkin	AN55	Henna LS15	Dune PN13
Red Delicious	AN56	Nocturnal LS16	Infusion PN14
Sunshine	AN57	Moss LS17	Ebony PN15
Vanilla	AN61	Navy LS18	Fresh PN16
Cobalt	AN62	Buff LS19	Carrot PN17
Clouds	AN64	Spa LS20	Splash PN18
			Vibe PN19
			Gala PN20
		<b>Loopy (R)</b>	
<b>Aurora (R)</b>		Oyster LP60	
Cloud	AU20	Putty LP61	<b>Streak (R)</b>
Seal	AU21	Marble LP62	Beach SR81
Fog	AU22	Hazelnut LP63	Shade SR86
Pewter	AU23	Latte LP64	Stretch SR88
Granite	AU24	Bay LP65	Sprint SR89
Oat	AU25	Wild Rice LP66	Roll SR91
Coconut	AU26	Harbor LP67	Dart SR92
Latte	AU27		Zoom SR93
Lake	AU28	<b>Melody (R)</b>	Splash SR94
Frost	AU29	Spray ME40	Whiz SR95
		Pond ME41	Flash SR96
		Sand Bar ME42	
<b>Chance (R)</b>		Silt ME43	
Mist	CN51	Pebble ME44	
Dill	CN52	Lake ME45	
Island	CN53	Gravel ME46	
Plaza	CN54	Boulder ME47	
Tranquil	CN55		
Malt	CN56		
Navajo	CN57		
Prairie	CN58		
Cinder	CN59		
Oasis	CN66		

**Terrace (R)**  
Terrace is 57" wide, it cannot fit on panels wider than 54", it may be railroaded, but will require special application and pricing.

Lotus	TC60
Tigerlily	TC61
Shadow	TC62
Cobble	TC63
Cherry Blossom	TC64
Bluebell	TC65
Apple	TC66
Haze	TC67
Cerise	TC68
Twilight	TC69
Wintergreen	TC70
Ironwork	TC71
Pine Cone	TC72
Flirt	TC73
Echo	TC74
Glacier	TC75

Note:  
(R) = Recycled Fabric

**PANEL FABRICS GRADE 2**

<b>Cyclone</b>		<b>Quadrille (not available on Diet)</b>	<b>(R)</b>
Stove Pipe	IM37	Quadrille is only 54" wide, it cannot	
Stainless	IM40	fit on panels wider than 48", it may	
Polished Pewter	IM41	be railroaded, but will require special	
Welded Steel	IM43	application and pricing.	
Etched Bronze	IM44	Escapade	QU30
Fired Titanium	IM46	Shenanigan	QU31
Chrome	IM49	Revelry	QU32
Dark Annealed	IM50	Spring	QU33
Karat	IM54	Regalia	QU34
Red Metal	IM55	Soiree	QU35
Oxidized Bronze	IM56	Zest	QU36
Bright Ray	IM57	Gambol	QU37
Bismuth Crystal	IM58	Leisure	QU38
Gallium Blue	IM59	Fair	QU39
		Fiesta	QU40
		Carnival	QU41
<b>Dashing (R)</b>		Spree	QU42
Classic Silver	DS21	Opus	QU43
Refined Marble	DS22	Jubilee	QU44
Antique Sage	DS23	Masquerade	QU45
Polished Slate	DS24	Cabaret	QU46
Genteel Beige	DS25		
Bespoke Tan	DS26		
Dapper Grey	DS27		

Note:  
(R) = Recycled Fabric



**BOULEVARD 1 PANELS**

**Features**

- Desk height power and data management
- Patented "Knuckle-Loc," rigid connection, prevents light and sound transmission
- Built-in acoustical/tackable properties
- Sectional multi-accent design options
- Fabric surfaces are able to be replaced on-site
- Frame incorporates 1" centered slots for component adjustability
- Requires no additional top caps, end caps, trim caps, hinges, kick plates or clips
- Simple to specify
- Reduced installation time
- Easy to reconfigure
- High-tech look/stackable grid appearance
- Rigid, no sway, straight panel sight line
- Self levelers reduce assembly time, ensure even height
- Over panels extend to 10 feet to enclose an office in fabric and glazed options
- Patented Raceway cover easily removed
- Raceway panels top and bottom portion semi tackable

**Construction**

- Rigid extruded aluminum, finished frame, self-leveling 2 5/8" thick panel
- 1 1/8" sound absorbent Mineral Wool each side of hardboard septum

**Sizes**

- 8 Heights: 29", 37", 42", 50", 54", 58", 66" 74" and 82"
- 9 Widths: 6", 18" to 60" in 6" increments, 72" wide in selected panel configurations.

**Adjustability**

- 3" glide stem permits 2 1/2" height adjustment
- Slotted at 1" increments
- Over panels, 8", 16", 24", 37" and 42" for enclosed offices (Non-slotted)

**Acoustic Rating**

.80NRC/26STC

**Door**

- 2 door panel widths, glazed/unglazed, lockable, reversible
- 2 sliding door widths, non-lockable

**Flexibility**

- Universal connector

**Panel Finishes**

- 2 grades of fabric, air flow grill, glaze, tempered glass, laminate & COM

**Electrical**

- Desk height 8 wire/4 circuit - 1 dedicated

**Communication**

- Desk height data channel
- Raceway cover easily removed
- Fabric covered raceways available

**SYSTEM 3 PANELS**

**Features**

- Base power and data lay-in
- Desk height power and data feed thru
- Top data lay-in
- Patented "Knuckle-Loc," rigid connection, prevents light and sound transmission
- Removable multi-functional tile design options
- Fabric surfaces are able to be replaced on-site
- Reduced installation time
- Easy to reconfigure
- High-tech look/stackable grid appearance
- Rigid, no sway, straight panel sight line
- Self levelers reduce assembly time, ensure even height
- Over panels extend height to enclose an office in fabric, glazed or laminate options
- Raceway cover easily removed

**Construction**

- Rigid extruded aluminum

**Sizes**

- 5 Heights: 34", 42", 50", 54", 66"
- 8 Widths: 18" to 60"

**Adjustability**

- 3" glide stem permits 2 1/2" height adjustment
- Slotted at 1" centers
- Over panels, 8" and 16" (Non-slotted)

**Door**

- 2 widths, glazed/solid, lockable, reversible
- 2 sliding door widths, non-lockable

**Flexibility**

- Universal connector

**Panel Finishes**

- Fabric, air flow accessory, tempered glass, laminate, whiteboard, corkboard (at base only)

**ELECTRICAL FOR BOULEVARD 1 PANELS**

**Features**

- Customized power capabilities in each panel
- State-of-the-art snap-in electrical
- 8 wire with 3 regular 15 AMP circuits and 1 isolated 15 AMP circuit.
- 3N and 8K electrical available upon request.
- Snap-in installation - harnesses, junction boxes, duplexes
- Accessibility makes changing circuits easy
- Flexibility in choice of duplexes within panel: choice of circuits for each duplex; choice of quantity of duplexes (1 or 2 duplexes per panel)

- Electrical cords are concealed
- Separate large channel for data
- Change electrical without moving pedestals
- Lower installation/reconfiguration costs
- Data terminals snap into cable holder
- Floor or ceiling feed
- Duplexes accessible from both sides

**ELECTRICAL FOR SYSTEM 3 PANELS**

**Features**

- Customized power capabilities in each panel
- State-of-the-art snap-in duplex receptacles
- 8 wire with 3 regular 15 AMP circuits and 1 isolated 15 AMP circuit
- Snap-in installation - harnesses, junction boxes, duplexes

- Accessibility makes changing circuits easy
- Flexibility in choice of duplexes within panel
- Data terminals snap into base raceway cover and mid panel electrical tile
- Floor or ceiling feed
- Duplexes accessible from both sides

**WORKSURFACES / HARDWARE****Features**

- One universal cantilever support
- Pedestal eliminates need for end panel/cantilever
- Grommets are not needed
- Continuous cable accessibility across back
- Adjustable to any height, in 1" increments.
- Flush abutment side edge minimize seam crevice
- Metal-to-metal connections (Metal Inserts)
- Additional cable manager under worksurface

**Construction**

- Medium-density particle board 1 1/16" thick

**Sizes**

- 3 Depths: 18", 24" and 30"
- 12 Widths: 18" to 84" in 6" increments

**Finishes**

- Tops: High Pressure Laminate, Low Pressure Laminate or Wood
- Edges: Edge banded PVC or Wood

**Types**

- Transaction, keyboard, rectangular worksurface, corner, curved, D-top, P-top, Arc-top and freestanding

**OVERHEAD STORAGE****Features**

- Completely enclosed unit for 16" overheads
- Shipped fully assembled or KD
- 13.5" inside height for oversized binders
- Metal-to-metal connection
- Lock secures into bottom shelf
- Doors operate smoothly
- Flipper door retrofittable on site
- Safety bracket used for extra support
- Reinforcement built in for larger unit
- Can be removed and reconfigured without disassembly

**Fronts**

- Open or closed fronts

**Sizes**

- Overheads - 6 widths in 6" increments
- Shelves - 7 widths in 6" increments
- 16" deep welded overhead for EDP, ring binder, letter/legal
- 12" deep KD overhead
- 15" deep KD overhead with "soft-to-the-touch" handles

**Paint**

- Dry epoxy powder coating

**PEDESTALS****Features**

- Double wall construction on all drawer fronts
- Fully progressive suspension system
- Full-width pull, "Hytrel®" or "soft-to-the-touch" handles on drawer fronts
- Worksurface supporting option
- Full extension roller bearing glides on all file drawers
- Rubber bumpers for quietness
- Movable drawer divider/pencil tray
- 25" filing capacity for file drawers (only in 30" pedestal)
- Durable epoxy finish
- Keyed alike options
- Box/Box/File standard with pencil tray

**Construction**

- Double wall drawer fronts
- 18-20 gauge steel

**Sizes**

- 18", 24", 30" depth

**Types**

- Worksurface-Supporting, Mobile, Freestanding

**Paint**

- Dry epoxy powder coating



**HOW BOULEVARD 1 CAN REDUCE YOUR COSTS**

**Finished Panel**

- No inventory costs for connectors, trim caps, top caps, kick plates and clips.
- Less time required to install, or to disassemble, move and re-install.

**Fewer Parts**

- Only 1 universal cantilever and 3 brackets are needed to build most workstations.
- Easy to attach and remove components from panels.
- Universal post for 2-way, 3-way and 4-way applications.

**Desk Height Electric**

- Ease of initial electrical installation lowers energy management costs.
- Snap-in electrical components reduce reconfiguration costs.
- Can customize power in each panel, pay only for what is required.

**Simplified Specifications**

- Fewer parts and components make specifying, ordering, and verifying less work.
- Product fits a 6" planning module.

**Replaceable Panels**

- Panels can be re-upholstered on site.

**Communications/Data Channel**

- Desk height data channel reduces time to install and change cables.

**Floor to Ceiling Enclosed Office:**

- Re-usable enclosed offices with doors eliminate future costs for drywall demolition, new construction, mess and extensive cash flow.
- Depreciation expense indirectly increases cash flow.

**Warranty**

- Limited Lifetime Warranty on materials and workmanship.

**Product**

- Priced less than most other "A" Grade panel systems.

**HOW BOULEVARD SYSTEM 3 CAN REDUCE YOUR COSTS**

**Finished Panel**

- No inventory costs for connectors, top caps, kick plates and clips.
- Less time required to install, or to disassemble, move and re-install.

**Fewer Parts**

- Only 1 universal cantilever and 3 brackets are needed to build most workstations.
- Easy to attach and remove components from panels.
- Universal post for 2-way, 3-way and 4-way applications.

**Base Panel Electric System**

- Ease of initial electrical installation lowers energy management costs.
- Snap-in electrical components reduce reconfigurations costs.
- Can customize power in each panel, pay only for what is required.

**Simplified Specifications**

- Fewer parts and components make specifying, ordering, and verifying less work.
- Product fits a 6" planning module.

**Replaceable Panel Tiles**

- Over Panels and face tiles can be added and interchanged as needs change.

**Communications/Data Channel**

- Base and top lay-in communications channel reduces time to install and change cables.

**Warranty**

- Limited Lifetime Warranty on materials and workmanship.

**Product**

- Priced less than most other "A" Grade panel systems.

**VALUE-ADDED BENEFITS**

On the following pages, we selected a grouping of Boulevard 1, System 3 configurations, some with electrical components and task lights, to give you a better understanding of our product's specifications as they relate to workstations. Our objective is to not only illustrate applications using panels and components, but also to have this serve as a pricing exercise.

**All of the value-added benefits of the Boulevard 1 are standard as follows:**

- Desk height power and data capabilities.
- Finished panel including top, corner and end caps.
- Sectional panel with multiple fabric options.
- Ease of installation and reconfigurations.
- Removable fabric for on-site refurbishing.
- Exceptional storage capacity in pedestals, overheads, lateral files, storage cabinets and towers.
- Simplified specifications.

**All of the value-added benefits of the Boulevard System 3 are standard as follows:**

- Base power and data capabilities.
- Finished panel including top and corner.
- Monolithic or Pass-Thru panels with multiple fabric options.

- Ease of installation and reconfiguration.
- Removable fabric tiles in Pass-Thru Panels for on-site refurbishing.
- Exceptional storage capacity in pedestals, overheads, lateral files, storage cabinets and towers.
- Simplified specifications.

**All of the value-added benefits of the Diet System are standard as follows:**

- Finished panel including top, corner and end caps.
- Sectional panels with multiple fabric options.
- Ease of installation and reconfigurations.
- Removable fabric for on-site refurbishing.
- Exceptional storage capacity in pedestals, overheads, lateral files, storage cabinets and towers.
- Simplified specifications.

**When specifying Boulevard 1, Boulevard System 3 or Diet, you benefit from the ability to:**

- Customize the energy management.
- Minimize the number of necessary parts.
- Offer a competitive list price.

NOTE: If Key Alike Instructions are not submitted to GLOBAL CONTRACT with the Customer's Purchase Order, all components will be keyed randomly.

**WOOD GRAIN (WG) LAMINATE DIRECTION**

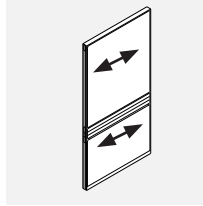

\* Panel general direction will default to vertical if monolithic panel is 54" high and if raceway panels are on same order.

All Panels  
With Exception of 66" or higher panels, the grain is vertical.

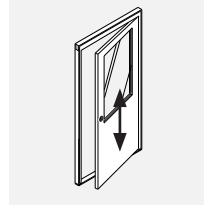

**BPD**  
Doors.

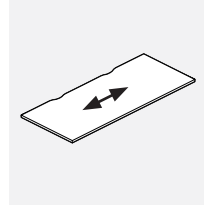

**BWS**  
Worksurfaces.

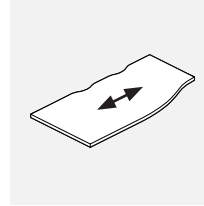

**BWSC**  
Worksurfaces.

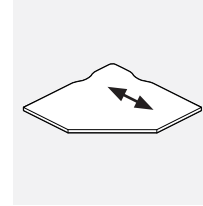

**BWCF**  
Corner Worksurfaces.

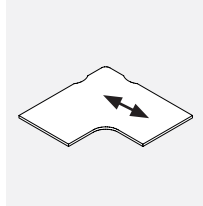

**BWCL**  
Corner Worksurfaces.

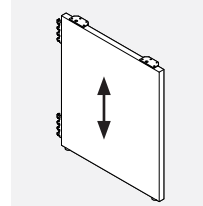

**BHFG**  
Full Gable.

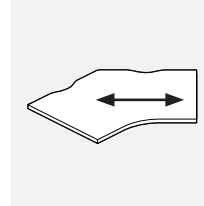

**BWAC** Angled Corner  
Worksurfaces

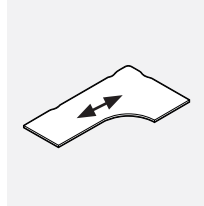

**BWCE**  
Extended Worksurfaces.

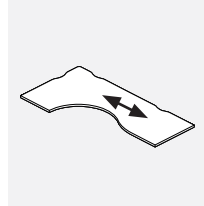

**BWCEC**  
Extended Worksurfaces.

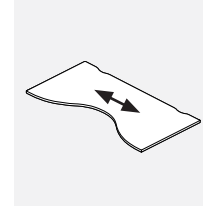

**BWBT**  
Bow Tie Worksurfaces.

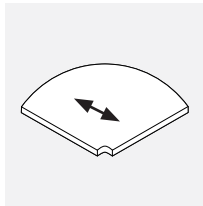

**BWR**  
Radius Worksurfaces.

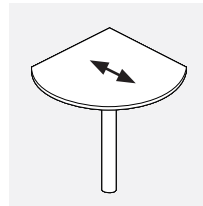

**BWRTD**  
Teardrop Worksurfaces.

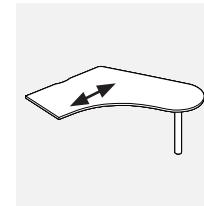

**BWC**  
Extended "D"  
Worksurfaces.

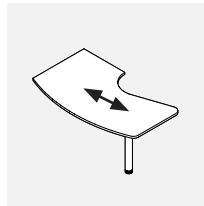

**BWSL**  
Curvilinear  
Worksurfaces.

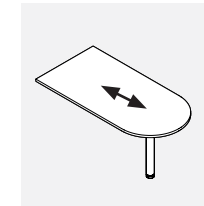

**BWD**  
Worksurfaces.

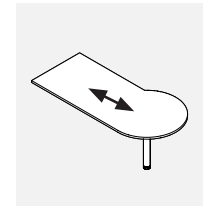

**BWP**  
Worksurfaces.

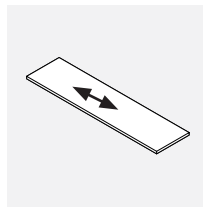

**BWT**  
Transaction  
Worksurfaces.

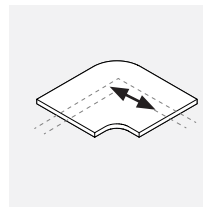

**BWTC**  
Corner Transaction  
Worksurfaces.



**BWTT**  
Transaction  
Worksurfaces.

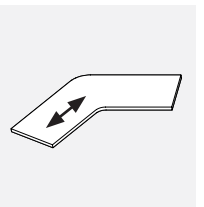

**BWTAC**  
Transaction  
Worksurfaces.

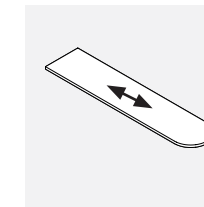

**BWTD "D"**  
Transaction  
Worksurfaces.

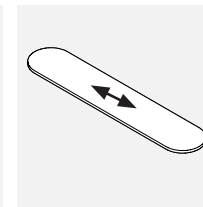

**BWTD "D"**  
Transaction  
Worksurfaces.

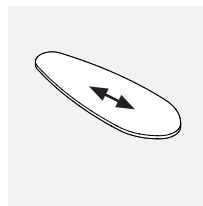

**BWTE**  
Ellipse Transaction  
Worksurfaces

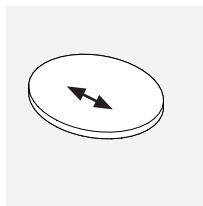

**BWTP**  
Round Transaction  
Worksurfaces.

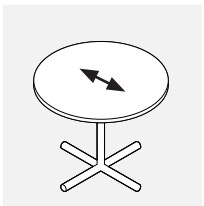

**BWCD**  
Round Tables.

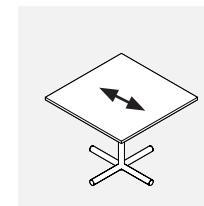

**BWSQ**  
Square Tables.

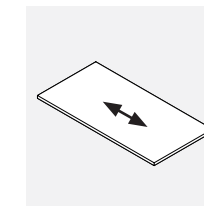

**BK**  
Desking Worksurfaces.

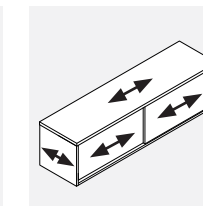

**BSP**  
Laminate Divider  
Storage

## BOULEVARD 1 PANEL SYSTEM

The Boulevard philosophy is based on simplicity. A product that is simple to install... simple to reconfigure... and simple to specify, without sacrificing delivery time or quality.

Technically superb and exceptionally precise aluminum extrusion and die-cast fittings achieve exact levels of consistency, panel after panel; everything fits, aligns, and assembles, first time, every time. Most of all it requires very few of the "small parts" associated with most systems. This cross-market integration is celebrated in Boulevard.

Truly a system of broad application, whether installed in a high-tech environment, factory application or executive office, Boulevard will perform! We invite you to share with us a product designed, built and marketed for a global economy.

### Our Mission

Our mission is to continue to develop and offer innovative, quality office furniture to value-oriented customers, through a dealer network that provides consistent, high quality service. Our approach in the contract furniture industry is to focus on customer concerns and needs to develop products that minimize your costs of ownership. It represents the culmination of creativity, industry expertise, specialists,

and integrity to help you achieve cost-effective solutions to problems. Our vision is to create a company-wide environment that supports constant improvement and promotes customer satisfaction. We believe that as good as we are today, we must be better tomorrow. Thus, our desire to improve is both continuous and tireless.

### Environmental Commitment

At Teknion, protecting the next generations' environment is of paramount concern. Teknion believes that it is our responsibility to help protect the environment for future generations. We continue to operate with the environment in mind, making wise business decisions that help protect the earth and its precious natural resources. Our manufacturing procedure incorporates the latest technology for painting products, using a dry epoxy powder or gel paint. This process produces no toxic residue, and therefore is environmentally safe, while other manufacturers still use the wet paint process. Our packaging, veneer selections, and reduction in waste programs all contribute to a better environment. In addition, our concern for the reduction of finishing emissions and wood dust has resulted in a healthier work environment in many ways, including this price book, printed on recycled paper.

## TECHNICAL INFORMATION

### Panels

- All panels are 2 5/8" thick.
- Lightweight aluminum box frame construction creates superior panel rigidity.
- Panel frame finish is durable epoxy powder coated.
- Hang-on capabilities at 1" increments.
- Patented "Knuckle-Loc" design provides solid panel-to-panel connection for fast installation and reconfiguration.
- Knuckle lock feature ensures even panel heights throughout installation.
- 3" glide stem permits 2 1/2" height adjustment.
- Panel sizes are actual, eliminating creepage.
- Panels come complete, eliminating need for separate top, corner end trim and clips.
- Fabric is replaceable on site.
- All panels include 2 "Capture Strip" panel connectors.
- Fabric retainer is clear.
- Panels are UL listed and CSA approved and have a Class "A" fire rating except when Customer's Own Material (COM) is used.
- Glazing available in acrylic or tempered glass for straight panels.
- Center septum above raceway overlaid on either side with tackable, 1 1/8" "Sound Absorbent Mineral Board."
- For glazing - Smoke developed index 500.
- For tempered glass, add "TG" to the end of the product code and add 20% to the price regardless of fabric grade.
- Solid metal sheet is an OPT option and price accordingly, however, the sheets are 48" wide and cannot be specified on 48" and wider unless they are railroaded. Contact your Customer Service Representative for more information.

### Panel Options

- Laminate, whiteboard, or corkboard may be substituted for fabric on panels only, not raceways, see "OPT" column.
- Laminate and whiteboard are held in place with a PVC retainer matching the frame color and can be retrofitted on site.
- Laminate and whiteboard options reduce the acoustical value of the panel.

### Raceway Options

- Raceways are standard in PVC matching the panel frame finish.
- Fabric-Covered Raceway (FRC) available. Aluminum raceway available.
- Wood veneer raceway available.
- Face-mount electrical raceway available.
- Face-mount openings are 1.5" x 2.85" for electrical and 1.37" x 2.755" for data.
- Cable capacity in raceways is 83 - 0.220" dia. cables (cat.6).

### Desk Height Management

- Desk height electrical and communication raceway system.

- State-of-the-art engineering.
- Snap-in modularity of all electrical components including harnesses, junction boxes, duplexes and circuit designations.
- All power and data outlets are easily accessible from both sides of panel.
- 8 wire system with 4, 15 amp circuits (including 1 dedicated circuit).
- Optional face-mount electrical with 2 duplexes per panel side.
- Outlet and circuit changes accomplished without disruption to workstation.
- Large raceway cavity permits storage of excess cables and equipment cords.
- Total flexibility for 8 wire system: choice of 1, 2 or 4 duplexes per panel; choice of circuitry in each duplex.
- Unique design of fire retardant PVC raceway cover permits access to raceway without disruption to equipment on worksurfaces.
- Clip-on communication management channel (BECC01 and BPH001) included with each raceway panel.
- Communication management channel accepts modular Data/Comm terminals (not supplied by Teknion Inc.).

### Posts

- Enables connection for multiple panel runs such as 90°, 45° or 60° angles and 2 way, 3 way or 4 way.
- Provides route for base, ceiling, and worksurface cable entry to a panel.
- Self leveling feature maintains even height of all connected panels.
- Solid lightweight aluminum extrusion fits together through a unique "Knuckle-Loc" design providing rigid post-to-panel connection.
- Includes all required panel connectors and caps.
- Posts add 2 5/8" to a panel run.
- Posts are 1/8" oversized to allow for "panel wrap around" of freestanding desks.
- For all panel runs with multiple posts, this 1/8" must be allotted for.

**PANELS - GUIDELINES FOR ORDERING PRODUCT**

**Codes**

The product guide uses a numbering system with meaningful alphanumeric characters to create a simple-to-understand product number. This makes specifying the product much easier and more accurate.

Example of Panel: **BPRA6636 CHR CHR**

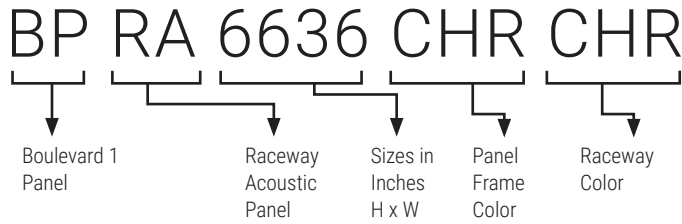

- AN50 Inside Lower Fabric
- AN50 Inside Upper Fabric
- BE21 Outside Lower Fabric
- BE21 Outside Upper Fabric

**How to Specify**

Specify Boulevard 1 panel type and size by code.  
 Specify panel frame finish - ie. CHR (Charcoal).  
 Specify PVC raceway finish - ie. CHR (Charcoal). If PVC raceway color not specified at time of order, default will be the panel frame color.  
 Specify all four panel fabric options if necessary.  
 Some fabrics have directional pattern and cannot be applied horizontally or vertically. Panels wider than 60" will have fabrics applied horizontally (railroad).  
 Please specify if you want adjacent panels and the rest of the installation upholstered the same way.

Example of Post: **BHP066 CHR**

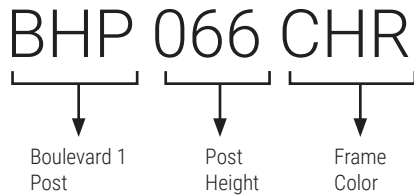

**How to Specify**

Specify Boulevard 1 post by code.  
 Specify frame color - ie. CHR (Charcoal).

**Raceways**

**PVC:**

Standard, at time of order, includes 2 covers.  
 Standard, when ordering individuals: RCSxxCOL.  
 Face-mount raceways: RCWxxD.

**Fabric:**

Standard, at time of order: RCWxxFAB, \$33 per side, sold as pair, panel-mounted.  
 Standard, when ordering individuals: 1006FRCxx, shipped separately.  
 Face-mount raceways: FCRxxD.

**Aluminum:**

Standard, when ordering individuals: BARCxx,  
 Face-mount raceways: RCAxxD.

**ORDERS**

**Each Order Must Include:**

- Purchase Order
- Layout showing where the image(s) appear in the run of panels.
- A completed Price Chart, showing the location of the image(s) on each appropriate panel.

• Artwork must be submitted in accordance with the following artwork specifications.

**NOTE:** Final artwork specification approval must be given before order can be processed.

**Transfer Devices**

- E-mail up to 10MB to your Teknion Customer Service Representative.
- Courier CD/DVD/USB stick to your Teknion Customer Service Representative.

**ARTWORK SPECIFICATIONS**

Non-Photographic artwork should be vector art, saved in Adobe Illustrator (.ai) or as an EPS (.eps)

All bitmap or photographic artwork has to be at a minimum of 100 dpi at the full size of the panel to be printed.

We accept Adobe CS5 files.

Any linked files must be included or imbedded.

Leave any PSD files unflattened

All fonts must be converted to outlines.

Do not convert to CMYK, leave all images as RGB if possible

No Word, Powerpoint, Publisher or other Microsoft files can be used.

Include a PDF or .jpg for reference when sending native Photoshop or Illustrator format files.

**COLOR MATCHING**

A Pantone color reference must be supplied or we cannot accept responsibility for correct color.

When it is not possible to refer to Pantone colors, we will do our best to meet your requirements.

**IMAGE CLARITY**

We will advise should the selected image not lend itself to the element size requested.

**NOTE**

We reserve the right to put an order on hold when the files are found to be incomplete or when documents have been either incorrectly saved. Fonts not

converted to curves or the job appears not to be commercially acceptable.

**IMAGE BLEED**

To facilitate placement on the panel. Extension of the image past the finished visible area of the panel (bleed) is required

• Boulevard Panels need a 5" Bleed on all sides.

**EXAMPLE OF IMAGE RESOLUTION**

The resolution required for a 36" wide x 24" high Boulevard panel at 100 dpi (minimum resolution)

The resolution required for a 36 wide x 24 high Boulevard panel at 300 dpi (higher quality)

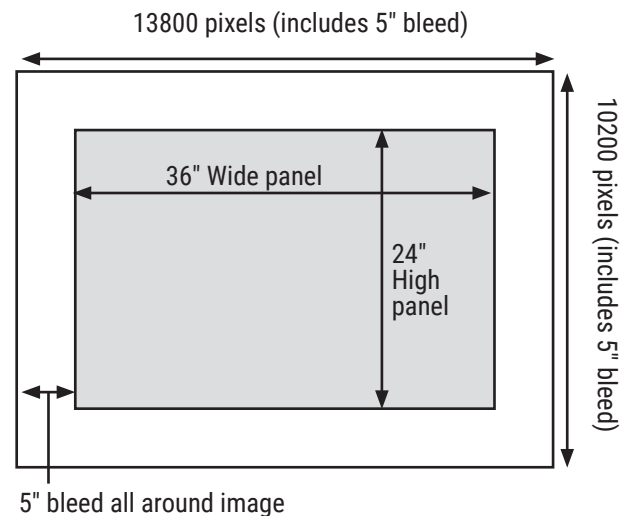
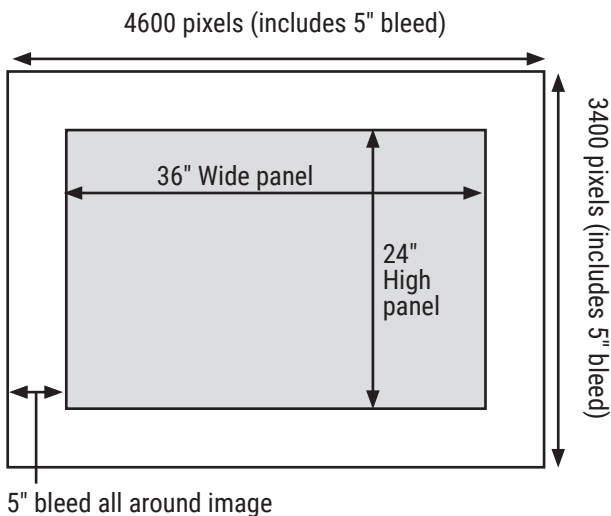

**Pricing, Initial Set-Up Charge per Order: \$235 net**

**Boulevard 1 Panels • Below Raceway Only**

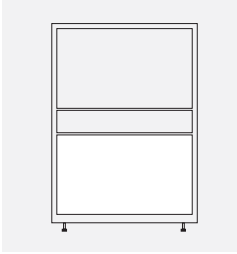

- This List applies to the following panels:
- BPRAXxxx
- BPRGXxxx
- BPRPxxxx
- BPARxxxx

PANEL HEIGHT	PANEL WIDTH	LIST PRICE
29"	24"	411
29"	30"	480
29"	36"	561
29"	42"	632
29"	48"	711
29"	54"	782
29"	60"	852
29"	66"	921
29"	72"	993

**Boulevard 1 • Above Raceway Only**

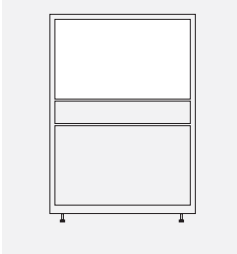

- This List applies to the following panels:
- BPRAXxxx
- BPRFxxxx

PANEL WIDTH	HEIGHT	LIST PRICE						
	42"	50"	54"	58"	66"	74"	82"	
24"	N/A	248	290	331	421	512	592	
30"	N/A	292	334	390	501	600	701	
36"	N/A	341	395	450	572	691	811	
42"	N/A	381	450	520	651	782	921	
48"	N/A	431	508	581	732	880	1052	
54"	N/A	471	551	632	800	971	1132	
60"	N/A	512	600	691	881	1060	1241	
66"	N/A	551						
72"	N/A	600						

**Boulevard Fabric Acoustic Panels**

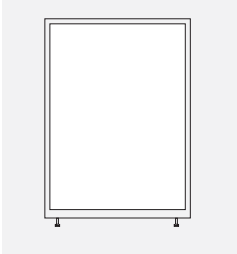

- This List applies to the following panels:
- BPFAXxxx

PANEL WIDTH	HEIGHT	LIST PRICE						
	42"	50"	54"	58"	66"	74"	82"	
24"	540	632	678	722	800	892	981	
30"	641	741	797	852	952	1052	1153	
36"	741	860	921	981	1101	1213	1333	
42"	841	971	1042	1112	1241	1382	1512	
48"	941	1091	1169	1241	1392	1543	1693	
54"	1042	1203	1289	1373	1532	1701	1872	
60"	1132	1321	1413	1502	1683	1862	2041	
66"	1221	1413						
72"	1321	1532						

**Boulevard 1 Over Panels**

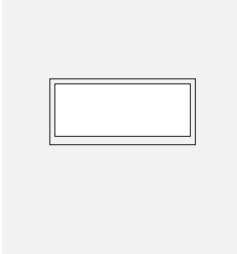

- This List applies to the following Panels:
- BPOFxxxx

PANEL WIDTH	HEIGHT	LIST PRICE				
	8"	16"	24"	37"	42"	
24"	191	280	361	501	561	
30"	226	331	431	592	660	
36"	260	381	491	681	761	
42"	301	431	561	782	860	
48"	331	480	621	860	961	
54"	372	540	691	961	1060	
60"	401	592	751	1052	1162	
66"	431	632	811	1132	1252	
72"	471	681	871	1221	1351	

Note: Prices shown are an upcharge to the panel price, please add to the list price of panel which you are specifying the graphic for.

**BPRA • Acoustical Raceway Panel**

- Fabric above the raceway provides visual and acoustic privacy.
- Center septum above and below raceway overlaid on either side with tackable, 1 1/8" "Sound absorbent mineral board."
- Center septum below raceway overlaid on either side with 1 1/8" Mineral board.
- Acoustic rating of .80 NRC and 26 STC.
- OPT\* = Laminate or Whiteboard.

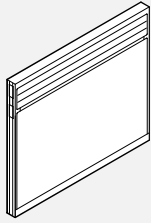

37" High

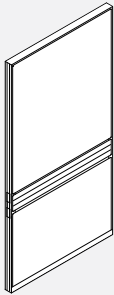

72" Wide

PRODUCT CODE	PRICE			SIZE/INCHES			WEIGHT VOL	
	GR1	GR2	OPT*	H	W	D	LBS	FT <sup>3</sup>
BPRA3718	473	482	497	37	18	2.61	18	1.58
BPRA3724	524	536	547	37	24	2.61	21	2.054
BPRA3730	576	588	601	37	30	2.61	25	2.528
BPRA3736	626	670	717	37	36	2.61	28	3.002
BPRA3742	681	727	772	37	42	2.61	32	3.476
BPRA3748	732	776	820	37	48	2.61	35	3.950
BPRA3754	786	830	875	37	54	2.61	39	4.424
BPRA3760	835	881	925	37	60	2.61	44	4.898
BPRA3766	1111	1165	1220	37	66	2.61	50	5.499
BPRA3772	1387	1440	1495	37	72	2.61	56	6.000
BPRA4218	473	497	523	42	18	2.61	22	1.782
BPRA4224	524	550	578	42	24	2.61	28	2.317
BPRA4230	576	600	627	42	30	2.61	32	2.852
BPRA4236	626	678	732	42	36	2.61	36	3.387
BPRA4242	681	733	786	42	42	2.61	40	3.921
BPRA4248	734	789	835	42	48	2.61	44	4.456
BPRA4254	786	836	891	42	54	2.61	48	4.991
BPRA4260	835	886	940	42	60	2.61	52	5.525
BPRA4266	1199	1305	1420	42	66	2.61	62	6.148
BPRA4272	1565	1671	1783	42	72	2.61	72	6.770
BPRA5018	536	562	589	50	18	2.61	25	2.106
BPRA5024	590	627	669	50	24	2.61	30	2.738
BPRA5030	647	685	728	50	30	2.61	35	3.370
BPRA5036	705	767	835	50	36	2.61	40	4.002
BPRA5042	757	820	891	50	42	2.61	45	4.634
BPRA5048	816	879	946	50	48	2.61	50	5.266
BPRA5054	869	932	1002	50	54	2.61	55	5.898
BPRA5060	928	992	1058	50	60	2.61	60	6.530
BPRA5066	1270	1377	1489	50	66	2.61	70	7.300
BPRA5072	1612	1718	1830	50	72	2.61	80	8.000
BPRA5418	582	605	635	54	18	2.61	27	2.250
BPRA5424	641	679	719	54	24	2.61	32	2.960
BPRA5430	696	733	775	54	30	2.61	37	3.689
BPRA5436	752	830	910	54	36	2.61	42	4.318
BPRA5442	814	891	970	54	42	2.61	47	4.934
BPRA5448	868	944	1025	54	48	2.61	52	5.666
BPRA5454	928	1004	1084	54	54	2.61	59	6.398
BPRA5460	982	1058	1139	54	60	2.61	62	7.035

**BPRA • Acoustical Raceway Panel ... Continued**

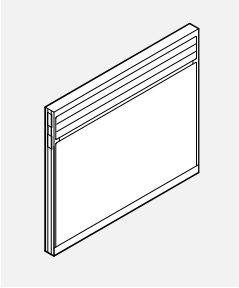

37" High

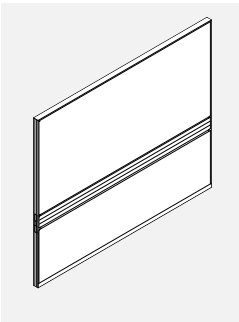
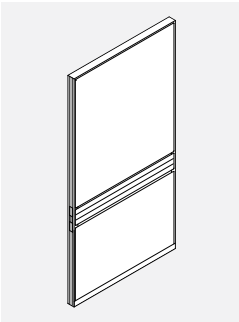

72" Wide

- Fabric above the raceway provides visual and acoustic privacy.
- Center septum above and below raceway overlaid on either side with tackable, 1 1/8" "Sound absorbent mineral board."
- Center septum below raceway overlaid on either side with 1 1/8" Mineral board.
- Acoustic rating of .80 NRC and 26 STC.
- OPT\* = Laminate or Whiteboard.

PRODUCT CODE	PRICE			SIZE/INCHES			WEIGHT VOL	
	GR1	GR2	OPT*	H	W	D	LBS	FT <sup>3</sup>
BPRA5818	582	605	635	58	18	2.61	28	2.431
BPRA5824	641	679	719	58	24	2.61	33	3.160
BPRA5830	696	733	775	58	30	2.61	38	3.889
BPRA5836	752	830	910	58	36	2.61	43	4.618
BPRA5842	814	891	970	58	42	2.61	48	5.347
BPRA5848	868	944	1025	58	48	2.61	53	6.076
BPRA5854	928	1004	1084	58	54	2.61	58	6.806
BPRA5860	982	1058	1139	58	60	2.61	63	7.535
BPRA6618	625	662	703	66	18	2.61	32	2.755
BPRA6624	685	736	789	66	24	2.61	37	3.581
BPRA6630	746	795	852	66	30	2.61	42	4.407
BPRA6636	804	892	986	66	36	2.61	48	5.234
BPRA6642	863	952	1048	66	42	2.61	53	6.060
BPRA6648	925	1014	1110	66	48	2.61	58	6.887
BPRA6654	981	1069	1164	66	54	2.61	63	7.713
BPRA6660	1040	1129	1224	66	60	2.61	68	8.539
BPRA7418	678	712	754	74	18	2.61	34	3.079
BPRA7424	735	786	840	74	24	2.61	39	4.002
BPRA7430	795	848	901	74	30	2.61	45	4.926
BPRA7436	859	961	1068	74	36	2.61	50	5.850
BPRA7442	922	1024	1130	74	42	2.61	55	6.773
BPRA7448	978	1079	1186	74	48	2.61	60	7.697
BPRA7454	1040	1142	1251	74	54	2.61	65	8.620
BPRA7460	1103	1204	1311	74	60	2.61	70	9.544
BPRA8218	732	767	810	82	18	2.61	36	3.403
BPRA8224	794	858	925	82	24	2.61	42	4.424
BPRA8230	859	922	992	82	30	2.61	48	5.444
BPRA8236	923	1036	1157	82	36	2.61	54	6.465
BPRA8242	982	1096	1219	82	42	2.61	60	7.486
BPRA8248	1048	1160	1279	82	48	2.61	66	8.507
BPRA8254	1111	1224	1345	82	54	2.61	72	9.528
BPRA8260	1176	1290	1409	82	60	2.61	78	10.549



**BPRG • Partly-Glazed Raceway Panel**

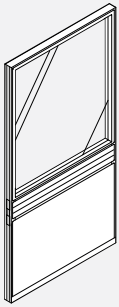

- Glazing above the raceway provides visual accessibility.
- Center septum below raceway overlaid on either side with 1 1/8" "Sound absorbent mineral board."
- Glazing replaceable on site.
- Standard glaze is acrylic.
- OPT\* = Laminate or Whiteboard.

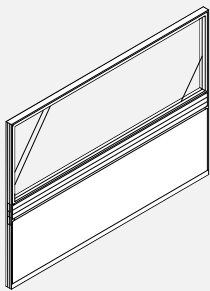

72" Wide

PRODUCT CODE	PRICE			SIZE/INCHES			WEIGHT VOL	
	GR1	GR2	OPT*	H	W	D	LBS	FT <sup>3</sup>
BPRG4218	635	644	660	42	18	2.61	22	1.782
BPRG4224	692	717	744	42	24	2.61	28	2.317
BPRG4230	751	778	805	42	30	2.61	32	2.852
BPRG4236	814	863	917	42	36	2.61	36	3.387
BPRG4242	869	921	973	42	42	2.61	40	3.921
BPRG4248	930	981	1035	42	48	2.61	44	4.456
BPRG4254	992	1040	1095	42	54	2.61	48	4.991
BPRG4260	1049	1100	1153	42	60	2.61	52	5.525
BPRG4266	1385	1437	1493	42	66	2.61	62	6.148
BPRG4272	1720	1772	1828	42	72	2.61	72	6.770
BPRG5018	702	712	729	50	18	2.61	24	2.106
BPRG5024	761	787	814	50	24	2.61	29	2.738
BPRG5030	824	851	875	50	30	2.61	34	3.370
BPRG5036	886	938	992	50	36	2.61	39	4.002
BPRG5042	944	995	1049	50	42	2.61	44	4.634
BPRG5048	1008	1058	1111	50	48	2.61	48	5.266
BPRG5054	1069	1119	1175	50	54	2.61	54	5.898
BPRG5060	1129	1180	1231	50	60	2.61	59	6.530
BPRG5066	1446	1501	1556	50	66	2.61	70	7.300
BPRG5072	1765	1818	1873	50	72	2.61	78	8.000
BPRG5418	741	752	767	54	18	2.61	27	2.250
BPRG5424	799	825	849	54	24	2.61	30	2.960
BPRG5430	862	887	914	54	30	2.61	35	3.689
BPRG5436	925	977	1030	54	36	2.61	40	4.318
BPRG5442	986	1037	1090	54	42	2.61	45	4.934
BPRG5448	1049	1100	1154	54	48	2.61	49	5.666
BPRG5454	1111	1162	1215	54	54	2.61	55	6.398
BPRG5460	1173	1224	1277	54	60	2.61	60	7.035
BPRG5818	778	789	805	58	18	2.61	26	2.431
BPRG5824	838	862	891	58	24	2.61	31	3.160
BPRG5830	901	925	954	58	30	2.61	36	3.889
BPRG5836	965	1015	1069	58	36	2.61	41	4.618
BPRG5842	1027	1078	1132	58	42	2.61	46	5.347
BPRG5848	1090	1140	1192	58	48	2.61	51	6.076
BPRG5854	1153	1203	1258	58	54	2.61	56	6.806
BPRG5860	1218	1267	1319	58	60	2.61	61	7.535
BPRG6618	842	854	868	66	18	2.61	29	2.755
BPRG6624	908	935	961	66	24	2.61	34	3.581
BPRG6630	975	1002	1027	66	30	2.61	39	4.407
BPRG6636	1043	1092	1145	66	36	2.61	45	5.234
BPRG6642	1111	1161	1216	66	42	2.61	50	6.060
BPRG6648	1178	1227	1279	66	48	2.61	55	6.887
BPRG6654	1241	1295	1346	66	54	2.61	60	7.713
BPRG6660	1313	1365	1420	66	60	2.61	65	8.539
BPRG7418	910	922	938	74	18	2.61	30	3.079
BPRG7424	981	1008	1033	74	24	2.61	35	4.002
BPRG7430	1052	1102	1155	74	30	2.61	41	4.926
BPRG7436	1121	1171	1224	74	36	2.61	46	5.850
BPRG7442	1191	1242	1296	74	42	2.61	51	6.773
BPRG7448	1264	1313	1369	74	48	2.61	56	7.697
BPRG7454	1335	1385	1437	74	54	2.61	61	8.620
BPRG7460	1418	1466	1520	74	60	2.61	66	9.544
BPRG8218	962	973	989	82	18	2.61	31	3.403
BPRG8224	1038	1065	1091	82	24	2.61	36	4.424
BPRG8230	1118	1143	1171	82	30	2.61	43	5.444
BPRG8236	1196	1250	1301	82	36	2.61	49	6.465
BPRG8242	1279	1331	1382	82	42	2.61	55	7.486
BPRG8248	1356	1407	1462	82	48	2.61	61	8.507
BPRG8254	1436	1486	1540	82	54	2.61	67	9.528
BPRG8260	1524	1575	1630	82	60	2.61	73	10.549

**BPRF • Air Flow Panel**

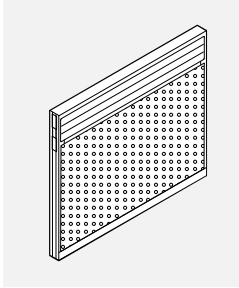

37" High

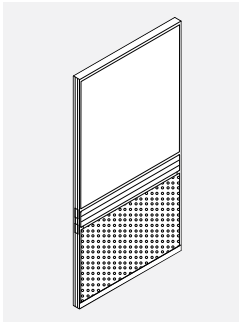

72" Wide

- Double wall of perforated metal below the raceway allows air to flow freely through the bottom of the panel.
- Center septum above raceway overlaid on either side with tackable, 1 1/8" "Sound absorbent mineral board."
- OPT\* = Laminate or Whiteboard.

PRODUCT CODE	PRICE			SIZE/INCHES			WEIGHT		VOL FT <sup>3</sup>
	GR 1	GR 2	OPT*	H	W	D	LBS		
BPRF3718	528			37	18	2.61	18	1.58	
BPRF3724	598			37	24	2.61	21	2.054	
BPRF3730	670			37	30	2.61	25	2.528	
BPRF3736	744			37	36	2.61	28	3.002	
BPRF3742	815			37	42	2.61	32	3.476	
BPRF3748	886			37	48	2.61	35	3.950	
BPRF3754	959			37	54	2.61	39	4.424	
BPRF3760	1027			37	60	2.61	44	4.898	
BPRF3766	1386			37	66	2.61	50	5.449	
BPRF3772	1743			37	72	2.61	56	6.000	
BPRF4218	545	550	557	42	18	2.61	22	1.782	
BPRF4224	620	625	632	42	24	2.61	28	2.317	
BPRF4230	692	698	705	42	30	2.61	32	2.852	
BPRF4236	766	778	792	42	36	2.61	36	3.387	
BPRF4242	840	852	865	42	42	2.61	40	3.921	
BPRF4248	912	923	939	42	48	2.61	44	4.456	
BPRF4254	988	999	1014	42	54	2.61	48	4.991	
BPRF4260	1062	1073	1089	42	60	2.61	52	5.525	
BPRF4266	1494	1549	1604	42	66	2.61	62	6.270	
BPRF4272	1927	1981	2036	42	72	2.61	72	6.770	
BPRF5018	609	624	638	50	18	2.61	25	2.106	
BPRF5024	686	700	712	50	24	2.61	30	2.738	
BPRF5030	765	777	790	50	30	2.61	35	3.370	
BPRF5036	841	865	894	50	36	2.61	40	4.002	
BPRF5042	922	946	973	50	42	2.61	45	4.634	
BPRF5048	998	1024	1051	50	48	2.61	50	5.266	
BPRF5054	1073	1100	1127	50	54	2.61	55	5.898	
BPRF5060	1151	1177	1203	50	60	2.61	60	6.530	
BPRF5066	1592	1645	1700	50	66	2.61	70	7.300	
BPRF5072	2030	2083	2139	50	72	2.61	80	8.000	
BPRF5418	655	675	693	54	18	2.61	27	2.250	
BPRF5424	734	752	772	54	24	2.61	32	2.960	
BPRF5430	815	835	854	54	30	2.61	37	3.689	
BPRF5436	895	930	972	54	36	2.61	42	4.318	
BPRF5442	971	1009	1051	54	42	2.61	47	4.934	
BPRF5448	1051	1087	1129	54	48	2.61	52	5.666	
BPRF5454	1129	1167	1209	54	54	2.61	57	6.398	
BPRF5460	1213	1250	1291	54	60	2.61	62	7.035	

**BPRF • Air Flow Panel ... Continued**

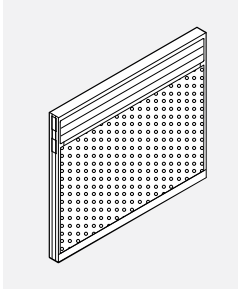

37" High

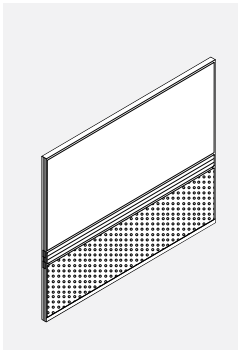
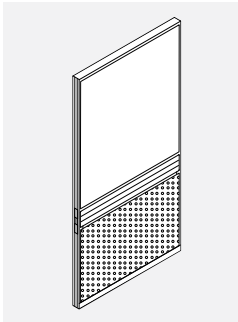

72" Wide

- Double wall of perforated metal below the raceway allows air to flow freely through the bottom of the panel.
- Center septum above raceway overlaid on either side with tackable, 1 1/8" "Sound absorbent mineral board."
- For air flow option above the raceway, add 20% to the Grade 1 price and tag each item with "air flow above raceway." For example: BPRF4218 TAG:\*air flow above raceway.
- OPT\* = Laminate or Whiteboard.

PRODUCT CODE	PRICE			SIZE/INCHES			WEIGHT VOL	
	GR 1	GR 2	OPT*	H	W	D	LBS	FT <sup>3</sup>
BPRF5818	655	674	693	58	18	2.61	28	2.431
BPRF5824	734	751	772	58	24	2.61	33	3.160
BPRF5830	815	833	854	58	30	2.61	38	3.889
BPRF5836	895	930	972	58	36	2.61	43	4.618
BPRF5842	971	1009	1051	58	42	2.61	48	5.347
BPRF5848	1051	1090	1130	58	48	2.61	53	6.076
BPRF5854	1129	1167	1209	58	54	2.61	58	6.806
BPRF5860	1213	1250	1291	58	60	2.61	63	7.535
BPRF6618	698	723	749	66	18	2.61	32	2.755
BPRF6624	783	808	833	66	24	2.61	37	3.581
BPRF6630	862	889	914	66	30	2.61	42	4.407
BPRF6636	941	986	1031	66	36	2.61	48	5.234
BPRF6642	1079	1124	1171	66	42	2.61	53	6.060
BPRF6648	1144	1188	1234	66	48	2.61	58	6.887
BPRF6654	1240	1289	1334	66	54	2.61	63	7.713
BPRF6660	1275	1319	1367	66	60	2.61	68	8.539
BPRF7418	749	775	800	74	18	2.61	34	3.079
BPRF7424	831	856	883	74	24	2.61	39	4.002
BPRF7430	912	938	964	74	30	2.61	45	4.926
BPRF7436	998	1059	1128	74	36	2.61	50	5.850
BPRF7442	1151	1214	1281	74	42	2.61	55	6.773
BPRF7448	1186	1250	1317	74	48	2.61	60	7.697
BPRF7454	1248	1311	1380	74	54	2.61	65	8.620
BPRF7460	1331	1392	1461	74	60	2.61	70	9.544
BPRF8218	805	842	884	82	18	2.61	36	3.403
BPRF8224	894	929	971	82	24	2.61	42	4.424
BPRF8230	973	1011	1053	82	30	2.61	48	5.444
BPRF8236	1070	1140	1215	82	36	2.61	54	6.465
BPRF8242	1186	1258	1332	82	42	2.61	60	7.486
BPRF8248	1240	1311	1385	82	48	2.61	66	8.507
BPRF8254	1377	1445	1517	82	54	2.61	72	9.528
BPRF8260	1403	1474	1548	82	60	2.61	78	10.549

**BPRAE • Raceway Panel Electrical**

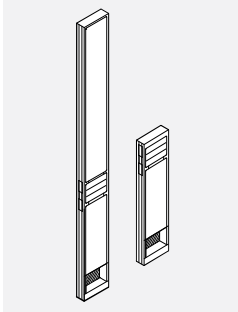

- A 6" raceway panel allows power and communication/data entry along a straight run of panels where a standard post entry cannot be utilized.
- Sections above and below the raceway are upholstered in fabric.
- Inner lower raceway area allows for single or double power feed entry and provides 1.3" x 2.9" opening for communication/data cables.
- All 6" panels must be used in conjunction with a second panel to form a standard panel width. For example: BPRAE6606 + BPRAE6618 is equivalent to BPRAE6624.
- 6" panels are not to be used as a stability panel in a panel run.

PRODUCT CODE	PRICE			SIZE/INCHES			WEIGHT VOL	
	GR 1	GR 2	OPT*	H	W	D	LBS	FT <sup>3</sup>
BPRAE3706	524	538	552	37	6	2.61	24	0.6
BPRAE4206	524	550	579	42	6	2.61	26	0.7
BPRAE5006	590	628	669	50	6	2.61	29	0.8
BPRAE5406	616	654	693	54	6	2.61	31	0.9
BPRAE5806	641	680	719	58	6	2.61	32	0.9
BPRAE6606	685	735	790	66	6	2.61	35	1.0
BPRAE7406	735	787	841	74	6	2.61	37	1.1
BPRAE8206	794	858	924	82	6	2.61	41	1.2

**BPRA • Raceway Panel Filler**

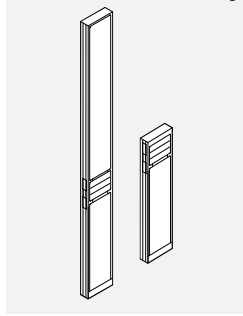

- A 6" (BPRA) raceway panel for use as a filler panel.
- Sections above and below the raceway are upholstered in fabric.
- All 6" panels must be used in conjunction with a second panel to form a standard panel width. For example: BPRA6606 + BPRA6618 is equivalent to BPRA6624.
- 6" panels are not to be used as a stability panel in a panel run.

PRODUCT CODE	PRICE			SIZE/INCHES			WEIGHT VOL	
	GR1	GR2	OPT*	H	W	D	LBS	FT <sup>3</sup>
BPRA3706	524	538	552	37	6	2.61	24	0.6
BPRA4206	524	550	579	42	6	2.61	26	0.7
BPRA5006	590	628	669	50	6	2.61	29	0.8
BPRA5406	616	652	693	54	6	2.61	31	0.9
BPRA5806	641	679	719	58	6	2.61	32	0.9
BPRA6606	685	735	789	66	6	2.61	35	1.0
BPRA7406	735	787	840	74	6	2.61	37	1.1
BPRA8206	794	857	924	82	6	2.61	41	1.2

**BPRP • Pass-Thru Raceway Panel**

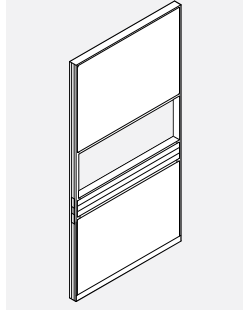

- 10.5" Open cavity allows accessibility between workstations.
- Center septum above 10.5" opening overlaid on either side with tackable, 1 1/8" mineral board.
- Center septum below raceway overlaid on either side with tackable, 1 1/8" mineral board.
- Pass-thru opening is 10 1/2" high starting above the raceway.
- Panel height to top of opening is fixed.

PRODUCT CODE	PRICE			SIZE/INCHES			WEIGHT VOL	
	GR1	GR2	OPT*	H	W	D	LBS	FT <sup>3</sup>
BPRP6618	842	854	868	66	18	2.61	32	2.755
BPRP6624	908	935	961	66	24	2.61	33	3.581
BPRP6630	975	1002	1027	66	30	2.61	38	4.407
BPRP6636	1043	1092	1145	66	36	2.61	44	5.234
BPRP6642	1111	1161	1216	66	42	2.61	49	6.060
BPRP6648	1178	1227	1279	66	48	2.61	54	6.887
BPRP6654	1241	1295	1346	66	54	2.61	59	7.713
BPRP6660	1313	1365	1420	66	60	2.61	64	8.539
BPRP7418	910	941	973	74	18	2.61	31	3.079
BPRP7424	981	1031	1086	74	24	2.61	36	4.002
BPRP7430	1052	1102	1155	74	30	2.61	42	4.926
BPRP7436	1121	1182	1251	74	36	2.61	47	5.850
BPRP7442	1191	1241	1297	74	42	2.61	52	6.773
BPRP7448	1261	1343	1432	74	48	2.61	57	7.697
BPRP7454	1335	1419	1507	74	54	2.61	62	8.620
BPRP7460	1418	1466	1520	74	60	2.61	67	9.544
BPRP8218	962	998	1037	82	18	2.61	34	3.403
BPRP8224	1038	1089	1140	82	24	2.61	40	4.424
BPRP8230	1118	1169	1220	82	30	2.61	46	5.444
BPRP8236	1196	1286	1381	82	36	2.61	52	6.465
BPRP8242	1275	1380	1485	82	42	2.61	58	7.486
BPRP8248	1356	1459	1565	82	48	2.61	64	8.507
BPRP8254	1436	1537	1645	82	54	2.61	70	9.528
BPRP8260	1524	1625	1732	82	60	2.61	76	10.549

**BPRPSD • Pass-Thru Sliding Door Kit**

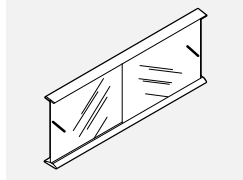

- To close the opening in a Boulevard 1 Pass-Thru Panel.
- Sliding frosted tempered glass doors.

PRODUCT CODE	PRICE	SIZE/INCHES			WEIGHT VOL	
		H	W	D	LBS	FT <sup>3</sup>
BPRPSD36	341	10	36	2.61	13	1.2
BPRPSD42	384	10	42	2.61	16	1.4
BPRPSD48	430	10	48	2.61	18	1.5
BPRPSD54	473	10	54	2.61	20	1.7
BPRPSD60	516	10	60	2.61	22	2.0

**BPAR • Accessory Rail Panel**

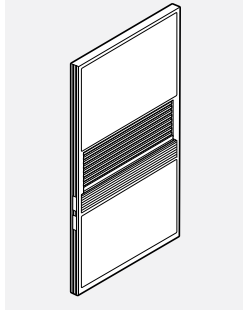

- 12" Accessory rail covers the standard pass-thru opening and allows users to hang accessories.
- Center septum above 12" opening overlaid on either side with tackable, 1 1/8" "Sound absorbent mineral board."
- Center septum below raceway overlaid on either side with 1 1/8" mineral board.
- Accessory rail is 12" high starting above the raceway. Panel height to top of opening is fixed.
- OPT\* = Laminate or Whiteboard.

PRODUCT CODE	PRICE			SIZE/INCHES			WEIGHT VOL	
	GR 1	GR 2	OPT*	H	W	D	LBS	FT <sup>3</sup>
BPAR6618	1035	1048	1062	66	18	2.61	35	2.755
BPAR6624	1124	1149	1177	66	24	2.61	42	3.581
BPAR6630	1231	1259	1286	66	30	2.61	49	4.407
BPAR6636	1348	1398	1452	66	36	2.61	57	5.234
BPAR6642	1489	1540	1594	66	42	2.61	65	6.060
BPAR6648	1601	1650	1704	66	48	2.61	72	6.887
BPAR6654	1718	1769	1821	66	54	2.61	79	7.713
BPAR6660	1825	1877	1930	66	60	2.61	86	8.539
BPAR7418	1103	1135	1169	74	18	2.61	38	3.079
BPAR7424	1194	1248	1300	74	24	2.61	45	4.002
BPAR7430	1306	1356	1413	74	30	2.61	53	4.926
BPAR7436	1429	1489	1489	74	36	2.61	60	5.850
BPAR7442	1440	1624	1677	74	42	2.61	68	6.773
BPAR7448	1688	1774	1867	74	48	2.61	75	7.697
BPAR7454	1807	1856	1909	74	54	2.61	82	8.620
BPAR7460	1926	1976	2030	74	60	2.61	89	9.544
BPAR8218	1153	1187	1227	82	18	2.61	41	3.403
BPAR8224	1256	1302	1353	82	24	2.61	49	4.424
BPAR8230	1376	1424	1475	82	30	2.61	57	5.444
BPAR8236	1505	1593	1688	82	36	2.61	65	6.465
BPAR8242	1658	1760	1866	82	42	2.61	74	7.486
BPAR8248	1781	1883	1990	82	48	2.61	82	8.507
BPAR8254	1907	2009	2117	82	54	2.61	90	9.528
BPAR8260	2034	2133	2241	82	60	2.61	98	10.549

**BPFA • Acoustical Fabric Panel**

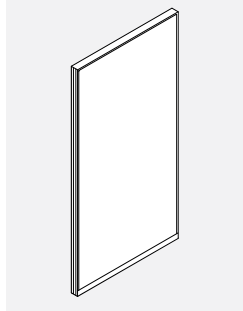

- Complete fabric panel without raceway.
- Acoustical rating of .80 NRC and 26 STC.
- Center septum overlaid on either side with 1 1/8" Mineral board, non tackable.
- OPT\* = Laminate or Whiteboard.

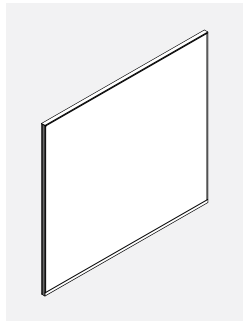

72" Wide

PRODUCT CODE	PRICE			SIZE/INCHES			WEIGHT VOL	
	GR 1	GR 2	OPT*	H	W	D	LBS	FT <sup>3</sup>
BPFA2918	323	349	374	29	18	2.61	15	1.256
BPFA2924	350	378	408	29	24	2.61	17	1.633
BPFA2930	373	398	425	29	30	2.61	19	2.009
BPFA2936	401	449	504	29	36	2.61	21	2.386
BPFA2942	425	476	529	29	42	2.61	23	2.763
BPFA2948	448	498	554	29	48	2.61	25	3.139
BPFA2954	475	525	579	29	54	2.61	27	3.513
BPFA2960	498	550	603	29	60	2.61	29	3.893
BPFA2966	644	698	754	29	66	2.61	36	4.332
BPFA2972	790	843	-	29	72	2.61	42	4.770
BPFA4218	425	449	477	42	18	2.61	18	1.782
BPFA4224	452	504	557	42	24	2.61	21	2.317
BPFA4230	477	528	582	42	30	2.61	24	2.852
BPFA4236	506	567	637	42	36	2.61	27	3.387
BPFA4242	531	595	663	42	42	2.61	30	3.921
BPFA4248	561	624	692	42	48	2.61	33	4.456
BPFA4254	587	647	717	42	54	2.61	36	4.991
BPFA4260	616	678	745	42	60	2.61	39	5.525
BPFA4266	875	981	1095	42	66	2.61	47	6.148
BPFA4272	1134	1241	-	42	72	2.61	54	6.770
BPFA5018	479	504	530	50	18	2.61	22	2.106
BPFA5024	509	546	588	50	24	2.61	25	2.738
BPFA5030	538	576	619	50	30	2.61	28	3.370
BPFA5036	566	642	723	50	36	2.61	31	4.002
BPFA5042	597	671	751	50	42	2.61	34	4.634
BPFA5048	624	700	781	50	48	2.61	38	5.266
BPFA5054	654	729	810	50	54	2.61	41	5.898
BPFA5060	682	757	840	50	60	2.61	43	6.530
BPFA5066	944	1049	1164	50	66	2.61	53	7.300
BPFA5072	1207	1311	-	50	72	2.61	62	8.000
BPFA5418	534	558	587	54	18	2.61	23	2.250
BPFA5424	565	601	643	54	24	2.61	26	2.960
BPFA5430	597	635	676	54	30	2.61	30	3.689
BPFA5436	625	701	782	54	36	2.61	34	4.318
BPFA5442	657	733	813	54	42	2.61	38	4.934
BPFA5448	686	762	842	54	48	2.61	41	5.666
BPFA5454	718	794	874	54	54	2.61	43	6.398
BPFA5460	750	826	907	54	60	2.61	46	7.035

**BPFA • Acoustical Fabric Panel ... Continued**

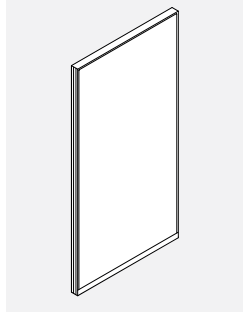

- Complete fabric panel without raceway.
- Acoustical rating of .80 NRC and 26 STC.
- Center septum overlaid on either side with 1 1/8" Mineral board, non tackable.
- OPT\* = Laminate or Whiteboard.

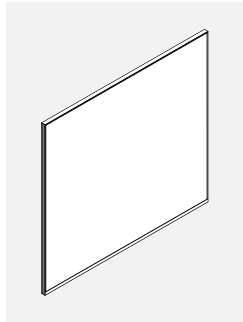

72" Wide

PRODUCT CODE	PRICE			SIZE/INCHES			WEIGHT VOL	
	GR1	GR2	OPT*	H	W	D	LBS	FT <sup>3</sup>
BPFA5818	534	571	612	58	18	2.61	24	2.431
BPFA5824	565	617	669	58	24	2.61	27	3.160
BPFA5830	597	646	701	58	30	2.61	31	3.889
BPFA5836	625	711	808	58	36	2.61	35	4.618
BPFA5842	657	744	840	58	42	2.61	39	5.347
BPFA5848	686	776	869	58	48	2.61	42	6.076
BPFA5854	718	806	901	58	54	2.61	46	6.806
BPFA5860	750	840	935	58	60	2.61	50	7.535
BPFA6618	583	621	662	66	18	2.61	26	2.755
BPFA6624	619	668	722	66	24	2.61	29	3.581
BPFA6630	652	702	754	66	30	2.61	34	4.407
BPFA6636	685	787	895	66	36	2.61	39	5.234
BPFA6642	719	820	928	66	42	2.61	43	6.060
BPFA6648	752	854	964	66	48	2.61	47	6.887
BPFA6654	788	891	997	66	54	2.61	51	7.713
BPFA6660	820	922	1029	66	60	2.61	55	8.539
BPFA7418	637	674	714	74	18	2.61	28	3.079
BPFA7424	676	739	806	74	24	2.61	32	4.002
BPFA7430	709	775	842	74	30	2.61	37	4.926
BPFA7436	746	859	981	74	36	2.61	42	5.850
BPFA7442	783	896	1016	74	42	2.61	47	6.773
BPFA7448	817	930	1053	74	48	2.61	51	7.697
BPFA7454	854	967	1089	74	54	2.61	55	8.620
BPFA7460	892	1004	1127	74	60	2.61	60	9.544
BPFA8218	692	743	794	82	18	2.61	30	3.403
BPFA8224	729	790	859	82	24	2.61	35	4.424
BPFA8230	767	830	898	82	30	2.61	40	5.444
BPFA8236	805	930	1065	82	36	2.61	45	6.465
BPFA8242	842	968	1102	82	42	2.61	50	7.486
BPFA8248	884	1010	1143	82	48	2.61	55	8.507
BPFA8254	924	1052	1184	82	54	2.61	60	9.528
BPFA8260	964	1090	1224	82	60	2.61	65	10.549

**BPFG • Glazed Panel**

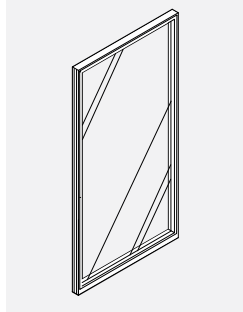

- Full-height glazing provides visual accessibility.
- Glazing is replaceable on site.

PRODUCT CODE	PRICE	SIZE/INCHES			WEIGHT VOL	
		H	W	D	LBS	FT <sup>3</sup>
BPFG5824	745	58	24	2.61	21	3.160
BPFG5830	817	58	30	2.61	24	3.889
BPFG5836	894	58	36	2.61	27	4.618
BPFG5842	965	58	42	2.61	30	5.347
BPFG5848	1037	58	48	2.61	33	6.076
BPFG6624	896	66	24	2.61	25	3.581
BPFG6630	971	66	30	2.61	28	4.407
BPFG6636	1049	66	36	2.61	31	5.234
BPFG6642	1127	66	42	2.61	34	6.060
BPFG6648	1203	66	48	2.61	37	6.887
BPFG7424	938	74	24	2.61	28	4.002
BPFG7430	1016	74	30	2.61	31	4.926
BPFG7436	1100	74	36	2.61	34	5.850
BPFG7442	1181	74	42	2.61	37	6.773
BPFG7448	1261	74	48	2.61	40	7.697
BPFG8224	1024	82	24	2.61	31	4.424
BPFG8230	1113	82	30	2.61	34	5.444
BPFG8236	1203	82	36	2.61	37	6.465
BPFG8242	1295	82	42	2.61	40	7.486
BPFG8248	1382	82	48	2.61	43	8.507

**BPOF • Fabric Over Panel**

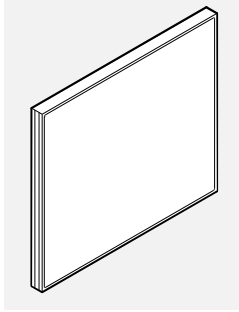

- Attaches to top of a panel to create floor-to-ceiling wall.
- Center septum overlaid on either side with 1 1/8" Mineral board.
- Non-slotted.
- Factory installed PVC strip attaches and aligns over panel to top of base panel.
- PVC strip runs entire width eliminating light seepage.
- For custom heights and widths, please order size required and price as next size up. Example: 26" high, 35" wide, order BPOF2635 at \$359 Grade 1.
- Custom heights over 42" must be quoted separately.
- Overpanels can be stacked on any panel. Example: BPOF2418 stacked on BPRA4218 to give an overall height of 66".
- When stacking on 29" or 37" high B1 panels, custom height required, please contact customer service.
- Exact height should be specified when ordering, with allowance of at least 1" of free space between over panel and ceiling to accommodate height variations in ceiling and floor. Runs of over panels should be captured at either end with full height posts, wall adapters, taller panels, and/or vertical trims.
- Minimum height of 6".
- OPT\* = Laminate or Whiteboard.

PRODUCT CODE	PRICE			SIZE/INCHES			WEIGHT VOL	
	GR 1	GR 2	OPT*	H	W	D	LBS	FT³
BPOF0818	163	174	191	8	18	2.61	6	0.351
BPOF0824	188	212	238	8	24	2.61	6	0.468
BPOF0830	222	249	275	8	30	2.61	8	0.730
BPOF0836	260	286	312	8	36	2.61	10	0.912
BPOF0842	287	312	339	8	42	2.61	10	0.912
BPOF0848	323	349	374	8	48	2.61	12	1.094
BPOF0854	361	384	411	8	54	2.61	12	1.094
BPOF0860	385	411	438	8	60	2.61	14	1.277
BPOF0866	525	579	636	8	66	2.61	17	1.549
BPOF0872	665	719	776	08	72	2.61	20	1.820
BPOF1618	215	227	244	16	18	2.61	8	0.730
BPOF1624	245	269	296	16	24	2.61	8	0.730
BPOF1630	280	304	331	16	30	2.61	10	0.912
BPOF1636	314	340	367	16	36	2.61	12	1.094
BPOF1642	341	367	394	16	42	2.61	12	1.094
BPOF1648	377	405	428	16	48	2.61	14	1.277
BPOF1654	414	438	466	16	54	2.61	14	1.277
BPOF1660	439	466	491	16	60	2.61	15	1.368
BPOF1666	595	648	705	16	66	2.61	20	1.774
BPOF1672	750	804	859	16	72	2.61	24	2.180
BPOF2418	295	306	322	24	18	2.61	12	1.094
BPOF2424	320	344	372	24	24	2.61	14	1.422
BPOF2430	345	372	398	24	30	2.61	17	1.750
BPOF2436	371	408	448	24	36	2.61	18	2.078
BPOF2442	395	433	475	24	42	2.61	21	2.406
BPOF2448	422	460	501	24	48	2.61	22	2.734
BPOF2454	444	471	496	24	54	2.61	24	3.063
BPOF2460	473	509	550	24	60	2.61	27	3.391
BPOF2466	635	687	744	24	66	2.61	32	3.766
BPOF2472	794	848	903	24	72	2.61	36	4.140
BPOF3718	338	363	389	37	18	2.61	17	1.580
BPOF3724	366	392	419	37	24	2.61	19	2.054
BPOF3730	393	431	473	37	30	2.61	22	2.528
BPOF3736	420	481	550	37	36	2.61	24	3.006
BPOF3742	444	508	576	37	42	2.61	28	3.476
BPOF3748	474	535	603	37	48	2.61	30	3.950
BPOF3754	498	562	631	37	54	2.61	32	4.424
BPOF3760	528	590	659	37	60	2.61	34	4.898
BPOF3766	744	849	962	37	66	2.61	41	5.449
BPOF3772	960	1065	-	37	72	2.61	48	6.000
BPOF4218	425	449	477	42	18	2.61	18	1.780
BPOF4224	452	504	557	42	24	2.61	21	2.310
BPOF4230	477	528	582	42	30	2.61	24	2.850
BPOF4236	506	567	637	42	36	2.61	27	3.390
BPOF4242	531	595	663	42	42	2.61	30	3.920
BPOF4248	561	624	697	42	48	2.61	33	4.460
BPOF4254	587	647	717	42	54	2.61	36	4.990
BPOF4260	616	678	745	42	60	2.61	39	5.250
BPOF4266	867	971	1085	42	66	2.61	47	6.015
BPOF4272	1118	1223	1337	42	72	2.61	54	6.780

**BPOG • Glazed Over Panel**

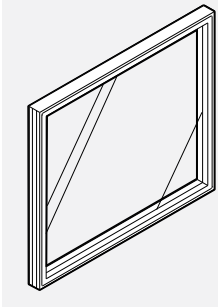

- Attaches to top of a panel to create floor-to-ceiling wall.
- Non-slotted.
- Factory installed PVC strip attaches and aligns over panel to top of base panel.
- PVC strip runs entire width eliminating light seepage.
- For custom heights and widths, order size required and price as next size up. Example: 26" high, 35" wide, order BPOG2635 at \$571 in acrylic.
- Custom heights over 42" must be quoted separately.
- Over panels can be stacked on any panel. Example: BPOG2418 stacked on BPRA4218 to give an overall height of 66".
- When stacking on 29" or 37" high B1 panels, custom height required, please contact customer service.
- Exact height should be specified when ordering, with allowance of at least 1" of free space between over panel and ceiling to accommodate height variations in ceiling and floor. Runs of over panels should be captured at either end with full height posts, wall adapters, taller panels, and/or vertical trims.
- Minimum height of 6".

PRODUCT CODE	PRICE	SIZE/INCHES			WEIGHT VOL	
		H	W	D	LBS	FT <sup>3</sup>
BPOG0818	108	8	18	2.61	6	0.351
BPOG0824	135	8	24	2.61	6	0.468
BPOG0830	163	8	30	2.61	8	0.730
BPOG0836	188	8	36	2.61	10	0.912
BPOG0842	215	8	42	2.61	10	0.912
BPOG0848	245	8	48	2.61	12	1.094
BPOG0854	271	8	54	2.61	12	1.094
BPOG0860	298	8	60	2.61	14	1.277
BPOG0866	394	8	66	2.61	17	1.549
BPOG0872	491	8	72	2.61	20	1.820
BPOG1618	172	16	18	2.61	8	0.730
BPOG1624	209	16	24	2.61	8	0.730
BPOG1630	245	16	30	2.61	10	0.912
BPOG1636	287	16	36	2.61	12	1.094
BPOG1642	314	16	42	2.61	12	1.094
BPOG1648	351	16	48	2.61	14	1.277
BPOG1654	385	16	54	2.61	14	1.277
BPOG1660	423	16	60	2.61	15	1.368
BPOG1666	550	16	66	2.61	20	1.774
BPOG1672	676	16	72	2.61	24	2.180
BPOG2418	309	24	18	2.61	12	1.094
BPOG2424	345	24	24	2.61	14	1.422
BPOG2430	383	24	30	2.61	17	1.750
BPOG2436	422	24	36	2.61	18	2.078
BPOG2442	460	24	42	2.61	21	2.406
BPOG2448	496	24	48	2.61	22	2.734
BPOG2454	534	24	54	2.61	24	3.063
BPOG2460	572	24	60	2.61	27	3.391
BPOG2466	786	24	66	2.61	32	3.766
BPOG2472	998	24	72	2.61	36	4.140
BPOG3718	439	37	18	2.61	17	1.580
BPOG3724	482	37	24	2.61	19	2.054
BPOG3730	528	37	30	2.61	22	2.528
BPOG3736	571	37	36	2.61	24	3.006
BPOG3742	616	37	42	2.61	28	3.476
BPOG3748	657	37	48	2.61	30	3.950
BPOG3754	698	37	54	2.61	32	4.424
BPOG3760	745	37	60	2.61	34	4.898
BPOG3766	968	37	66	2.61	41	5.449
BPOG3772	1192	37	72	2.61	48	6.000
BPOG4218	468	42	18	2.61	18	1.780
BPOG4224	513	42	24	2.61	21	2.310
BPOG4230	561	42	30	2.61	24	2.850
BPOG4236	604	42	36	2.61	27	3.390
BPOG4242	657	42	42	2.61	30	3.920
BPOG4248	698	42	48	2.61	33	4.460
BPOG4254	745	42	54	2.61	36	4.990
BPOG4260	789	42	60	2.61	39	5.250
BPOG4266	1035	42	66	2.61	47	6.015
BPOG4272	1278	42	72	2.61	54	6.780



**BAPAS • Glass Over Panel With Round Pucks for Boulevard 1**

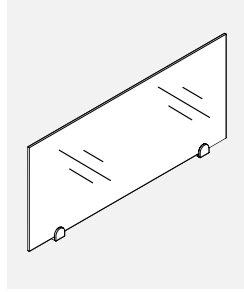

- Glass Over Panel creates division.
- Glass Over Panel with no frame sits on top of a Boulevard 1 Panel with clamps that are secured to the top of the panel.
- Tempered glass is 16" high.
- Custom sizes available, contact your Customer Service Representative.
- For application where the over panel is sandwiched between two taller panels, please request a special as the glass will not fit due to trims.

PRODUCT CODE	PRICE		SIZE/INCHES			WEIGHT VOL	
	CLR	FRST	H	W	D	LBS	FT <sup>3</sup>
BAPAS0824	212	241	8	24	1.3	4	0.22
BAPAS0830	231	259	8	30	1.3	5	0.30
BAPAS0836	249	279	8	36	1.3	6	0.37
BAPAS0842	263	299	8	42	1.3	7	0.43
BAPAS0848	271	317	8	48	1.3	8	0.48
BAPAS1624	212	234	16	24	1.3	8	0.44
BAPAS1630	231	259	16	30	1.3	10	0.59
BAPAS1636	249	279	16	36	1.3	12	0.73
BAPAS1642	263	299	16	42	1.3	14	0.85
BAPAS1648	271	317	16	48	1.3	16	0.96

**BAPASS • Glass Over Panel With Square Pucks for Boulevard 1**

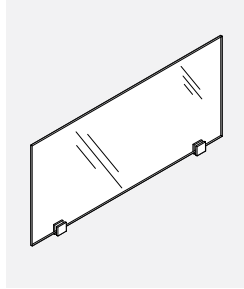

- Glass Over Panel creates division.
- Glass Over Panel with no frame sits on top of a Boulevard 1 Panel with clamps that are secured to the top of the panel.
- Tempered glass is 16" high.
- Custom sizes available, contact your Customer Service Representative.
- For application where the over panel is sandwiched between two taller panels, please request a special as the glass will not fit due to trims.

PRODUCT CODE	PRICE		SIZE/INCHES			WEIGHT VOL	
	CLR	FRST	H	W	D	LBS	FT <sup>3</sup>
BAPASS0824	216	238	8	24	1.3	4	0.22
BAPASS0830	237	263	8	30	1.3	5	0.30
BAPASS0836	253	284	8	36	1.3	6	0.37
BAPASS0842	268	304	8	42	1.3	7	0.43
BAPASS0848	277	320	8	48	1.3	8	0.48
BAPASS1624	216	238	16	24	1.3	8	0.44
BAPASS1630	237	263	16	30	1.3	10	0.59
BAPASS1636	253	284	16	36	1.3	12	0.73
BAPASS1642	268	304	16	42	1.3	14	0.85
BAPASS1648	277	320	16	48	1.3	16	0.96

**BAPAST • Felt Over Panel With Round Pucks for Boulevard 1**

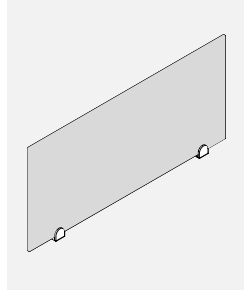

- Felt Over Panel creates division.
- Felt Over Panel with no frame sits on top of a Boulevard 1 panel with round clamps that are secured to the top of the panel.
- Felt panel is 8" and 16" high.
- 9 mm different colors. Please specify color.
- For application where the over panel is sandwiched between two taller panels, please request a special as the glass will not fit due to trims.

PRODUCT CODE	PRICE		SIZE/INCHES			WEIGHT VOL	
	CLR	FRST	H	W	D	LBS	FT <sup>3</sup>
BAPAST0824	137		8	22.7	1.13	1.0	0.11
BAPAST0830	149		8	28.7	1.13	1.1	0.14
BAPAST0836	160		8	34.7	1.13	1.2	0.17
BAPAST0842	173		8	40.7	1.13	1.3	0.20
BAPAST0848	187		8	46.7	1.13	1.4	0.23
BAPAST1624	177		16	22.7	1.13	1.4	0.23
BAPAST1630	200		16	28.7	1.13	1.5	0.29
BAPAST1636	228		16	34.7	1.13	1.7	0.35
BAPAST1642	249		16	40.7	1.13	1.9	0.42
BAPAST1648	265		16	46.7	1.13	2.0	0.48

**BAPASST • Felt Over Panel With Square Pucks for Boulevard 1**

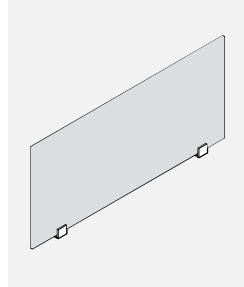

- Felt Over Panel creates division.
- Felt Over Panel with no frame sits on top of a Boulevard 1 panel with round clamps that are secured to the top of the panel.
- Felt panel is 8" and 16" high.
- 9 mm different colors. Please specify color.
- For application where the over panel is sandwiched between two taller panels, please request a special as the glass will not fit due to trims.

PRODUCT CODE	PRICE		SIZE/INCHES			WEIGHT VOL	
	CLR	FRST	H	W	D	LBS	FT <sup>3</sup>
BAPASST0824	137		8	22.7	1.13	1.0	0.11
BAPASST0830	149		8	28.7	1.13	1.1	0.14
BAPASST0836	160		8	34.7	1.13	1.2	0.17
BAPASST0842	173		8	40.7	1.13	1.3	0.20
BAPASST0848	187		8	46.7	1.13	1.4	0.23
BAPASST1624	177		16	22.7	1.13	1.4	0.23
BAPASST1630	200		16	28.7	1.13	1.5	0.29
BAPASST1636	228		16	34.7	1.13	1.7	0.35
BAPASST1642	249		16	40.7	1.13	1.9	0.42
BAPASST1648	265		16	46.7	1.13	2.0	0.48

**BPDS • Solid Door Panel**

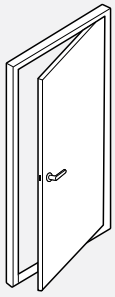

- Aluminum frame with high pressure laminate.
- 1 3/8" thick hollow core door.
- Actual door size:
  - 80" x 32 1/2" in 82" x 36" frame
  - 80" x 38 1/2" in 82" x 42" frame
- 42" wide Door Panel permits wheelchair accessibility.
- No hang-on capabilities.
- Non slotted frame.
- 180 degree swing.
- Specify Door Knob (DL01) or Door Lever (DL02).
- Lock standard.
- Handedness can be changed on site.
- Please specify Right hand (R) or Left hand (L) hung.

PRODUCT CODE	PRICE HP	SIZE/INCHES			WEIGHT VOL	
		H	W	D	LBS	FT <sup>3</sup>
BPDS8236R	2078	82	36	2.61	61	6.465
BPDS8242R	2263	82	42	2.61	68	7.486
BPDS8236L	2078	82	36	2.61	61	6.465
BPDS8242L	2263	82	42	2.61	68	7.486

**Door Hanging Directions**



**Door Handle Option**

Door Knob - DL01  
• Lock Standard



Door Lever - DL02(Default)

Lock Standard  
Lever complies with all accessibility standards



**BPDH • Half-Glazed Door Panel**

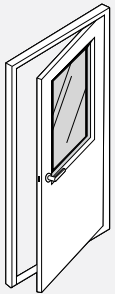

- Aluminum frame with high pressure laminate door and window.
- 1 3/8" thick hollow core door.
- Actual door size:
  - 80" x 32 1/2" in 82" x 36" frame
  - 80" x 38 1/2" in 82" x 42" frame
- 42" wide Door Panel permits wheelchair accessibility.
- No hang-on capabilities.
- 180 degree swing.
- Specify Door Knob (DL01) or Door Lever (DL02).
- Lock standard.
- Handedness can be changed on site.
- Please specify Right hand (R) or Left hand (L) hung.

PRODUCT CODE	PRICE HP	SIZE/INCHES			WEIGHT VOL	
		H	W	D	LBS	FT <sup>3</sup>
BPDH8236R	2573	82	36	2.61	53	6.465
BPDH8242R	2814	82	42	2.61	59	7.486
BPDH8236L	2573	82	36	2.61	53	6.465
BPDH8242L	2814	82	42	2.61	59	7.486

**Door Hanging Directions**

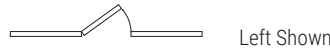

**Door Handle Option**

Door Knob - DL01  
• Lock Standard



Door Lever - DL02(Default)

Lock Standard  
Lever complies with all accessibility standards



**BPDG • Solid-Glazed Door Panel**

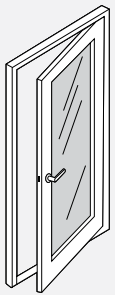

- Aluminum frame with either high pressure laminate door and window.
- 1 3/8" thick hollow core door.
- Actual door size:
  - 80" x 32 1/2" in 82" x 36" frame
  - 80" x 38 1/2" in 82" x 42" frame
- 42" wide Door Panel permits wheelchair accessibility.
- No hang-on capabilities.
- 180 degree swing.
- Specify Door Knob (DL01) or Door Lever (DL02).
- Lock standard.
- Handedness can be changed on site.
- Please specify Right hand (R) or Left hand (L) hung.
- Laminate frame is 5" thick on sides and 4" at top and bottom.

PRODUCT CODE	PRICE HP	SIZE/INCHES			WEIGHT VOL	
		H	W	D	LBS	FT <sup>3</sup>
BPDG8236R	4120	82	36	2.61	53	6.465
BPDG8242R	4507	82	42	2.61	59	7.486
BPDG8236L	4120	82	36	2.61	53	6.465
BPDG8242L	4507	82	42	2.61	59	7.486

**Door Hanging Directions**

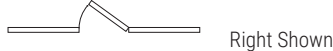

**Door Handle Option**

Door Knob - DL01  
• Lock Standard



Door Lever - DL02(Default)

Lock Standard  
Lever complies with all accessibility standards



**BPDSL • Privacy Screen**

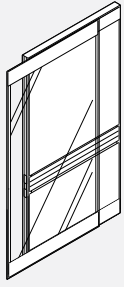

- Provides territorial privacy in an open plan environment.
  - Lightweight, panel-mounted sliding partition.
  - Consists of translucent textured polycarbonate.
  - Must be mounted to a straight panel of the same size.
  - The face of the Privacy Screen sits 3" away from the face of the panel to which it is attached.
  - Cable lay-in modules, wood trim and non-load bearing panels may be applied to the top of a panel to which the screen is attached, but not the screen itself.
  - When open, the screen may interfere with access doors that open on the outside of an adjacent panel.
  - Must specify left or right for the direction in which the door will slide once installed.
  - Caps located on the end of the frame default to the panel frame color.
  - All hardware included.
  - Can be mounted on Boulevard 1 or Boulevard System 3 panels of the same width as the Privacy Screen.
- Note: Specify left or right for the direction in which the door will slide as per examples above.

PRODUCT CODE	PRICE	SIZE / INCHES			WEIGHT VOL	
		H	W	D	LBS	FT <sup>3</sup>
BPDSL6636R	2074	66	36	2.61	35	5.98
BPDSL6642R	2234	66	42	2.61	42	6.93
BPDSL8136R	2489	81	36	2.61	43	7.30
BPDSL8142R	2672	81	42	2.61	50	8.45
BPDSL6636L	2074	66	36	2.61	35	5.98
BPDSL6642L	2234	66	42	2.61	42	6.93
BPDSL8136L	2489	81	36	2.61	43	7.30
BPDSL8142L	2672	81	42	2.61	50	8.45

Left Hang Option

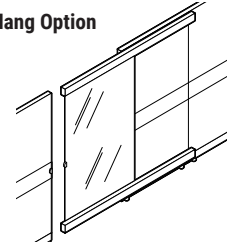

Right Hang Hung

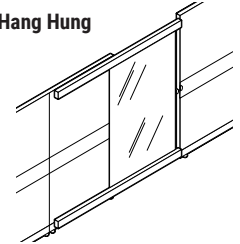

**BPDSLLOCK • Privacy Screen Lock**

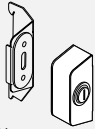

Left Hand Shown

- Lock bracket attaches to Privacy Screen with screws
- Includes strike plate bracket which attaches to slots in connector.
- Lock included.
- Available in tungsten only.
- Requires on site installation, drilling into the Privacy Screen aluminum frame.

PRODUCT CODE	PRICE	SIZE / INCHES			WEIGHT VOL	
		H	W	D	LBS	FT <sup>3</sup>
BPDSLLOCKR	320	2.65	1.2	0.9	1	0.2
BPDSLLOCKL	320	2.65	1.2	0.9	1	0.2

**BPXCF • Ceiling Filler**

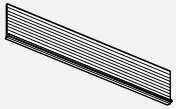

- Durable PVC designed to seal a gap between ceiling and over panel.
- Available in lengths of 124" to be pressed into over panel's horizontal wing profile.
- Can be applied during installation or retrofitted later.
- For use only with Boulevard 1 panels.

PRODUCT CODE	PRICE	SIZE/INCHES			WEIGHT VOL	
		H	W	D	LBS	FT <sup>3</sup>
BPXCF124	59	3.25	124	0.125	1	1.2

**BHP • 90 Degree Post**

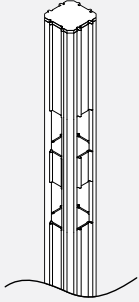

- Enables connection for multiple panel runs such as 90 degree, 3 way and 4 way.
- Includes 2 "Capture Strip" panel connectors, 4 end strips, 4 pairs of raceway end caps, and 1 post cap.
- Posts are designed to accept the following:
  - 75 cables 5.6 mm (0.220") diameter
  - 60 cables 5.6 mm (0.220") diameter with 1 powerfeed
  - 45 cables 5.6 mm (0.220") diameter with 2 powerfeeds

PRODUCT CODE	PRICE	SIZE/INCHES			WEIGHT VOL	
		H	W	D	LBS	FT <sup>3</sup>
BHP029	71	29	2.61	2.61	4	0.154
BHP037	112	37	2.61	2.61	5	0.195
BHP042	123	42	2.61	2.61	5	0.221
BHP050	139	50	2.61	2.61	6	0.263
BHP054	153	54	2.61	2.61	6	0.284
BHP058	153	58	2.61	2.61	7	0.305
BHP066	166	66	2.61	2.61	8	0.346
BHP074	179	74	2.61	2.61	9	0.388
BHP082	194	82	2.61	2.61	9	0.430
BHP106	230	106	2.61	2.61	12	0.560
BHP119	250	119	2.61	2.61	13	0.622

**BHP45 • 45 Degree Post**

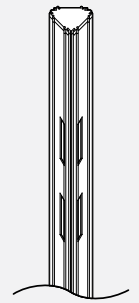

- Enables connection for two panels at 45 degrees.
- Includes 2 "Capture Strip" panel connectors, 4 end strips, 2 pairs of raceway end caps, and 1 post cap.
- 45 degree post does not accept PVC or Wood End Trim.
- No power infeed/post extension capabilities.
- Posts are designed to accept 30 cables 5.6 mm (0.220") diameter

PRODUCT CODE	PRICE	SIZE/INCHES			WEIGHT VOL	
		H	W	D	LBS	FT <sup>3</sup>
BHP4529	71	29	2.61	2.61	4	0.154
BHP4537	112	37	2.61	2.61	5	0.195
BHP4542	123	42	2.61	2.61	5	0.221
BHP4550	139	50	2.61	2.61	6	0.263
BHP4554	153	54	2.61	2.61	6	0.284
BHP4558	153	58	2.61	2.61	7	0.305
BHP4566	166	66	2.61	2.61	8	0.346
BHP4574	179	74	2.61	2.61	9	0.388
BHP4582	194	82	2.61	2.61	9	0.430
BHP45106	230	106	2.61	2.61	12	0.560
BHP45119	250	119	2.61	2.61	13	0.622

**BHP60 • 60 Degree Post**

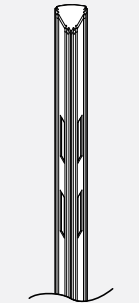

- Enables connection for multiple panel runs such as 120 degrees and 3 way.
- Includes 2 "Capture Strip" panel connectors, 4 end strips, 3 pair of raceway end caps, and 1 post cap.
- No power infeed/post extension capabilities.

PRODUCT CODE	PRICE	SIZE/INCHES			WEIGHT VOL	
		H	W	D	LBS	FT <sup>3</sup>
BHP6029	71	29	2.61	2.61	4	0.154
BHP6037	112	37	2.61	2.61	5	0.195
BHP6042	123	42	2.61	2.61	5	0.221
BHP6050	139	50	2.61	2.61	6	0.263
BHP6054	153	54	2.61	2.61	6	0.284
BHP6058	153	58	2.61	2.61	7	0.305
BHP6066	166	66	2.61	2.61	8	0.346
BHP6074	179	74	2.61	2.61	9	0.388
BHP6082	194	82	2.61	2.61	9	0.430
BHP60106	230	106	2.61	2.61	12	0.560
BHP60119	250	119	2.61	2.61	13	0.622

**BHWA • Wall Adapter**

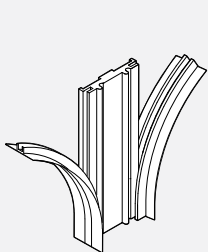

- Starts a run of panels off an existing wall.
- Includes 2 "Capture Strip" panel connectors and 1 pair of raceway end caps.
- Mounting hardware not included. The mounting hardware selected must be based on the wall or wall stud material.
- Wall adapter adds 5/16" to a panel run.

PRODUCT CODE	PRICE	SIZE/INCHES			WEIGHT VOL	
		H	W	D	LBS	FT <sup>3</sup>
BHWA029	47	29	2.61	0.375	4	0.01
BHWA037	49	37	2.61	0.375	5	0.013
BHWA042	56	42	2.61	0.375	5	0.015
BHWA050	64	50	2.61	0.375	6	0.018
BHWA054	68	54	2.61	0.375	6	0.020
BHWA058	69	58	2.61	0.375	7	0.021
BHWA066	72	66	2.61	0.375	8	0.024
BHWA074	76	74	2.61	0.375	9	0.027
BHWA082	82	82	2.61	0.375	9	0.030
BHWA106	99	106	2.61	0.375	12	0.039
BHWA119	108	119	2.61	0.375	13	0.043

**BHWASL • Adapter Sleeve**



- Wall Adapter Sleeve is attached to the building to provide flexible support to a panel run.
- As opposed to the BHWA wall adapter, which connects to the panels securely to a wall, B1 and B3 Boulevard panels rest inside the vertical "U" channel, providing up to 3.5" of flexible adjustment.
- For panel runs taller than 66" order two Wall Adapter Sleeve and either have them cut short on site below the ceiling, or cut a rectangular hole in the ceiling tile. Rectangular slots in the Channels correspond to 66", 58", 50" and 42" high B1 and B3 panels.
- Powder coated steel; specify metal finish.
- Note: the Wall Adapter Sleeve provides flexible, connection, blocks vertical 1" increment clots and cannot, therefore, be used to support overheads and worksurfaces, they must be supported by perpendicular panels, c-legs or gables.
- Note: No fasteners are provided with the Wall Adapter Sleeve. Select the appropriate fasteners according to a structurally wall type.
- Cannot be used to support a door or panel and cannot be used with laminate, airflow or metal skin panels.

PRODUCT CODE	PRICE	SIZE/INCHES			WEIGHT VOL	
		H	W	D	LBS	FT <sup>3</sup>
BHWASL42	201	34.7	4	2	2.5	0.161
BHWASL50	216	42.7	4	2	3.6	0.198
BHWASL54	223	42.7	4	2	4.2	0.220
BHWASL58	231	52.7	4	2	5.1	0.244
BHWASL66	249	58.7	4	2	6.0	0.272

**BHHF • High-Profile Foot**

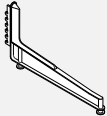

- Provides added support to panel under load.
- Adjustable glides included.
- Made of cast aluminum and cold rolled steel.
- Cannot be used with System 3 Panels

PRODUCT CODE	PRICE	SIZE/INCHES			WEIGHT VOL	
		H	W	D	LBS	FT <sup>3</sup>
BHHF01	314	9	1	18.375	4	0.130

**BHLF • Low-Profile Foot**

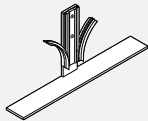

- Stabilizes a run of panels.
- Attaches with supplied connectors to an end of a panel.
- Made of cold rolled steel.
- Cannot be used with System 3 Panels

PRODUCT CODE	PRICE	SIZE/INCHES			WEIGHT VOL	
		H	W	D	LBS	FT <sup>3</sup>
BHLF01	43	6	9	2.5	7	0.230

**BHPA • Panel-to-Panel Adapter**

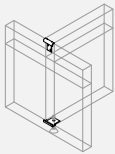

- Enables mid panel, off-module connection.
- Slim profile.
- Formed steel construction.
- Permanent clamps fit around base channel and fits to top rail.
- Priced as a complete kit.
- Designed for use with Boulevard 1 panels of the same height only.
- Not to be specified on panel seam or with over panels.
- Not to be used on the panel seam, with over panels or laminate and metal faced panels.

PRODUCT CODE	PRICE	SIZE/INCHES			WEIGHT VOL	
		H	W	D	LBS	FT <sup>3</sup>
BHPA02	43	2	2.5	00.0	0.25	0.120

**BHCS • Capture Strip Slot Cover**



- An extruded PVC channel to adjoin two panels or a panel to a post. Runs the full length of the panel on both sides providing a positive connection of the "Knuckle-Loc" design.
- Priced per pair.
- Pliable side membranes cover panel slots.
- Included with panel components.
- Only to be ordered separately if required.

PRODUCT CODE	PRICE	SIZE/INCHES			WEIGHT VOL	
		H			LBS	FT <sup>3</sup>
BHCS29	9	29			0.21	0.09
BHCS37	10	37			0.24	0.11
BHCS42	10	42			0.28	0.13
BHCS50	11	50			0.33	0.15
BHCS54	12	54			0.31	0.17
BHCS58	12	58			0.63	0.19
BHCS66	13	66			0.40	0.19
BHCS74	15	74			0.43	0.20
BHCS82	16	82			0.47	0.20

**BHCE • End Strip Slot Cover**



- End strips with pliable side membrane covers panel slots at end-of-run.
- Priced per pair.
- Included with panel components.
- Only to be ordered separately if required.

PRODUCT CODE	PRICE	SIZE/INCHES			WEIGHT VOL	
		H			LBS	FT <sup>3</sup>
BHCE29	6	29			0.10	0.04
BHCE37	7	37			0.12	0.05
BHCE42	7	42			0.14	0.06
BHCE50	9	50			0.16	0.07
BHCE54	9	54			0.31	0.08
BHCE58	9	58			0.18	0.08
BHCE66	10	66			0.20	0.09
BHCE74	10	74			0.22	0.10
BHCE82	12	82			0.23	0.11

**BHRC • Raceway End Cap**

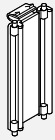

- Provides clean detail at the end of a panel run or post. End caps fit flush into communication and power channel entry.
- Priced per pair.
- Made of injection molded ABS.
- Included with panel components. Only to be ordered separately if required.

PRODUCT CODE	PRICE	SIZE/INCHES			WEIGHT VOL	
		H	W	D	LBS	FT <sup>3</sup>
BHRC02	6	3	2.61	0.5	0.04	0.02

**BVTE • Vertical End PVC Trim**

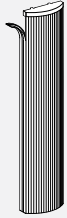

- Provides a rounded finished detail to the end of the panel run, or a post.
- Includes 2 "Capture Strip" panel connectors and 1 injection molded top cap.
- The PVC end trim is designed to snap at the end of the panel or post.
- Site installed.

PRODUCT CODE	PRICE	SIZE/INCHES			WEIGHT VOL	
		H	W	D	LBS	FT <sup>3</sup>
BVTE37	28	37	2.61	0.25	0.41	0.065
BVTE42	31	42	2.61	0.25	0.48	0.074
BVTE50	34	50	2.61	0.25	0.57	0.088
BVTE54	36	54	2.61	0.25	0.62	0.095
BVTE58	38	58	2.61	0.25	0.66	0.102
BVTE66	42	66	2.61	0.25	0.75	0.115
BVTE74	47	74	2.61	0.25	0.84	0.013
BVTE82	55	82	2.61	0.25	0.93	0.143

**BVTS • Vertical Step Down PVC Trim**

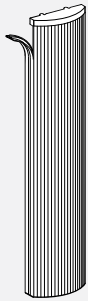

- Provides a rounded finished detail to the end of the panel run where two different height panels are specified.
- Includes 2 "Capture Strip" panel connectors and 1 injection molded top cap.
- The PVC end trim is designed to snap at the end of the panel or post.
- Site installed.
- Please specify panels to be used when ordering a 29" step (BVTS29).

PRODUCT CODE	PRICE	SIZE/INCHES			WEIGHT VOL	
		H	W	D	LBS	FT <sup>3</sup>
BVTS04	10	4	2.61	0.25	0.05	0.010
BVTS08	12	8	2.61	0.25	0.09	0.015
BVTS12	14	12	2.61	0.25	0.12	0.021
BVTS16	26	16	2.61	0.25	0.18	0.029
BVTS20	27	20	2.61	0.25	0.20	0.035
BVTS24	28	24	2.61	0.25	0.27	0.043
BVTS32	31	32	2.61	0.25	0.36	0.056
BVTS38	32	38	2.61	0.25	0.45	0.067
BVTS40	31	40	2.61	0.25	0.45	0.070
BVTS48	32	48	2.61	0.25	0.54	0.084
BVTS56	34	56	2.61	0.25	0.63	0.098

**BVTS • Vertical Step Down PVC Trim for 37"-High Panels**

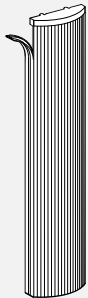

- Provides a finished detail to the end of the panel run that sits next to a 37" high panel. This PVC trim will bridge the distance between the 37" and higher panel.
- Includes 2 "Capture Strip" panel connectors and 1 injection molded top cap.
- The PVC end trim is designed to snap at the end of the panel or post.
- Site installed.
- Please specify panels to be used when ordering a 29" step (BVTS29).

PRODUCT CODE	PRICE	SIZE/INCHES			WEIGHT VOL	
		H	W	D	LBS	FT <sup>3</sup>
BVTS05	10	5	2.61	0.25	0.06	0.015
BVTS13	14	13	2.61	0.25	0.15	0.029
BVTS17	27	17	2.61	0.25	0.15	0.035
BVTS21	28	21	2.61	0.25	0.24	0.043
BVTS29	29	29	2.61	0.25	0.33	0.051
BVTS37	31	37	2.61	0.25	0.41	0.067
BVTS45	32	45	2.61	0.25	0.51	0.084

**BAVTE • Aluminum Vertical End Round Trim**

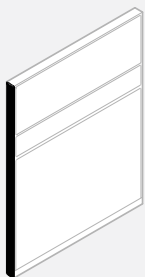

- Provides a finished detail to the end of a panel run.
- Aluminum radiused front section and injection molded top cap.
- Includes 2 "Capture Strip" panel connectors and 1 injection molded top cap.
- The Aluminum End Trim is designed to snap at the end of the panel or post.
- Site installed.
- BAVTE119 cannot ship via courier and must be combined with other product.

PRODUCT CODE	PRICE	SIZE/INCHES			WEIGHT VOL	
		H	W	D	LBS	FT <sup>3</sup>
BAVTE37	75	37	2.61	0.125	1.2	0.03
BAVTE42	85	42	2.61	0.125	1.4	0.03
BAVTE50	99	50	2.61	0.125	1.7	0.04
BAVTE54	108	54	2.61	0.125	1.8	0.04
BAVTE58	115	58	2.61	0.125	1.9	0.04
BAVTE66	131	66	2.61	0.125	2.2	0.05
BAVTE74	155	74	2.61	0.125	2.4	0.05
BAVTE82	163	82	2.61	0.125	2.7	0.06
BAVTE119	236	119	2.61	0.125	3.9	0.08

**BAVTS • Aluminum Vertical End Round Trim - Standard Step Down**

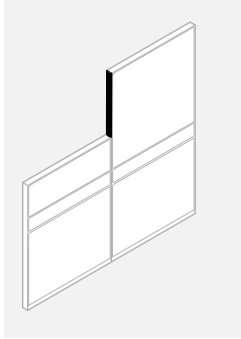

- Provides a finished detail to the end of a panel run where two different height panels are specified.
- Aluminum radiused front section and injection molded top cap.
- Includes 2 "Capture Strip" panel connectors and 1 injection molded top cap.
- The Aluminum End Trim is designed to snap at the end of the panel or post.
- Site installed.
- Specify panels to be used when ordering a 29" step.

PRODUCT CODE	PRICE	SIZE/INCHES			WEIGHT VOL	
		H	W	D	LBS	FT <sup>3</sup>
BAVTS04	21	4	2.61	0.125	0.2	0.01
BAVTS08	26	8	2.61	0.125	0.3	0.02
BAVTS12	39	12	2.61	0.125	0.4	0.02
BAVTS16	39	16	2.61	0.125	0.5	0.03
BAVTS20	39	20	2.61	0.125	0.7	0.04
BAVTS24	59	24	2.61	0.125	0.8	0.04
BAVTS32	75	32	2.61	0.125	1.1	0.06
BAVTS38	88	38	2.61	0.125	1.3	0.07
BAVTS40	93	40	2.61	0.125	1.3	0.07
BAVTS48	112	48	2.61	0.125	1.6	0.08
BAVTS56	126	56	2.61	0.125	1.8	0.10

**BAVTSF • Aluminum Vertical End Round Trim - Step Down for 37"-High Panels**

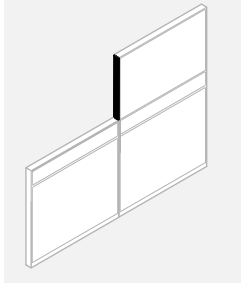

- Provides a finished detail to the end of a panel run adjacent to a 37" high panel.
- Aluminum radiused front section and injection molded top cap.
- Includes 2 "Capture Strip" panel connectors and 1 injection molded top cap.
- The Aluminum End Trim is designed to snap at the end of the panel or post.
- Site installed.

PRODUCT CODE	PRICE	SIZE/INCHES			WEIGHT VOL	
		H	W	D	LBS	FT <sup>3</sup>
BAVTSF05	26	5	2.61	0.125	0.2	0.02
BAVTSF13	39	13	2.61	0.125	0.4	0.03
BAVTSF17	39	17	2.61	0.125	0.6	0.04
BAVTSF21	59	21	2.61	0.125	0.7	0.04
BAVTSF29	75	29	2.61	0.125	1.0	0.05
BAVTSF37	88	37	2.61	0.125	1.2	0.07
BAVTSF45	112	45	2.61	0.125	1.5	0.08

**BARC • Aluminum Raceway Cover**

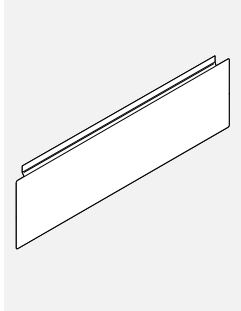

- Offers an alternative to the existing raceway options.
- Cover hinges upward for easy access to power and data/communication terminals.
- Cover may be removed for installation and reconfiguration.
- May not be used with Boulevard System 3 panels.
- Sold as singles.

PRODUCT CODE	PRICE	SIZE/INCHES	INCHES		WEIGHT VOL	
			H	W	D	LBS
BARC06	32	00.0	5	0.125	0.3	0.001
BARC18	36	00.0	17	0.125	1.1	0.001
BARC24	42	00.0	23	0.125	1.4	0.001
BARC30	45	00.0	29	0.125	1.8	0.002
BARC36	49	00.0	35	0.125	2.2	0.002
BARC42	53	00.0	41	0.125	2.5	0.002
BARC48	56	00.0	47	0.125	2.9	0.003
BARC54	64	00.0	53	0.125	3.2	0.003
BARC60	74	00.0	59	0.125	3.7	0.003
BARC66	82	00.0	65	0.125	4.1	0.004
BARC72	86	00.0	72	0.125	4.4	0.004

**Boulevard 1 • Flat Aluminum Trims**

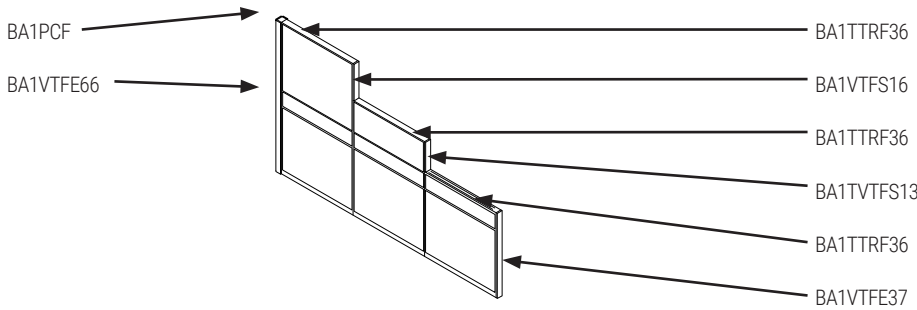

**Flat Aluminum Trims For Boulevard 1:**  
**Designed to use top and vertical trims together on the panel. Specifying vertical trims only will make them too long and will not fit correctly.**  
 You must specify vertical trims as a special if you are NOT using top trims.  
 Post caps BA1PCF must be specified separately when using trims, .

**BA1VTFE • Aluminum Vertical Flat End Trim**

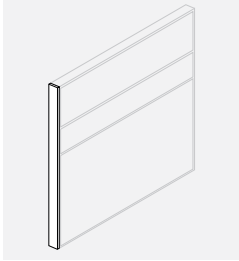

- Provides a finish detail to the end of a panel run.
- Aluminum flat profile with injection molded top cap.
- Included: 2 "capture strip" panel connectors and 1 injection molded top cap.
- The Aluminum End Trim is designed to snap at the end of the panel or post.
- Site installed.
- For use with Aluminum Top Caps.

PRODUCT CODE	PRICE	SIZE/INCHES			WEIGHT VOL	
		H	W	D	LBS	FT <sup>3</sup>
BA1VTFE29	33	29	2.61	0.125	0.7	0.01
BA1VTFE37	53	37	2.61	0.125	1.0	0.02
BA1VTFE42	59	42	2.61	0.125	1.2	0.03
BA1VTFE50	70	50	2.61	0.125	1.5	0.04
BA1VTFE54	76	54	2.61	0.125	1.6	0.04
BA1VTFE58	81	58	2.61	0.125	1.7	0.04
BA1VTFE66	92	66	2.61	0.125	2.0	0.05
BA1VTFE74	103	74	2.61	0.125	2.2	0.05
BA1VTFE82	115	82	2.61	0.125	2.4	0.06

**BA1VTFS • Aluminum Vertical Flat End Trim - Standard Step Down**

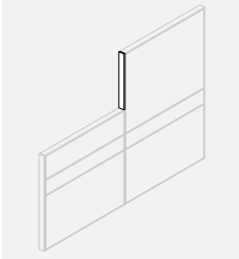

- Provides a finish detail to the end of a panel run where 2 different height panels are specified.
- Aluminum flat profile with injection molded top cap.
- Included: 2 "capture strip" panel connectors and 1 injection molded top cap.
- The aluminum end trim is designed to snap at the end of the panel or post.
- Site installed.
- For use with Aluminum Top Caps.

PRODUCT CODE	PRICE	SIZE/INCHES			WEIGHT VOL	
		H	W	D	LBS	FT <sup>3</sup>
BA1VTFS04	10	4	2.61	0.125	0.1	0.01
BA1VTFS08	16	8	2.61	0.125	0.2	0.01
BA1VTFS12	25	12	2.61	0.125	0.4	0.02
BA1VTFS16	31	16	2.61	0.125	0.6	0.02
BA1VTFS20	39	20	2.61	0.125	0.6	0.03
BA1VTFS24	42	24	2.61	0.125	0.7	0.03
BA1VTFS32	50	32	2.61	0.125	0.9	0.03
BA1VTFS38	56	38	2.61	0.125	1.1	0.03
BA1VTFS40	59	40	2.61	0.125	1.1	0.03
BA1VTFS48	66	48	2.61	0.125	1.3	0.04
BA1VTFS56	76	56	2.61	0.125	1.6	0.05

**BA1VTFS • Aluminum Vertical Flat End Trim - Standard Step Down 37"-High Panels**

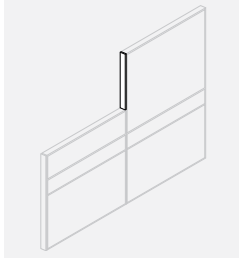

- Provides a finish detail to the end of a panel run adjacent to a 37" high panel.
- Aluminum flat profile with injection molded top cap
- Included 2 "capture strip" panel connectors and 1 injection molded top cap
- The aluminum end trim is designed to snap at the end of the panel or post
- Site installed
- Specify panels to be used when ordering a 29" step down trim.
- For use with Aluminum Top Caps.

PRODUCT CODE	PRICE	SIZE/INCHES			WEIGHT VOL	
		H	W	D	LBS	FT <sup>3</sup>
BA1VTFS05	15	5	2.61	0.125	0.2	0.01
BA1VTFS13	26	13	2.61	0.125	0.4	0.01
BA1VTFS17	36	17	2.61	0.125	0.4	0.01
BA1VTFS21	39	21	2.61	0.125	0.6	0.02
BA1VTFS29	45	19	2.61	0.125	0.7	0.03
BA1VTFS37	54	37	2.61	0.125	1.1	0.03
BA1VTFS45	64	45	2.61	0.125	1.3	0.04

**BA1TTRF • Aluminum Top Cap**

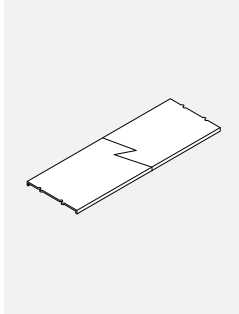

- Provides a finish detail to the top of a Boulevard 1 panel.
- Designed to snap to the top of a panel rail.
- Must be used on panels of corresponding width.
- Site installed.
- For applications using transaction tops and top mounted storage, please use BHBT02FT bracket
- To be used with Flat Vertical Trim.

PRODUCT CODE	PRICE	SIZE/INCHES			WEIGHT VOL	
		H	W	D	LBS	FT <sup>3</sup>
BA1TTRF06	15	0.125	6	2.61	0.2	0.01
BA1TTRF18	16	0.125	18	2.61	0.6	0.02
BA1TTRF24	20	0.125	24	2.61	0.7	0.03
BA1TTRF30	23	0.125	30	2.61	0.9	0.04
BA1TTRF36	28	0.125	36	2.61	1.1	0.05
BA1TTRF42	34	0.125	42	2.61	1.3	0.06
BA1TTRF48	39	0.125	48	2.61	1.5	0.06
BA1TTRF54	45	0.125	54	2.61	1.6	0.07
BA1TTRF60	50	0.125	60	2.61	1.8	0.08
BA1TTRF66	55	0.125	66	2.61	2.0	0.09
BA1TTRF72	58	0.125	72	2.61	2.2	0.10



**BA1PCF • Post Cap**

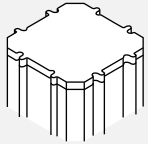

- Bridges the height difference when using Boulevard 1 panels only with Aluminum Horizontal Top Trims.
- Injection molded post cap to fit on top of 90 degree corner post.
- Extends post's overall height to the level corresponding with the height of aluminum horizontal top trim installed on standard Boulevard panel.
- Site installed.
- Used for Boulevard 1 panels when top aluminum horizontal trim is used.

PRODUCT CODE	PRICE	SIZE/INCHES			WEIGHT VOL	
		H	W	D	LBS	FT <sup>3</sup>
BA1PCF	10	0.25	2.61	2.61	0.02	0.01

**BHBT37FT • Transaction Bracket for 37" Panels With Flat Trim**



- Provides a secure attachment of a transaction worksurface for a 37" high panel with top trim.
- Includes a left and right bracket and bracket retainer clips.

PRODUCT CODE	PRICE	SIZE/INCHES			WEIGHT VOL	
		H	W	D	LBS	FT <sup>3</sup>
BHBT37FT	32	3.3	1.5	2.3	2.0	0.010

**BHBT02FT • Transaction Bracket for 42" Panels With Flat Trim**



- Provides a secure attachment of a transaction worksurface for 42" high Boulevard panels with flat trim.
- Includes a left and right bracket and bracket retainer clips.

PRODUCT CODE	PRICE	SIZE/INCHES			WEIGHT VOL	
		H	W	D	LBS	FT <sup>3</sup>
BHBT02FT	31	4	1	3	0.5	0.007

**FRC • Fabric Raceway Cover**

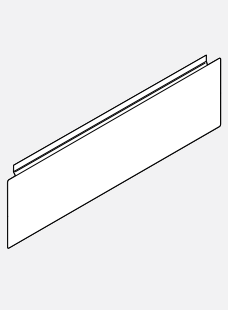

- Offers an alternative to the existing raceway options.
- Cover hinges upward for easy access to power and data/communication terminals.
- Cover may be removed for installation and reconfiguration.
- May not be used with Boulevard System 3 panels.
- Sold as singles.

PRODUCT CODE	PRICE	SIZE/INCHES			WEIGHT VOL	
		H	W	D	LBS	FT <sup>3</sup>
FRC24	38	7	23	0.125	1.4	0.001
FRC30	45	7	29	0.125	1.8	0.002
FRC36	50	7	35	0.125	2.2	0.002
FRC42	54	7	41	0.125	2.5	0.002
FRC48	59	7	47	0.125	2.9	0.003
FRC54	66	7	53	0.125	3.2	0.003
FRC60	74	7	59	0.125	3.7	0.003
FRC66	79	7	65	0.125	4.1	0.004
FRC72	81	7	72	0.125	4.4	0.004

**RCW-D • PVC Face-Mount Raceway Cover**

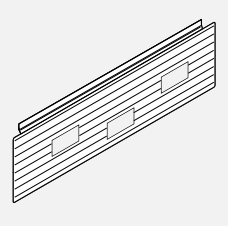

- PVC raceway cover is punched out to align with the Face-Mount Power Distribution Housing and Duplexes.
- Data punch-out accepts industry standard terminal faceplates (not supplied by Teknion Inc.) Size of opening is 1.37" x 2.755".
- Electrical cut-outs have black PVC trim. Size of opening is 1.5" x 2.85".
- May not be used with Boulevard System 3 Panels.
- Cover hinges upward for easy access to power and data/communication terminals.

PRODUCT CODE	PRICE	SIZE/INCHES			WEIGHT VOL	
		H	W	D	LBS	FT <sup>3</sup>
RCW24D	33	7	24	0.125	3	0.05
RCW30D	36	7	30	0.125	3	0.06
RCW36D	39	7	36	0.125	4	0.07
RCW42D	45	7	42	0.125	5	0.08
RCW48D	49	7	48	0.125	5	0.09
RCW54D	52	7	54	0.125	6	0.10
RCW60D	55	7	60	0.125	7	0.11
RCW66D	59	7	66	0.125	7	0.12
RCW72D	64	7	72	0.125	8	0.12

**FCR-D • Fabric-Covered Face-Mount Raceway**

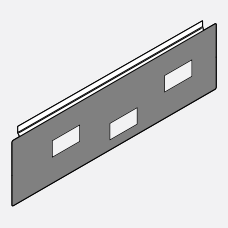

- Fabric raceway cover is punched out to align with the Face-Mount Power Distribution Housing and Duplexes.
- Data punch-out accepts industry standard terminal faceplates (not supplied by Teknion Inc.) Size of opening is 1.37" x 2.755".
- Electrical cut-outs have black PVC trim. Size of opening is 1.5" x 2.85".
- May not be used with Boulevard System 3 Panels.
- Cover hinges upward for easy access to power and data/communication terminals.

PRODUCT CODE	PRICE	SIZE/INCHES			WEIGHT VOL	
		H	W	D	LBS	FT <sup>3</sup>
FCR24D	83	7	24	0.125	3	0.05
FCR30D	92	7	30	0.125	3	0.06
FCR36D	101	7	36	0.125	4	0.07
FCR42D	109	7	42	0.125	5	0.08
FCR48D	118	7	48	0.125	5	0.09
FCR54D	126	7	54	0.125	6	0.10
FCR60D	135	7	60	0.125	7	0.11
FCR66D	144	7	66	0.125	7	0.12
FCR72D	164	7	72	0.125	8	0.12

**RCA-D • Aluminum Raceway Cover for Face Mounted**

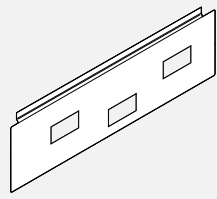

- Aluminum raceway cover is punched out to align with the Face-Mount Power Distribution Housing and Duplexes.
- Data punch-out accepts industry standard terminal faceplates (not supplied by Teknion Inc.) Size of opening is 1.37" x 2.755".
- Electrical cut-outs have black PVC trim. Size of opening is 1.5" x 2.85".
- May not be used with Boulevard System 3 Panels.
- Cover hinges upward for easy access to power and data/communication terminals.

PRODUCT CODE	PRICE	SIZE/INCHES			WEIGHT VOL	
		H	W	D	LBS	FT <sup>3</sup>
RCA24D	54	7	24	0.125	2.0	0.06
RCA30D	58	7	30	0.125	2.1	0.06
RCA36D	64	7	36	0.125	2.2	0.07
RCA42D	69	7	42	0.125	2.5	0.08
RCA48D	71	7	48	0.125	2.9	0.09
RCA54D	76	7	54	0.125	3.2	0.10
RCA60D	81	7	60	0.125	3.7	0.11
RCA66D	86	7	66	0.125	3.9	0.12
RCA72D	90	7	72	0.125	4.1	0.12

**RCW-SCH • Chicago Face-Mount Raceway Cover - Single Cutout**

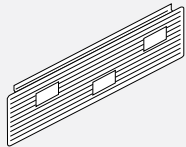

- PVC raceway cover is punched out to align with the Face-Mount Power Distribution Housing and Duplexes.
- Raceway has a single punch out
- Data punchout accepts industry standard terminal faceplates (not supplied by Teknion Inc.) Size of opening is 1.37" x 2.755".
- Electrical cutouts have black PVC trim. Size of opening is 1.5" x 2.85".
- May not be used with Boulevard System 3 Panels.
- Cover hinges upward for easy access to power and data/communication terminals.

PRODUCT CODE	PRICE	SIZE/INCHES			WEIGHT VOL	
		H	W	D	LBS	FT <sup>3</sup>
RCW24SCH	36	7	24	0.13	3.0	0.050
RCW30SCH	38	7	30	0.13	3.0	0.060
RCW36SCH	42	7	36	0.13	4.0	0.070
RCW42SCH	49	7	42	0.13	5.0	0.080
RCW48SCH	53	7	48	0.13	5.0	0.090
RCW54SCH	55	7	54	0.13	6.0	0.100
RCW60SCH	59	7	60	0.13	7.0	0.110
RCW66SCH	65	7	66	0.13	7.0	0.120
RCW72SCH	69	7	72	0.13	8.0	0.120

**FCR-SCH • Chicago Fabric-Covered Face-Mount Raceway Cover - Single Cutout**

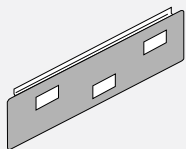

- Fabric raceway cover is punched out to align with the Face-Mount Power Distribution Housing and Duplexes.
- Raceway has a single punch out
- Data punchout accepts industry standard terminal faceplates (not supplied by Teknion Inc.) Size of opening is 1.37" x 2.755".
- Electrical cutouts have black PVC trim. Size of opening is 1.5" x 2.85".
- May not be used with Boulevard System 3 Panels.
- Cover hinges upward for easy access to power and data/communication terminals.

PRODUCT CODE	PRICE	SIZE/INCHES			WEIGHT VOL	
		H	W	D	LBS	FT <sup>3</sup>
FCR24SCH	83	7	24	0.13	3.0	0.050
FCR30SCH	92	7	30	0.13	3.0	0.060
FCR36SCH	101	7	36	0.13	4.0	0.070
FCR42SCH	109	7	42	0.13	5.0	0.080
FCR48SCH	118	7	48	0.13	5.0	0.090
FCR54SCH	126	7	54	0.13	6.0	0.100
FCR60SCH	135	7	60	0.13	7.0	0.110
FCR66SCH	144	7	66	0.13	7.0	0.120
FCR72SCH	164	7	72	0.13	8.0	0.120

**RCA-SCH • Chicago Aluminum Face-Mount Raceway Cover - Single Cutout**

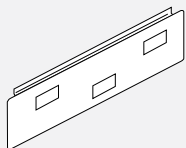

- Aluminum raceway cover is punched out to align with the Face-Mount Power Distribution Housing and Duplexes.
- Raceway has a single punch out
- Data punchout accepts industry standard terminal faceplates (not supplied by Teknion Inc.) Size of opening is 1.37" x 2.755".
- Electrical cutouts have black PVC trim. Size of opening is 1.5" x 2.85".
- May not be used with Boulevard System 3 Panels.
- Cover hinges upward for easy access to power and data/communication terminals.

PRODUCT CODE	PRICE	SIZE/INCHES			WEIGHT VOL	
		H	W	D	LBS	FT <sup>3</sup>
RCA24SCH	58	7	24	0.13	2.0	0.060
RCA30SCH	64	7	30	0.13	2.1	0.060
RCA36SCH	69	7	36	0.13	2.2	0.070
RCA42SCH	72	7	42	0.13	2.5	0.080
RCA48SCH	75	7	48	0.13	2.9	0.090
RCA54SCH	81	7	54	0.13	3.2	0.100
RCA60SCH	86	7	60	0.13	3.7	0.110
RCA66SCH	92	7	66	0.13	3.9	0.120
RCA72SCH	96	7	72	0.13	4.1	0.120

**RCW-DCH • Chicago Face-Mount Raceway Cover - Double Cutout**

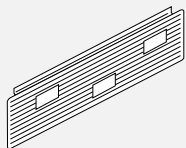

- PVC raceway cover is punched out to align with the Face-Mount Power Distribution Housing and Duplexes.
- Raceway has a double punch out
- Data punchout accepts industry standard terminal faceplates (not supplied by Teknion Inc.) Size of opening is 1.37" x 2.755".
- Electrical cutouts have black PVC trim. Size of opening is 1.5" x 2.85".
- May not be used with Boulevard System 3 Panels.
- Cover hinges upward for easy access to power and data/communication terminals.

PRODUCT CODE	PRICE	SIZE/INCHES			WEIGHT VOL	
		H	W	D	LBS	FT <sup>3</sup>
RCW24DCH	38	7	24	0.13	3.0	0.050
RCW30DCH	41	7	30	0.13	3.0	0.060
RCW36DCH	45	7	36	0.13	4.0	0.070
RCW42DCH	53	7	42	0.13	5.0	0.080
RCW48DCH	58	7	48	0.13	5.0	0.090
RCW54DCH	60	7	54	0.13	6.0	0.100
RCW60DCH	66	7	60	0.13	7.0	0.110
RCW66DCH	70	7	66	0.13	7.0	0.120
RCW72DCH	75	7	72	0.13	8.0	0.120

**FCR-DCH • Chicago Fabric-Covered Face-Mount Raceway Cover - Double Cutout**

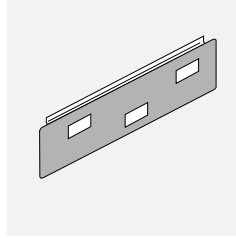

- Fabric raceway cover is punched out to align with the Face-Mount Power Distribution Housing and Duplexes.
- Raceway has a single punch out
- Data punchout accepts industry standard terminal faceplates (not supplied by Teknion Inc.) Size of opening is 1.37" x 2.755".
- Electrical cutouts have black PVC trim. Size of opening is 1.5" x 2.85".
- May not be used with Boulevard System 3 Panels.
- Cover hinges upward for easy access to power and data/communication terminals.

PRODUCT CODE	PRICE	SIZE/INCHES			WEIGHT VOL	
		H	W	D	LBS	FT <sup>3</sup>
FCR24DCH	83	7	24	0.13	3.0	0.050
FCR30DCH	92	7	30	0.13	3.0	0.060
FCR36DCH	101	7	36	0.13	4.0	0.070
FCR42DCH	109	7	42	0.13	5.0	0.080
FCR48DCH	118	7	48	0.13	5.0	0.090
FCR54DCH	126	7	54	0.13	6.0	0.100
FCR60DCH	135	7	60	0.13	7.0	0.110
FCR66DCH	144	7	66	0.13	7.0	0.120
FCR72DCH	164	7	72	0.13	8.0	0.120

**RCA-DCH • Chicago Aluminum Face-Mount Raceway Cover - Double Cutout**

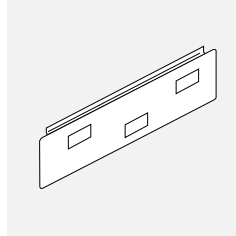

- Aluminum raceway cover is punched out to align with the Face-Mount Power Distribution Housing and Duplexes.
- Raceway has a single punch out
- Data punchout accepts industry standard terminal faceplates (not supplied by Teknion Inc.) Size of opening is 1.37" x 2.755".
- Electrical cutouts have black PVC trim. Size of opening is 1.5" x 2.85".
- May not be used with Boulevard System 3 Panels.
- Cover hinges upward for easy access to power and data/communication terminals.

PRODUCT CODE	PRICE	SIZE/INCHES			WEIGHT VOL	
		H	W	D	LBS	FT <sup>3</sup>
RCA24DCH	64	7	24	0.13	2.0	0.060
RCA30DCH	69	7	30	0.13	2.1	0.060
RCA36DCH	75	7	36	0.13	2.2	0.070
RCA42DCH	79	7	42	0.13	2.5	0.080
RCA48DCH	82	7	48	0.13	2.9	0.090
RCA54DCH	88	7	54	0.13	3.2	0.100
RCA60DCH	93	7	60	0.13	3.7	0.110
RCA66DCH	99	7	66	0.13	3.9	0.120
RCA72DCH	104	7	72	0.13	4.1	0.120

**BPMB • Raceway Cover Caps**

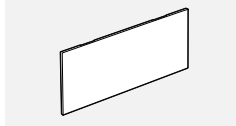

- To provide clean detail for the punch-outs of a raceway cover when the punch-outs are not in use. Order only when required.
- Made of injection molded ABS.
- B = Black
- W = White
- G = Grey

PRODUCT CODE	PRICE	SIZE/INCHES			WEIGHT VOL	
		H	W	D	LBS	FT <sup>3</sup>
BPMB020104B	10	1.5	3	0.125	0.04	0.02
BPMB020104G	10	1.5	3	0.125	0.04	0.02
BPMB020104W	10	1.5	3	0.125	0.04	0.02

**BHSL • Safety Lock**

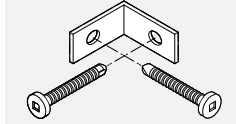

- Provides customers a higher degree of privacy.
- Safety Lock is a set of two ready made brackets and
- It is installed from the inside of a panel adjacent to a opening the door through the raceway.
- To be used for PVC raceways only.

PRODUCT CODE	PRICE
BHSL02	31

**BHV • Component Wall Adapter - Single and Double**

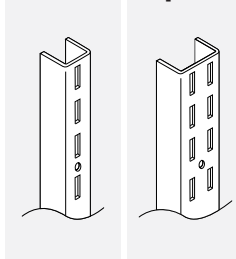

- Used to attach system components to fixed wall.
- Panel frame finish.
- The vertical wall adapter is a "U" shaped channel with a vertical row of slots with 1" centers.
- The double Component Wall Adapter has a double row of slots with 1" centers.
- Comes in 60" length only.
- Care should be taken to mount adapters only to wall studs using correct fasteners.
- Does not include mounting hardware. Mounting hardware selection to be based on wall material.
- Sold in pairs.
- Failure to do this may result in collapse of the unit and subsequent possible personal injury.

PRODUCT CODE	PRICE	SIZE/INCHES			WEIGHT VOL	
		H	W	D	LBS	FT <sup>3</sup>
BHV01	77	60	0.75	0.5	4	0.009
BHV02	91	60	1.50	0.5	5	0.026

**BECC01 • Cable Terminal Channel**

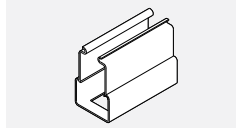

- Houses various combinations of voice and data cables.
- 1 included with every Raceway Panel.
- Accommodates assorted snap-in modular voice and data terminals (not supplied by Teknion Inc).
- Black only.

PRODUCT CODE	PRICE	SIZE/INCHES			WEIGHT VOL	
		H	W	D	LBS	FT <sup>3</sup>
BECC01	10	6	4.5	2.5	.20	0.21

**BPHC01 • Cable Terminal Channel**



- Houses various combinations of voice and data cables.
- 2 included with every Raceway Panel.
- Black only.
- For use with Boulevard 1 Panels only.

PRODUCT CODE	PRICE	SIZE/INCHES			WEIGHT VOL	
		H	W	D	LBS	FT <sup>3</sup>
BPHC01	7	2.5	1	2	0.1	0.003

## BOULEVARD SYSTEM 3 PANEL SYSTEM

Boulevard System 3... The next generation of BOULEVARD offers the freedom to plan the office environment 'your way', while keeping an eye on the bottom line. Boulevard System 3 boasts a rich toolbox featuring stack-on panels, complete data/communication lay-in at the top, comprehensive power and data/communication at both the base and at desk height, a selection of interchangeable tiles, monolithic panels, up-mounted storage, new ergonomic worksurface shapes & a revised color pallet featuring recycled fabrics... all wrapped up in a sophisticated design statement. Enjoy planning it your way and having the tools to really do it. Boulevard System 3 offers the building blocks to create the framework that perfectly suits your office environment. Combinations of fabric, glazed, open and slat wall panel surface tiles effectively support the creation of various work settings, whether open (to encourage interaction and teamwork) or traditional, with enclosed functional task organizers. Boulevard System 3 lets you plan more effectively and with more versatility than ever before. It is simple to comprehend,

specify, install, maintain and reconfigure. Offering multifunctional furnishing solutions, Boulevard System 3 can be specified on its own or used as a power/data and privacy provider, bridging freestanding/mobile furniture and panels and task related options such as worksurface shapes that help you work better. By utilizing up-mount storage, lower panel heights can be maintained without sacrificing overhead storage where and when needed. Another value-oriented tool... Consider 'Spine' planning to create a power wall that feeds data/communication to a string of perpendicular offices. Incorporate monolithic panels which offer the best cost/performance advantages for value sensitive environments with base panel raceway power/data cable distribution, while adding visual interest...and of course, reconfiguration is a breeze. Now you can have an endless visual pallet and array of practical solutions for today's ever changing and demanding workplace. When you add it all up, Boulevard System 3 gives you more value than ever before.

## TECHNICAL INFORMATION

### Panels

All panels are 2 5/8" thick.  
Lightweight aluminum box frame construction creates superior panel rigidity.  
Panel frame finish is durable epoxy powder coated.  
Hang-on capabilities at 1" increments.  
Patented "Knuckle-Loc" design provides solid panel-to-panel connection for fast installation and reconfiguration.  
Knuckle lock feature ensures even panel heights throughout installation.  
3" glide stem permits 2 1/2" height adjustment.  
Panel sizes are actual, eliminating creepage.  
Vertical end trims must be specified to give the panel a finished appearance.  
Horizontal top trims are included with all panels.  
All panels include 2 "Capture Strip" panel connectors.  
Panels are UL listed and CSA approved and have a Class "A" fire rating except when Customer's Own Material (COM) is used.  
All panels accept Over Panels (see page D.7).

### Panel Options

Laminate, whiteboard, or corkboard may be substituted for fabric on panels only, see "OPT" column.  
Laminate and whiteboard are held in place with a PVC retainer matching the frame color and can be retrofitted on site.  
Laminate and whiteboard options reduce the acoustical value of the panel.

### Monolithic Panels

- Fabric on Monolithic Panels can be re-upholstered on site.

### Pass-Thru Panels

- Fabric at base of Pass-Thru Panels can be re-upholstered on site.
- Tiles cannot be re-upholstered on site.

### Bottom Lay-in Raceway

Bottom raceway snaps to the bottom of the panel and can be completely removed for unobstructed cable lay-in installation.  
Bottom lay-in raceway is 60 mm (2.380") wide x 141 mm (5.560") high.  
Maximum capacity: 70 cables 5 mm (0.200) diameter, 2 parallel 8 wire, 4 circuit power distribution.  
State-of-the-art engineering.  
Snap-in modularity of all electrical components including harnesses, distribution housings, duplexes and circuit designations.  
All power and data outlets are easily accessible from both sides of panel.  
8 wire system with 4, 15 amp circuits (including 1 dedicated circuit).  
Face-mount electrical with 2 duplex per panel side.  
Included is 1 data/communication terminal bracket per side.

Raceway cover openings of 2.71" x 1.38" can accommodate a single modular Data/Comm terminal plate per side (not supplied by Teknion Inc).  
Opening complies with the ANSI/TIA/EIA standard furniture openings.  
Outlet and circuit changes accomplished without disruption to work station.  
Large raceway cavity permits storage of excess cables and equipment cords.  
Total flexibility for 8 wire system: choice of up to 4 duplexes per panel; choice of circuitry in each duplex .  
Unique design of fire retardant metal raceway cover permits access to raceway without disruption to equipment.

### Horizontal Lay-in Channel (Excluding all panels with Embedded Glass)

Integrated horizontal lay-in channel 33.5 m (1.320") wide and 38 mm (1.500") high at the top of panels and on top of the door frame.  
Maximum capacity: 36 cables 5 mm (0.200") in diameter.  
Maximum cable bending radius between two perpendicular panels: 141.2 mm (5.560") [5 mm (0.200") in diameter cables].

### Vertical Wire Channel

Where applicable, the vertical wire channel connects horizontal channel above desk height with floor level raceway.  
Opening in horizontal channel allows for vertical cable passage from top lay-in channel to base raceway.  
Integrated vertical channel 76 mm (2.990") x 27 mm (1.060").  
Maximum capacity: 60 cables 5 mm (0.200") in diameter.  
Maximum cable bending radius: 141.2 mm (5.560").

### Posts

Enables connection for multiple panel runs such as 90°, 45° or 60° angle and 2 way, 3 way or 4 way.  
Starts at the top of the bottom lay-in raceway.  
90 degree post provides route for ceiling power and data entry to a panel raceway.  
Knuckle lock feature maintains even height of all connected panels.  
Solid lightweight aluminum extrusion fits together through a unique "Knuckle-Loc" design providing rigid post-to-panel connection.  
Post has punch-outs at the top to allow for unobstructed horizontal cable passage between adjacent panels.  
Includes all required panel connectors and caps.  
Posts add 2 5/8" to a panel run.  
Posts are 1/8" oversized to allow for "panel wrap around" of freestanding desks.  
For all panel runs with multiple posts, this 1/8" must be allotted for.  
Maximum capacity:

- 80 cables 5 mm (0.200") diameter
- 65 cables 5 mm (0.200") diameter with 1 power feed
- 50 cables 5 mm (0.200") diameter with 2 power feeds

**PANELS - GUIDELINES FOR ORDERING PRODUCT**

**Codes**

The product guide uses a numbering system with meaningful alphanumeric characters to create a simple-to-understand product number. This makes specifying the product much easier and more accurate.

Example of Panel: **BPX3MA6636 CHR CHR P1 AN50**

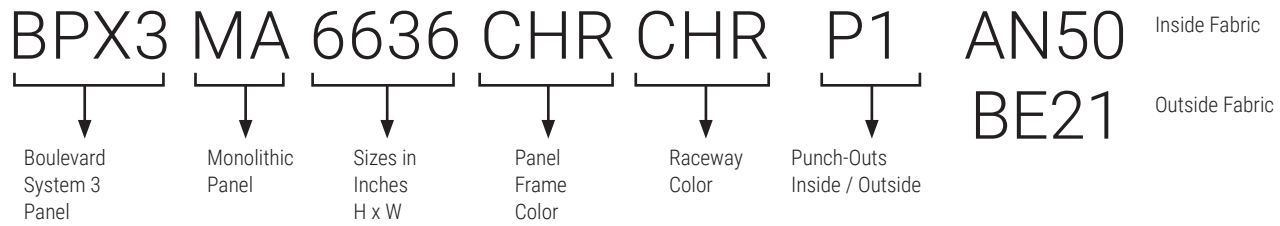

**How to Specify**

Specify Boulevard System 3 panel type and size by code.

Specify panel frame finish - ie. CHR (Charcoal).

Specify PVC raceway finish - ie. CHR (Charcoal). If raceway color not specified at time of order, default will be the panel frame color.

Specify all two panel fabric options if necessary.

Some fabrics have directional pattern and cannot be applied horizontally or vertically. Panels wider than 60" will have fabrics applied horizontally (railroad).

Please specify if you want adjacent panels and the rest of the installation upholstered the same way.

Specify whether punchouts are required inside and outside of raceway or if no knockouts are required.

- P2 - Punch-Outs on both sides.
- P1 - Punch-Outs on one side.
- NP - No punchouts.

For special width panels, a special must be processed and additional costs apply.

Please contact your customer service representative.

Example of Post: **BH3PS066 CHR**

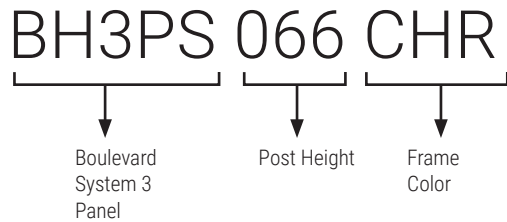

**How to Specify**

Specify Boulevard System 3 post by code.

Specify frame color - ie. CHR (Charcoal).

**ORDERS****Each Order Must Include:**

Purchase Order  
 Layout showing where the image(s) appear in the run of panels.  
 A completed Price Chart, showing the location of the image(s) on each appropriate panel.

Artwork must be submitted in accordance with the following artwork specifications.

**NOTE:** Final artwork specification approval must be given before order can be processed.

**TRANSFER DEVICES**

- E-mail up to 10MB to your Teknion Customer Service Representative.
- Courier CD/DVD/USB stick to your Teknion Customer Service Representative.

**ARTWORK SPECIFICATIONS**

- Non-Photographic artwork should be vector art, saved in Adobe Illustrator (.ai) or as an EPS (.eps)
- All bitmap or photographic artwork has to be at a minimum of 100 dpi at the full size of the panel to be printed.
- We accept Adobe CS5 files.
- Any linked files must be included or imbedded.
- Leave any PSD files unflattened
- All fonts must be converted to outlines.
- Do not convert to CMYK, leave all images as RGB if possible
- No Word, Powerpoint, Publisher or other Microsoft files can be used.
- Include a PDF or .jpg for reference when sending native Photoshop or Illustrator format files.

**COLOR MATCHING**

A Pantone color reference must be supplied or we cannot accept responsibility for correct color.

When it is not possible to refer to Pantone colors, we will do our best to meet your requirements.

**IMAGE CLARITY**

We will advise should the selected image not lend itself to the element size requested.

**NOTE**

We reserve the right to put an order on hold when the files are found to be incomplete or when documents have been either incorrectly saved. Fonts not

converted to curves or the job appears not to be commercially acceptable.

**IMAGE BLEED**

To facilitate placement on the panel. Extension of the image past the finished visible area of the panel (bleed) is required

- Boulevard Panels need a 5" Bleed on all sides.

**EXAMPLE OF IMAGE RESOLUTION**

The resolution required for a 36 wide x 24 high Boulevard panel at 100dpi (minimum resolution)

The resolution required for a 36 wide x 24 high Boulevard panel at 300dpi (higher quality)

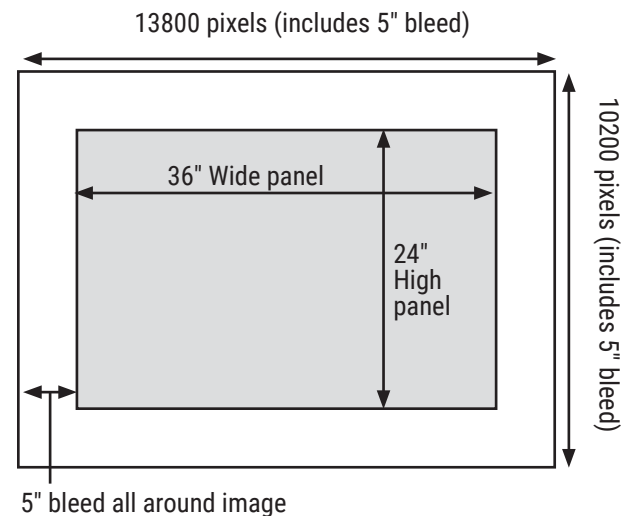
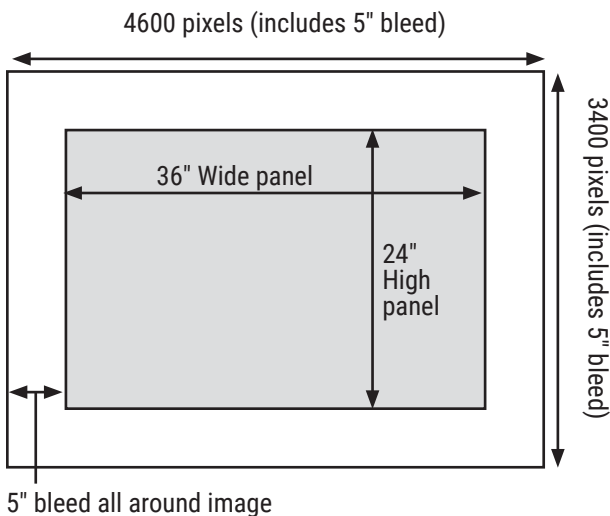

**Pricing, Initial Set-Up Charge per Image: \$235 net**

**Boulevard System 3 Tiles**

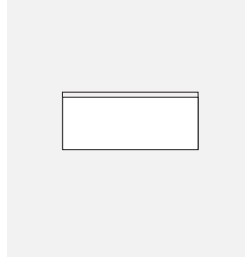

This List applies to the following panels:  
BP3FTxxxx  
BP3ETxxxx

PANEL WIDTH	HEIGHT 8"	LIST PRICE 16"
24"	191	280
30"	226	331
36"	260	381
42"	301	431
48"	331	350
54"	372	540
60"	401	592
66"	431	632
72"	471	681

**Boulevard System 3 Bottom Section of Pass-Thru Panel**

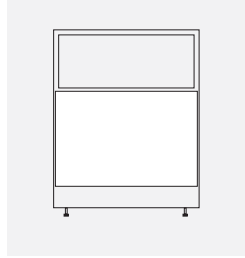

This List applies to the following panels:  
BPX3PTxxxx  
BPX3PVxxxx

PANEL WIDTH	LIST PRICE 28"
24"	401
30"	471
36"	540
42"	621
48"	691
54"	761
60"	832
66"	901
72"	971

**Boulevard System 3 Monolithic Panels**

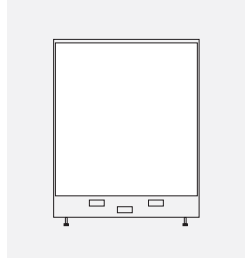

This List applies to the following panels:  
BPX3MAxxxx  
BPX3MVxxxx

PANEL WIDTH	HEIGHT 34"	HEIGHT 42"	HEIGHT 50"	HEIGHT 66"
24"	401	491	572	751
30"	471	572	681	881
36"	540	660	782	1021
42"	621	751	871	1162
48"	691	841	1002	1292
54"	761	930	1091	1432
60"	832	1021	1203	1561
66"	901			
72"	971			

Note: Prices shown are an upcharge to the panel price, please add to the list price of panel which you are specifying the graphic for.

**BPX3MA • Monolithic Acoustical Panel**

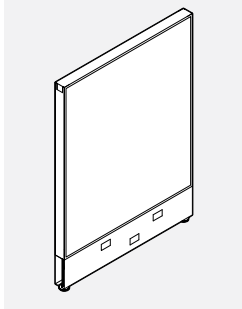

- Provides visual and acoustic privacy.
- Center septum above raceway overlaid on either side with 1 1/8" "Sound absorbent mineral board."
- Acoustic rating of .70 NRC and 25 STC.
- OPT\* = Laminate or Whiteboard
- "No Knockouts" option for raceways available at no additional charge. Please choose option for interior and/or exterior raceways.

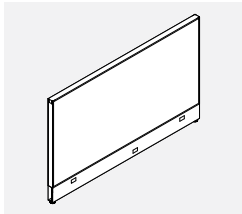

72" Wide

PRODUCT CODE	PRICE			SIZE / INCHES			WEIGHT VOL	
	GR 1	GR 2	OPT*	H	W	D	LBS	FT <sup>3</sup>
BPX3MA3418	313	333	352	34	18	2.61	11	1.337
BPX3MA3424	350	372	392	34	24	2.61	12	1.738
BPX3MA3430	383	404	422	34	30	2.61	13	2.139
BPX3MA3436	419	457	496	34	36	2.61	15	2.540
BPX3MA3442	452	490	531	34	42	2.61	16	2.941
BPX3MA3448	487	524	566	34	48	2.61	18	3.342
BPX3MA3454	523	561	601	34	54	2.61	20	3.743
BPX3MA3460	557	593	636	34	60	2.61	22	4.144
BPX3MA3466	762	815	871	34	66	2.61	26	4.612
BPX3MA3472	965	1018	-	34	72	2.61	30	5.080
BPX3MA4218	338	363	389	42	18	2.61	12	1.782
BPX3MA4224	374	401	426	42	24	2.61	13	2.317
BPX3MA4230	411	437	464	42	30	2.61	15	2.852
BPX3MA4236	447	497	551	42	36	2.61	17	3.387
BPX3MA4242	486	536	590	42	42	2.61	19	3.921
BPX3MA4248	522	572	626	42	48	2.61	21	4.456
BPX3MA4254	561	610	664	42	54	2.61	23	4.991
BPX3MA4260	597	646	701	42	60	2.61	25	5.525
BPX3MA4266	848	951	1060	42	66	2.61	29	6.148
BPX3MA4272	1099	1203	-	42	72	2.61	34	6.770
BPX3MA5018	435	473	514	50	18	2.61	13	2.106
BPX3MA5024	479	517	557	50	24	2.61	15	2.738
BPX3MA5030	523	561	601	50	30	2.61	17	3.370
BPX3MA5036	571	646	728	50	36	2.61	20	4.002
BPX3MA5042	642	717	798	50	42	2.61	23	4.634
BPX3MA5048	660	736	816	50	48	2.61	24	5.266
BPX3MA5054	703	781	859	50	54	2.61	25	5.898
BPX3MA5060	750	826	907	50	60	2.61	27	6.530
BPX3MA5066	1049	1153	1263	50	66	2.61	33	7.265
BPX3MA5072	1346	1450	-	50	72	2.61	40	8.000
BPX3MA5418	490	528	570	54	18	2.61	14	2.406
BPX3MA5424	536	574	616	54	24	2.61	16	3.181
BPX3MA5430	570	605	646	54	30	2.61	19	3.907
BPX3MA5436	633	708	789	54	36	2.61	22	4.602
BPX3MA5442	679	754	835	54	42	2.61	25	5.306
BPX3MA5448	727	802	883	54	48	2.61	26	5.966
BPX3MA5454	770	847	925	54	54	2.61	27	7.287
BPX3MA5460	820	897	977	54	60	2.61	30	7.539
BPX3MA6618	508	570	638	66	18	2.61	14	2.755
BPX3MA6624	555	619	685	66	24	2.61	17	3.581
BPX3MA6630	601	664	734	66	30	2.61	20	4.407
BPX3MA6636	652	751	859	66	36	2.61	24	5.234
BPX3MA6642	700	800	907	66	42	2.61	26	6.060
BPX3MA6648	748	851	956	66	48	2.61	28	6.887
BPX3MA6654	793	896	1003	66	54	2.61	30	7.713
BPX3MA6660	843	945	1052	66	60	2.61	32	8.539



**BPX3MV • Monolithic Acoustical Panel With Vertical Wire Channel**

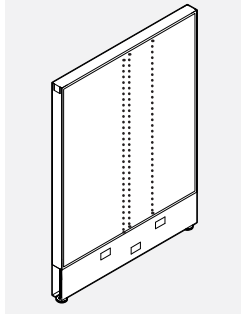

- Provides visual and acoustic privacy and allows for vertical cable passage from top lay-in channel to bottom raceway within panel.
- Center septum above raceway overlaid on either side with 1 1/8" "Sound absorbent mineral board."
- Acoustic rating of .70 NRC and 25 STC. Includes integrated vertical wire channel.
- OPT\* = Laminate or Whiteboard
- "No Knockouts" option for raceways available at no additional charge. Please choose option for interior and/or exterior raceways.

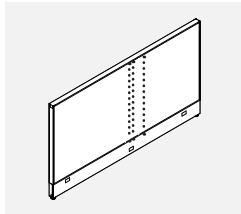

72" Wide

PRODUCT CODE	PRICE			SIZE/INCHES			WEIGHT VOL	
	GR 1	GR 2	OPT*	H	W	D	LBS	FT <sup>3</sup>
BPX3MV3430	414	433	450	34	30	2.61	15	2.139
BPX3MV3436	447	484	530	34	36	2.61	17	2.540
BPX3MV3442	481	519	561	34	42	2.61	18	2.941
BPX3MV3448	518	555	597	34	48	2.61	20	3.342
BPX3MV3454	552	589	631	34	54	2.61	22	3.743
BPX3MV3460	587	624	664	34	60	2.61	24	4.144
BPX3MV3466	808	860	917	34	66	2.61	29	4.612
BPX3MV3472	1027	1061	-	34	72	2.61	34	5.080
BPX3MV4230	503	533	565	42	30	2.61	17	2.852
BPX3MV4236	486	536	590	42	36	2.61	19	3.387
BPX3MV4242	524	576	628	42	42	2.61	21	3.921
BPX3MV4248	561	609	664	42	48	2.61	23	4.456
BPX3MV4254	599	648	703	42	54	2.61	25	4.991
BPX3MV4260	636	685	740	42	60	2.61	27	5.525
BPX3MV4266	908	1010	1122	42	66	2.61	32	6.148
BPX3MV4272	1180	1283	-	42	72	2.61	38	6.770
BPX3MV5030	572	608	652	50	30	2.61	19	3.370
BPX3MV5036	620	696	776	50	36	2.61	22	4.002
BPX3MV5042	662	739	817	50	42	2.61	25	4.634
BPX3MV5048	708	786	865	50	48	2.61	26	5.266
BPX3MV5054	751	829	908	50	54	2.61	27	5.898
BPX3MV5060	798	874	955	50	60	2.61	29	6.530
BPX3MV5066	1126	1227	1339	50	66	2.61	35	7.265
BPX3MV5072	1450	1554	-	50	72	2.61	40	8.000
BPX3MV5430	644	682	724	54	30	2.61	19	3.907
BPX3MV5436	692	768	849	54	36	2.61	22	4.602
BPX3MV5442	741	816	897	54	42	2.61	25	5.306
BPX3MV5448	789	865	945	54	48	2.61	26	5.966
BPX3MV5454	835	911	992	54	54	2.61	27	7.287
BPX3MV5460	881	957	1037	54	60	2.61	30	7.539
BPX3MV6630	669	733	800	66	30	2.61	22	4.407
BPX3MV6636	717	817	924	66	36	2.61	26	5.234
BPX3MV6642	766	867	973	66	42	2.61	28	6.060
BPX3MV6648	815	916	1024	66	48	2.61	30	6.887
BPX3MV6654	860	962	1069	66	54	2.61	32	7.713
BPX3MV6660	910	1010	1118	66	60	2.61	34	8.539

**BPX3MG • Monolithic Glazed Panel**

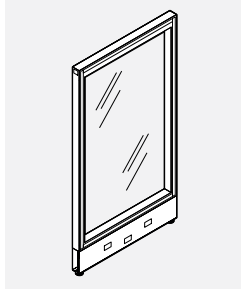

- Full-height glazing provides visual accessibility.
- Glazing is replaceable on site. Tempered clear glass standard.
- Glazing is standard on one side.
- "No Knockouts" option for raceways available at no additional charge. Please choose option for interior and/or exterior raceways.

PRODUCT CODE	PRICE	FRST	SIZE/INCHES			WEIGHT VOL	
			H	W	D	LBS	FT <sup>3</sup>
BPX3MG5024	763	916	50	24	2.61	25	2.738
BPX3MG5030	968	1164	50	30	2.61	29	3.370
BPX3MG5036	1026	1231	50	36	2.61	33	4.002
BPX3MG5042	1081	1297	50	42	2.61	36	4.634
BPX3MG5048	1139	1367	50	48	2.61	41	5.266
BPX3MG5424	763	916	54	24	2.61	29	3.138
BPX3MG5430	968	1164	54	30	2.61	34	3.807
BPX3MG5436	1026	1231	54	36	2.61	38	4.602
BPX3MG5442	1081	1297	54	42	2.61	43	5.334
BPX3MG5448	1139	1367	54	48	2.61	48	6.066
BPX3MG6624	950	1139	66	24	2.61	33	3.581
BPX3MG6630	1031	1237	66	30	2.61	39	4.407
BPX3MG6636	1115	1338	66	36	2.61	44	5.234
BPX3MG6642	1196	1435	66	42	2.61	49	6.060
BPX3MG6648	1275	1531	66	48	2.61	54	6.887

**BPX3PT • Pass-Thru Panel - Fabric Base**

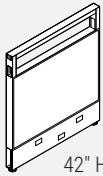

42" High

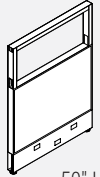

50" High

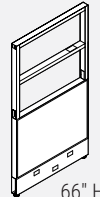

66" High

- Opening allows choice of tile above desk height.
- Solid fabric base up to 34".
- Single 8" opening above 34" for 42" high panels.
- Single 16" opening above 34" for 50" high panels.
- Two individual 16" openings above 34" for 66" high panels.
- Horizontal cable management at 34" height.
- OPT\* = Laminate or Whiteboard.
- "No Knockouts" option for raceways available at no additional charge. Please choose option for interior and/or exterior raceways.

PRODUCT CODE	PRICE			SIZE/INCHES			WEIGHT VOL	
	GR 1	GR 2	OPT*	H	W	D	LBS	FT <sup>3</sup>
BPX3PT4218	323	349	377	42	18	2.61	14	1.689
BPX3PT4224	365	389	419	42	24	2.61	16	2.233
BPX3PT4230	404	430	458	42	30	2.61	17	2.792
BPX3PT4236	441	468	495	42	36	2.61	19	3.351
BPX3PT4242	480	506	534	42	42	2.61	21	3.908
BPX3PT4248	520	546	574	42	48	2.61	23	4.466
BPX3PT4254	558	584	612	42	54	2.61	26	5.025
BPX3PT4260	598	624	652	42	60	2.61	27	5.592
BPX3PT4266	824	876	932	42	66	2.61	32	6.148
BPX3PT4272	1049	1102	-	42	72	2.61	38	6.700
BPX3PT5018	323	349	377	50	18	2.61	15	2.106
BPX3PT5024	365	389	419	50	24	2.61	17	2.738
BPX3PT5030	404	430	458	50	30	2.61	18	3.370
BPX3PT5036	441	468	495	50	36	2.61	20	4.002
BPX3PT5042	479	509	534	50	42	2.61	22	4.634
BPX3PT5048	520	546	574	50	48	2.61	24	5.266
BPX3PT5054	558	584	612	50	54	2.61	27	5.898
BPX3PT5060	598	624	652	50	60	2.61	29	6.530
BPX3PT5066	824	876	932	50	66	2.61	34	7.265
BPX3PT5072	1049	1102	-	50	72	2.61	40	8.000
BPX3PT6618	403	430	457	66	18	2.61	19	2.755
BPX3PT6624	447	475	501	66	24	2.61	21	3.581
BPX3PT6630	495	522	549	66	30	2.61	23	4.407
BPX3PT6636	544	570	597	66	36	2.61	25	5.234
BPX3PT6642	589	617	642	66	42	2.61	27	6.060
BPX3PT6648	637	663	691	66	48	2.61	30	6.887
BPX3PT6654	684	709	739	66	54	2.61	33	7.713
BPX3PT6660	733	759	787	66	60	2.61	36	8.539

**BPX3PV • Pass-Thru Panel With Vertical Wire Channel**

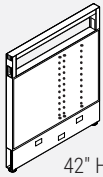

42" High

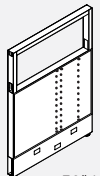

50" High

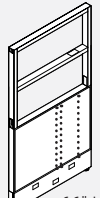

66" High

- Opening allows choice of tile above desk height. Vertical wire channel allows passage of cables from top lay-in channel to bottom raceway within panel.
- Solid fabric base up to 34".
- Single 8" opening above 34" for 42" high panels.
- Single 16" opening above 34" for 50" high panels.
- Two individual 16" openings above 34" for 66" high panels.
- Includes integrated vertical wire channel.
- Horizontal cable management at 34" height.
- OPT\* = Laminate or Whiteboard.
- "No Knockouts" option for raceways available at no additional charge. Please choose option for interior and or exterior raceways.

PRODUCT CODE	PRICE			SIZE/INCHES			WEIGHT VOL	
	GR 1	GR 2	OPT*	H	W	D	LBS	FT <sup>3</sup>
BPX3PV4230	441	468	495	42	30	2.61	19	2.792
BPX3PV4236	480	506	534	42	36	2.61	21	3.351
BPX3PV4242	520	546	574	42	42	2.61	23	3.908
BPX3PV4248	558	584	612	42	48	2.61	23	4.466
BPX3PV4254	598	624	652	42	54	2.61	28	5.025
BPX3PV4260	638	663	692	42	60	2.61	30	5.592
BPX3PV4266	863	917	972	42	66	2.61	36	6.148
BPX3PV4272	1089	1142	-	42	72	2.61	42	6.700
BPX3PV5030	441	468	495	50	30	2.61	20	3.370
BPX3PV5036	480	506	534	50	36	2.61	22	4.002
BPX3PV5042	520	546	574	50	42	2.61	24	4.634
BPX3PV5048	558	584	612	50	48	2.61	26	5.266
BPX3PV5054	598	624	652	50	54	2.61	29	5.898
BPX3PV5060	638	663	692	50	60	2.61	31	6.530
BPX3PV5066	863	917	972	50	66	2.61	37	7.265
BPX3PV5072	1089	1142	-	50	72	2.61	44	8.000
BPX3PV6630	534	561	588	66	30	2.61	25	4.407
BPX3PV6636	581	608	637	66	36	2.61	27	5.234
BPX3PV6642	628	657	682	66	42	2.61	29	6.060
BPX3PV6648	678	703	732	66	48	2.61	32	6.887
BPX3PV6654	723	749	777	66	54	2.61	35	7.713
BPX3PV6660	768	794	822	66	60	2.61	38	8.539

**BPX3PF • Pass-Thru Panel - Air Flow Base**

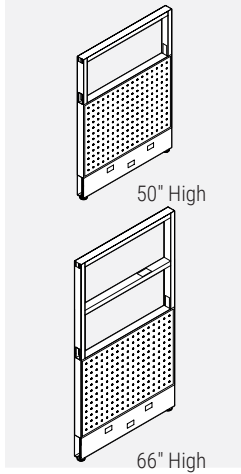

- Allows air to flow freely through the bottom of the panel.
- Double wall perforated metal base up to 34".
- Single 16" opening above 34" for 50" high panels.
- Two individual 16" openings above 34" for 66" high panels.
- Horizontal cable management at 34" height.
- "No Knockouts" option for raceways available at no additional charge. Please choose option for interior and/or exterior raceways.

PRODUCT CODE	PRICE	SIZE/INCHES			WEIGHT VOL	
		H	W	D	LBS	FT <sup>3</sup>
BPX3PF5018	450	50	18	2.61	17	2.106
BPX3PF5024	514	50	24	2.61	18	2.738
BPX3PF5030	574	50	30	2.61	20	3.370
BPX3PF5036	636	50	36	2.61	22	4.002
BPX3PF5042	698	50	42	2.61	23	4.634
BPX3PF5048	759	50	48	2.61	26	5.266
BPX3PF5054	820	50	54	2.61	28	5.898
BPX3PF5060	883	50	60	2.61	31	6.530
BPX3PF6618	528	66	18	2.61	21	2.755
BPX3PF6624	598	66	24	2.61	23	3.581
BPX3PF6630	669	66	30	2.61	25	4.407
BPX3PF6636	741	66	36	2.61	27	5.234
BPX3PF6642	815	66	42	2.61	29	6.060
BPX3PF6648	886	66	48	2.61	32	6.887
BPX3PF6654	957	66	54	2.61	35	7.713
BPX3PF6660	1029	66	60	2.61	37	8.539

**BPX3OP • Over Panel Frame**

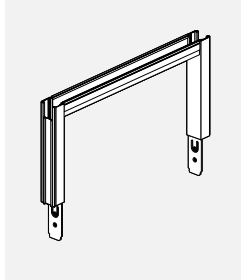

- **Attaches to the top of any Boulevard System 3 panel to create a floor-to-ceiling wall.**
- Any tile can be attached to either side to enclose the frame.
- Two non-slotted uprights at either end slide into vertical extrusions on the base panel.
- Shipped without horizontal and vertical trim; the horizontal trim from the base panel will be used.
- Openings in horizontal channels allow for vertical cable passage from top lay-in channel and behind the cover tiles
- Over Panel Frames 18" and 24" wide are not punched for vertical wire channel.
- Boulevard System 3 Over Panel is not compatible with Boulevard 1 panels.

PRODUCT CODE	PRICE	SIZE/INCHES			WEIGHT VOL	
		H	W	D	LBS	FT <sup>3</sup>
BPX3OP0818	77	8	18	2.61	3	0.383
BPX3OP0824	85	8	24	2.61	4	0.438
BPX3OP0830	93	8	30	2.61	4	0.656
BPX3OP0836	101	8	36	2.61	4	0.712
BPX3OP0842	110	8	42	2.61	5	0.875
BPX3OP0848	117	8	48	2.61	5	0.930
BPX3OP0854	124	8	54	2.61	6	1.040
BPX3OP0860	131	8	60	2.61	6	1.204
BPX3OP0866	191	8	66	2.61	7	1.310
BPX3OP0872	249	8	72	2.61	8	1.420
BPX3OP1618	77	16	18	2.61	4	0.638
BPX3OP1624	85	16	24	2.61	5	0.730
BPX3OP1630	93	16	30	2.61	5	1.094
BPX3OP1636	101	16	36	2.61	5	1.186
BPX3OP1642	110	16	42	2.61	6	1.459
BPX3OP1648	117	16	48	2.61	6	1.550
BPX3OP1654	124	16	54	2.61	7	1.733
BPX3OP1660	131	16	60	2.61	7	2.006
BPX3OP1666	191	16	66	2.61	9	2.165
BPX3OP1672	249	16	72	2.61	10	2.370

**BPX3GMA • Monolithic Acoustical Panel With Embedded Glass**

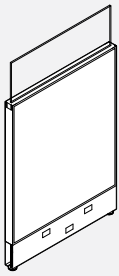

- Provides visual and acoustic privacy.
- Center septum above raceway overlaid on either side with 1 1/8" "Sound absorbent mineral board."
- Acoustic rating of .70 NRC and 25 STC.
- OPT\* = Laminate or Whiteboard
- B3 panel top trim option provided with embedded, frame-less glass pane rising 8" above the top of the panel. For instance, when installed on 42" high B3 panel, overall height will be 50" high.
- There is 1.25" gap between two adjacent glass panes.
- Glass shipped separately, Allen key to set the glass pane plumb is provided with each panel.
- 6 mm tempered glass, frosted or clear.
- Square corners on glass.
- Integrated adjustable brackets and extruded aluminum trim.
- Not retrofittable on-site.
- 16" Glass available as an option, please tag 16" and add the following upcharge per panel size.

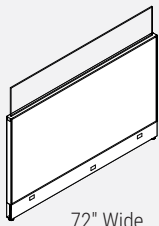

72" Wide

**UPCHARGES FOR 16" GLASS**

PANEL WIDTH	LIST
18	104
24	114
30	124
36	133
42	142
48	152
54	162
60	171
66	180
72	190

PRODUCT CODE	PRICE			SIZE / INCHES			WEIGHT VOL	
	GR1	GR2	OPT*	H	W	D	LBS	FT <sup>3</sup>
BPX3GMA3418	605	627	651	34	18	2.61	14	1.627
BPX3GMA3424	668	691	716	34	24	2.61	17	2.178
BPX3GMA3430	730	756	776	34	30	2.61	20	2.729
BPX3GMA3436	795	840	886	34	36	2.61	23	3.270
BPX3GMA3442	857	901	950	34	42	2.61	25	3.791
BPX3GMA3448	917	961	1009	34	48	2.61	29	4.302
BPX3GMA3454	977	1021	1068	34	54	2.61	32	4.853
BPX3GMA3460	1035	1076	1126	34	60	2.61	35	5.404
BPX3GMA3466	1138	1183	1237	34	66	2.61	40	6.022
BPX3GMA3472	1252	1302	-	34	72	2.61	46	6.640
BPX3GMA4218	632	663	692	42	18	2.61	15	2.072
BPX3GMA4224	696	727	756	42	24	2.61	18	2.757
BPX3GMA4230	765	795	826	42	30	2.61	22	3.442
BPX3GMA4236	829	887	950	42	36	2.61	25	4.117
BPX3GMA4242	896	956	1018	42	42	2.61	28	4.771
BPX3GMA4248	957	1015	1079	42	48	2.61	32	5.416
BPX3GMA4254	1021	1079	1140	42	54	2.61	35	6.101
BPX3GMA4260	1080	1138	1202	42	60	2.61	38	6.785
BPX3GMA4266	1187	1252	1321	42	66	2.61	44	7.558
BPX3GMA4272	1306	1377	-	42	72	2.61	50	8.330
BPX3GMA5018	746	790	840	50	18	2.61	16	2.396
BPX3GMA5024	817	862	910	50	24	2.61	20	3.178
BPX3GMA5030	895	939	986	50	30	2.61	24	3.960
BPX3GMA5036	972	1060	1155	50	36	2.61	28	4.732
BPX3GMA5042	1079	1166	1261	50	42	2.61	32	5.484
BPX3GMA5048	1118	1208	1300	50	48	2.61	35	6.226
BPX3GMA5054	1186	1275	1367	50	54	2.61	37	7.008
BPX3GMA5060	1259	1348	1441	50	60	2.61	40	7.790
BPX3GMA5066	1386	1483	1586	50	66	2.61	48	8.675
BPX3GMA5072	1524	1631	-	50	72	2.61	56	9.560
BPX3GMA5418	810	854	902	54	18	2.61	16	2.704
BPX3GMA5424	885	928	977	54	24	2.61	21	3.678
BPX3GMA5430	949	992	1038	54	30	2.61	26	4.560
BPX3GMA5436	1046	1133	1227	54	36	2.61	30	5.332
BPX3GMA5442	1122	1209	1304	54	42	2.61	34	7.126
BPX3GMA5448	1196	1283	1378	54	48	2.61	38	7.923
BPX3GMA5454	1264	1353	1446	54	54	2.61	41	8.423
BPX3GMA5460	1342	1431	1523	54	60	2.61	47	9.219
BPX3GMA6618	832	902	983	66	18	2.61	17	3.045
BPX3GMA6624	905	979	1057	66	24	2.61	22	4.021
BPX3GMA6630	986	1059	1140	66	30	2.61	27	4.997
BPX3GMA6636	1068	1183	1310	66	36	2.61	32	5.964
BPX3GMA6642	1145	1264	1387	66	42	2.61	35	6.910
BPX3GMA6648	1220	1340	1463	66	48	2.61	39	7.847
BPX3GMA6654	1291	1410	1534	66	54	2.61	42	8.823
BPX3GMA6660	1367	1486	1610	66	60	2.61	45	9.799

**BPX3GMG • Monolithic Glazed Panel With Embedded Glass**

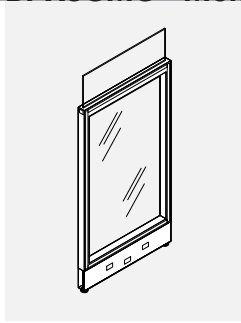

- Full-height glazing provides visual accessibility.
- Glazing is replaceable on site. Tempered clear glass standard.
- B3 panel top trim option provided with embedded, frame-less glass pane rising 8" above the top of the panel. For instance, when installed on 42" high B3 panel, overall height will be 50" high.
- There is 1.25" gap between two adjacent glass panes.
- Glass shipped separately, Allen key to set the glass pane plumb is provided with each panel.
- 6 mm tempered glass, frosted or clear.
- Square corners on glass.
- Integrated adjustable brackets and extruded aluminum trim.
- Not retrofitable on-site.

PRODUCT CODE	PRICE	FRST	SIZE / INCHES			WEIGHT VOL	
			H	W	D	LBS	FT <sup>3</sup>
BPX3GMG5024	1148	1326	50	24	2.61	30	3.178
BPX3GMG5030	1414	1640	50	30	2.61	36	3.960
BPX3GMG5036	1504	1743	50	36	2.61	41	4.732
BPX3GMG5042	1591	1842	50	42	2.61	45	5.484
BPX3GMG5048	1677	1942	50	48	2.61	52	6.226
BPX3GMG5424	1148	1326	54	24	2.61	32	3.678
BPX3GMG5430	1414	1640	54	30	2.61	40	4.360
BPX3GMG5436	1504	1743	54	36	2.61	46	5.317
BPX3GMG5442	1591	1842	54	42	2.61	52	6.010
BPX3GMG5448	1677	1942	54	48	2.61	56	6.890
BPX3GMG6624	1365	1587	66	24	2.61	38	4.021
BPX3GMG6630	1486	1727	66	30	2.61	46	4.997
BPX3GMG6636	1607	1866	66	36	2.61	52	5.964
BPX3GMG6642	1723	2003	66	42	2.61	58	6.910
BPX3GMG6648	1836	2133	66	48	2.61	65	7.847

**BPX3GPT • Pass-Thru Panel With Embedded Glass - Fabric Base**

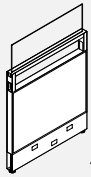

42" High

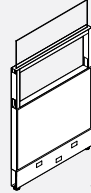

50" High

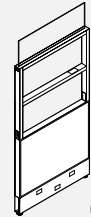

66" High

- Opening allows choice of tile above desk height.
- Solid fabric base up to 34".
- Single 8" opening above 34" for 42" high panels.
- Single 16" opening above 34" for 50" high panels.
- Two individual 16" openings above 34" for 66" high panels.
- Horizontal cable management at 34" height.
- OPT\* = Laminate or Whiteboard.
- B3 panel Top trim option provided with embedded, frame-less glass pane rising 8" above the top of the panel. For instance, when installed on 42" high B3 panel, overall height will be 50" high.
- There is 1.25" gap between two adjacent glass panes.
- Glass shipped separately.
- 6 mm tempered glass, frosted or clear.
- Square corners on glass.
- Integrated adjustable brackets and extruded aluminum trim.
- Not retrofittable on-site.

PRODUCT CODE	PRICE			SIZE / INCHES			WEIGHT VOL	
	GR 1	GR 2	OPT*	H	W	D	LBS	FT <sup>3</sup>
BPX3GPT4218	616	646	678	42	18	2.61	17	1.979
BPX3GPT4224	684	713	746	42	24	2.61	21	2.673
BPX3GPT4230	756	787	817	42	30	2.61	24	3.382
BPX3GPT4236	822	852	885	42	36	2.61	27	4.081
BPX3GPT4242	890	919	954	42	42	2.61	30	4.758
BPX3GPT4248	956	984	1018	42	48	2.61	34	5.426
BPX3GPT4254	1018	1048	1080	42	54	2.61	38	6.135
BPX3GPT4260	1083	1112	1145	42	60	2.61	40	6.852
BPX3GPT4266	1191	1224	1261	42	66	2.61	47	7.556
BPX3GPT4272	1310	1346	-	42	72	2.61	54	8.260
BPX3GPT5018	616	646	678	50	18	2.61	18	2.396
BPX3GPT5024	684	713	746	50	24	2.61	22	3.178
BPX3GPT5030	756	787	817	50	30	2.61	25	3.960
BPX3GPT5036	822	852	885	50	36	2.61	28	4.732
BPX3GPT5042	889	924	954	50	42	2.61	31	5.484
BPX3GPT5048	956	984	1018	50	48	2.61	35	6.226
BPX3GPT5054	1018	1048	1080	50	54	2.61	39	7.008
BPX3GPT5060	1083	1112	1145	50	60	2.61	42	7.790
BPX3GPT5066	1191	1224	1261	50	66	2.61	49	8.675
BPX3GPT5072	1310	1346	-	50	72	2.61	56	9.560
BPX3GPT6618	708	741	771	66	18	2.61	22	3.045
BPX3GPT6624	781	813	842	66	24	2.61	26	4.021
BPX3GPT6630	862	894	924	66	30	2.61	30	4.997
BPX3GPT6636	940	971	1003	66	36	2.61	33	5.964
BPX3GPT6642	1016	1049	1079	66	42	2.61	36	6.910
BPX3GPT6648	1091	1122	1154	66	48	2.61	41	7.847
BPX3GPT6654	1164	1193	1227	66	54	2.61	45	8.823
BPX3GPT6660	1238	1269	1302	66	60	2.61	49	9.799

**BPX3GPV • Pass-Thru Panel With Vertical Wire Channel and Embedded Glass - Fabric Base**

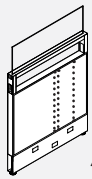

42" High

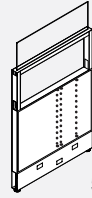

50" High

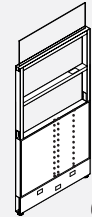

66" High

- Opening allows choice of tile above desk height. Vertical wire channel allows passage of cables from lay-in channel to bottom raceway within panel.
- Solid fabric base up to 34".
- Single 8" opening above 34" for 42" high panels.
- Single 16" opening above 34" for 50" high panels.
- Two individual 16" openings above 34" for 66" high panels.
- Includes integrated vertical wire channel.
- Horizontal cable management at 34" height.
- OPT\* = Laminate or Whiteboard.
- B3 panel Top trim option provided with embedded, frame-less glass pane rising 8" above the top of the panel. For instance, when installed on 42" high B3 panel, overall height will be 50" high.
- There is 1.25" gap between two adjacent glass panes.
- Glass shipped separately, Allen key to set the glass pane plumb is provided with each panel.
- 6 mm tempered glass, frosted or clear.
- Square corners on glass.
- Integrated adjustable brackets and extruded aluminum trim.
- Not retrofittable on-site.

PRODUCT CODE	PRICE			SIZE/INCHES			WEIGHT VOL	
	GR1	GR2	OPT*	H	W	D	LBS	FT <sup>3</sup>
BPX3GPV4230	799	830	862	42	30	2.61	26	3.382
BPX3GPV4236	868	896	930	42	36	2.61	29	4.081
BPX3GPV4242	938	966	1000	42	42	2.61	32	4.758
BPX3GPV4248	1000	1030	1062	42	48	2.61	37	5.426
BPX3GPV4254	1063	1094	1128	42	54	2.61	40	6.135
BPX3GPV4260	1129	1157	1192	42	60	2.61	43	6.852
BPX3GPV4266	1241	1274	1311	42	66	2.61	51	7.556
BPX3GPV4272	1365	1402	-	42	72	2.61	58	8.260
BPX3GPV5030	799	830	862	50	30	2.61	27	3.960
BPX3GPV5036	868	896	930	50	36	2.61	30	4.732
BPX3GPV5042	938	966	1000	50	42	2.61	33	5.484
BPX3GPV5048	1000	1030	1062	50	48	2.61	37	6.226
BPX3GPV5054	1063	1094	1128	50	54	2.61	41	7.008
BPX3GPV5060	1129	1157	1192	50	60	2.61	44	7.790
BPX3GPV5066	1241	1274	1311	50	66	2.61	52	8.675
BPX3GPV5072	1365	1402	-	50	72	2.61	60	9.560
BPX3GPV6630	908	939	970	66	30	2.61	32	4.997
BPX3GPV6636	984	1016	1049	66	36	2.61	35	5.964
BPX3GPV6642	1063	1095	1126	66	42	2.61	38	6.910
BPX3GPV6648	1138	1169	1202	66	48	2.61	43	7.847
BPX3GPV6654	1209	1238	1273	66	54	2.61	47	8.823
BPX3GPV6660	1280	1311	1343	66	60	2.61	51	9.799

**BPX3GPF • Pass-Thru Panel With Embedded Glass - Air Flow Base**

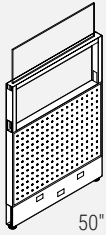

50" High

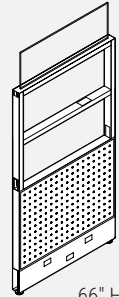

66" High

- Allows air to flow freely through the bottom of the panel.
- Double wall perforated metal base up to 34".
- Single 16" opening above 34" for 50" high panels.
- Two individual 16" openings above 34" for 66" high panels.
- Horizontal cable management at 34" height.
- B3 panel Top trim option provided with embedded, frame-less glass pane rising 8" above the top of the panel. For instance, when installed on 42" high B3 panel, overall height will be 50" high.
- There is 1.25" gap between two adjacent glass panes.
- Glass shipped separately, Allen key to set the glass pane plumb is provided with each panel.
- 6 mm tempered glass, frosted or clear.
- Square corners on glass.
- Integrated adjustable brackets and extruded aluminum trim.
- Not retrofiteable on-site.

PRODUCT CODE	PRICE	SIZE / INCHES			WEIGHT VOL	
		H	W	D	LBS	FT <sup>3</sup>
BPX3GPF5018	765	50	18	2.61	20	2.396
BPX3GPF5024	858	50	24	2.61	23	3.178
BPX3GPF5030	955	50	30	2.61	27	3.960
BPX3GPF5036	1048	50	36	2.61	30	4.732
BPX3GPF5042	1144	50	42	2.61	32	5.484
BPX3GPF5048	1234	50	48	2.61	37	6.226
BPX3GPF5054	1322	50	54	2.61	40	7.008
BPX3GPF5060	1414	50	60	2.61	44	7.790
BPX3GPF6618	854	66	18	2.61	24	3.045
BPX3GPF6624	956	66	24	2.61	28	4.021
BPX3GPF6630	1064	66	30	2.61	32	4.997
BPX3GPF6636	1171	66	36	2.61	35	5.964
BPX3GPF6642	1280	66	42	2.61	38	6.910
BPX3GPF6648	1382	66	48	2.61	43	7.847
BPX3GPF6654	1482	66	54	2.61	47	8.823
BPX3GPF6660	1585	66	60	2.61	50	9.799

**BPX3GOP • Over Panel Frame With Embedded Glass**

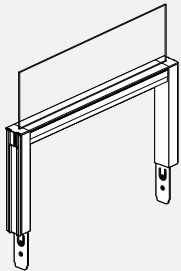

- Attaches to the top of any Boulevard System 3 panel to create a floor-to-ceiling wall.
- Any tile can be attached to either side to enclose the frame.
- Two non-slotted uprights at either end slide into vertical extrusions on the base panel.
- Shipped without horizontal and vertical trim; the horizontal trim from the base panel will be used.
- Boulevard System 3 Over Panel is not compatible with Boulevard 1 panels.
- B3 panel Top trim option provided with embedded, frame-less glass pane rising 8" above the top of the panel. For instance, when installed on 42" high B3 panel, overall height will be 50" high.
- There is 1.25" gap between two adjacent glass panes.
- Glass shipped separately, Allen key to set the glass pane plumb is provided with each panel.
- 5 mm tempered glass, frosted or clear.
- Square corners on glass.
- Integrated adjustable brackets and extruded aluminum trim.
- Not retrofiteable on-site.

PRODUCT CODE	PRICE	SIZE / INCHES			WEIGHT VOL	
		H	W	D	LBS	FT <sup>3</sup>
BPX3GOP0818	329	8	18	2.61	6	0.673
BPX3GOP0824	357	8	24	2.61	9	0.878
BPX3GOP0830	394	8	30	2.61	11	1.246
BPX3GOP0836	426	8	36	2.61	12	1.442
BPX3GOP0842	458	8	42	2.61	14	1.725
BPX3GOP0848	484	8	48	2.61	16	1.890
BPX3GOP0854	511	8	54	2.61	18	2.150
BPX3GOP0860	539	8	60	2.61	19	2.464
BPX3GOP0866	593	8	66	2.61	22	2.722
BPX3GOP0872	652	8	72	2.61	24	2.980
BPX3GOP1618	329	16	18	2.61	7	0.928
BPX3GOP1624	357	16	24	2.61	10	1.170
BPX3GOP1630	394	16	30	2.61	12	1.684
BPX3GOP1636	426	16	36	2.61	13	1.916
BPX3GOP1642	458	16	42	2.61	15	2.309
BPX3GOP1648	484	16	48	2.61	17	2.510
BPX3GOP1654	511	16	54	2.61	19	2.843
BPX3GOP1660	539	16	60	2.61	20	3.266
BPX3GOP1666	593	16	66	2.61	23	3.598
BPX3GOP1672	652	16	72	2.61	26	3.930



**BPX3TMA • Monolithic Accoustical Panel With Embedded Felt Divider**

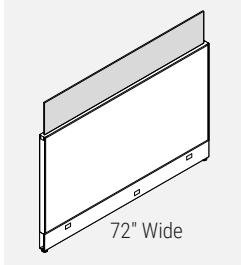
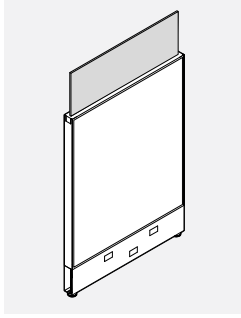

- Provides visual and acoustic privacy
- B3 panel top trim option provided with embedded, frame-less felt panel rising 8" or 16" above the top of the panel. For instance, when installed on 42" high B3 panel, overall height will be 50" high for 8" and 58" high for 16".
- There is 1.25" gap between two adjacent felt panels.
- Felt panel shipped separately.
- 9 mm Felt material is tackable and comes in 18 different colors. Please specify color.
- NOTE: List price shown is for 8" high felt only.

PRODUCT CODE	PRICE			SIZE/INCHES			WEIGHT VOL	
	GR1	GR2	OPT*	H	W	D	LBS	FT <sup>3</sup>
BPX3TMA3418	563	592	622	34	18	2.61	11.9	1.627
BPX3TMA3424	630	657	689	34	24	2.61	14.1	2.178
BPX3TMA3430	696	724	754	34	30	2.61	16.3	2.729
BPX3TMA3436	761	819	879	34	36	2.61	18.5	3.270
BPX3TMA3442	832	889	950	34	42	2.61	19.7	3.791
BPX3TMA3448	897	955	1015	34	48	2.61	22.8	4.302
BPX3TMA3454	978	1033	1094	34	54	2.61	25.0	4.853
BPX3TMA3460	1042	1099	1161	34	60	2.61	27.2	5.404
BPX3TMA3466	1107	1186	1273	34	66	2.61	31.4	6.022
BPX3TMA3472	1170	1248	-	34	72	2.61	36.6	6.640
BPX3TMA4218	600	638	679	42	18	2.61	12.9	2.072
BPX3TMA4224	670	709	750	42	24	2.61	15.1	2.757
BPX3TMA4230	740	778	819	42	30	2.61	18.3	3.442
BPX3TMA4236	809	885	966	42	36	2.61	20.5	4.117
BPX3TMA4242	883	960	1041	42	42	2.61	22.7	4.771
BPX3TMA4248	955	1031	1112	42	48	2.61	25.8	5.416
BPX3TMA4254	1033	1111	1192	42	54	2.61	28.0	6.101
BPX3TMA4260	1101	1178	1259	42	60	2.61	30.2	6.785
BPX3TMA4266	1207	1361	1531	42	66	2.61	35.4	7.558
BPX3TMA4272	1308	1466	-	42	72	2.61	40.6	8.330
BPX3TMA5018	752	809	870	50	18	2.61	13.9	2.396
BPX3TMA5024	835	891	952	50	24	2.61	17.1	3.178
BPX3TMA5030	922	977	1037	50	30	2.61	20.3	3.960
BPX3TMA5036	1000	1115	1238	50	36	2.61	23.5	4.732
BPX3TMA5042	1087	1202	1324	50	42	2.61	26.7	5.484
BPX3TMA5048	1170	1284	1408	50	48	2.61	28.8	6.226
BPX3TMA5054	1262	1375	1497	50	54	2.61	30.0	7.008
BPX3TMA5060	1346	1461	1583	50	60	2.61	32.2	7.790
BPX3TMA5066	1457	1613	1780	50	66	2.61	39.4	8.675
BPX3TMA5072	1564	1721	-	50	72	2.61	46.6	9.560
BPX3TMA5418	782	837	900	54	18	2.61	13.9	2.704
BPX3TMA5424	864	922	982	54	24	2.61	18.1	3.678
BPX3TMA5430	950	1009	1069	54	30	2.61	22.3	4.560
BPX3TMA5436	1033	1148	1272	54	36	2.61	25.5	5.332
BPX3TMA5442	1122	1236	1360	54	42	2.61	28.7	7.126
BPX3TMA5448	1204	1317	1442	54	48	2.61	31.8	7.923
BPX3TMA5454	1297	1410	1534	54	54	2.61	34.0	8.423
BPX3TMA5460	1383	1497	1620	54	60	2.61	39.2	9.219
BPX3TMA6618	868	964	1065	66	18	2.61	14.9	3.045
BPX3TMA6624	959	1053	1156	66	24	2.61	19.1	4.021
BPX3TMA6630	1041	1137	1237	66	30	2.61	23.3	4.997
BPX3TMA6636	1130	1283	1445	66	36	2.61	27.5	5.964
BPX3TMA6642	1223	1375	1538	66	42	2.61	29.7	6.910
BPX3TMA6648	1308	1462	1624	66	48	2.61	32.8	7.847
BPX3TMA6654	1405	1558	1720	66	54	2.61	35.0	8.823
BPX3TMA6660	1495	1647	1810	66	60	2.61	37.2	9.799

**BPX3TMG • Monolithic Glazed Panel With Embedded Felt Divider**

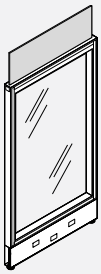

- Full-height glazing provides visual accessibility.
- B3 panel top trim option provided with embedded, frame-less felt panel rising 8" or 16" above the top of the panel. For instance, when installed on 42" high B3 panel, overall height will be 50" high for 8" and 58" high for 16".
- There is 1.25" gap between two adjacent felt panels.
- Felt panel shipped separately.
- 9 mm Felt material is tackable and comes in 18 different colors. Please specify color.
- NOTE: List price shown is for 8" high felt only.

PRODUCT CODE	PRICE	FRST	SIZE/INCHES			WEIGHT VOL	
			H	W	D	LBS	FT <sup>3</sup>
BPX3TMG5024	1288	1529	50	24	2.61	27.1	3.178
BPX3TMG5030	1624	1928	50	30	2.61	32.3	3.960
BPX3TMG5036	1726	2050	50	36	2.61	36.5	4.732
BPX3TMG5042	1830	2174	50	42	2.61	39.7	5.484
BPX3TMG5048	1932	2292	50	48	2.61	45.8	6.226
BPX3TMG5424	1365	1621	54	24	2.61	29.1	3.678
BPX3TMG5430	1651	1961	54	30	2.61	36.3	4.360
BPX3TMG5436	1763	2095	54	36	2.61	41.5	5.317
BPX3TMG5442	1874	2228	54	42	2.61	46.7	6.010
BPX3TMG5448	1986	2359	54	48	2.61	49.8	6.890
BPX3TMG6624	1583	1887	66	24	2.61	35.1	4.021
BPX3TMG6630	1723	2051	66	30	2.61	42.3	4.997
BPX3TMG6636	1872	2227	66	36	2.61	47.5	5.964
BPX3TMG6642	2012	2390	66	42	2.61	52.7	6.910
BPX3TMG6648	2150	2555	66	48	2.61	58.8	7.847

**BPX3TPT • Pass-Thru Panel With Embedded Felt Divider**

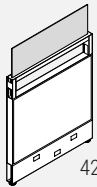

42" High

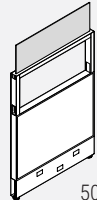

50" High

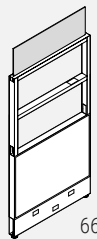

66" High

- Opening allows choice of tile above desk height.
- B3 panel top trim option provided with embedded, frame-less felt panel rising 8" or 16" above the top of the panel. For instance, when installed on 42" high B3 panel, overall height will be 50" high for 8" and 58" high for 16".
- There is 1.25" gap between two adjacent felt panels.
- Felt panel shipped separately.
- 9 mm Felt material is tackable and comes in 18 different colors. Please specify color.
- NOTE: List price shown is for 8" high felt only.

PRODUCT CODE	PRICE			SIZE/INCHES			WEIGHT VOL	
	GR 1	GR 2	OPT*	H	W	D	LBS	FT <sup>3</sup>
BPX3TPT4218	577	615	658	42	18	2.61	17	1.979
BPX3TPT4224	653	692	734	42	24	2.61	21	2.673
BPX3TPT4230	727	765	808	42	30	2.61	24	3.382
BPX3TPT4236	798	836	879	42	36	2.61	27	4.081
BPX3TPT4242	873	911	954	42	42	2.61	30	4.758
BPX3TPT4248	949	988	1031	42	48	2.61	34	5.426
BPX3TPT4254	1032	1070	1113	42	54	2.61	38	6.135
BPX3TPT4260	1102	1142	1183	42	60	2.61	40	6.852
BPX3TPT4266	1180	1259	1346	42	66	2.61	47	7.556
BPX3TPT4272	1257	1335	-	42	72	2.61	54	8.260
BPX3TPT5018	577	615	658	50	18	2.61	18	2.396
BPX3TPT5024	653	692	734	50	24	2.61	22	3.178
BPX3TPT5030	727	765	808	50	30	2.61	25	3.960
BPX3TPT5036	798	836	879	50	36	2.61	28	4.732
BPX3TPT5042	873	911	954	50	42	2.61	31	5.484
BPX3TPT5048	949	988	1031	50	48	2.61	35	6.226
BPX3TPT5054	1032	1070	1113	50	54	2.61	39	7.008
BPX3TPT5060	1102	1142	1183	50	60	2.61	42	7.790
BPX3TPT5066	1180	1259	1346	50	66	2.61	49	8.675
BPX3TPT5072	1257	1335	-	50	72	2.61	56	9.560
BPX3TPT6618	669	709	750	66	18	2.61	22	3.045
BPX3TPT6624	757	798	838	66	24	2.61	26	4.021
BPX3TPT6630	848	889	929	66	30	2.61	30	4.997
BPX3TPT6636	933	973	1014	66	36	2.61	33	5.964
BPX3TPT6642	1024	1064	1105	66	42	2.61	36	6.910
BPX3TPT6648	1117	1157	1198	66	48	2.61	41	7.847
BPX3TPT6654	1216	1257	1297	66	54	2.61	45	8.823
BPX3TPT6660	1307	1348	1388	66	60	2.61	49	9.799

**BPX3TPV • Pass-Thru Panel With Vertical Wire Channel and Embedded Felt Divider - Fabric Base**

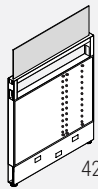

42" High

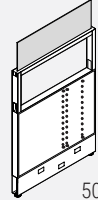

50" High

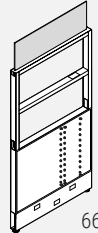

66" High

- Opening allows choice of tile above desk height. Vertical wire channel allows passage of cables from lay-in channel to bottom raceway within panel.
- B3 panel top trim option provided with embedded, frame-less felt panel rising 8" or 16" above the top of the panel. For instance, when installed on 42" high B3 panel, overall height will be 50" high for 8" and 58" high for 16".
- There is 1.25" gap between two adjacent felt panels.
- Felt panel shipped separately.
- 9 mm Felt material is tackable and comes in 18 different colors. Please specify color.
- NOTE: List price shown is for 8" high felt only.

PRODUCT CODE	PRICE			SIZE / INCHES			WEIGHT VOL	
	GR 1	GR 2	OPT*	H	W	D	LBS	FT <sup>3</sup>
BPX3TPV4230	787	825	868	42	30	2.61	22.3	3.382
BPX3TPV4236	859	898	940	42	36	2.61	24.5	4.081
BPX3TPV4242	938	977	1020	42	42	2.61	26.7	4.758
BPX3TPV4248	1011	1049	1092	42	48	2.61	30.8	5.426
BPX3TPV4254	1090	1128	1171	42	54	2.61	33.0	6.135
BPX3TPV4260	1172	1211	1253	42	60	2.61	35.2	6.852
BPX3TPV4266	1235	1313	1400	42	66	2.61	42.4	7.556
BPX3TPV4272	1297	1376	-	42	72	2.61	48.6	8.260
BPX3TPV5030	787	825	868	50	30	2.61	23.3	3.960
BPX3TPV5036	859	898	940	50	36	2.61	25.5	4.732
BPX3TPV5042	938	977	1020	50	42	2.61	27.7	5.484
BPX3TPV5048	1011	1049	1092	50	48	2.61	30.8	6.226
BPX3TPV5054	1090	1128	1171	50	54	2.61	34.0	7.008
BPX3TPV5060	1172	1211	1253	50	60	2.61	36.2	7.790
BPX3TPV5066	1235	1313	1400	50	66	2.61	43.4	8.675
BPX3TPV5072	1297	1376	-	50	72	2.61	50.6	9.560
BPX3TPV6630	935	976	1016	66	30	2.61	28.3	4.997
BPX3TPV6636	1024	1064	1105	66	36	2.61	30.5	5.964
BPX3TPV6642	1108	1149	1189	66	42	2.61	32.7	6.910
BPX3TPV6648	1194	1236	1277	66	48	2.61	36.8	7.847
BPX3TPV6654	1289	1329	1370	66	54	2.61	40.0	8.823
BPX3TPV6660	1377	1418	1458	66	60	2.61	43.2	9.799

**BPX3TPF • Pass-Thru Panel With Embedded Felt Divider - Air Flow Base**

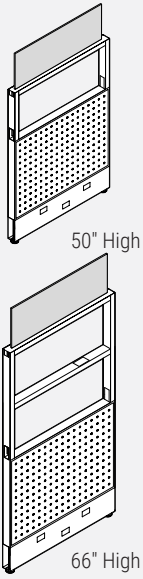

- Allows air to flow freely through the bottom of the panel.
- B3 panel top trim option provided with embedded, frameless felt panel rising 8" or 16" above the top of the panel. For instance, when installed on 42" high B3 panel, overall height will be 50" high for 8" and 58" high for 16".
- There is 1.25" gap between two adjacent felt panels.
- Felt panel shipped separately.
- 9 mm Felt material is tackable and comes in 18 different colors. Please specify color.
- NOTE: List price shown is for 8" high felt only.

PRODUCT CODE	PRICE	SIZE / INCHES			WEIGHT VOL	
		H	W	D	LBS	FT <sup>3</sup>
BPX3TPF5018	783	50	18	2.61	17.9	2.396
BPX3TPF5024	889	50	24	2.61	20.1	3.178
BPX3TPF5030	993	50	30	2.61	23.3	3.960
BPX3TPF5036	1107	50	36	2.61	25.5	4.732
BPX3TPF5042	1219	50	42	2.61	26.7	5.484
BPX3TPF5048	1328	50	48	2.61	30.8	6.226
BPX3TPF5054	1446	50	54	2.61	33.0	7.008
BPX3TPF5060	1553	50	60	2.61	36.2	7.790
BPX3TPF6618	905	66	18	2.61	21.9	3.045
BPX3TPF6624	1022	66	24	2.61	25.1	4.021
BPX3TPF6630	1151	66	30	2.61	28.3	4.997
BPX3TPF6636	1275	66	36	2.61	30.5	5.964
BPX3TPF6642	1404	66	42	2.61	32.7	6.910
BPX3TPF6648	1529	66	48	2.61	36.8	7.847
BPX3TPF6654	1662	66	54	2.61	40.0	8.823
BPX3TPF6660	1788	66	60	2.61	42.2	9.799

**BPX3TOP • Over Panel Frame With Embedded Felt Divider**

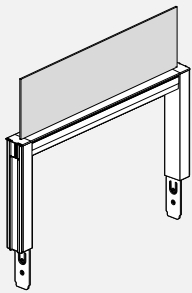

- Attaches to the top of any Boulevard System 3 panel to create a floor-to-ceiling wall
- B3 panel top trim option provided with embedded, frameless felt panel rising 8" or 16" above the top of the panel. For instance, when installed on 42" high B3 panel, overall height will be 50" high for 8" and 58" high for 16".
- There is 1.25" gap between two adjacent felt panels.
- Felt panel shipped separately.
- 9 mm Felt material is tackable and comes in 18 different colors. Please specify color.

PRODUCT CODE	PRICE	SIZE / INCHES			WEIGHT VOL	
		H	W	D	LBS	FT <sup>3</sup>
BPX3TOP0818	190	8	18	2.61	3.9	0.673
BPX3TOP0824	211	8	24	2.61	6.1	0.878
BPX3TOP0830	233	8	30	2.61	7.3	1.246
BPX3TOP0836	258	8	36	2.61	7.5	1.442
BPX3TOP0842	285	8	42	2.61	8.7	1.725
BPX3TOP0848	308	8	48	2.61	9.8	1.890
BPX3TOP0854	340	8	54	2.61	11.0	2.150
BPX3TOP0860	365	8	60	2.61	11.2	2.464
BPX3TOP0866	401	8	66	2.61	13.4	2.722
BPX3TOP0872	433	8	72	2.61	14.6	2.980
BPX3TOP1618	190	16	18	2.61	4.9	0.928
BPX3TOP1624	211	16	24	2.61	7.1	1.170
BPX3TOP1630	233	16	30	2.61	8.3	1.684
BPX3TOP1636	258	16	36	2.61	8.5	1.916
BPX3TOP1642	285	16	42	2.61	9.7	2.309
BPX3TOP1648	308	16	48	2.61	10.8	2.510
BPX3TOP1654	340	16	54	2.61	12.0	2.843
BPX3TOP1660	365	16	60	2.61	12.2	3.266
BPX3TOP1666	401	16	66	2.61	14.4	3.598
BPX3TOP1672	433	16	72	2.61	16.6	3.930

**BP3DS • Solid Door Panel**

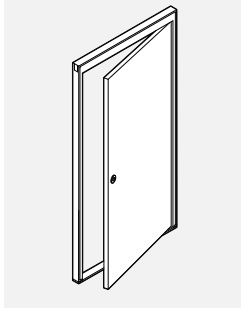

- Aluminum frame with either high pressure laminate door.
- 1 3/8" thick hollow core door.
- Actual door size:
  - 79.9" x 32 1/2" in 82" x 36" frame
  - 79.9" x 38 1/2" in 82" x 42" frame
- 42" wide Door Panel permits wheelchair accessibility.
- No hang-on capabilities.
- 180 degree swing.
- Specify Door Knob (DL01) or Door Lever (DL02).
- Lock standard.
- Handedness can be changed on site.
- Please specify Right hand (R) or Left hand (L) hung.
- Includes a Horizontal Lay-in Channel.

PRODUCT CODE	PRICE HP	SIZE/INCHES			WEIGHT VOL	
		H	W	D	LBS	FT <sup>3</sup>
BP3DS8236R	2078	82	36	2.61	61	6.465
BP3DS8242R	2263	82	42	2.61	68	7.486
BP3DS8236L	2078	82	36	2.61	61	6.465
BP3DS8242L	2263	82	42	2.61	68	7.486

**Door Hanging Directions**



Right Shown



Left Shown

**Door Handle Option**

Door Knob - DL01  
• Lock Standard



Door Lever - DL02 (Default)

Lock Standard

Lever complies with all accessibility standards



**BP3DH • Half-Glazed Door Panel**

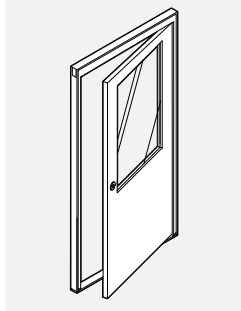

- Aluminum frame with either high pressure laminate door and window.
- 1 3/8" thick hollow core door.
- Actual door size:
  - 79.9" x 32 1/2" in 82" x 36" frame
  - 79.9" x 38 1/2" in 82" x 42" frame
- 42" wide Door Panel permits wheelchair accessibility.
- No hang-on capabilities.
- 180 degree swing.
- Specify Door Knob (DL01) or Door Lever (DL02).
- Lock standard.
- Handedness can be changed on site.
- Please specify Right hand (R) or Left hand (L) hung.
- Includes a Horizontal Lay-in Channel.

PRODUCT CODE	PRICE HP	SIZE/INCHES			WEIGHT VOL	
		H	W	D	LBS	FT <sup>3</sup>
BP3DH8236R	2573	82	36	2.61	53	6.465
BP3DH8242R	2814	82	42	2.61	59	7.486
BP3DH8236L	2573	82	36	2.61	53	6.465
BP3DH8242L	2814	82	42	2.61	59	7.486

**Door Hanging Directions**



Right Shown



Left Shown

**Door Handle Option**

Door Knob - DL01  
• Lock Standard



Door Lever - DL02 (Default)

Lock Standard

Lever complies with all accessibility standards



**BP3DG • Full-Glazed Door Panel**

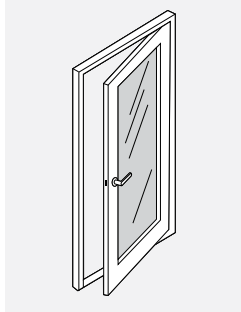

- Aluminum frame with either high pressure laminate door and window.
- 1 3/8" thick hollow core door.
- Actual door size:
  - 79.9" x 32 1/2" in 82" x 36" frame
  - 79.9" x 38 1/2" in 82" x 42" frame
- 42" wide Door Panel permits wheelchair accessibility.
- No hang-on capabilities.
- 180 degree swing.
- Specify Door Knob (DL01) or Door Lever (DL02).
- Lock standard.
- Handedness can be changed on site.
- Please specify Right hand (R) or Left hand (L) hung.
- Includes a Horizontal Lay-in Channel.
- Laminate frame is 5" thick at the sides and 4" at the top and bottom.

PRODUCT CODE	PRICE HP	SIZE/INCHES			WEIGHT VOL	
		H	W	D	LBS	FT <sup>3</sup>
BP3DG8236R	4120	82	36	2.61	53	6.465
BP3DG8242R	4507	82	42	2.61	59	7.486
BP3DG8236L	4120	82	36	2.61	53	6.465
BP3DG8242L	4507	82	42	2.61	59	7.486

**Door Hanging Directions**

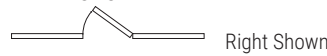

Right Shown

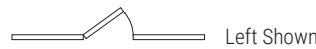

Left Shown

**Door Handle Option**

Door Knob - DL01  
• Lock Standard



Door Lever - DL02 (Default)

Lock Standard

Lever complies with all accessibility standards



**BPX3NET • Removable Face Tile - Electrical Tile Kit**

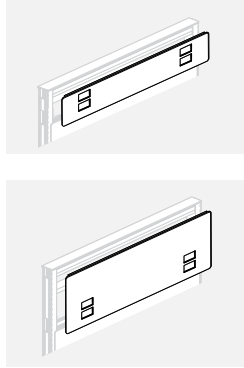

- Attaches to an 8" or 16" opening in a Pass-Thru Panel.
- Fabric covered tile with knock-out for power and data. (Data/Comm blank covers included).
- 24" wide tiles have one duplex and one data/comm opening. 30" and wider tiles have two duplex and two data/comm openings.
- Easily interchangeable on site.
- Provides access to electrical and data at a required location.
- Specify Tile Electrical Kit separately.
- Duplexes and covers must be specified separately.
- For power outlets on both sides of the panel, specify two Electrical Tiles per panel. For power outlets on one side only, specify one Electrical Tile and a Fabric Tile for the opposite side.
- OPT\* = Laminate or Whiteboard.
- For use on panels manufactured after November 1, 2014

PRODUCT CODE	PRICE			SIZE/INCHES			WEIGHT VOL	
	GR1	GR2	OPT*	H	W	D	LBS	FT <sup>3</sup>
BPX3NET0824	118	124	130	8	24	0.125	2.0	0.170
BPX3NET0830	188	201	215	8	30	0.125	2.5	0.200
BPX3NET0836	211	222	237	8	36	0.125	2.5	0.250
BPX3NET0842	218	230	247	8	42	0.125	2.5	0.292
BPX3NET0848	223	236	252	8	48	0.125	3.0	0.333
BPX3NET0854	231	245	259	8	54	0.125	3.0	0.375
BPX3NET0860	237	250	264	8	60	0.125	4.5	0.417
BPX3NET0866	339	392	448	8	66	0.125	4.7	0.475
BPX3NET0872	438	492	-	8	72	0.125	5.0	0.500
BPX3NET1624	118	124	130	16	24	0.125	2.5	3.400
BPX3NET1630	188	201	215	16	30	0.125	3.0	0.416
BPX3NET1636	211	222	237	16	36	0.125	3.0	0.500
BPX3NET1642	218	230	247	16	42	0.125	3.0	0.583
BPX3NET1648	223	236	252	16	48	0.125	4.0	0.666
BPX3NET1654	231	245	259	16	54	0.125	4.0	0.750
BPX3NET1660	237	250	264	16	60	0.125	5.0	0.833
BPX3NET1666	339	392	448	16	66	0.125	5.5	0.911
BPX3NET1672	438	492	-	16	72	0.125	6.0	1.000

**BP3GT • Removable Face Tile - Glazed**

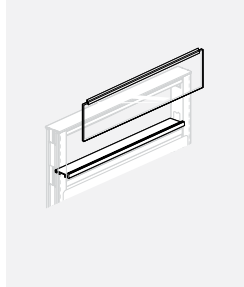

- Attaches to any opening in a Pass-Thru Panel.
- 8" or 16" high glazing provides visual accessibility and light transfer.
- Easily interchangeable on site.
- Specify one Glazed Tile for panel opening of corresponding width.
- Clear tempered glass standard.

PRODUCT CODE	PRICE	FRST	SIZE/INCHES			WEIGHT VOL	
			H	W	D	LBS	FT <sup>3</sup>
BP3GT0818	72	98	8	18	2.61	2.3	0.146
BP3GT0824	96	123	8	24	2.61	3.1	0.165
BP3GT0830	122	149	8	30	2.61	3.9	0.200
BP3GT0836	149	174	8	36	2.61	4.7	0.250
BP3GT0842	172	200	8	42	2.61	5.5	0.292
BP3GT0848	200	225	8	48	2.61	6.3	0.333
BP3GT0854	222	250	8	54	2.61	7.1	0.375
BP3GT0860	250	276	8	60	2.61	7.8	0.417
BP3GT0866	356	383	8	66	2.61	8.6	0.460
BP3GT0872	464	490	8	72	2.61	9.4	0.500
BP3GT1618	72	98	16	18	2.61	4.3	0.292
BP3GT1624	96	123	16	24	2.61	5.8	0.333
BP3GT1630	122	149	16	30	2.61	7.2	0.416
BP3GT1636	149	174	16	36	2.61	8.7	0.500
BP3GT1642	172	200	16	42	2.61	10.2	0.583
BP3GT1648	200	225	16	48	2.61	11.6	0.666
BP3GT1654	222	250	16	54	2.61	13.1	0.750
BP3GT1660	250	276	16	60	2.61	14.6	0.833
BP3GT1666	356	383	16	66	2.61	16.0	0.911
BP3GT1672	464	490	16	72	2.61	17.5	1.000

**BPX3ETCS Removable Face Tile - Chicago Electrical Tile Kit - Single Punch**

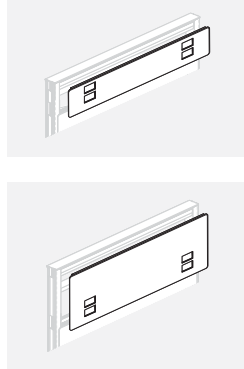

- Attaches to an 8" or 16" opening in Pass-Thru panel.
- Fabric covered tile with single knock-out for power.
- Easily interchangeable on site.
- Provides access to electrical and data at a required location.
- Specify Chicago Electrical Kit separately.
- Duplexes and covers must be specified separately.
- OPT\* = Laminate or Whiteboard.
- For use on Panels manufactured after November 1, 2014.

PRODUCT CODE	PRICE			SIZE/INCHES			WEIGHT VOL	
	GR1	GR2	OPT*	H	W	D	LBS	FT <sup>3</sup>
BPX3ETCS0824	125	133	139	8	24	0.125	2	0.170
BPX3ETCS0830	203	214	230	8	30	0.125	2.5	0.200
BPX3ETCS0836	225	238	253	8	36	0.125	2.5	0.250
BPX3ETCS0842	234	247	263	8	42	0.125	2.5	0.292
BPX3ETCS0848	239	252	268	8	48	0.125	3	0.333
BPX3ETCS0854	248	261	277	8	54	0.125	3	0.375
BPX3ETCS0860	253	266	282	8	60	0.125	4.5	0.417
BPX3ETCS0866	362	419	477	8	66	0.125	4.7	0.475
BPX3ETCS0872	469	525	585	8	72	0.125	5	0.500
BPX3ETCS1624	125	133	139	16	24	0.125	2	0.400
BPX3ETCS1630	203	214	230	16	30	0.125	2.5	0.416
BPX3ETCS1636	225	238	253	16	36	0.125	2.5	0.500
BPX3ETCS1642	234	247	263	16	42	0.125	2.5	0.583
BPX3ETCS1648	239	252	268	16	48	0.125	3	0.666
BPX3ETCS1654	248	261	277	16	54	0.125	3	0.750
BPX3ETCS1660	253	266	282	16	60	0.125	4.5	0.833
BPX3ETCS1666	362	419	477	16	66	0.125	4.7	0.911
BPX3ETCS1672	469	525	585	16	72	0.125	5	1.000

**BPX3ETCS Removable Face Tile - Chicago Electrical Tile Kit - Double Punch**

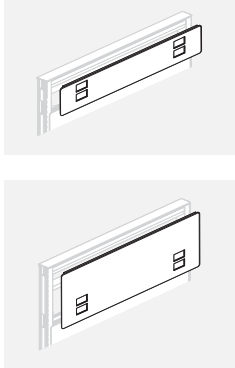

- Attaches to an 8" or 16" opening in Pass-Thru panel.
- Fabric covered tile with double knock-out for power.
- Easily interchangeable on site.
- Provides access to electrical and data at a required location.
- Specify Chicago Electrical Kit separately.
- Duplexes and covers must be specified separately.
- OPT\* = Laminate or Whiteboard.
- For use on Panels manufactured after November 1, 2014.

PRODUCT CODE	PRICE			SIZE/INCHES			WEIGHT VOL	
	GR 1	GR 2	OPT*	H	W	D	LBS	FT <sup>3</sup>
BPX3ETCD0824	136	144	152	8	24	0.125	2	0.170
BPX3ETCD0830	220	234	250	8	30	0.125	2.5	0.200
BPX3ETCD0836	245	259	276	8	36	0.125	2.5	0.250
BPX3ETCD0842	255	268	287	8	42	0.125	2.5	0.292
BPX3ETCD0848	260	275	293	8	48	0.125	3	0.333
BPX3ETCD0854	270	286	302	8	54	0.125	3	0.375
BPX3ETCD0860	276	291	308	8	60	0.125	4.5	0.417
BPX3ETCD0866	394	457	522	8	66	0.125	4.7	0.475
BPX3ETCD0872	511	574	638	8	72	0.125	5	0.500
BPX3ETCD1624	136	144	152	16	24	0.125	2	0.400
BPX3ETCD1630	220	234	250	16	30	0.125	2.5	0.416
BPX3ETCD1636	245	259	276	16	36	0.125	2.5	0.500
BPX3ETCD1642	255	268	287	16	42	0.125	2.5	0.583
BPX3ETCD1648	260	275	293	16	48	0.125	3	0.666
BPX3ETCD1654	270	286	302	16	54	0.125	3	0.750
BPX3ETCD1660	276	291	308	16	60	0.125	4.5	0.833
BPX3ETCD1666	394	457	522	16	66	0.125	4.7	0.911
BPX3ETCD1672	511	574	638	16	72	0.125	5	1.000

**BP3DGT • Removable Face Tile - Double Glazed**

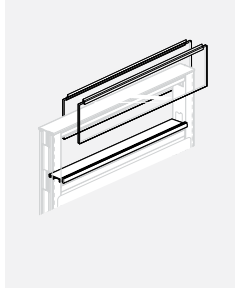

- Attaches to any opening in a Pass-Thru Panel.
- 8" or 16" high glazing provides visual accessibility and light transfer.
- Easily interchangeable on site.
- Specify one Double Glazed Tile for panel opening of corresponding width.
- Clear tempered glass standard.

PRODUCT CODE	PRICE	FRST	SIZE/INCHES			WEIGHT VOL	
			H	W	D	LBS	FT <sup>3</sup>
BP3DGT0818	182	216	8	18	2.61	6.0	0.292
BP3DGT0824	243	288	8	24	2.61	8.2	0.330
BP3DGT0830	307	365	8	30	2.61	10.4	0.400
BP3DGT0836	376	448	8	36	2.61	12.6	0.500
BP3DGT0842	436	523	8	42	2.61	14.7	0.584
BP3DGT0848	501	603	8	48	2.61	16.9	0.666
BP3DGT0854	565	679	8	54	2.61	19.0	0.750
BP3DGT0860	630	755	8	60	2.61	21.3	0.834
BP3DGT0866	693	831	8	66	2.61	23.4	0.920
BP3DGT0872	755	907	8	72	2.61	25.6	1.000
BP3DGT1618	212	254	16	18	2.61	10.0	0.584
BP3DGT1624	285	341	16	24	2.61	13.6	0.666
BP3DGT1630	361	432	16	30	2.61	17.1	0.832
BP3DGT1636	439	528	16	36	2.61	20.6	1.000
BP3DGT1642	512	615	16	42	2.61	24.1	1.166
BP3DGT1648	588	706	16	48	2.61	27.7	1.322
BP3DGT1654	664	797	16	54	2.61	31.2	1.500
BP3DGT1660	740	887	16	60	2.61	34.7	1.666
BP3DGT1666	815	937	16	66	2.61	38.2	1.822
BP3DGT1672	887	1020	16	72	2.61	41.7	2.000

**BP30T • Removable Face Tile - Open Pass-Thru Kit**

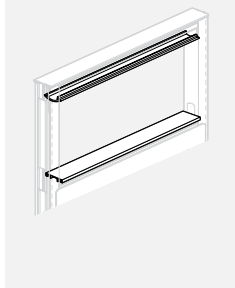

- Attaches to any opening in a Pass-Thru Panel.
- Trims and internal corners included to create an opening.
- Easily interchangeable on site.
- Specify one Pass-Thru Kit for panel opening of corresponding width.
- Kit works for 8" & 16" openings.
- Please specify panel frame color.

PRODUCT CODE	PRICE	SIZE/INCHES			WEIGHT VOL	
		H	W	D	LBS	FT <sup>3</sup>
BP30T1618	10	16	18	2.61	0.4	0.292
BP30T1624	12	16	24	2.61	0.6	0.333
BP30T1630	15	16	30	2.61	0.8	0.416
BP30T1636	25	16	36	2.61	1.0	0.500
BP30T1642	28	16	42	2.61	1.1	0.583
BP30T1648	32	16	48	2.61	1.3	0.666
BP30T1654	34	16	54	2.61	1.5	0.750
BP30T1660	38	16	60	2.61	1.7	0.833
BP30T1666	53	16	66	2.61	1.9	0.911
BP30T1672	70	16	72	2.61	2.0	1.000

**BP3AT • Removable Face Tile - Accessory**

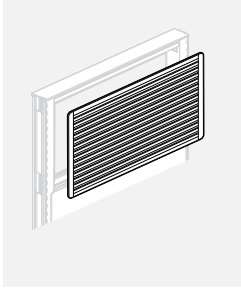

- Attaches to any opening in a Pass-Thru Panel.
- Provides support for accessories.
- Easily interchangeable on site.
- Two tile clips included.
- Specify two tiles per panel opening of corresponding width. Tiles can be combined. For example, Fabric Tile on one side and Accessory Tile on the opposite side of the same panel.
- Accessory Tile cannot be installed opposite an electrical tile.

PRODUCT CODE	PRICE	SIZE/INCHES			WEIGHT VOL	
		H	W	D	LBS	FT <sup>3</sup>
BP3AT0818	97	08	18	0.25	1.7	0.146
BP3AT0824	117	08	24	0.25	2.3	0.167
BP3AT0830	125	08	30	0.25	2.9	0.208
BP3AT0836	151	08	36	0.25	3.5	0.250
BP3AT0842	178	08	42	0.25	4.1	0.292
BP3AT0848	207	08	48	0.25	4.7	0.333
BP3AT0854	226	08	54	0.25	5.3	0.375
BP3AT0860	255	08	60	0.25	5.9	0.417
BP3AT0866	366	08	66	0.25	6.5	0.459
BP3AT0872	476	08	72	0.25	7.0	0.500
BP3AT1618	97	16	18	0.25	3.5	0.292
BP3AT1624	117	16	24	0.25	4.7	0.333
BP3AT1630	125	16	30	0.25	5.7	0.416
BP3AT1636	151	16	36	0.25	7.0	0.500
BP3AT1642	178	16	42	0.25	8.2	0.583
BP3AT1648	207	16	48	0.25	9.4	0.666
BP3AT1654	226	16	54	0.25	10.6	0.750
BP3AT1660	255	16	60	0.25	11.9	0.833
BP3AT1666	366	16	66	0.25	13.0	0.916
BP3AT1672	476	16	72	0.25	14.0	1.000

**BP3FT • Removable Face Tile - Fabric**

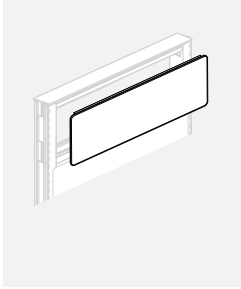

- Attaches to any opening in a Pass-Thru Panel.
- Tile clips included.
- Easily interchangeable on site.
- Specify two tiles per panel opening of corresponding width. Tiles can be combined. For example, Fabric Tile on one side and Accessory Tile on the opposite side of the same panel.
- OPT\* = Laminate or Whiteboard.

PRODUCT CODE	PRICE			SIZE/INCHES			WEIGHT VOL	
	GR1	GR2	OPT*	H	W	D	LBS	FT <sup>3</sup>
BP3FT0818	87	93	101	8	18	0.25	1	0.146
BP3FT0824	93	99	108	8	24	0.25	1	0.165
BP3FT0830	99	113	125	8	30	0.25	2	0.200
BP3FT0836	122	134	150	8	36	0.25	2	0.250
BP3FT0842	130	144	158	8	42	0.25	2	0.292
BP3FT0848	136	150	163	8	48	0.25	3	0.333
BP3FT0854	144	156	169	8	54	0.25	3	0.375
BP3FT0860	150	161	174	8	60	0.25	4	0.417
BP3FT0866	227	281	338	8	66	0.25	4	0.460
BP3FT0872	307	361	-	8	72	0.25	4	0.500
BP3FT1618	87	93	101	16	18	0.25	2	0.292
BP3FT1624	93	99	108	16	24	0.25	2	0.333
BP3FT1630	99	113	125	16	30	0.25	3	0.416
BP3FT1636	122	134	150	16	36	0.25	3	0.500
BP3FT1642	130	144	158	16	42	0.25	3	0.583
BP3FT1648	136	150	163	16	48	0.25	4	0.666
BP3FT1654	144	156	169	16	54	0.25	4	0.750
BP3FT1660	150	161	174	16	60	0.25	5	0.833
BP3FT1666	227	281	338	16	66	0.25	5	0.920
BP3FT1672	307	361	-	16	72	0.25	6	1.000



**BP3OPFA • Fabric Over Panel**

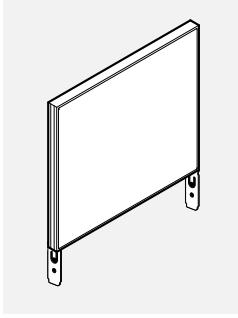

- Attaches to top of a panel to create floor-to-ceiling wall.
- Center septum overlaid on either side with 1 1/8" Sound absorbent mineral board."
- Non-slotted.
- Exact height should be specified when ordering, with allowance of at least 1" of free space between over panel and ceiling to accommodate height variations in ceiling and floor. Can be any height from 4.4" minimum to 15.9" maximum. Please tag exact height required.
- Runs of over panels should be captured at either end with full height posts, wall adapters, taller panels, and/or vertical trims.
- OPT\* = Laminate or Whiteboard.

PRODUCT CODE	PRICE			SIZE/INCHES			WEIGHT VOL	
	GR1	GR2	OPT*	H	W	D	LBS	FT <sup>3</sup>
BP3OPFA18XX	215	227	243	16	18	2.61	8	0.730
BP3OPFA24XX	244	254	269	16	24	2.61	8	0.730
BP3OPFA30XX	280	291	307	16	30	2.61	10	0.912
BP3OPFA36XX	314	328	341	16	36	2.61	12	1.094
BP3OPFA42XX	342	356	371	16	42	2.61	12	1.094
BP3OPFA48XX	379	394	406	16	48	2.61	14	1.277
BP3OPFA54XX	416	426	441	16	54	2.61	14	1.277
BP3OPFA60XX	441	452	469	16	60	2.61	15	1.368

**BP3OPFV • Fabric Over Panel With Vertical Wire Channel**

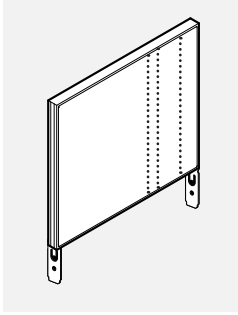

- Attaches to top of a panel to create floor-to-ceiling wall.
- Center septum overlaid on either side with 1" sound absorbent mineral board.
- Non-slotted.
- Exact height should be specified when ordering, with allowance of at least 1" of free space between over panel and ceiling to accommodate height variations in ceiling and floor. Can be any height from 4.4" minimum to 15.9" maximum. Please tag exact height required.
- Runs of over panels should be captured at either end with full height posts, wall adapters, taller panels, and/or vertical trims.
- OPT\* = Laminate or Whiteboard.

PRODUCT CODE	PRICE			SIZE/INCHES			WEIGHT VOL	
	GR1	GR2	OPT*	H	W	D	LBS	FT <sup>3</sup>
BP3OPFV18XX	254	266	280	16	18	2.61	8	0.73
BP3OPFV24XX	281	303	308	16	24	2.61	8	0.73
BP3OPFV30XX	319	330	345	16	30	2.61	10	0.912
BP3OPFV36XX	355	366	382	16	36	2.61	12	1.094
BP3OPFV42XX	382	394	409	16	42	2.61	12	1.094
BP3OPFV48XX	419	431	444	16	48	2.61	14	1.277
BP3OPFV54XX	452	466	479	16	54	2.61	14	1.277
BP3OPFV60XX	480	491	508	16	60	2.61	15	1.368

**BA3PAS • Glass Over Panel With Round Pucks for System 3**

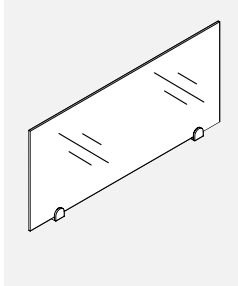

- Glass Over Panel creates division.
- Glass Over Panel with no frame sits on top of a System 3 Panel with clamps that are secured to the top of the panel.
- Tempered glass is 16" high.
- Custom sizes available, contact your Customer Service Representative.
- For application where the over panel is sandwiched between two taller panels, please request a special as the glass will not fit due to trims.

PRODUCT CODE	PRICE		FRST	SIZE/ INCHES			WEIGHT VOL	
	CLR			H	W	D	LBS	FT <sup>3</sup>
BA3PAS0824	212		234	8	24	1.3	4	0.22
BA3PAS0830	231		259	8	30	1.3	5	0.30
BA3PAS0836	249		279	8	36	1.3	6	0.37
BA3PAS0842	263		299	8	42	1.3	7	0.43
BA3PAS0848	271		317	8	48	1.3	8	0.48
BA3PAS1624	212		234	16	24	1.3	8	0.44
BA3PAS1630	231		259	16	30	1.3	10	0.59
BA3PAS1636	249		279	16	36	1.3	12	0.73
BA3PAS1642	263		299	16	42	1.3	14	0.85
BA3PAS1648	271		317	16	48	1.3	16	0.96

**BA3PASS • Glass Over Panel With Square Pucks for System 3**

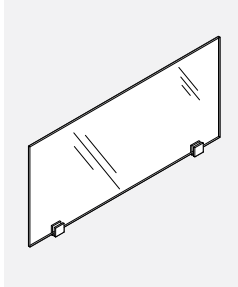

- Glass Over Panel creates division.
- Glass Over Panel with no frame sits on top of a System 3 Panel with clamps that are secured to the top of the panel.
- Tempered glass is 16" high.
- Custom sizes available, contact your Customer Service Representative.
- For application where the over panel is sandwiched between two taller panels, please request a special as the glass will not fit due to trims.

PRODUCT CODE	PRICE		FRST	SIZE/ INCHES			WEIGHT VOL	
	CLR			H	W	D	LBS	FT <sup>3</sup>
BA3PASS0824	216		238	8	24	1.3	4	0.22
BA3PASS0830	237		263	8	30	1.3	5	0.30
BA3PASS0836	253		284	8	36	1.3	6	0.37
BA3PASS0842	268		304	8	42	1.3	7	0.43
BA3PASS0848	277		320	8	48	1.3	8	0.48
BA3PASS1624	216		238	16	24	1.3	8	0.44
BA3PASS1630	237		263	16	30	1.3	10	0.59
BA3PASS1636	253		284	16	36	1.3	12	0.73
BA3PASS1642	268		304	16	42	1.3	14	0.85
BA3PASS1648	277		320	16	48	1.3	16	0.96

**BPMB • Raceway Cover Caps**

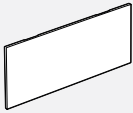

- To provide clean detail for the punch-outs of a raceway cover when the punch-outs are not in use. Order only when required.
- Made of injection molded ABS.
- B = Black
- G = Grey
- W = White

PRODUCT CODE	PRICE	SIZE/INCHES			WEIGHT VOL	
		H	W	D	LBS	FT <sup>3</sup>
BPMB020104B	10	1.5	3	0.125	0.04	0.02
BPMB020104G	10	1.5	3	0.125	0.04	0.02
BPMB020104W	10	1.5	3	0.125	0.04	0.02

**BH3PS • 90 Degree Post**



- Enables connection for multiple panel runs such as 90°, 3 way and 4 way.
- Includes 2 "Capture Strip" panel connectors, 4 end strips, 2 pairs of raceway end caps, and 1 post cap.
- Posts are designed to accept the following:
  - 75 cables 5.6 mm (0.220") diameter
  - 60 cables 5.6 mm (0.220") diameter with 1 power feed
  - 45 cables 5.6 mm (0.220") diameter with 2 power feeds

PRODUCT CODE	PRICE	SIZE/INCHES			WEIGHT VOL	
		H	W	D	LBS	FT <sup>3</sup>
BH3PS034	69	27	2.61	2.61	4	0.14
BH3PS042	104	35	2.61	2.61	5	0.18
BH3PS050	119	43	2.61	2.61	7	0.22
BH3PS054	131	47	2.61	2.61	7	0.27
BH3PS058	137	51	2.61	2.61	8	0.29
BH3PS066	145	59	2.61	2.61	8	0.31

**BH3PS45 • 45 Degree Post**



- Enables connection for two panels at 45°.
- Includes 2 "Capture Strip" panel connectors and 1 post cap.
- 45 degree post does not accept End Trim.
- No power infeed capabilities.
- Posts are designed to accept the following:
  - 30 cables 5.6 mm (0.220") diameter

PRODUCT CODE	PRICE	SIZE/INCHES			WEIGHT VOL	
		H	W	D	LBS	FT <sup>3</sup>
BH3PS45034	69	27	2.61	2.61	4	0.14
BH3PS45042	104	35	2.61	2.61	5	0.18
BH3PS45050	119	43	2.61	2.61	7	0.22
BH3PS45054	131	47	2.61	2.61	7	0.27
BH3PS45058	140	51	2.61	2.61	8	0.29
BH3PS45066	149	59	2.61	2.61	8	0.31

**BH3PS60 • 60 Degree Post**



- Enables connection for multiple panel runs such as 120° and 3 way.
- Includes 2 "Capture Strip" panel connectors and 1 post cap.
- No power infeed capabilities.
- Posts are designed to accept the following:
  - 35 cables 5.6 mm (0.220") diameter

PRODUCT CODE	PRICE	SIZE/INCHES			WEIGHT VOL	
		H	W	D	LBS	FT <sup>3</sup>
BH3PS60034	69	27	2.61	2.61	4	0.14
BH3PS60042	104	35	2.61	2.61	5	0.18
BH3PS60050	119	43	2.61	2.61	7	0.22
BH3PS60054	131	47	2.61	2.61	7	0.27
BH3PS60058	140	51	2.61	2.61	8	0.29
BH3PS60066	149	59	2.61	2.61	8	0.31

**BH3PE • Post Extension for Over Panels**



- Provides route for ceiling data or electrical cables through the post to the panel.
- Includes 2 "Capture Strip" panel connectors.

PRODUCT CODE	PRICE	SIZE/INCHES			WEIGHT VOL	
		H	W	D	LBS	FT <sup>3</sup>
BH3PE008	32	8	2.61	2.61	1	0.03
BH3PE016	39	16	2.61	2.61	2	0.07
BH3PE032	69	32	2.61	2.61	4	0.14
BH3PE45016	39	16	2.61	2.61	2	0.07
BH3PE45032	69	32	2.61	2.61	4	0.14
BH3PE60016	39	16	2.61	2.61	2	0.07
BH3PE60032	70	32	2.61	2.61	4	0.14

**BH3PA • Off-Module Connector (Panel-to-Panel Adapter)**

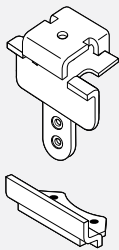

- Connects Boulevard System 3 panel to another perpendicular Boulevard System 3 Monolithic Panel off-module.
- Top and bottom brackets bolt to panel vertical of one panel and engage to top and bottom "fabric" edges of adjacent, perpendicular Monolithic Panel of even height.
- While connecting tile panel to Monolithic Panel is possible, never attempt to secure Off-Module Connectors to a tile panel.
- Once an off-module panel is secure to Monolithic Panel spine with Off-Module Connecting Kit, the raceway on the spine panel cannot be accessed and can only be opened from the opposite side.
- Special top trim required, provide application to your Customer Service Representative.
- This connector is not a load-bearing connection.
- Not to be used on the panel seam, with over panels or laminate and metal faced panels.

PRODUCT CODE	PRICE	SIZE/INCHES			WEIGHT VOL	
		H	W	D	LBS	FT <sup>3</sup>
BH3PA02	77	3.5			0.5	0.035

**RCX3WMP2 • Raceway Cover With Punch-Outs Both Sides**

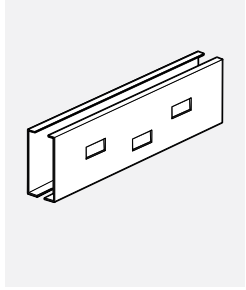

- Metal raceway organizes cables at the base.
- Snaps directly into the base of the panel.
- When opened, cover's side rests on the floor, providing unobstructed access to data/power installation.
- 18" Raceway Covers do not have power and data/communication punch-outs.
- 24" Raceway covers have electrical and one data opening.
- Data opening sizing is as follows: 1.38" x 2.71".
- Comes standard with all System 3 panels.
- "No Knockouts" option for raceways available at no additional charge. Please choose option for interior and/or exterior raceways.

PRODUCT CODE	PRICE	SIZE/INCHES			WEIGHT VOL	
		H	W	D	LBS	FT <sup>3</sup>
RCX3WM24P2	53	5.62	24	2.61	3.3	0.21
RCX3WM30P2	64	5.62	30	2.61	4.1	0.26
RCX3WM36P2	71	5.62	36	2.61	4.9	0.31
RCX3WM42P2	77	5.62	42	2.61	5.7	0.36
RCX3WM48P2	85	5.62	48	2.61	6.6	0.42
RCX3WM54P2	93	5.62	54	2.61	7.4	0.47
RCX3WM60P2	101	5.62	60	2.61	8.3	0.52
RCX3WM66P2	158	5.62	66	2.61	9.1	0.57
RCX3WM72P2	166	5.62	72	2.61	9.8	0.62

**RCX3WMP1 • Raceway Cover With Punch-Outs One Side, None Other Side**

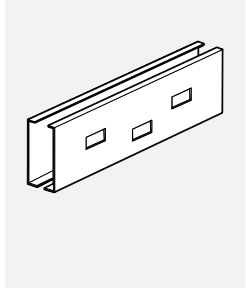

- Metal raceway organizes cables at the base.
- Snaps directly into the base of the panel.
- When opened, cover's side rests on the floor, providing unobstructed access to data/power installation.
- 18" Raceway Covers do not have power and data/communication punch-outs.
- 24" Raceway covers have electrical and one data opening.
- Data opening sizing is as follows: 1.38" x 2.71".
- Comes standard with all System 3 panels.
- "No Knockouts" option for raceways available at no additional charge. Please choose option for interior and/or exterior raceways.

PRODUCT CODE	PRICE	SIZE/INCHES			WEIGHT VOL	
		H	W	D	LBS	FT <sup>3</sup>
RCX3WM24P1	53	5.62	24	2.61	3.3	0.21
RCX3WM30P1	64	5.62	30	2.61	4.1	0.26
RCX3WM36P1	71	5.62	36	2.61	4.9	0.31
RCX3WM42P1	77	5.62	42	2.61	5.7	0.36
RCX3WM48P1	85	5.62	48	2.61	6.6	0.42
RCX3WM54P1	93	5.62	54	2.61	7.4	0.47
RCX3WM60P1	101	5.62	60	2.61	8.3	0.52
RCX3WM66P1	158	5.62	66	2.61	9.1	0.57
RCX3WM72P1	166	5.62	72	2.61	9.8	0.62

**RCX3WMNP • Raceway Cover With No Punch-Outs Both Sides**

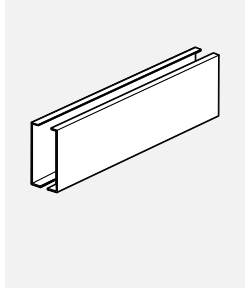

- Metal raceway organizes cables at the base.
- Snaps directly into the base of the panel.
- When opened, cover's side rests on the floor, providing unobstructed access to data/power installation.

PRODUCT CODE	PRICE	SIZE/INCHES			WEIGHT VOL	
		H	W	D	LBS	FT <sup>3</sup>
RCX3WM18NP	45	5.62	18	2.61	2.4	0.16
RCX3WM24NP	53	5.62	24	2.61	3.3	0.21
RCX3WM30NP	64	5.62	30	2.61	4.1	0.26
RCX3WM36NP	71	5.62	36	2.61	4.9	0.31
RCX3WM42NP	77	5.62	42	2.61	5.7	0.36
RCX3WM48NP	85	5.62	48	2.61	6.6	0.42
RCX3WM54NP	93	5.62	54	2.61	7.4	0.47
RCX3WM60NP	101	5.62	60	2.61	8.3	0.52
RCX3WM66NP	158	5.62	66	2.61	9.1	0.57
RCX3WM72NP	166	5.62	72	2.61	9.8	0.62

**RCX3WMP1CH • Chicago Raceway Punch-Out One Side, None Other Side**

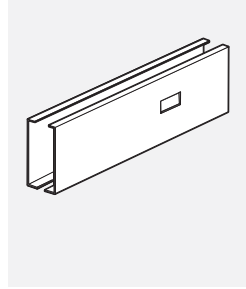

- Metal raceway organizes cables at base.
- To be used with a Chicago Junction Box only
- Snaps directly at the base of the panel.
- When opened, cover's side rests on the floor, providing unobstructed access to data/power installation.

PRODUCT CODE	PRICE	SIZE/ INCHES			WEIGHT VOL	
		H	W	D	LBS	FT <sup>3</sup>
RCX3WM24P1CH	61	5.62	24	2.61	3.3	0.21
RCX3WM30P1CH	70	5.62	30	2.61	4.1	0.26
RCX3WM36P1CH	77	5.62	36	2.61	4.9	0.31
RCX3WM42P1CH	90	5.62	42	2.61	5.7	0.36
RCX3WM48P1CH	97	5.62	48	2.61	6.6	0.42
RCX3WM54P1CH	105	5.62	54	2.61	7.4	0.47
RCX3WM60P1CH	114	5.62	60	2.61	8.3	0.52
RCX3WM66P1CH	120	5.62	66	2.61	9.1	0.57
RCX3WM72P1CH	127	5.62	72	2.61	9.8	0.62

**RCX3WMP2CH • Chicago Raceway Punch-Out Both Side**

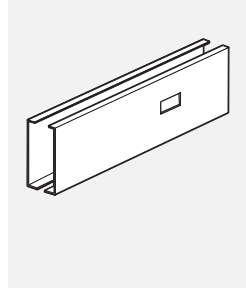

- Metal raceway organizes cables at base.
- To be used with a Chicago Junction Box only
- Snaps directly at the base of the panel.
- When opened, cover's side rests on the floor, providing unobstructed access to data/power installation.

PRODUCT CODE	PRICE	SIZE/ INCHES			WEIGHT VOL	
		H	W	D	LBS	FT <sup>3</sup>
RCX3WM24P2CH	61	5.62	24	2.61	3.3	0.21
RCX3WM30P2CH	70	5.62	30	2.61	4.1	0.26
RCX3WM36P2CH	77	5.62	36	2.61	4.9	0.31
RCX3WM42P2CH	90	5.62	42	2.61	5.7	0.36
RCX3WM48P2CH	97	5.62	48	2.61	6.6	0.42
RCX3WM54P2CH	104	5.62	54	2.61	7.4	0.47
RCX3WM60P2CH	114	5.62	60	2.61	8.3	0.52
RCX3WM66P2CH	120	5.62	66	2.61	9.1	0.57
RCX3WM72P2CH	128	5.62	72	2.61	9.8	0.62

**BG3JB-CH • Chicago Junction Box - Raceway**

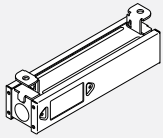

- Provides single power entry from floor raceway.
- Single Ceiling Feed has a 6" whip, liquid tight.
- Raceway connection replaces one Duplex Receptacle Block in a standard kit.

PRODUCT CODE	PRICE	SIZE/INCHES			WEIGHT VOL	
		H	W	D	LBS	FT <sup>3</sup>
BG3JBP1CH	223	2.09	9.78	2.42	1.98	0.03
BG3JBP2CH	230	2.09	9.78	2.42	1.98	0.03

**BH3JB-CH • Chicago Junction Box - Face Mount**

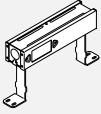

- Provides single power entry from ceiling through a post into raceway.
- Raceway connection replaces one Duplex Receptacle Block in a standard kit.

PRODUCT CODE	PRICE	SIZE/INCHES			WEIGHT VOL	
		H	W	D	LBS	FT <sup>3</sup>
BH3JBP1CH	247	2.09	9.78	2.42	1.98	0.03
BH3JBP2CH	253	2.09	9.78	2.42	1.98	0.03

**B3HWA • Wall Adapter**

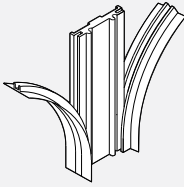

- Starts a run of panels off an existing wall.
- Includes 2 "Capture Strip" panel connectors and 1 pair of raceway end caps.
- Mounting hardware not included.
- Mounting hardware selection should be based on wall or wall stud material.
- Wall Adapter adds 5/16" to a panels run.

PRODUCT CODE	PRICE	SIZE/INCHES			WEIGHT VOL	
		H	W	D	LBS	FT <sup>3</sup>
B3HWA034	48	34	2.61	0.375	2	0.011
B3HWA042	56	42	2.61	0.375	3	0.015
B3HWA050	64	50	2.61	0.375	3	0.018
B3HWA054	72	54	2.61	0.375	3	0.020
B3HWA058	72	58	2.61	0.375	4	0.021
B3HWA066	72	66	2.61	0.375	4	0.021

**BHWASL • Adapter Sleeve**



- Wall Adapter Sleeve is attached to the building to provide flexible support to a panel run.
- As opposed to the BHWA wall adapter, which connects to the panels rigidly to a wall, B1 and B3 Boulevard panels rest inside of the vertical "U" channel, providing up to 3.5" of flexible adjustment.
- For panel runs taller than 66" order two Wall Adapter Sleeves and either have it cut short on the site below ceiling, or cut a rectangular hole in the ceiling tile. Rectangular slots in the Channels correspond to 66", 58", 54", 50" and 42" high B1 and B3 panels.
- Powder coated steel; specify metal finish.
- Note: the Wall Adapter Sleeve provides flexible, non-structural connection, blocks vertical 1" increment clots and cannot, therefore, be used to support overheads and worksurfaces, they must be supported by perpendicular panels, c-legs or gables.
- Note: no fasteners are provided with the Wall Adapter Sleeve. Select the appropriate fasteners according to a structurally sound connection.
- Cannot be used to support a door or panel and cannot be used with laminate, airflow or metal skin panels.

PRODUCT CODE	PRICE	SIZE/INCHES			WEIGHT VOL	
		H	W	D	LBS	FT <sup>3</sup>
BHWASL42	201	34.7	4	2	2.5	0.161
BHWASL50	216	42.7	4	2	3.6	0.148
BHWASL54	223	46.7	4	2	4.2	0.216
BHWASL58	231	52.7	4	2	5.1	0.244
BHWASL66	249	58.7	4	2	6.0	0.272

**BH3CS • Capture Strip Slot Cover**



- An extruded PVC channel to adjoin two panels or a panel to a post. Runs the full length of the panel on both sides providing a positive connection of the "Knuckle-Loc" design.
- Priced per pair.
- Pliable side membranes cover panel slots.
- Included with panel components.
- Only to be ordered separately if required.

PRODUCT CODE	PRICE	SIZE/INCHES			WEIGHT VOL	
		H	W	D	LBS	FT <sup>3</sup>
BH3CS34	15	37			0.24	0.11
BH3CS42	15	42			0.28	0.13
BH3CS50	16	50			0.33	0.15
BH3CS54	16	54			0.31	0.17
BH3CS66	25	66			0.4	0.19

**BH3CE • End Strip Slot Cover**



- End strips with pliable side membrane covers panel slots at end-of-run.
- Priced per pair.
- Included with panel components.
- Only to be ordered separately if required.

PRODUCT CODE	PRICE	SIZE/INCHES			WEIGHT VOL	
		H	W	D	LBS	FT <sup>3</sup>
BH3CE34	12	37			0.12	0.05
BH3CE42	12	42			0.14	0.06
BH3CE50	15	50			0.16	0.07
BH3CE54	15	54			0.31	0.08
BH3CE66	16	66			0.20	0.09

**BA3VTR • Vertical Aluminum End Trim**



- Finishes the vertical edges of panels and posts (90 and 60 degree).
- In the case of the panel, the trim runs from the top of the panel to the bottom of the raceway, enclosing the horizontal channel openings and the raceway opening.
- In the case of the Over Panel, the trim runs from the top of the Over Panel to the bottom of the Over Panel, enclosing the horizontal channel openings.

PRODUCT CODE	PRICE	TYPE	SIZE/INCHES			WEIGHT VOL	
			H	W	D	LBS	FT <sup>3</sup>
BA3VTR34	72	REGULAR PANEL	34	2.61	0.25	1.1	0.03
BA3VTR42	82		42	2.61	0.25	1.4	0.03
BA3VTR50	95		50	2.61	0.25	1.7	0.04
BA3VTR54	112		54	2.61	0.25	1.9	0.04
BA3VTR58	118		58	2.61	0.25	2.1	0.05
BA3VTR66	125		66	2.61	0.25	2.2	0.05
BA3VTE16	38	OVER PANEL	16	2.61	0.25	0.5	0.03
BA3VTE32	72		32	2.61	0.25	1.1	0.06

**BA3VTS • Vertical Aluminum End Trim Standard Step Down**

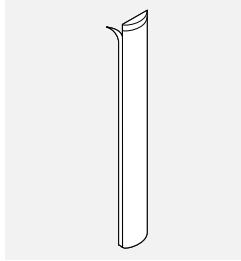

- Finishes the vertical edges of panels and posts (90 and 60 degree).
- Trims run from the top of one panel to the top of lower panel enclosing the horizontal channel opening.

PRODUCT CODE	PRICE	SIZE/INCHES			WEIGHT VOL	
		H	W	D	LBS	FT <sup>3</sup>
BA3VTS04	10	4	2.61	0.25	0.2	0.010
BA3VTS08	26	8	2.61	0.25	0.3	0.015
BA3VTS12	33	12	2.61	0.25	0.4	0.022
BA3VTS16	38	16	2.61	0.25	0.5	0.030
BA3VTS20	45	20	2.61	0.25	0.7	0.039
BA3VTS24	53	24	2.61	0.25	0.9	0.045
BA3VTS32	72	32	2.61	0.25	1.1	0.060

**BV3VTR • Vertical PVC End Trim**

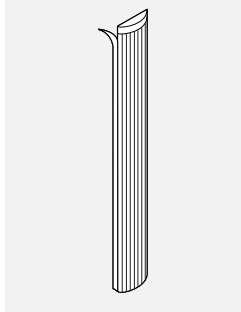

- Finishes the vertical edges of panels and posts (90 and 60 degree).
- In the case of the panel, the trim runs from the top of the panel to the bottom of the raceway, enclosing the horizontal channel openings and the raceway opening.
- In the case of the over panel, the trim runs from the top of the over panel to the bottom of the over panel, enclosing the horizontal channel openings.

PRODUCT CODE	PRICE	TYPE	SIZE/INCHES			WEIGHT VOL	
			H	W	D	LBS	FT <sup>3</sup>
BV3VTR34	48	REGULAR PANEL	34	2.61	0.25	0.6	0.030
BV3VTR42	52		42	2.61	0.25	0.7	0.030
BV3VTR50	64		50	2.61	0.25	0.9	0.040
BV3VTR54	72		54	2.61	0.25	1.0	0.045
BV3VTR58	76		58	2.61	0.25	1.0	0.047
BV3VTR66	81		66	2.61	0.25	1.1	0.050
BV3VTE16	33	OVER PANEL	16	2.61	0.25	0.3	0.030
BV3VTE32	48		32	2.61	0.25	0.6	0.060

**BV3VTS • Vertical PVC End Trim Standard Step Down**

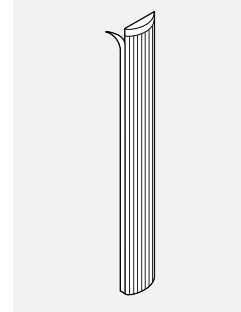

- Finishes the vertical edges of panels and posts (90 and 60 degree).
- Trims run from the top of one panel to the top of lower panel enclosing the horizontal channel opening.

PRODUCT CODE	PRICE	SIZE/INCHES			WEIGHT VOL	
		H	W	D	LBS	FT <sup>3</sup>
BV3VTS04	10	3.75	2.61	0.25	0.1	0.010
BV3VTS08	15	7.75	2.61	0.25	0.1	0.015
BV3VTS12	25	11.75	2.61	0.25	0.2	0.020
BV3VTS16	28	15.75	2.61	0.25	0.3	0.030
BV3VTS20	33	19.75	2.61	0.25	0.3	0.035
BV3VTS24	41	23.75	2.61	0.25	0.4	0.045
BV3VTS32	48	31.75	2.61	0.25	0.6	0.060

**BA3VTRF • Vertical Aluminum Flat End Trim**

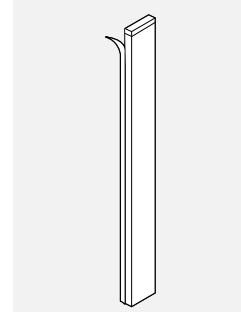

- Finishes the vertical edges of panels and posts (90 and 60 degree).
- In the case of the panel, the trim runs from the top of the panel to the bottom of the raceway, enclosing the horizontal channel openings and the raceway opening.
- In the case of the over panel, the trim runs from the top of the over panel to the bottom of the over panel, enclosing the horizontal channel openings.
- BABVTRF119 cannot ship via courier and must be combined with other product.

PRODUCT CODE	PRICE	TYPE	SIZE/INCHES			WEIGHT VOL	
			H	W	D	LBS	FT <sup>3</sup>
BA3VTRF34	72	REGULAR PANEL	34	2.61	0.125	1.1	0.03
BA3VTRF42	82		42	2.61	0.125	1.4	0.03
BA3VTRF50	95		50	2.61	0.125	1.7	0.04
BA3VTRF54	112		54	2.61	0.125	1.9	0.04
BA3VTRF58	118		58	2.61	0.125	1.9	0.04
BA3VTRF66	125		66	2.61	0.125	2.2	0.05
BA3VTRF119	190		119	2.61	0.125	3.6	0.08
BA3VTEF8	17	OVER PANEL	8	2.61	0.125	0.2	0.01
BA3VTEF16	38		16	2.61	0.125	0.5	0.03
BA3VTEF32	72		32	2.61	0.125	1.1	0.06

**BA3VTSF • Vertical Aluminum Flat End Trim Standard Step Down**

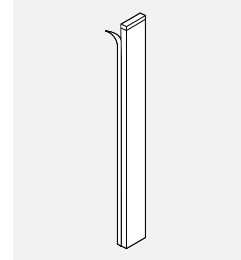

- Finishes the vertical edges of panels and posts (90 and 60 degree).
- Trims run from the top of one panel to the top of lower panel enclosing the horizontal channel opening.

PRODUCT CODE	PRICE	SIZE/INCHES			WEIGHT VOL	
		H	W	D	LBS	FT <sup>3</sup>
BA3VTSF04	13	3.75	2.61	0.125	0.1	0.010
BA3VTSF08	26	7.75	2.61	0.125	0.3	0.015
BA3VTSF12	33	11.75	2.61	0.125	0.4	0.020
BA3VTSF16	38	15.75	2.61	0.125	0.5	0.030
BA3VTSF20	45	19.75	2.61	0.125	0.8	0.035
BA3VTSF24	53	23.75	2.61	0.125	0.9	0.045
BA3VTSF32	72	31.75	2.61	0.125	1.1	0.060

**B3LEP-NC • End-of-Run Gallery Panel in a T configuration, No Connectors for Additional Gallery Panels**

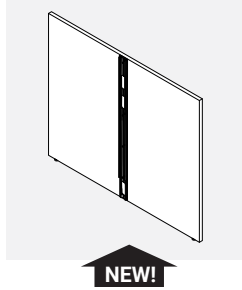

- Provides floor standing support while enclosing the end of a panel run on two sides.
- Attaches to the end of a Boulevard Panel with capture strips to form a T configuration.
- Connection is on the interior face center.
- Includes all attachment hardware and glides.
- Total height is inclusive of panel glides extended to their full height.
- 51" wide gallery panel accommodates two 24" deep surfaces while the 63" wide accommodates two 30" deep surfaces and 75" wide two 36" deep surfaces.
- Please specify LP laminate finish and PVC edge finish.
- If a wood grain laminate is chosen, grain direction run horizontally.
- Edged in PVC on three exposed edges and self edged on bottom.

PRODUCT CODE	PRICE LP	SIZE/INCHES			WEIGHT LBS	VOL FT <sup>3</sup>
		H	W	D		
B3LEP4227NC	606	42	26.5	1	29.49	0.64
B3LEP4251NC	951	42	51	1	55.17	1.24
B3LEP4263NC	1065	42	63	1	68.01	1.53
B3LEP4275NC	1185	42	75	1	80.86	1.82
B3LEP5027NC	707	50	26.5	1	35.25	0.77
B3LEP5051NC	1104	50	51	1	65.92	1.48
B3LEP5063NC	1244	50	63	1	81.27	1.82
B3LEP5075NC	1404	50	75	1	96.62	2.17
B3LEP5427NC	707	54	26.5	1	38.12	0.83
B3LEP5451NC	1137	54	51	1	71.3	1.59
B3LEP5463NC	1281	54	63	1	87.9	1.97
B3LEP5475NC	1448	54	75	1	104.49	2.34

**B3LSEPL-NC • Left End-of-Run Single Gallery Panel in L Configuration, No Connectors for Additional Gallery Panels**

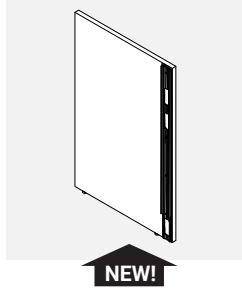

- Provides floor standing support while enclosing the end of a panel run on one side.
- Attaches to the end of a Boulevard Panel with capture strips to form an L configuration.
- Connection is on interior face near it's right end.
- Includes all attachment hardware and glides.
- Total height is inclusive of panel glides extended to their full height.
- 27" wide gallery panel accommodates a 24" deep surface while the 33" wide accommodates a 30" deep surface and 39" wide a 36" deep surface.
- Please specify LP laminate finish and PVC edge finish.
- If a wood grain laminate is chosen, grain direction run horizontally.
- Edged in PVC on three exposed edges and self edged on bottom.

PRODUCT CODE	PRICE LP	SIZE/INCHES			WEIGHT LBS	VOL FT <sup>3</sup>
		H	W	D		
B3LSEPL4215NC	498	42	14.25	1	16.64	0.35
B3LSEPL4227NC	725	42	27	1	29.47	0.66
B3LSEPL4233NC	782	42	33	1	35.89	0.80
B3LSEPL4239NC	822	42	39	1	42.32	0.95
B3LSEPL5015NC	567	50	14.25	1	19.9	0.41
B3LSEPL5027NC	824	50	27	1	35.23	0.78
B3LSEPL5033NC	893	50	33	1	42.9	0.95
B3LSEPL5039NC	956	50	39	1	50.57	1.13
B3LSEPL5415NC	567	54	14.25	1	21.52	0.45
B3LSEPL5427NC	848	54	27	1	38.1	0.84
B3LSEPL5433NC	921	54	33	1	46.4	1.03
B3LSEPL5439NC	986	54	39	1	54.7	1.22

**B3LSEPR-NC • Right End-of-Run Single Gallery Panel in L Configuration, No Connectors for Additional Gallery Panels**

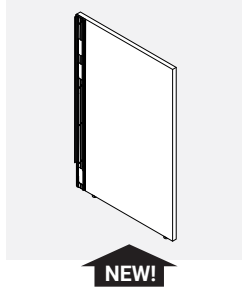

- Provides floor standing support while enclosing the end of a panel run on one side.
- Attaches to the end of a Boulevard Panel with capture strips to form an L configuration.
- Connection is on interior face near it's right end.
- - Includes all attachment hardware and glides.
- Total height is inclusive of panel glides extended to their full height.
- 27" wide gallery panel accommodates a 24" deep surface while the 33" wide accommodates a 30" deep surface and 39" wide a 36" deep surface.
- Please specify LP laminate finish and PVC edge finish.
- If a wood grain laminate is chosen, grain direction run horizontally.
- Edged in PVC on three exposed edges and self edged on bottom.

PRODUCT CODE	PRICE LP	SIZE/INCHES			WEIGHT LBS	VOL FT <sup>3</sup>
		H	W	D		
B3LSEPR4215NC	498	42	14.25	1	16.64	0.35
B3LSEPR4227NC	725	42	27	1	29.47	0.66
B3LSEPR4233NC	782	42	33	1	35.89	0.80
B3LSEPR4239NC	822	42	39	1	42.32	0.95
B3LSEPR5015NC	567	50	14.25	1	19.9	0.41
B3LSEPR5027NC	824	50	27	1	35.23	0.78
B3LSEPR5033NC	893	50	33	1	42.9	0.95
B3LSEPR5039NC	956	50	39	1	50.57	1.13
B3LSEPR5415NC	567	54	14.25	1	21.52	0.45
B3LSEPR5427NC	848	54	27	1	38.1	0.84
B3LSEPR5433NC	921	54	33	1	46.4	1.03
B3LSEPR5439NC	986	54	39	1	54.7	1.22

**B3LMP-NC • Middle-of-Run Single Gallery Panel in X Configuration, No Connectors for Additional Gallery Panels**

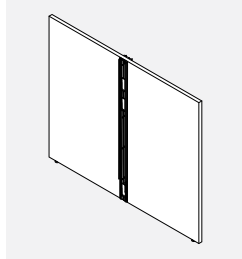

- Provides floor standing support in the middle of a panel run.
- Attaches between panels in a straight Boulevard Panel run with capture strips to form an X configuration.
- Connections are at the center of the interior and exterior faces.
- Includes all attachment hardware and glides.
- Total height is inclusive of panel glides extended to their full height.
- 51" wide gallery panel accommodates two 24" deep surfaces while the 63" wide accommodates two 30" deep surfaces and 75" wide two 36" deep surfaces.
- Please specify LP laminate finish and PVC edge finish.
- If a wood grain laminate is chosen, grain direction run horizontally.
- Edged in PVC on three exposed edges and self edged on bottom.

PRODUCT CODE	PRICE LP	SIZE/INCHES			WEIGHT LBS	VOL FT <sup>3</sup>
		H	W	D		
B3LMP4251NC	1260	42	51	1	55.98	1.24
B3LMP4263NC	1373	42	63	1	68.83	1.53
B3LMP4275NC	1497	42	75	1	81.68	1.85
B3LMP5051NC	1428	50	51	1	66.97	1.48
B3LMP5063NC	1569	50	63	1	82.32	1.82
B3LMP5075NC	1730	50	75	1	97.67	2.17
B3LMP5451NC	1470	54	51	1	72.46	1.59
B3LMP5463NC	1616	54	63	1	89.06	1.97
B3LMP5475NC	1781	54	75	1	105.66	2.34

**B3LSMP-NC • Middle-of-Run Single Gallery Panel in T Configuration, No Connectors for Additional Gallery Panels**

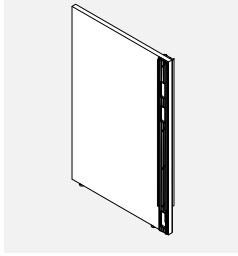

- Provides floor standing support at the middle of a panel run.
- Attaches in the middle of a straight Boulevard Panel run with capture strips to form a T configuration.
- Connections are on the interior and exterior faces of one end.
- Includes all attachment hardware and glides.
- Total height is inclusive of panel glides extended to their full height.
- 27" wide gallery panel accommodates a 24" deep surface while the 33" wide accommodates a 30" deep surface and 39" wide a 36" deep surface.
- Please specify LP laminate finish and PVC edge finish.
- If a wood grain laminate is chosen, grain direction run horizontally.
- Edged in PVC on three exposed edges and self edged on bottom.

PRODUCT CODE	PRICE LP	SIZE /INCHES			WEIGHT LBS	VOL FT <sup>3</sup>
		H	W	D		
B3LSMP4227NC	1037	42	27	1	30.28	0.66
B3LSMP4233NC	1091	42	33	1	36.71	0.80
B3LSMP4239NC	1133	42	39	1	43.13	0.95
B3LSMP5027NC	1148	50	27	1	36.28	0.78
B3LSMP5033NC	1217	50	33	1	43.95	0.95
B3LSMP5039NC	1280	50	39	1	51.63	1.13
B3LSMP5427NC	1182	54	27	1	39.26	0.84
B3LSMP5433NC	1254	54	33	1	47.56	1.03
B3LSMP5439NC	1319	54	39	1	55.86	1.22

**B3LEP • End-of-Run Gallery Panel in a T configuration, With Connectors for Additional Gallery Panels**

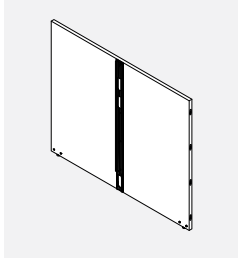

- Provides floor standing support while enclosing the end of a panel run.
- Attaches to the end of a Boulevard panel with capture strips to form a T configuration.
- Connections at both ends as well as on the middle of interior face.
- The end connections are to connect other Gallery Panels.
- The side right is compatible with right hand Gallery Panels (B3LXPRxxxx and B3LXPRxxxxNC, B3L2PRxxxx and B3L3PRxxxx) only.
- The left side is compatible with left hand Gallery Panels (B3LXPLxxxx and B3LXPLxxxxNC, B3L2PLxxxx and B3L3PLxxxx) only.
- The middle interior face connections are for Boulevard panels.
- Includes all attachment hardware and glides.
- Total height is inclusive of panel glides extended to their full height.
- 51" wide gallery panel accommodates two 24" deep surface while the 63" wide accommodates two 30" deep surfaces and 75" wide two 36" deep surfaces.
- Please specify LP laminate finish and PVC edge finish.
- If a wood grain laminate is chosen, grain direction run horizontally.
- Gallery panel is edged in PVC on exposed top edge only and self edged on the three other edges.

PRODUCT CODE	PRICE LP	SIZE /INCHES			WEIGHT LBS	VOL FT <sup>3</sup>
		H	W	D		
B3LEP4251	972	42	51	1	55.25	1.24
B3LEP4263	1085	42	63	1	68.1	1.53
B3LEP4275	1206	42	75	1	80.95	1.82
B3LEP5051	1125	50	51	1	66.01	1.48
B3LEP5063	1265	50	63	1	81.36	1.82
B3LEP5075	1425	50	75	1	96.71	2.17
B3LEP5451	1158	54	51	1	71.38	1.59
B3LEP5463	1302	54	63	1	87.98	1.97
B3LEP5475	1469	54	75	1	104.58	2.34

**B3LSEPL • Left End-of-Run Single Gallery Panel in L Configuration, With Connectors for Additional Gallery Panels**

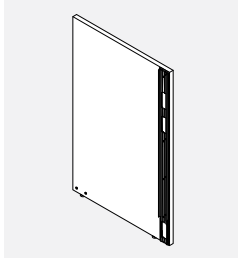

- Provides floor standing support while enclosing the end of a panel run.
- Attaches at the end of a Boulevard panel with capture strips to form an L configuration.
- Connection to the Boulevard panel is on interior face near it's right end.
- Connections for a Gallery Panel are on the left edge.
- Compatible with left hand Gallery Panels (B3LXPLxxxx and B3LXPLxxxxNC, B3L2PLxxxx and B3L3PLxxxx) only.
- Includes all attachment hardware and glides.
- Total height is inclusive of panel glides extended to their full height.
- 27" wide gallery panel accommodates a 24" deep surface while the 33" wide accommodates a 30" deep surface and 39" wide a 36" deep surface.
- Please specify LP laminate finish and PVC edge finish.
- If a wood grain laminate is chosen, grain direction run horizontally.
- Edged in PVC on two exposed edges, self edged on connecting to gallery panel edge and the bottom.

PRODUCT CODE	PRICE LP	SIZE /INCHES			WEIGHT LBS	VOL FT <sup>3</sup>
		H	W	D		
B3LSEPL4227	735	42	27	1	29.51	0.66
B3LSEPL4233	792	42	33	1	35.94	0.80
B3LSEPL4239	831	42	39	1	42.36	0.95
B3LSEPL5027	834	50	27	1	35.27	0.78
B3LSEPL5033	905	50	33	1	42.94	0.95
B3LSEPL5039	968	50	39	1	50.62	1.13
B3LSEPL5427	858	54	27	1	38.14	0.84
B3LSEPL5433	930	54	33	1	46.44	1.03
B3LSEPL5439	995	54	39	1	54.74	1.22

**B3LSEPR • Right End-of-Run Single Gallery Panel in L Configuration, With Connectors for Additional Gallery Panels**

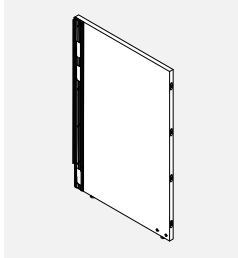

- Provides floor standing support while enclosing the end of a panel run.
- Attaches at the end of a Boulevard panel with capture strips to form an L configuration.
- Connection to the Boulevard panel is on interior face near it's left end.
- Connections for a Gallery Panel are on the right edge.
- Compatible with right hand Gallery Panels (B3LXPRxxxx and B3LXPRxxxxNC, B3L2PRxxxx and B3L3PRxxxx) only.
- Includes all attachment hardware and glides.
- Total height is inclusive of panel glides extended to their full height.
- 27" wide gallery panel accommodates a 24" deep surface while the 33" wide accommodates a 30" deep surface and 39" wide a 36" deep surface.
- Please specify LP laminate finish and PVC edge finish.
- If a wood grain laminate is chosen, grain direction run horizontally.
- Edged in PVC on two exposed edges, self edged on connecting to gallery panel edge and the bottom.

PRODUCT CODE	PRICE LP	SIZE /INCHES			WEIGHT LBS	VOL FT <sup>3</sup>
		H	W	D		
B3LSEPR4227	735	42	27	1	29.51	0.66
B3LSEPR4233	792	42	33	1	35.94	0.80
B3LSEPR4239	831	42	39	1	42.36	0.95
B3LSEPR5027	834	50	27	1	35.27	0.78
B3LSEPR5033	905	50	33	1	42.94	0.95
B3LSEPR5039	968	50	39	1	50.62	1.13
B3LSEPR5427	858	54	27	1	38.14	0.84
B3LSEPR5433	930	54	33	1	46.44	1.03
B3LSEPR5439	995	54	39	1	54.74	1.22

**B3LMP • Middle-of-Run Single Gallery Panel in X Configuration, With Connectors for Additional Gallery Panels**

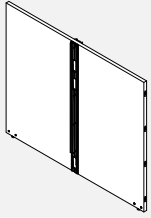

- Provides floor standing support in the middle of a panel run.
- Attached in the middle of a straight Boulevard Panel run with capture strips to form an X configuration.
- Connections at both ends (for Gallery Panels) as well as on the middle of the interior and exterior faces (for Boulevard Panels).
- The right side is compatible with right hand Gallery Panels (B3LXPRxxxx and B3LXPRxxxxNC, B3L2PRxxxx and B3L3PRxxxx) only.
- The left side is compatible with left hand Gallery Panels (B3LXPLxxxx and B3LXPLxxxxNC, B3L2PLxxxx and B3L3PLxxxx) only.
- Includes all attachment hardware and glides.
- Total height is inclusive of panel glides extended to their full height.
- 51" wide gallery panel accommodates two 24" deep surface while the 63" wide accommodates two 30" deep surfaces and 75" wide two 36" deep surfaces.
- Please specify LP laminate finish and PVC edge finish.
- If a wood grain laminate is chosen, grain direction run horizontally.
- Edged in PVC on exposed top edge only and self edged on the three other.

PRODUCT CODE	PRICE	SIZE/INCHES			WEIGHT	VOL
	LP	H	W	D	LBS	FT <sup>3</sup>
B3LMP4251	1281	42	51	1	56.07	1.24
B3LMP4263	1395	42	63	1	68.91	1.53
B3LMP4275	1517	42	75	1	81.76	1.82
B3LMP5051	1449	50	51	1	67.06	1.48
B3LMP5063	1587	50	63	1	82.41	1.82
B3LMP5075	1749	50	75	1	97.76	2.17
B3LMP5451	1491	54	51	1	72.55	1.59
B3LMP5463	1635	54	63	1	89.15	1.97
B3LMP5475	1802	54	75	1	105.74	2.34

**B3LSMP • Middle-of-Run Single Gallery Panel in T Configuration, With Connectors for Additional Gallery Panels**

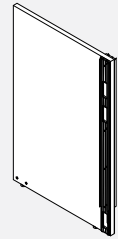

- Provides floor standing support at the middle of a panel run.
- Attached in the middle of a straight Boulevard Panel run with capture strips to form a T configuration.
- Connections are on the exposed edge (for Gallery Panel) and near the opposite end on both interior and exterior faces (for Boulevard Panels).
- Compatible with left hand gallery panels (B3LXPLxxxx and B3LXPLxxxxNC, B3L2PLxxxx and B3L3PLxxxx) only.
- Includes all attachment hardware and glides.
- Total height is inclusive of panel glides extended to their full height.
- 27" wide gallery panel accommodates a 24" deep surface while the 33" wide accommodates a 30" deep surface and 39" wide a 36" deep surface.
- Please specify LP laminate finish and PVC edge finish.
- If a wood grain laminate is chosen, grain direction run horizontally.
- Edged in PVC on two exposed edges, self edged on connecting to gallery panel edge and the bottom.

PRODUCT CODE	PRICE	SIZE/INCHES			WEIGHT	VOL
	LP	H	W	D	LBS	FT <sup>3</sup>
B3LSMP4227	1044	42	27	1	30.33	0.66
B3LSMP4233	1103	42	33	1	36.75	0.80
B3LSMP4239	1142	42	39	1	43.17	0.95
B3LSMP5027	1158	50	27	1	36.32	0.78
B3LSMP5033	1227	50	33	1	43.99	0.95
B3LSMP5039	1290	50	39	1	51.67	1.13
B3LSMP5427	1193	54	27	1	39.31	0.84
B3LSMP5433	1265	54	33	1	47.61	1.03
B3LSMP5439	1329	54	39	1	55.91	1.22

**B3LXPL • Left Gallery Panel Extension, With Connectors for Additional Gallery Panels**

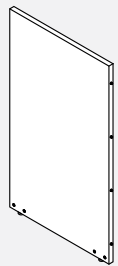

**NEW!**

- Provides floor standing support while extending the Gallery Panels run.
- Attaches to the left edge of a Gallery Panel by the pin connectors to allow for additional Gallery Panels to be added on the left side.
- Pin connectors on the right edge and modular connectors on the left edge of the interior face.
- The right side is compatible with Gallery Panels (B3LEPxxx, B3LSEPL, B3LMPxxx, B3LSMP and B3LXPLxxx) only.
- The left side is compatible with left hand Gallery Panels (B3LXPLxxxx and B3LXPLxxxxNC, B3L2PLxxxx and B3L3PLxxxx) only.
- Includes all attachment hardware and glides.
- Total height is inclusive of panel glides extended to their full height.
- Please specify LP laminate finish and PVC edge finish.
- If a wood grain laminate is chosen, grain direction run horizontally.
- Edged in PVC on exposed top edge only and self edges on the three other.
- Edged in PVC on two exposed edges, self edged on connecting to gallery panel edge and the bottom.

PRODUCT CODE	PRICE	SIZE/INCHES			WEIGHT	VOL
	LP	H	W	D	LBS	FT <sup>3</sup>
B3LXPL4224	378	42	24	1	25.83	0.58
B3LXPL4230	435	42	30	1	32.26	0.73
B3LXPL4236	492	42	36	1	38.68	0.88
B3LXPL4242	548	42	42	1	45.11	1.02
B3LXPL4248	605	42	48	1	51.53	1.17
B3LXPL5024	450	50	24	1	30.83	0.69
B3LXPL5030	521	50	30	1	38.51	0.87
B3LXPL5036	591	50	36	1	46.18	1.04
B3LXPL5042	660	50	42	1	53.86	1.22
B3LXPL5048	731	50	48	1	61.53	1.39
B3LXPL5424	465	54	24	1	33.34	0.75
B3LXPL5430	537	54	30	1	41.64	0.94
B3LXPL5436	608	54	36	1	49.94	1.13
B3LXPL5442	678	54	42	1	58.24	1.31
B3LXPL5448	755	54	48	1	66.54	1.50



**B3LXPR • Right Gallery Panel Extension, With Connectors for Additional Gallery Panels**

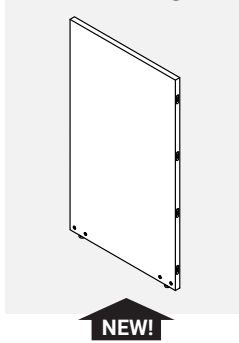

- Provides floor standing support while extending the Gallery Panels run.
- Attaches to the right edge of a Gallery Panel by the pin connectors to allow for additional Gallery Panels to be added on the right side.
- Pin connectors on the right edge and modular connectors on the left edge of the interior face.
- The right side is compatible with right hand Gallery Panels (B3LXPRxxxx and B3LXPRxxxxNC, B3L2PRxxxx and B3L3PRxxxx) only.
- The left side is compatible with Gallery Panels (B3LEPxxx, B3LSEPRxxx, B3LMPxxx and B3LXPRxxx ) only.
- Includes all attachment hardware and glides.
- Total height is inclusive of panel glides extended to their full height.
- Please specify LP laminate finish and PVC edge finish.
- If a wood grain laminate is chosen, grain direction run horizontally.
- Edged in PVC on exposed top edge only and self edges on the three other.

PRODUCT CODE	PRICE LP	SIZE /INCHES			WEIGHT LBS	VOL FT <sup>3</sup>
		H	W	D		
B3LXPR4224	378	42	24	1	25.83	0.58
B3LXPR4230	435	42	30	1	32.26	0.73
B3LXPR4236	492	42	36	1	38.68	0.88
B3LXPR4242	548	42	42	1	45.11	1.02
B3LXPR4248	605	42	48	1	51.53	1.17
B3LXPR5024	450	50	24	1	30.83	0.69
B3LXPR5030	521	50	30	1	38.51	0.87
B3LXPR5036	591	50	36	1	46.18	1.04
B3LXPR5042	660	50	42	1	53.86	1.22
B3LXPR5048	731	50	48	1	61.53	1.39
B3LXPR5424	465	54	24	1	33.34	0.75
B3LXPR5430	537	54	30	1	41.64	0.94
B3LXPR5436	608	54	36	1	49.94	1.13
B3LXPR5442	678	54	42	1	58.24	1.31
B3LXPR5448	755	54	48	1	66.54	1.50

**B3LXPL-NC • Left Gallery Panel Extension, No Connectors for Additional Gallery Panels**

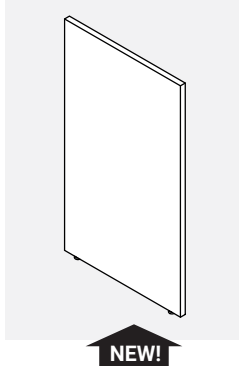

- Provides floor standing support while enclosing the end of a Gallery Panel left run.
- Attached to the left edge of a Gallery Panel by the pin connectors to finish the run.
- Pin connectors are on the right edge of the interior face.
- Compatible with gallery panels (B3LEPxxxx, B3LSEPLxxxx, B3LMPxxxx, B3LSMPxxxx and B3LXPLxxxx) only.
- Includes all attachment hardware and glides.
- Total height is inclusive of panel glides extended to their full height.
- Please specify LP laminate finish and PVC edge finish.
- If a wood grain laminate is chosen, grain direction run horizontally.
- Edged in PVC on two exposed edges, self edged on connecting to gallery panel edge and the bottom.

PRODUCT CODE	PRICE LP	SIZE /INCHES			WEIGHT LBS	VOL FT <sup>3</sup>
		H	W	D		
B3LXPL4212NC	207	42	12	1	12.95	0.29
B3LXPL4224NC	368	42	24	1	25.8	0.58
B3LXPL4230NC	425	42	30	1	32.22	0.73
B3LXPL4236NC	480	42	36	1	38.65	0.88
B3LXPL4242NC	539	42	42	1	45.07	1.02
B3LXPL4248NC	594	42	48	1	51.5	1.17
B3LXPL5012NC	258	50	12	1	15.45	0.35
B3LXPL5024NC	441	50	24	1	30.8	0.69
B3LXPL5030NC	510	50	30	1	38.47	0.87
B3LXPL5036NC	579	50	36	1	46.15	1.04
B3LXPL5042NC	653	50	42	1	53.82	1.22
B3LXPL5048NC	722	50	48	1	61.5	1.39
B3LXPL5412NC	258	54	12	1	16.7	0.38
B3LXPL5424NC	455	54	24	1	33.3	0.75
B3LXPL5430NC	527	54	30	1	41.6	0.94
B3LXPL5436NC	597	54	36	1	49.9	1.13
B3LXPL5442NC	671	54	42	1	58.2	1.31
B3LXPL5448NC	741	54	48	1	66.5	1.50

**B3LXPR-NC • Right Gallery Panel Extension, No Connectors for Additional Gallery Panels**

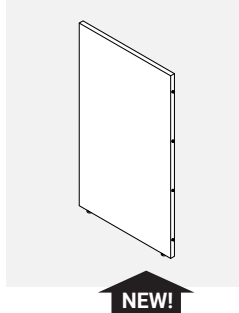

- Provides floor standing support while enclosing the end of a Gallery Panel right run.
- Attached to the right edge of a Gallery Panel by the pin connectors to finish the run.
- Pin connectors are on the left edge of the interior face.
- Compatible with gallery panels (B3LEPxxxx, B3LSEPRxxxx, B3LMPxxxx and B3LXPRxxxx) only.
- Includes all attachment hardware and glides.
- Total height is inclusive of panel glides extended to their full height.
- Please specify LP laminate finish and PVC edge finish.
- If a wood grain laminate is chosen, grain direction run horizontally.
- Edged in PVC on two exposed edges, self edged on connecting to gallery panel edge and the bottom.

PRODUCT CODE	PRICE LP	SIZE /INCHES			WEIGHT LBS	VOL FT <sup>3</sup>
		H	W	D		
B3LXPR4212NC	207	42	12	1	12.95	0.29
B3LXPR4224NC	368	42	24	1	25.8	0.58
B3LXPR4230NC	425	42	30	1	32.22	0.73
B3LXPR4236NC	480	42	36	1	38.65	0.88
B3LXPR4242NC	539	42	42	1	45.07	1.02
B3LXPR4248NC	594	42	48	1	51.5	1.17
B3LXPR5012NC	258	50	12	1	15.45	0.35
B3LXPR5024NC	441	50	24	1	30.8	0.69
B3LXPR5030NC	510	50	30	1	38.47	0.87
B3LXPR5036NC	579	50	36	1	46.15	1.04
B3LXPR5042NC	653	50	42	1	53.82	1.22
B3LXPR5048NC	722	50	48	1	61.5	1.39
B3LXPR5412NC	258	54	12	1	16.7	0.38
B3LXPR5424NC	455	54	24	1	33.3	0.75
B3LXPR5430NC	527	54	30	1	41.6	0.94
B3LXPR5436NC	597	54	36	1	49.9	1.13
B3LXPR5442NC	671	54	42	1	58.2	1.31
B3LXPR5448NC	741	54	48	1	66.5	1.50

**B3L2PR • Right Gallery Panel End-of-Run Return**

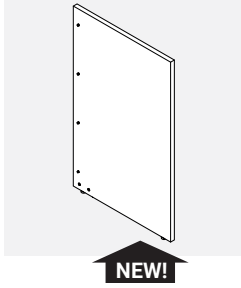

- Provides floor standing support while enclosing the end of a gallery panel run.
- Attaches at the Gallery Panel right edge with connectors to form an L configuration.
- Connections to Gallery Panel are on the interior face near it's left end.
- Compatible with Gallery Panels (B3LEPxxxx, B3LSEPRxxxx, B3LMPxxxx and B3LXPRxxxx) only.
- Includes all attachment hardware and glides.
- Total height is inclusive of panel glides extended to their full height.
- 25" wide gallery panel accommodates a 24" deep surface while the 31" wide accommodates a 30" deep surface and 37" wide a 36" deep surface.
- Please specify LP laminate finish and PVC edge finish.
- If a wood grain laminate is chosen, grain direction run horizontally.
- Edged in PVC on three exposed edges and self edged on the bottom edge.

PRODUCT CODE	PRICE LP	SIZE /INCHES			WEIGHT LBS	VOL FT <sup>3</sup>
		H	W	D		
B3L2PR4213	224	42	13	1	14.02	0.32
B3L2PR4225	425	42	25	1	26.87	0.61
B3L2PR4231	480	42	31	1	33.29	0.75
B3L2PR4237	521	42	37	1	39.72	0.90
B3L2PR5013	279	50	13	1	16.73	0.38
B3L2PR5025	510	50	25	1	32.08	0.72
B3L2PR5031	579	50	31	1	39.75	0.90
B3L2PR5037	642	50	37	1	47.43	1.07
B3L2PR5413	279	54	13	1	18.08	0.41
B3L2PR5425	527	54	25	1	34.68	0.78
B3L2PR5431	597	54	31	1	42.98	0.97
B3L2PR5437	662	54	37	1	51.28	1.16

**B3L2PL • Left Gallery Panel End-of-Run Return**

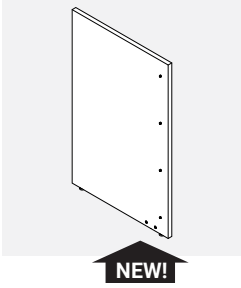

- Provides floor standing support while enclosing the end of a gallery panel run.
- Attaches at the Gallery Panel left edge with connectors to form an L configuration.
- Connections to Gallery Panel are on the interior face near it's right end.
- Compatible with Gallery Panels (B3LEPxxxx, B3LSEPLxxxx, B3LMPxxxx, B3LSMPxxxx and B3LXPLxxxx) only.
- Includes all attachment hardware and glides.
- Total height is inclusive of panel glides extended to their full height.
- 25" wide gallery panel accommodates a 24" deep surface while the 31" wide accommodates a 30" deep surface and 37" wide a 36" deep surface.
- Please specify LP laminate finish and PVC edge finish.
- If a wood grain laminate is chosen, grain direction run horizontally.
- Edged in PVC on three exposed edges and self edged on the bottom edge.

PRODUCT CODE	PRICE LP	SIZE /INCHES			WEIGHT LBS	VOL FT <sup>3</sup>
		H	W	D		
B3L2PL4213	224	42	13	1	14.02	0.32
B3L2PL4225	425	42	25	1	26.87	0.61
B3L2PL4231	480	42	31	1	33.29	0.75
B3L2PL4237	521	42	37	1	39.72	0.90
B3L2PL5013	279	50	13	1	16.73	0.38
B3L2PL5025	510	50	25	1	32.08	0.72
B3L2PL5031	579	50	31	1	39.75	0.90
B3L2PL5037	642	50	37	1	47.43	1.07
B3L2PL5413	279	54	13	1	18.08	0.41
B3L2PL5425	527	54	25	1	34.68	0.78
B3L2PL5431	597	54	31	1	42.98	0.97
B3L2PL5437	662	54	37	1	51.28	1.16

**B3L3PL • Left Gallery Panel End-of-Run 3-Way Return**

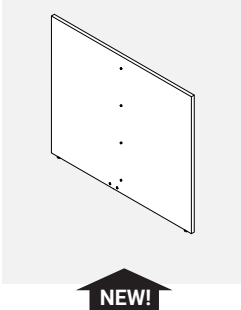

- Provides floor standing support while enclosing the end of a gallery panel run.
- Attaches to the Gallery Panel left edge with connectors to form an T configuration.
- Connections to Gallery Panel are on the interior face in the middle.
- Compatible with Gallery Panels (B3LEPxxxx, B3LSEPLxxxx, B3LMPxxxx, B3LSMPxxxx and B3LXPLxxxx) only.
- Includes all attachment hardware and glides.
- Total height is inclusive of panel glides extended to their full height.
- 49" wide gallery panel accommodates two 24" deep surfaces while the 61" wide accommodates two 30" deep surface and 73" wide two 36" deep surface.
- Please specify LP laminate finish and PVC edge finish.
- If a wood grain laminate is chosen, grain direction run horizontally.
- Edged in PVC on three exposed edges and self edged on the bottom edge.

PRODUCT CODE	PRICE LP	SIZE /INCHES			WEIGHT LBS	VOL FT <sup>3</sup>
		H	W	D		
B3L3PL4225	333	42	25	1	26.87	0.61
B3L3PL4249	576	42	49	1	52.57	1.19
B3L3PL4261	764	42	61	1	65.41	1.48
B3L3PL4273	887	42	73	1	78.26	1.77
B3L3PL5025	417	50	25	1	32.08	0.72
B3L3PL5049	791	50	49	1	62.77	1.42
B3L3PL5061	930	50	61	1	78.12	1.77
B3L3PL5073	1091	50	73	1	93.47	2.11
B3L3PL5425	417	54	25	1	34.68	0.78
B3L3PL5449	815	54	49	1	67.88	1.53
B3L3PL5461	959	54	61	1	84.48	1.91
B3L3PL5473	1125	54	73	1	101.08	2.28

**B3L3PR • Right Gallery Panel End-of-Run 3-Way Return**

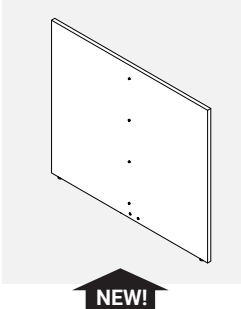

- Provides floor standing support while enclosing the end of a gallery panel run.
- Attaches to the Gallery Panel right edge with connectors to form an T configuration.
- Connections to Gallery Panel are on the interior face in the middle.
- Compatible with gallery panels (B3LEPxxxx, B3LSEPRxxxx, B3LMPxxxx and B3LXPRxxxx) only.
- Includes all attachment hardware and glides.
- Total height is inclusive of panel glides extended to their full height.
- 49" wide gallery panel accommodates two 24" deep surfaces while the 61" wide accommodates two 30" deep surface and 73" wide two 36" deep surface.
- Please specify LP laminate finish and PVC edge finish.
- If a wood grain laminate is chosen, grain direction run horizontally.
- Edged in PVC on three exposed edges and self edged on the bottom edge.

PRODUCT CODE	PRICE LP	SIZE /INCHES			WEIGHT LBS	VOL FT <sup>3</sup>
		H	W	D		
B3L3PR4225	333	42	25	1	26.87	0.61
B3L3PR4249	576	42	49	1	52.57	1.19
B3L3PR4261	764	42	61	1	65.41	1.48
B3L3PR4273	887	42	73	1	78.26	1.77
B3L3PR5025	417	50	25	1	32.08	0.72
B3L3PR5049	791	50	49	1	62.77	1.42
B3L3PR5061	930	50	61	1	78.12	1.77
B3L3PR5073	1091	50	73	1	93.47	2.11
B3L3PR5425	417	54	25	1	34.68	0.78
B3L3PR5449	815	54	49	1	67.88	1.53
B3L3PR5461	959	54	61	1	84.48	1.91
B3L3PR5473	1125	54	73	1	101.08	2.28

**B3HLPBB01 • Gallery Panel Bottom Inline Bracket**

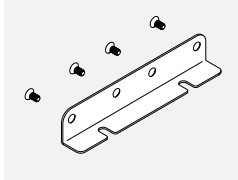

- Gallery Panel Bottom Inline Bracket connects two Gallery Panels at the bottom with screws.
- Available in standard paint colors.

PRODUCT CODE	PRICE	SIZE /INCHES			WEIGHT LBS	VOL FT <sup>3</sup>
		H	W	D		
B3HLPBB01	51	7	1.5	8	1	0.5

**B3HLPCB01 • Gallery Panel Corner Bracket**

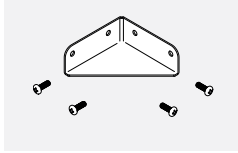

- Gallery Panel Corner Bottom bracket connects two Gallery Panels at 90 degrees.
- Available in standard paint colors.

PRODUCT CODE	PRICE	SIZE /INCHES			WEIGHT LBS	VOL FT <sup>3</sup>
		H	W	D		
B3HLPCB01	50	7	1.5	4	4	0.5

**B3PMP-GI-W • Privacy Glass for 1" Laminate Panels**

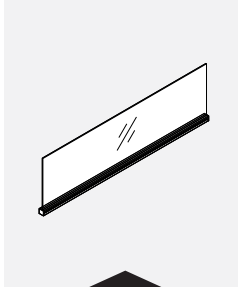

**NEW!**

- Privacy glass integrated with aluminum top trim.
- Attaches on top of gallery panels to add privacy or divide space.
- Includes aluminum trim with channel, end caps and glass tile.
- Top rail may also be used to hang accessories.
- Glass and attachment hardware ship separately.
- Please specify standard paint finish for the channel.
- Standard in clear (CLR) or frosted (FRST).

PRODUCT CODE	PRICE		SIZE /INCHES			WEIGHT LBS	VOL FT <sup>3</sup>
	CLR	FRST	H	W	D		
B3PMP24GI8W	290	356	8	24	1	4.84	0.11
B3PMP30GI8W	315	361	8	30	1	6.06	0.14
B3PMP36GI8W	335	368	8	36	1	7.28	0.17
B3PMP42GI8W	350	405	8	42	1	8.5	0.19
B3PMP48GI8W	369	440	8	48	1	9.72	0.22
B3PMP24GI16W	290	356	16	24	1	8.92	0.22
B3PMP30GI16W	315	361	16	30	1	11.17	0.28
B3PMP36GI16W	335	368	16	36	1	13.43	0.33
B3PMP42GI16W	350	405	16	42	1	15.68	0.39
B3PMP48GI16W	369	440	16	48	1	17.92	0.44

**B3PFD-W • Felt Divider for 1" Laminate Panels**

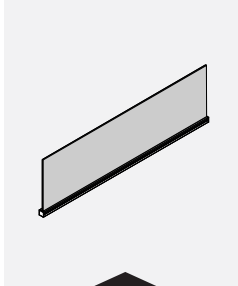

**NEW!**

- Privacy felt integrated with aluminum top trim.
- Attaches on top of gallery panels to add privacy or divide space.
- Includes aluminum trim with channel, end caps and felt tile.
- Top rail may also be used to hang accessories.
- Felt and attachment hardware ship separately.
- Please specify standard paint finish for the channel.
- Please specify standard felt finish.

PRODUCT CODE	PRICE	SIZE /INCHES			WEIGHT LBS	VOL FT <sup>3</sup>
		H	W	D		
B3PFD0824W	116	8	24	1	1.32	0.11
B3PFD0830W	135	8	30	1	1.65	0.14
B3PFD0836W	160	8	36	1	1.99	0.17
B3PFD0842W	180	8	42	1	2.32	0.19
B3PFD0848W	264	8	48	1	2.65	0.22
B3PFD0854W	289	8	54	1	2.98	0.25
B3PFD0860W	310	8	60	1	3.32	0.28
B3PFD0866W	327	8	66	1	3.65	0.31
B3PFD0872W	369	8	72	1	3.98	0.33
B3PFD1624W	132	16	24	1	1.83	0.22
B3PFD1630W	152	16	30	1	2.3	0.28
B3PFD1636W	170	16	36	1	2.76	0.33
B3PFD1642W	195	16	42	1	3.22	0.39
B3PFD1648W	290	16	48	1	3.68	0.44
B3PFD1654W	316	16	54	1	4.14	0.50
B3PFD1660W	338	16	60	1	4.61	0.56
B3PFD1666W	356	16	66	1	5.07	0.61
B3PFD1672W	405	16	72	1	5.53	0.67

**ELECTRICAL**

Affordability and widespread availability of wireless networking is gradually diminishing the need for extensive cable capacity housing. However, as our desk top equipment still requires electricity, providing access to power from within a work station is an integral part of any work place design.

The Teknion family of power components has been assembled to address a variety of common requirements as well as to satisfy specific customer needs and budgets.

Teknion can now offer the option of 3 duplex per panel, please contact your Customer Service Representative.

**Direct Access**

When office equipment plugs directly into a wall or raised floor power source, cable troughs, as well as the Boulevard panel internal cavity serve the purpose of organizing cables.

**Extensions**

Keeping minimal installation costs in mind, the next natural step is the employment of fused and surge protected power bars, worksurface-clamped receptacles or floor standing power towers.

**Four circuit power systems**

In the absence of a raised floor, or when office equipment is to be installed further away from wall outlets, the Boulevard panel the building power supply - office equipment gap by distributing power at either floor or desk height level, or both.

While Boulevard panels are capable of surrounding a given work station with power and data outlets at multiple levels, it is important to remember that the most economical way of providing four-circuit power distribution is if the harness, junction box and receptacle system remained within the central spine structure. The cost savings here come from a number and lengths of individual connecting power harnesses.

Should there be a need to branch power from Boulevard or central spine onto adjacent, perpendicular work surfaces, the employment of fused and surge protected power bars will assist in keeping the cost under control.

However, the very same, 4-circuit system is capable of delivering a considerable amount of power as there can be up to six, 8 wire-4 circuit systems accommodated within System 3 pass-thru panel. For instance: three systems at the floor level and two systems at the desk height.

Various ceiling or floor level power entry feeds are available. See the following pages for individual component description and technical specifications.

**TECHNICAL INFORMATION**

**Wire Schematic**

4-2-2 Wiring Schematic

8-Wire Shared Neutral

"3+1" -3 Utility circuits, 1 dedicated circuit.

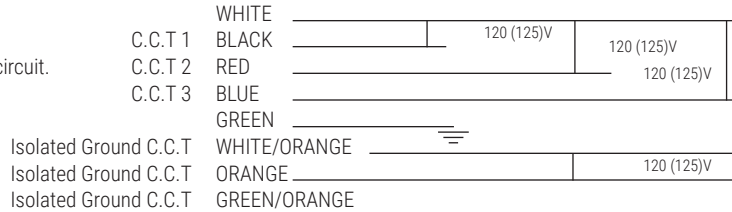

**8 Wires**

- 4 Lines (12 ga.)
- 2 Neutrals (10 ga.)
- 2 Grounds (12 ga.)

**4 Circuits**

- 3 Utility Circuits
- 1 Dedicated Circuits

**Receptacles**

Duplex – Up to 6 duplex receptacles per circuit (Up to 48 infeed)

**Specifications**

System rated for connection to a grounded 120/240 V, single phase\*, 20A, 60Hz or 120/208 V, 3 phase, 20A, 60Hz branch circuit for U.S. and 15A if product is marked with a C-UL Mark. Outlets rated 15A max.

\* When connected to Single Phase. Only Circuit 1,3 & A are available.

**UL Recognized CSA Certified**

**Warning:** It is recommended that installation of the electrical harness be made under the supervision of a licensed electrician in accordance with applicable codes and regulations.

**Special Note:** Always determine that harness is electrically connected to only one power supply.

**STEP-BY-STEP SPECIFICATION - 8 WIRE ELECTRICAL FOR BOULEVARD 1 AND RACEWAY PANELS**

**STEP 1:** Determine the location of the source power entry entering the panel through a post.

- a) From the floor:
  - i) Choose from a selection of single or double Base Feeds (BE81BF721, BE81BF722, BE81BF1441, BE81BF1442) to bring the power from the floor to the raceway channel.
  - ii) Select a post adjacent to the panel (or panels if using a Double Base Feed) to which the end of the Base Feed will be attached. This panel requires a Power Distribution Housing and must be located next to the post through which the Base Feed is entering.

**Note: If it is not practical to have a Power Distribution Housing in a panel adjacent to the selected Base Feed Post, use a BE8CPxxHJ Housing-to-Jumper Pass-Thru Cable to transition through the adjacent non-powered panel(s) that are between the Base Feed Post and the first powered panel. The length of the cable will equal the combined width of the non-powered panel(s).**

- b) From the Ceiling:
  - i) Choose from a selection of single or double Ceiling Feeds (BE81CF1201, BE81CF12a0-2, BE81CF1441, BE81CF1442) to bring the power from the ceiling to the raceway.
  - ii) Select a post adjacent to the panel (or panels if using a Double Ceiling Feed) to which the Ceiling Feed will be attached. This panel requires a Power Distribution Housing and must be located next to the post through which the Ceiling Feed is entering.

**STEP 2:** Determine which panels are to be powered.

- a) Use a BE81D Concealed Desk Height Power Distribution Housing or a BE8U2D Face-Mount Desk Height Power Distribution Housing that corresponds with the width of each panel selected to be powered.

**Note: Specify Face-Mount Raceway Covers for panels that contain BE8U2D Face-Mount Desk Height Power Distribution Housings.**

**STEP 3:** Connect power to the panels.

- a) Use a BE8JC16 Jumper between two adjacent powered panels.
- b) Use a BE8JC20 Jumper between two powered panels separated by a post.
- c) **Use a BE8JM19 Shielded Mesh Jumper between two powered panels separated by a post.**
- d) Use a BE8CPxxHJ Housing-to-Jumper Pass-Thru Cable to electrically connect a BE8JM19 Shielded Mesh Jumper and a powered panel when the two are separated by one or more non-powered panels in a straight line application only.
  - i) The length of the BE8CPxxHJ Housing-to-Jumper Pass-Thru Cable will equal the combined width of the non-powered panel(s).
- e) Use a BE8CPxxHH Housing-to-Housing Pass-Thru Cable to electrically connect two powered panel separated by one or more non-powered panels in a straight line application only.
  - i) The length of the Pass-Thru Cable corresponds with the width(s) of the non-powered panels that separate two powered panels plus 16" (the termination blocks of the Power Distribution Housing are 8" in from the edge of the powered panel), plus 4" for each post.
- f) Connect two jumpers or cables together by using the I-Connector BE8C11. This functions as a female-female adapter and it allows the male ends of jumpers and pass-thru cables to connect together.

**STEP 4:** Designate which circuit each duplex is to tap into.

- a) Each powered panel has four (4) potential locations for duplex receptacles - 2 per side. (Exception: 24" wide panel has only two (2) potential locations - 1 per side, 18" wide panel has no locations for receptacles).
- b) At each location there is a choice of four (4) circuit options. Select the circuit option for each location.

**Circuit Selections : Circuits 1, 2, and 3 are utility circuits, all sharing a ground and a neutral. Circuit A is a dedicated circuit with its own ground and neutral.**

**SPECIFICATION APPLICATIONS**

**Boulevard 1 Jumper Applications**

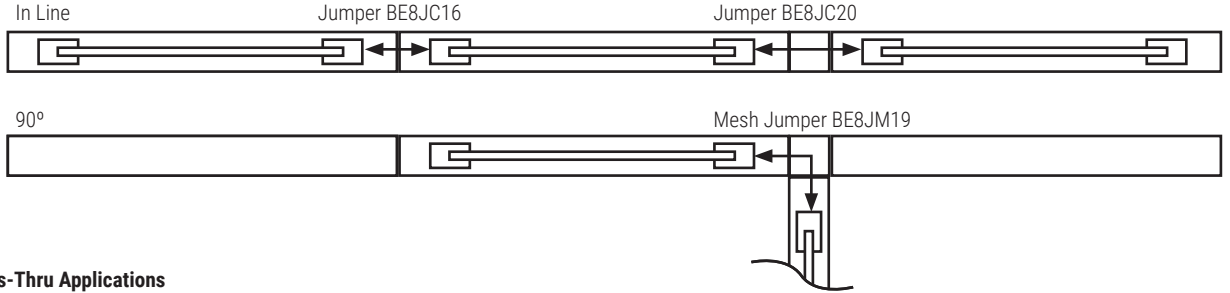

**Boulevard 1 Pass-Thru Applications**

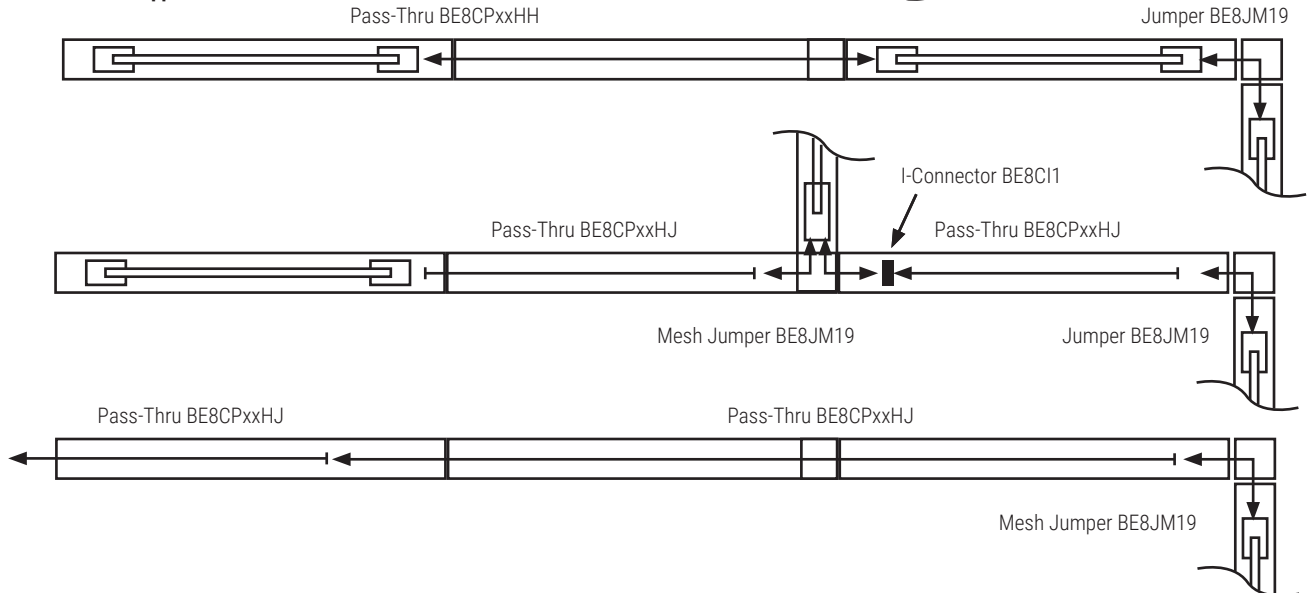

**STEP-BY-STEP SPECIFICATION - 8 WIRE ELECTRICAL FOR BOULEVARD SYSTEM 3 BASE RACEWAY**

**STEP 1:** Determine the location of the source power entry entering the panel.

- a. At the base of a panel:
  - i. Use a BE8BFxx Base Feed.
  - ii. Select the panel to which the Base Feed will be attached. This panel requires a BE83D Power Distribution Housing.
  - iii. Select the side of the panel and the receptacle outlet to which the Base Feed is to be attached.
- b. From the ceiling:
  - i. Use a BE8CFxx-1 or -2 (single or double).
  - ii. Select the post through which to feed the Ceiling Feed.
  - iii. One panel adjacent to the selected post requires a BE83D Power Distribution Housing. Attach the Ceiling Feed to the nearest end of the Power Distribution Housing.

**Note: If it is not practical to have a Power Distribution Housing in a panel adjacent to the selected Ceiling Feed Post, use a BE8CPxxHJ Housing-to-Jumper Pass-Thru Cable to transition through the adjacent non-powered panel(s) that are between the Ceiling Feed Post and the first powered panel. The length of the cable will equal the combined width of the non-powered panel(s).**

- c. At the base of an adjoining panel:
  - i. Use a BE83BFR72 Raceway Entry Base Feed
  - ii. Select a non-powered panel adjacent to the panel with a Power Distribution Housing.
  - iii. Choose a duplex opening on either side of the panel to insert and attach the Raceway Entry Base Feed at that point.
  - iv. The Raceway Entry Base Feed will attach to the nearest end of the Power Distribution Housing (similar to the Ceiling Feed attachment).

**STEP 2:** Determine which panels are to be powered.

- a. Use a BE83D Power Distribution Housing that corresponds with the width of the selected panel.

**STEP 3:** Connect power to the panels.

- a. Use a BE8JC16 Jumper between two adjacent powered panels.
- b. Use a BE8JC20 Jumper between two powered panels separated by a post.
- c. Use a BE8CPxxHH Housing-to-Housing Pass-Thru Cable to connect two powered panels separated by one or more non-powered panels. i. The length of the Pass-Thru Cable corresponds with the width(s) of the non-powered panels that separate two powered panels plus 16" (the termination blocks of the Power Distribution Housing are 8" in from the edge of the powered panel plus 4" for each post).

**STEP 4:** Designate which circuit each duplex is to tap into.

- a. Each powered panel has four (4) potential locations for duplex receptacles - 2 per side. (Exception: 24" wide panel has only two (2) potential locations - 1 per side, 18" wide panel has no locations for receptacles).
- b. At each location there is a choice of four (4) circuit options. Select the circuit option for each location.

**Circuit Selections : Circuits 1, 2, and 3 are utility circuits, all sharing a ground and a neutral. Circuit A is a dedicated circuit with its own ground and neutral.**

**SPECIFICATION APPLICATIONS**

**Boulevard System 3 Jumper Applications**

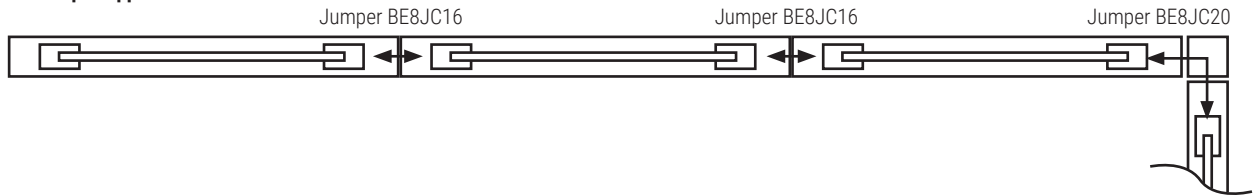

**Boulevard System 3 Jumper Applications**

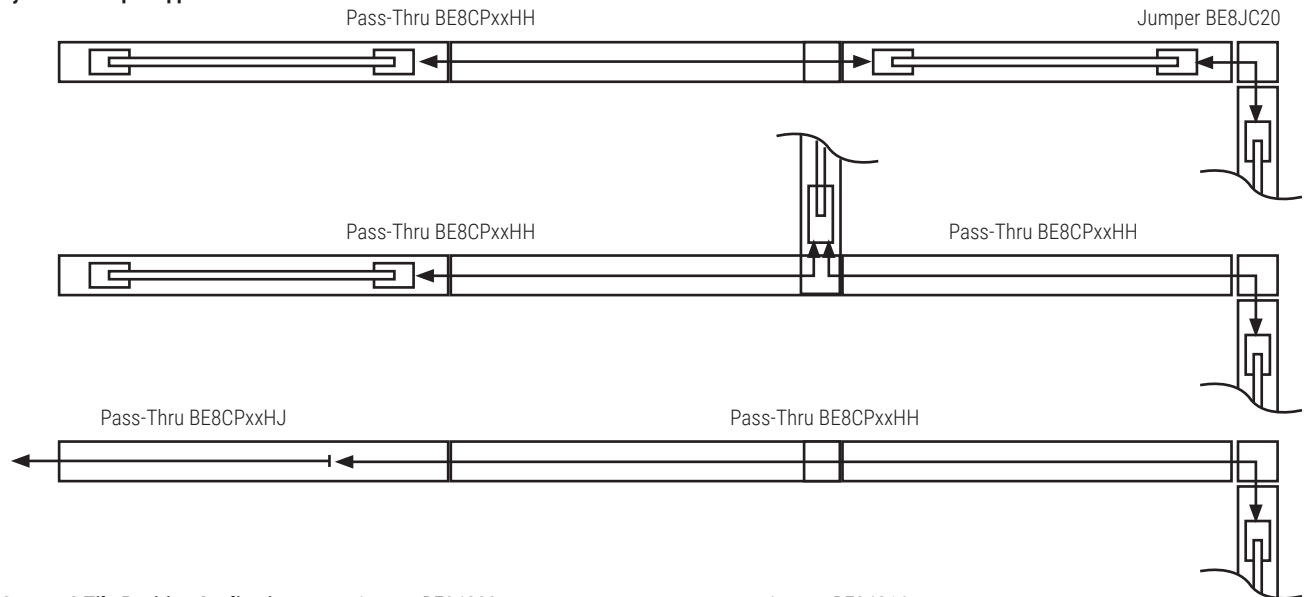

**Boulevard System 3 Tile Position Application**

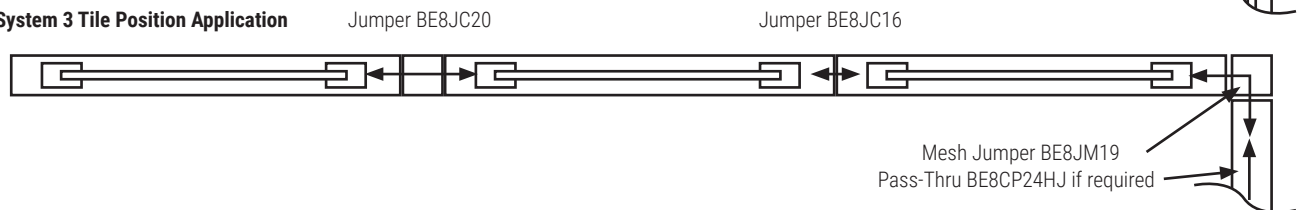

**BE8CI-1 • "I" Connector**

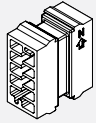

- Connects two Pass-Thru Cables.
- Inline coupler used to connect two BE8CPxxHH Pass-Thru Cables.

PRODUCT CODE	PRICE	SIZE / INCHES			WEIGHT VOL	
		H	W	D	LBS	FT <sup>3</sup>
BE8CI1	70	1.5	1.5	4.625	0.06	0.03

**BE8D • Duplex Receptacles**

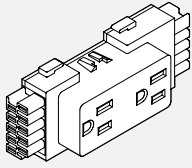

- Snaps into Power Distribution Housing.
- Up to 6 duplex receptacles per circuit.
- BE8D1 = Circuit #1 (utility circuit)
- BE8D2 = Circuit #2 (utility circuit)
- BE8D3 = Circuit #3 (utility circuit)
- BE8DA - Circuit #A (dedicated circuit)

PRODUCT CODE	PRICE	SIZE / INCHES			WEIGHT VOL	
		H	W	D	LBS	FT <sup>3</sup>
BE8D1	32	2	4.625	1.25	0.10	0.01
BE8D2	32	2	4.625	1.25	0.10	0.01
BE8D3	32	2	4.625	1.25	0.10	0.01
BE8DA	32	2	4.625	1.25	0.10	0.01

**BE8D • USB Receptacles**

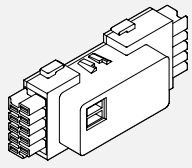

- Snaps into Power Distribution Housing.
- USB charging module provides convenient charging power access through dual ports on face of receptacles.
- Two USB ports.
- 2 amp output, considered as circuit #1.

PRODUCT CODE	PRICE	SIZE / INCHES			WEIGHT VOL	
		H	W	D	LBS	FT <sup>3</sup>
BE8DU1-B	269	2	4.625	1.25	0.10	0.01
BE8DU1-W	269	2	4.625	1.25	0.10	0.01

**BE83BF • Reversible Base Feed (Boulevard System 3 Only)**

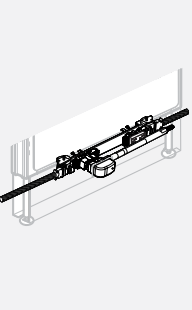

- Provides single power entry from floor circuit to raceway.
- Takes the place of a duplex receptacle by connecting to the base raceway channel of a Boulevard System 3 panel.
- BE83BF72 includes 72" long liquid-tight conduit, BE83BF144 includes 144" long liquid-tight conduit.
- Must be hard wired to power source by a licensed electrician.

PRODUCT CODE	PRICE	SIZE / INCHES			WEIGHT VOL	
		H	L	D	LBS	FT <sup>3</sup>
BE83BF72	314	3	72	3	3.82	2
BE83BF144	422	3	144	3	6.98	2

**BE83BFR72 • Raceway Entry Base Feed (Boulevard System 3 Only)**

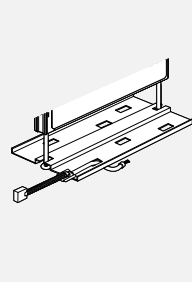

- Brings power to an adjacent panel by entering a non-powered raceway of a Boulevard System 3 panel through a duplex opening.
- Includes 72" long liquid-tight conduit.
- Must be hard wired to power source by a licensed electrician.

PRODUCT CODE	PRICE	SIZE / INCHES			WEIGHT VOL	
		H	L	D	LBS	FT <sup>3</sup>
BE83BFR72	446	3	88	3	4.82	2

**BE8CF-1 • Ceiling Feed - Single**

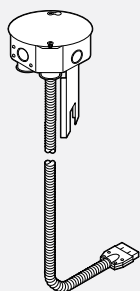

- Provides single power entry from ceiling, through post and into raceway channel.
- Power entry cable penetrates 8" into a panel and plugs into either a Power Distribution Housing or BE8CPxxHJ Pass-Thru Harness.
- Specify Post Extension separately.
- Must be hard wired to power source by a licensed electrician.

PRODUCT CODE	PRICE	SIZE / INCHES			WEIGHT VOL	
		H	L	D	LBS	FT <sup>3</sup>
BE8CF1201	308	6	120	6	5.24	2
BE8CF1441	349	6	144	6	5.96	2

**BE8CF-2 • Ceiling Feed - Double**

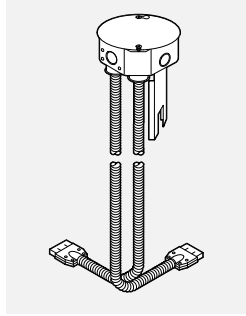

- Provides dual power entry from ceiling, through post and into raceway channel.
- Power entry cable penetrates 8" into a panel and plugs into either a Power Distribution Housing or a BE8CPxxHJ Pass-Thru Harness.
- Use 1) In middle of run to distribute power in two directions.  
2) At beginning of run where second Ceiling Feed harness is connected to BE8CPxxHJ and distributes power underneath Power Distribution Housing to pick-up second circuit grouping in long panel run.
- Specify Post Extension separately.
- Must be hard wired to power source by a licensed electrician.

PRODUCT CODE	PRICE	SIZE/INCHES			WEIGHT VOL	
		H	L	D	LBS	FT <sup>3</sup>
BE8CF1202	632	6	120	3	5.24	2
BE8CF1442	712	6	144	3	5.96	2

**BE81BF-1 • Base Feed - Single (Boulevard 1 Only)**

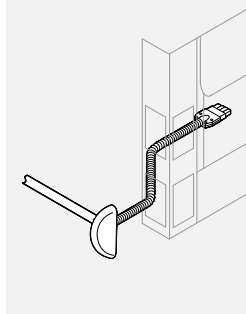

- Provides single power entry from floor, through post and into Boulevard 1 raceway channel.
- Power entry cable penetrates 8" into a panel and plugs into either a Power Distribution Housing or a BE8CPxxHJ Pass-Thru Harness.
- Power entry dome available in black only, but "Capture Strip" connector will match the post color as standard.
- 2 1/2" clearance in depth and 5 1/2" away from any obstructions required from power entry point.
- Comes with 32" harness attached. Liquid-tight whip 72" and 144".
- Must be hard wired to power source by a licensed electrician.

PRODUCT CODE	PRICE	SIZE/INCHES			WEIGHT VOL	
		H	L	D	LBS	FT <sup>3</sup>
BE81BF721	357	6	107	3	3.82	2
BE81BF1441	475	6	179	3	5.96	2

**BE81BF-1FL • Base Feed - Single (Boulevard 1 Only)**

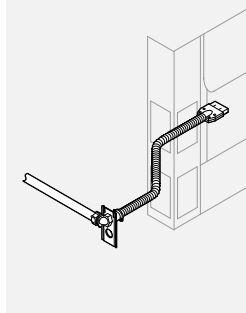

- Provides single power entry from floor, through post and into Boulevard 1 raceway channel.
- Power entry cable penetrates 8" into a panel and plugs into either a Power Distribution Housing or a BE8CPxxHJ Pass-Thru Harness.
- Power entry plate available in black only, but "Capture Strip" connector will match the post color as standard.
- 2 1/2" clearance in depth and 5 1/2" away from any obstructions required from power entry point.
- Comes with 32" harness attached. Liquid-tight whip 72" and 144".
- Must be hard wired to power source by a licensed electrician.

PRODUCT CODE	PRICE	SIZE/INCHES			WEIGHT VOL	
		H	L	D	LBS	FT <sup>3</sup>
BE81BF721FL	357	6	107	3	3.82	2
BE81BF1441FL	475	6	179	3	3.82	2

**BE81BF-2 • Base Feed - Double (Boulevard 1 Only)**

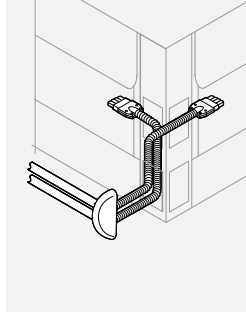

- Provides dual power entry from floor, through post and into Boulevard 1 raceway channel.
- Power entry cable penetrates 8" into a panel and plugs into either a Power Distribution Housing or a BE8CPxxHJ Pass-Thru Harness.
- Use 1) In middle-of-run to distribute power in two directions.  
2) At beginning of run where second Base Feed Harness is connected to BE8CPxxHJ and distributes power underneath Power Distribution Housing to pick-up second circuit grouping in long panel run.
- Liquid-tight whip 72" and 144".
- Power entry box available in black only, but "Capture Strip" connector will match the post color as standard.
- 2 1/2" clearance in depth and 5 1/2" away from any obstructions required from power entry point.
- Comes with 32" harness attached.
- Must be hard wired to power source by a licensed electrician.

PRODUCT CODE	PRICE	SIZE/INCHES			WEIGHT VOL	
		H	L	D	LBS	FT <sup>3</sup>
BE81BF722	756	6	107	3	6.98	2
BE81BF1442	1004	6	179	3	6.98	2

**BE81BF601 • Base Feed - Single (Boulevard 1 Only)**

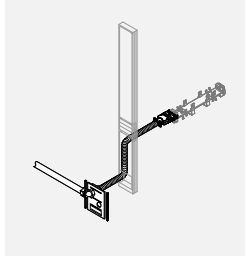

- Provides single power entry from floor, through 6" panel and into Boulevard 1 raceway panel.
- Power entry cable penetrates 8" into a panel and plugs into either a Power Distribution Housing or a BE8CPxxHJ Pass-Thru Harness.
- For 6" Power/Cable Access Panel only.
- Comes with 32" harness attached.
- Liquid-tight whip 72".
- Must be hard wired to power source by a licensed electrician.

PRODUCT CODE	PRICE	SIZE/INCHES			WEIGHT VOL	
		H	L	D	LBS	FT <sup>3</sup>
BE81BF601	385	6	107	3	4.90	0.062



**BE81BF602 • Base Feed - Double (Boulevard 1 Only)**

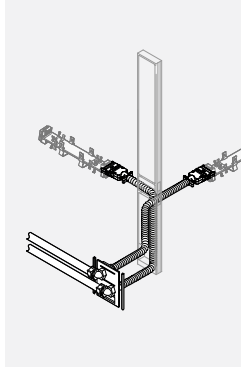

- Provides dual power entry from floor, through 6" panel and into Boulevard 1 raceway panel.
- Power entry cable penetrates 8" into a panel and plugs into either a Power Distribution Housing or a BE8CPxxHJ Pass-Thru Harness.
- Use 1. In middle-of-run to distribute power in two directions.
  2. At beginning of run where second Base Feed Harness is connected to BE8CPxxHJ and distributes power underneath Power Distribution Housing to pick-up second circuit grouping in long panel run.
- For 6" Power/Cable Access Panel only.
- Comes with 2" x 32" harness attached.
- Liquid-tight whip 72".
- Must be hard wired to power source by a licensed electrician.

PRODUCT CODE	PRICE	SIZE/INCHES			WEIGHT VOL	
		H	L	D	LBS	FT <sup>3</sup>
BE81BF602	775	6	107	3	5.30	0.071

**BE8JC • Jumper Cable**

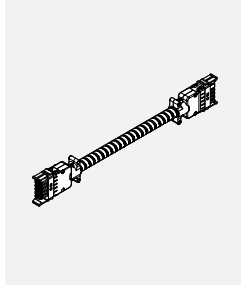

- Electrically connects two Power Distribution Housings.
- The BE8JC16 electrically connects two powered panels positioned side by side.
- The BE8JC20 electrically connects two powered panels separated by a post.
- Wires are concealed in a flexible metal conduit.
- Cannot go through a Boulevard 1 post in a corner application. (Please use the Jumper Cable Mesh)

PRODUCT CODE	PRICE	SIZE/INCHES			WEIGHT VOL	
		H	L	D	LBS	FT <sup>3</sup>
BE8JC16	130	2	16.75	0.5	0.66	1.17
BE8JC20	136	2	20.75	0.5	0.78	1.17

**BE8JM19 • Jumper Cable Mesh**

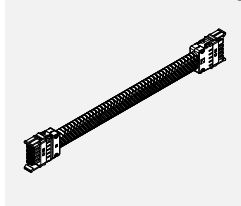

- Electrically connects two Power Distribution Housings in Boulevard 1 panels that are separated by a post in a corner application.
- BE8JM19 - Wires are covered with a durable nylon mesh.
- BE8JMS19 - Wires are concealed in a flexible metal shroud and covered with a durable nylon mesh.
- Used in System 3 Panels at tile position passing through post at corner application.

PRODUCT CODE	PRICE	SIZE/INCHES			WEIGHT VOL	
		H	L	D	LBS	FT <sup>3</sup>
BE8JM19	108	2	19	0.5	0.75	1.17
BE8JMS19	140	2	19	0.5	0.75	1.17

**BE83BT • Base-to-Tile Cable**

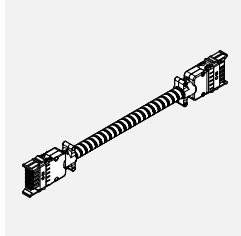

- Electrically connects a Base Raceway Power Distribution Housing to a Face-Mount Tile Power Distribution Housing within a System 3 PV panel.
- Wires are concealed in a flexible metal conduit.
- BE83BT82 to be used on panels manufactured before November 1st, 2014 and BE83BT40 after.

PRODUCT CODE	PRICE	SIZE/INCHES			WEIGHT VOL	
		H	L	D	LBS	FT <sup>3</sup>
BE83BT82	199	2	82.5	0.5	3.05	1.38
BE83BT40	179	2	40.5	0.5	1.44	1.17

**BE8CP-HH • Housing-to-Housing Pass-Thru Cable**

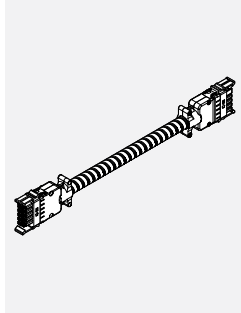

- Electrically connects two Power Distribution Housings in panels separated by one or more non-powered panels.
- Wires are concealed in a flexible metal conduit.
- NOTE : In Boulevard 1 and or System 3 tile position applications, the Housing-to-Housing Pass-Thru Cables can only be used in a straight run.

PRODUCT CODE	PRICE	SIZE/INCHES			WEIGHT VOL	
		H	L	D	LBS	FT <sup>3</sup>
BE8CP40HH	163	2	40.5	0.5	1.44	1.17
BE8CP46HH	171	2	46.5	0.5	1.71	1.17
BE8CP52HH	178	2	52.5	0.5	1.95	1.17
BE8CP58HH	187	2	58.5	0.5	2.21	1.17
BE8CP64HH	194	2	64.5	0.5	2.37	1.17
BE8CP70HH	201	2	70.5	0.5	2.6	1.17
BE8CP76HH	209	2	76.5	0.5	2.81	1.17
BE8CP82HH	215	2	82.5	0.5	3.03	1.17
BE8CP88HH	222	2	88.5	0.5	3.05	1.17
BE8CP94HH	230	2	94.5	0.5	3.30	1.17
BE8CP100HH	237	2	100.5	0.5	3.47	1.17
BE8CP106HH	247	2	106.5	0.5	3.87	1.17
BE8CP118HH	260	2	118.5	0.5	4.08	1.17
BE8CP130HH	275	2	130.5	0.5	4.73	1.17
BE8CP142HH	290	2	142.5	0.5	4.99	1.17

**BE8CP-HJ • Housing-to-Jumper Pass-Thru Cable**

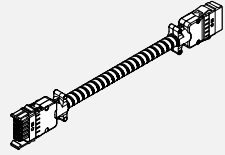

- Electrically connects a Power Distribution Housing to a Housing connection of a harness.
- Wires are concealed in a flexible metal conduit.
- NOTE : In both Boulevard 1 and System 3 Tile Position applications, the Housing-to-Jumper Pass-Thru Cables can only be used in a straight run.

PRODUCT CODE	PRICE	SIZE/INCHES			WEIGHT VOL	
		H	L	D	LBS	FT <sup>3</sup>
BE8CP24HJ	125	2	24	0.5	0.9	1.17
BE8CP30HJ	134	2	30	0.5	1.3	1.17
BE8CP36HJ	140	2	36	0.5	1.44	1.17
BE8CP42HJ	146	2	42	0.5	1.71	1.17
BE8CP48HJ	153	2	48	0.5	1.95	1.17
BE8CP54HJ	158	2	54	0.5	2.21	1.17
BE8CP60HJ	163	2	60	0.5	2.37	1.17
BE8CP72HJ	174	2	72	0.5	2.81	1.17
BE8CP84HJ	190	2	84	0.5	3.05	1.17
BE8CP96HJ	203	2	96	0.5	3.3	1.17
BE8CP108HJ	215	2	108	0.5	3.87	1.17
BE8CP120HJ	228	2	120	0.5	4.08	1.17
BE8CP144HJ	242	2	144	0.5	4.59	1.17

**BE81D • Power Distribution Housing Kit - Concealed Desk Height (Boulevard 1 Only)**

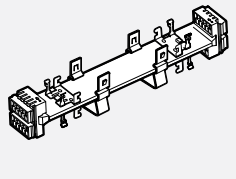

- Provides two duplex receptacles per panel for all panel widths above 24" wide.
- Power Distribution Housing is specified per panel size. eg. BE81D36 is for use with a 36" panel.

PRODUCT CODE	PRICE	SIZE/INCHES			WEIGHT VOL	
		H	L	D	LBS	FT <sup>3</sup>
BE81D24	134	2	9.25	2.61	0.83	1.17
BE81D30	166	2	15.25	2.61	1.28	1.17
BE81D36	174	2	21.25	2.61	1.62	1.65
BE81D42	188	2	27.25	2.61	2.00	2.00
BE81D48	198	2	33.25	2.61	2.32	2.54
BE81D54	207	2	39.25	2.61	2.66	3.20
BE81D60	212	2	45.25	2.61	3.04	3.20
BE81D66	368	2	51.25	2.61	3.49	3.25
BE81D72	368	2	57.2	2.61	3.76	3.30

**BE8U2D • Power Distribution Housing Kit - Face-Mount Desk Height (Boulevard 1 Only)**

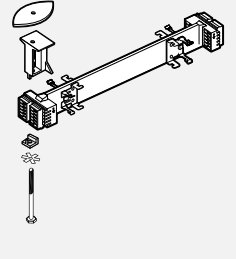

- Provides two duplex receptacles per panel side for all panel widths above 24" wide.
- Power Distribution Housing is specified per panel size. eg. BE8U2D36 is for use with a 36" panel.
- 24" wide panel allows for only one (1) duplex receptacle per panel side.

PRODUCT CODE	PRICE	SIZE/INCHES			WEIGHT VOL	
		H	L	D	LBS	FT <sup>3</sup>
BE8U2D24	166	2	9.25	2.61	0.83	1.17
BE8U2D30	191	2	15.25	2.61	1.28	1.17
BE8U2D36	201	2	21.25	2.61	1.62	1.65
BE8U2D42	212	2	27.25	2.61	2.00	2.00
BE8U2D48	221	2	33.25	2.61	2.32	2.54
BE8U2D54	231	2	39.25	2.61	2.66	3.20
BE8U2D60	237	2	45.25	2.61	3.04	3.20
BE8U2D66	368	2	51.25	2.61	3.49	3.25
BE8U2D72	368	2	57.25	2.61	3.76	3.30

**BE83D • Power Distribution Housing Kit - Base Raceway (Boulevard System 3 Only)**

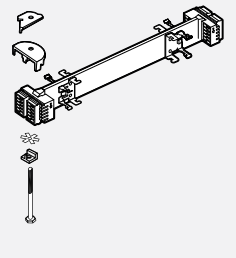

- Provides two duplex receptacles per panel side for all panel widths above 24" wide.
- Power Distribution Housing is specified per panel size. eg. BE83D36 is for use with a 36" panel.
- 24" wide panel allows for only one (1) duplex receptacle per panel side.

PRODUCT CODE	PRICE	SIZE/INCHES			WEIGHT VOL	
		H	L	D	LBS	FT <sup>3</sup>
BE83D24	166	2	9.25	2.61	0.83	1.17
BE83D30	191	2	15.25	2.61	1.28	1.17
BE83D36	201	2	21.25	2.61	1.62	1.65
BE83D42	212	2	27.25	2.61	2.00	2.00
BE83D48	221	2	33.25	2.61	2.32	2.54
BE83D54	228	2	39.25	2.61	2.66	3.20
BE83D60	237	2	45.25	2.61	3.04	3.20
BE83D66	368	2	51.25	2.61	3.49	3.25
BE83D72	368	2	57.25	2.61	3.76	3.30

**BE8U3FM • Power Distribution Housing Kit - Face-Mount Tile (Boulevard System 3 Only)**

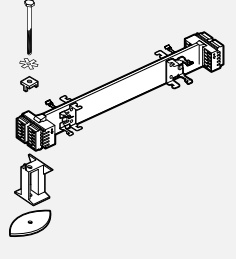

- Provides two duplex receptacles for all tile widths above 24". 24" wide tile allows for one (1) duplex receptacle.
- Housing and mounting hardware included.
- Specify duplexes, cables and tiles separately.
- BE83BT40 Base-to-Tile Cable is used to connect the tile mounted housing to the Power Distribution Housing tile in the base of the same "PV" panel.
- 24" wide tiles have one duplex and one data/comm opening. 30" and wider tiles have two data/comm openings.
- Note: Not compatible with panels built prior November 1st, 2014.

PRODUCT CODE	PRICE	SIZE/INCHES			WEIGHT VOL	
		H	L	D	LBS	FT <sup>3</sup>
BE8U3FM24	166	2	9.25	2.61	0.83	1.17
BE8U3FM30	191	2	15.25	2.61	1.28	1.17
BE8U3FM36	201	2	21.25	2.61	1.62	1.65
BE8U3FM42	212	2	27.25	2.61	2.00	2.00
BE8U3FM48	221	2	33.25	2.61	2.32	2.54
BE8U3FM54	228	2	39.25	2.61	2.66	3.20
BE8U3FM60	237	2	45.25	2.61	3.04	3.20
BE8U3FM66	368	2	51.25	2.61	3.49	3.25
BE8U3FM72	368	2	57.25	2.61	3.76	3.30

**BE81D-CM • Center Mount Power Distribution Housing Quad Kit - Concealed Desk Height (B1 Only)**

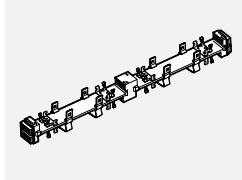

- Provides four duplex receptacles per panel for widths 36" and above.
- Center Mount Distribution Housing is specified per panel size. ie. BE81D36CM is for 36" panel.
- Not available for panels less than 36" wide.

PRODUCT CODE	PRICE	SIZE/INCHES			WEIGHT VOL	
		H	L	D	LBS	FT <sup>3</sup>
BE81D36CM	299	2	21.99	2.61	3.24	1.65
BE81D42CM	352	2	27.99	2.61	4.00	2.00
BE81D48CM	368	2	33.99	2.61	4.64	2.54
BE81D54CM	384	2	39.99	2.61	5.32	3.20
BE81D60CM	403	2	45.99	2.61	6.04	3.20
BE81D66CM	551	2	51.99	2.61	6.98	3.25
BE81D72CM	571	2	57.99	2.61	7.52	3.30

**BEPE • Post Extension**

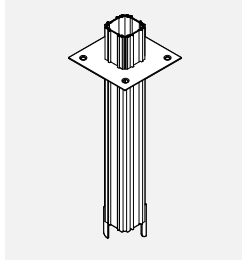

- Lightweight aluminum pole to be used to bring power and/or data/communication cables from ceiling to a panel through a post.
- Attaches to ceiling and post.
- Includes connectors, ceiling trim plate and screws.
- Post extension will accept:  
75 cables 5.6 mm (0.220") dia. data cables  
60 cables 5.6 mm (0.220") dia. data cables with 1 power feed  
45 cables 5.6 mm (0.220") dia. data cables with 2 power feeds.
- Ceiling bezel is white only.

PRODUCT CODE	PRICE	SIZE/INCHES			WEIGHT VOL	
		L	D	LBS	FT <sup>3</sup>	
BEPE49	95	49	2.61	5.00	0.258	
BEPE81	144	81	2.61	9.00	0.424	

**BHPOST • Lay-In Post Extension**

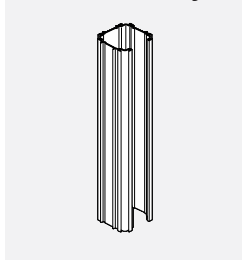

- Three sided lightweight aluminum pole to be used to bring power and/or data/communication cables from ceiling to a panel. True lay-in application use
- Attaches to ceiling and post.
- Includes connectors and ceiling bezel plate and screws.
- Requires vertical end trim to enclose when used in 2 way and 3 way panel run application.
- Trim encloses lay-in cable post extension, sold separately.

PRODUCT CODE	PRICE	TYPE	SIZE/INCHES			WEIGHT VOL	
			H	L	D	LBS	FT <sup>3</sup>
BHPOST66	209	BASE	66	2.61	2.61	8	0.346
BHPOSTE30	71	EXTENSION	30	2.61	2.61	5	0.195
BHPOSTE78	179	EXTENSION	78	2.61	2.61	9	0.430

**BE2PE • Off-Module Post Extension**

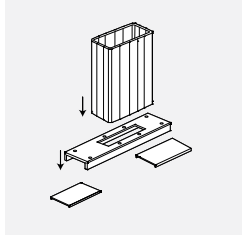

- An alternative to the existing Ceiling Post, allows for an off-module Ceiling Feed location.
- Attaches to the top of horizontal trim.
- Panel ceiling post consists of two aluminum extrusions for a true lay-in application.
- Includes brackets, hardware and ceiling trim plate and screws.
- Harness length will vary in length depending on post location along the panel.
- Can only be used with Boulevard System 3 "PV" and "MV" Panels.
- Requires on site cutting of top trim for placement along panel.

PRODUCT CODE	PRICE	SIZE/INCHES			WEIGHT VOL	
		H	L	D	LBS	FT <sup>3</sup>
BE2PE49	214	49	7.61	3.00	5	0.258
BE2PE81	318	81	7.61	3.00	9	0.424

**DEK • Jumper Harness**

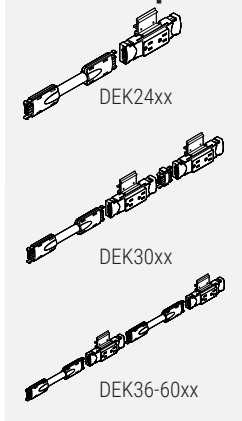

- Kit includes all components to add power to Diet Panels.
- Typical kit includes: 2 Duplex Receptacle Blocks (either circuit #1 or circuit #2), the Jumper Harness between the Duplex Receptacle Blocks, the Jumper Harness to the next panel, the pre-punched Raceway Cover, the aluminum Raceway Junction Cover, 2 PVC Duplex Receptacle Block Spacers and the hardware to attach the components.
- The length of the Jumper Harness between two Duplex Receptacle Blocks is based on the panel width.
- Jumper Harness going into the next panel and the aluminum Raceway Junction Covers are standard size.
- Raceway Cover and Raceway Junction Cover are Charcoal (CHR) only.
- Each kit is identified as circuit #1 (ie. DEK240"1") or circuit #2 (ie. DEK240"2").
- 24" wide panels have a single Duplex Receptacle Block only.
- 30" wide panels have 2 Duplex Receptacle Blocks, however they must be facing the same direction.
- 24" and 30" wide panels are not pre-punched for data.
- 36" to 60" wide panels are pre-punched for Duplex Receptacle Blocks on either side and for data just off-center on both sides.

PRODUCT CODE	PRICE	SIZE/INCHES			WEIGHT VOL	
		H	W	D	LBS	FT <sup>3</sup>
DEK2401	266	4	18	1.3	4.90	0.07
DEK3001	389	4	24	1.3	5.25	0.08
DEK3601	408	4	30	1.3	5.70	0.10
DEK4201	422	4	36	1.3	6.00	0.13
DEK4801	441	4	42	1.3	6.40	0.15
DEK5401	463	4	48	1.3	7.10	0.16
DEK6001	481	4	54	1.3	7.60	0.19
DEK2402	266	4	18	1.3	4.90	0.07
DEK3002	389	4	24	1.3	5.25	0.08
DEK3602	408	4	30	1.3	5.70	0.10
DEK4202	422	4	36	1.3	6.00	0.13
DEK4802	441	4	42	1.3	6.40	0.15
DEK5402	463	4	48	1.3	7.10	0.16
DEK6002	481	4	54	1.3	7.60	0.19

**DEJH • Diet Pass-Thru Kit**

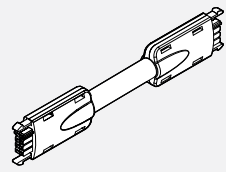

- Kit allows electrical to pass through a Diet Panel.
- Kit includes: female-female jumper harness, Raceway Cover and Raceway Junction Cover.
- Pass-Thru harness connects to a Duplex Receptacle Block within one powered panel; passes through a non-powered panel, and the opposite end connects to another Receptacle Block within the second powered panel.
- Raceway Cover and Raceway Junction Cover are Charcoal (CHR) only.

PRODUCT CODE	PRICE	SIZE / INCHES			WEIGHT VOL	
		H	L	D	LBS	FT <sup>3</sup>
DEJH24	182	2	42	1	1.81	0.025
DEJH30	207	2	48	1	2.07	0.028
DEJH36	226	2	54	1	2.12	0.032
DEJH42	245	2	60	1	2.60	0.035
DEJH48	263	2	66	1	2.86	0.038
DEJH54	284	2	72	1	3.13	0.041
DEJH60	301	2	78	1	3.39	0.044

**DEBF • Diet Base Feed**

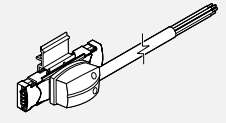

- Provides single power entry from floor into raceway.
- Single Ceiling Feed has a 6' whip, liquid tight.
- Raceway connection replaces one Duplex Receptacle Block in a standard kit.

PRODUCT CODE	PRICE	SIZE / INCHES			WEIGHT VOL	
		H	L	D	LBS	FT <sup>3</sup>
DEBF01	228	2	72	2	5.6	0.06

**DECF • Diet Ceiling Feed**

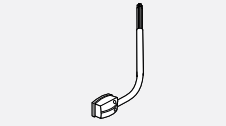

- Provides single power entry from ceiling through a post into raceway.
- Raceway connection replaces one Duplex Receptacle Block in a standard kit.

PRODUCT CODE	PRICE	SIZE / INCHES			WEIGHT VOL	
		H	L	D	LBS	FT <sup>3</sup>
DECF01	371	2	144	2	5.6	0.06

**DEPE • Diet Post Extension**



- Lightweight aluminum pole manages power and data cables between ceiling and floor level raceway.
- Aluminum extrusion with PVC extruded cover secures to the outside of the panel and passes through the worksurface scoop.
- Includes all hardware and bezel.
- Intended for use on Diet panels with fabric bottoms.

PRODUCT CODE	PRICE	SIZE / INCHES			WEIGHT VOL	
		H	W	D	LBS	FT <sup>3</sup>
DEPE116	255	116	4.5	1	7	0.82

**DERJC • Raceway Junction Cover**

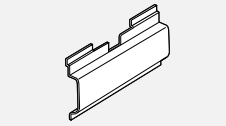

- Provides an external cover for cables passing between adjacent, in-line panels and off-module "X" panel configurations. Also, capable of bridging two in-line panels in a "T" configuration (outside).
- Aluminum, powder coated finish.

PRODUCT CODE	PRICE	SIZE / INCHES			WEIGHT VOL	
		H	W	D	LBS	FT <sup>3</sup>
DERJC	25	4.3	10	1	0.5	0.1

**WORKSURFACES**

Teknion offers a wide variety of worksurfaces and user friendly worksurface shapes to support a variety of tasks, applications and personal preferences.

High and Low pressure worksurfaces are 3 mm edge banded.  
Wood veneer surfaces or solid wood edges available.

1 1/16" particle board.

45 lb. density

100% recycled from post consumer industrial material

"Scoops" for cable management.

All worksurfaces have threaded inserts for metal-to-metal connection of support hardware.

**TECHNICAL INFORMATION****Worksurfaces**

All worksurfaces have threaded inserts for metal-to-metal connection of support hardware.

Back edge features scoop detail.

Worksurfaces 48" or less have one scoop while those that are 54" or more have a double scoop feature with a 1/2" wire passage trough between the scoops.

LP and HP worksurfaces are 3 mm edge banded.

LP worksurfaces are 1" thick particle board with laminate finish.

HP worksurfaces are 1 1/16" thick particle board with laminate finish.

T worksurfaces are 1 1/16" thick particle board with laminate finish and wood trim.

W worksurfaces are 1 3/16" thick particle board with wood veneer finish. Edge is solid wood edge banded.

One universal cantilever supports two abutting worksurfaces.

20" deep worksurfaces available at same price as 24" deep worksurfaces.

Support hardware must be ordered separately.

Edge banded worksurfaces without scoops available, substitute "NFL" for "SCP" at the end of the code.

**Transaction Worksurfaces**

To install transaction worksurfaces to a 42" high panel, use BHBT02 bracket.

To install transaction worksurfaces to a 37" high panel, use BHBT37 bracket.

**BWS • Straight Rectangular Worksurface With Scoop**

- Straight rectangular worksurfaces are non-handed and can be interchanged on site.
- Please choose from DWT - Designer White, SIL - Silver or BLK - Black for scoop covers.

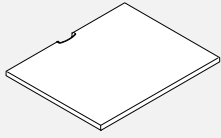

Worksurfaces 54" or Less

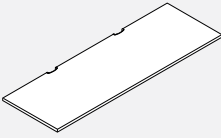

Worksurfaces 60" or Longer

PRODUCT CODE	PRICE LP*	GROUP			SIZE / INCHES			WEIGHT VOL	
		HP*	T*	W*	H	W	D	LBS	FT <sup>3</sup>
BWS1818P	119	151	218	331	1	18	18	9	0.29
BWS1824P	130	163	244	409	1	24	18	12	0.39
BWS1830P	139	173	258	498	1	30	18	15	0.49
BWS1836P	157	196	288	587	1	36	18	18	0.59
BWS1842P	209	258	361	706	1	42	18	21	0.68
BWS1848P	247	308	414	741	1	48	18	24	0.78
BWS1854P	287	361	475	754	1	54	18	27	0.88
BWS1860P	318	395	518	778	1	60	18	30	1.00
BWS1866P	339	423	552	802	1	66	18	32	1.10
BWS1872P	357	446	588	826	1	72	18	35	1.20
BWS1878P	377	471	621	898	1	78	18	38	1.30
BWS1884P	409	511	676	937	1	84	18	41	1.40
BWS2418P	123	155	244	382	1	18	24	12	0.40
BWS2424P	134	166	258	473	1	24	24	16	0.52
BWS2430P	141	176	277	579	1	30	24	20	0.65
BWS2436P	161	201	312	676	1	36	24	23	0.78
BWS2442P	210	261	378	810	1	42	24	28	0.90
BWS2448P	252	314	437	898	1	48	24	31	1.03
BWS2454P	295	368	503	923	1	54	24	35	1.20
BWS2460P	333	414	554	946	1	60	24	39	1.30
BWS2466P	345	433	581	986	1	66	24	43	1.41
BWS2472P	362	452	605	1021	1	72	24	47	1.54
BWS2478P	384	480	652	1124	1	78	24	51	1.70
BWS2484P	414	518	697	1213	1	84	24	55	1.80
BWS3018P	144	178	280	475	1	18	30	15	0.50
BWS3024P	155	194	302	594	1	24	30	20	0.70
BWS3030P	168	211	330	702	1	30	30	25	0.97
BWS3036P	198	248	372	831	1	36	30	30	1.06
BWS3042P	280	350	477	870	1	42	30	34	1.12
BWS3048P	295	368	509	939	1	48	30	39	1.30
BWS3054P	323	405	552	975	1	54	30	44	1.44
BWS3060P	345	433	587	1014	1	60	30	49	1.60
BWS3066P	361	448	612	1092	1	66	30	54	1.80
BWS3072P	381	476	648	1176	1	72	30	59	2.00
BWS3078P	404	504	686	1297	1	78	30	64	2.10
BWS3084P	446	557	751	1398	1	84	30	69	2.24
BWS3672P	724	949	1480	2373	1	72	36	71	2.30

LP = Thermally Fused Laminate, HP = High Pressure Laminate, T= High Pressure Laminate with Wood Trim, W= Wood Veneer

**BWSP • Straight Rectangular Worksurface to Span a Post With Scoop**

- Straight rectangular worksurfaces are non-handed and can be interchanged on site.
- Worksurface will span the width of a post eliminating a gap between standard sizes.
- Please choose from DWT - Designer White, SIL - Silver or BLK - Black for scoop covers.

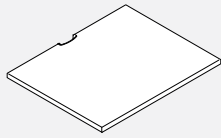

Worksurfaces 57" or Less

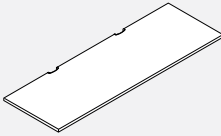

Worksurfaces 63" or Longer

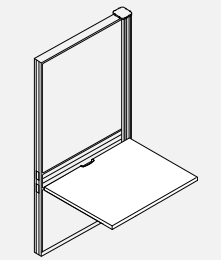

Application of Worksurface

PRODUCT CODE	PRICE LP*	GROUP			SIZE / INCHES			WEIGHT VOL	
		HP*	T*	W*	H	W	D	LBS	FT <sup>3</sup>
BWSP1821P	130	163	242	408	1	21	18	10	0.34
BWSP1827P	139	172	258	497	1	27	18	13	0.44
BWSP1833P	157	196	287	583	1	33	18	16	0.53
BWSP1839P	207	258	360	702	1	39	18	19	0.63
BWSP1845P	245	304	411	736	1	45	18	22	0.72
BWSP1851P	286	360	474	751	1	51	18	25	0.82
BWSP1857P	318	395	518	778	1	57	18	28	0.92
BWSP1863P	338	421	549	795	1	63	18	31	1.01
BWSP1869P	356	444	584	822	1	69	18	34	1.11
BWSP1875P	385	469	619	895	1	75	18	37	1.21
BWSP1881P	406	509	670	930	1	81	18	40	1.30
BWSP1887P	438	547	761	1038	1	87	18	43	1.40
BWSP2421P	134	166	258	473	1	21	24	14	0.45
BWSP2427P	141	176	277	579	1	27	24	17	0.60
BWSP2433P	161	201	312	676	1	33	24	21	0.70
BWSP2439P	210	261	378	810	1	39	24	25	0.83
BWSP2445P	252	314	437	898	1	45	24	29	1.00
BWSP2451P	295	368	503	923	1	51	24	33	1.10
BWSP2457P	333	414	554	946	1	57	24	37	1.22
BWSP2463P	345	433	581	986	1	63	24	41	1.34
BWSP2469P	362	452	605	1021	1	69	24	45	1.47
BWSP2475P	384	480	652	1124	1	75	24	49	1.60
BWSP2481P	414	518	697	1213	1	81	24	53	1.73
BWSP2487P	522	654	786	1295	1	87	24	57	1.90
BWSP3021P	155	194	302	594	1	21	30	17	0.56
BWSP3027P	168	211	330	702	1	27	30	22	0.72
BWSP3033P	198	248	372	831	1	33	30	27	0.88
BWSP3039P	280	350	477	870	1	39	30	32	1.04
BWSP3045P	295	368	509	939	1	45	30	37	1.20
BWSP3051P	323	405	552	975	1	51	30	41	1.40
BWSP3057P	345	433	587	1014	1	57	30	46	1.51
BWSP3063P	361	448	612	1092	1	63	30	51	1.67
BWSP3069P	381	476	648	1176	1	69	30	56	1.83
BWSP3075P	404	504	686	1297	1	75	30	61	2.00
BWSP3081P	446	557	751	1398	1	81	30	66	2.20
BWSP3087P	598	748	946	1501	1	87	30	70	2.30
BWSP3675P	741	972	1480	2373	1	75	36	73	2.40

LP = Thermally Fused Laminate, HP = High Pressure Laminate, T= High Pressure Laminate with Wood Trim, W= Wood Veneer

**BWS • Straight Rectangular Worksurface**

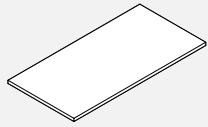

- Straight rectangular worksurfaces are non-handed and can be interchanged on site.
- Worksurface features no scoop or flex lip.

PRODUCT CODE	PRICE LP*	GROUP			SIZE/INCHES			WEIGHT VOL	
		HP*	T*	W*	H	W	D	LBS	FT <sup>3</sup>
BWS1818NFL	119	151	218	331	1	18	18	9	0.28
BWS1824NFL	130	163	244	409	1	24	18	12	0.40
BWS1830NFL	139	173	258	498	1	30	18	15	0.50
BWS1836NFL	157	196	288	587	1	36	18	18	0.59
BWS1842NFL	209	258	361	706	1	42	18	21	0.68
BWS1848NFL	247	308	414	741	1	48	18	24	0.78
BWS1854NFL	287	361	475	754	1	54	18	27	0.88
BWS1860NFL	318	395	518	778	1	60	18	29	0.97
BWS1866NFL	339	423	552	802	1	66	18	32	1.10
BWS1872NFL	357	446	588	826	1	72	18	35	1.20
BWS1878NFL	377	471	621	898	1	78	18	38	1.30
BWS1884NFL	409	511	676	937	1	84	18	41	1.40
BWS2418NFL	123	155	244	382	1	18	24	12	0.40
BWS2424NFL	134	166	258	473	1	24	24	16	0.52
BWS2430NFL	141	176	277	579	1	30	24	20	0.65
BWS2436NFL	161	201	312	676	1	36	24	24	0.78
BWS2442NFL	210	261	378	810	1	42	24	28	0.90
BWS2448NFL	252	314	437	898	1	48	24	31	1.03
BWS2454NFL	295	368	503	923	1	54	24	35	1.20
BWS2460NFL	333	414	554	946	1	60	24	39	1.30
BWS2466NFL	345	433	581	986	1	66	24	43	1.41
BWS2472NFL	362	452	605	1021	1	72	24	47	1.54
BWS2478NFL	384	480	652	1124	1	78	24	51	1.70
BWS2484NFL	414	518	697	1213	1	84	24	55	1.80
BWS3018NFL	144	178	280	475	1	18	30	15	0.50
BWS3024NFL	155	194	302	594	1	24	30	20	0.65
BWS3030NFL	168	211	330	702	1	30	30	25	0.81
BWS3036NFL	198	248	372	831	1	36	30	29	1.00
BWS3042NFL	280	350	477	870	1	42	30	34	1.13
BWS3048NFL	295	368	509	939	1	48	30	39	1.30
BWS3054NFL	323	405	552	975	1	54	30	44	1.44
BWS3060NFL	345	433	587	1014	1	60	30	49	1.60
BWS3066NFL	361	448	612	1092	1	66	30	54	1.76
BWS3072NFL	381	476	648	1176	1	72	30	59	1.91
BWS3078NFL	404	504	686	1297	1	78	30	64	2.10
BWS3084NFL	446	557	751	1398	1	84	30	69	2.24
BWS3672NFL	724	944	1118	1443	1	72	36	71	2.30

**BWSC • Curvelinair Front Edge Worksurface**

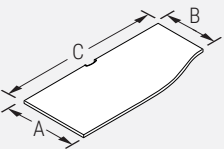

- Curvelinair front edge worksurface.
- Allows efficient use of a small footprint.
- The curve on the 30" and 36" wide worksurfaces have been modified to allow a pedestal to fit.
- Please choose from DWT - Designer White, SIL- Silver or BLK - Black for scoop covers.
- Surfaces 60" wide will have two scoops, all other have one scoop.

**NOTE: BWSC**

24	18	30
A	B	C
WIDTH	WIDTH	LENGTH

PRODUCT CODE	PRICE LP*	GROUP			SIZE/INCHES			WEIGHT VOL	
		HP*	T*	W*	H	W	D	LBS	FT <sup>3</sup>
BWSC182430P	179	222	355	711	1	30	24	18	0.65
BWSC182436P	215	271	404	898	1	36	24	22	0.78
BWSC182442P	252	314	458	898	1	42	24	26	0.90
BWSC182448P	287	361	508	970	1	48	24	30	1.03
BWSC182454P	323	405	561	1035	1	54	24	34	1.20
BWSC182460P	361	448	617	1081	1	60	24	38	1.30
BWSC241830P	179	222	355	711	1	30	24	18	0.65
BWSC241836P	215	271	404	789	1	36	24	22	0.78
BWSC241842P	252	314	458	898	1	42	24	26	0.90
BWSC241848P	287	361	508	970	1	48	24	30	1.03
BWSC241854P	323	405	561	1035	1	54	24	34	1.2
BWSC241860P	361	448	617	1081	1	60	24	38	1.3
BWSC243030P	188	236	367	802	1	30	30	23	0.81
BWSC243036P	215	271	408	868	1	36	30	28	1
BWSC243042P	311	385	540	1010	1	42	30	33	1.13
BWSC243048P	323	405	572	1081	1	48	30	38	1.3
BWSC243054P	361	447	626	1181	1	54	30	42	1.44
BWSC243060P	393	495	681	1227	1	60	30	47	1.6
BWSC302430P	188	236	367	802	1	30	30	23	0.81
BWSC302436P	215	271	408	868	1	36	30	28	1
BWSC302442P	311	385	540	1010	1	42	30	33	1.13
BWSC302448P	323	405	572	1081	1	48	30	38	1.3
BWSC302454P	361	447	626	1181	1	54	30	42	1.44
BWSC302460P	393	491	681	1226	1	60	30	47	1.6

LP = Thermally Fused Laminate, HP = High Pressure Laminate, T= High Pressure Laminate with Wood Trim, W= Wood Veneer



**BWCC • Curved-Corner Worksurface**

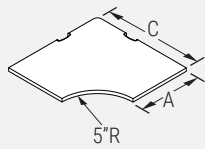

- Allows efficient use of corner space for computer or printer applications.
- BWCC3624 has a front radius of 12". It is not usable for keyboard support.
- Please choose from DWT - Designer White, SIL - Silver or BLK - Black for scoop covers.

**NOTE: BWCC**

36	18
C	A
WIDTH	DEPTH

PRODUCT CODE	PRICE LP*	GROUP HP*	T*	W*	SIZE/INCHES			WEIGHT VOL	
BWCC3618P	352	439	622	1198	1	36	36	29	1.20
BWCC3624P	387	484	792	1335	1	36	36	32	1.20
BWCC4224P	525	657	856	1407	1	42	42	41	1.60
BWCC4230P	538	671	853	1448	1	42	42	45	1.60
BWCC4824P	612	765	1019	1885	1	48	48	50	2.00
BWCC4830P	612	765	1019	1885	1	48	48	56	2.00

PRODUCT CODE	RADIUS "R"
BWCC3618P	18"
BWCC3624P	12"
BWCC4224P	18"
BWCC4230P	12"
BWCC4824P	24"
BWCC4830P	18"

NOTE: 12" radius not recommended for keyboards

**BWCF • Five-Sided Corner Worksurface**

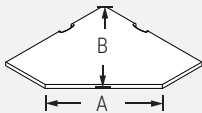

- Creates efficient use of corner space for computer or printer applications.
- Please choose from DWT - Designer White, SIL - Silver or BLK - Black for scoop covers.

PRODUCT CODE	PRICE LP*	GROUP HP*	T*	W*	SIZE/INCHES			WEIGHT VOL	
BWCF3012P	218	272	405	1045	1	30	30	28	1.00
BWCF3612P	303	378	487	1069	1	36	36	30	1.03
BWCF3618P	303	378	487	1069	1	36	36	31	1.20
BWCF3624P	318	395	504	1069	1	36	36	33	1.20
BWCF3630P	333	414	522	1069	1	36	36	35	1.20
BWCF4218P	433	540	664	1273	1	42	42	40	1.60
BWCF4224P	446	557	684	1273	1	42	42	45	1.60
BWCF4230P	462	576	702	1273	1	42	42	47	1.60
BWCF4818P	490	612	775	1474	1	48	48	40	1.60
BWCF4824P	506	628	790	1474	1	48	48	45	1.60
BWCF4830P	534	664	829	1474	1	48	48	47	1.60

PRODUCT CODE	PANEL SIZES	ADJOINED WORKSURFACE DEPTH	A	B
BWCF3012P	30	12	25.5	29.8
BWCF3612P	36	12	34.0	34.0
BWCF3618P	36	18	25.5	37.9
BWCF3624P	36	24	17.0	42.1
BWCF3630P	36	30	8.5	46.4
BWCF4218P	42	18	33.9	42.1
BWCF4224P	42	24	25.5	46.4
BWCF4230P	42	30	17.0	50.6
BWCF4818P	48	18	42.4	46.4
BWCF4824P	48	24	33.9	50.6
BWCF4830P	48	30	25.5	54.8

**BWCL • "L" Corner Worksurface**

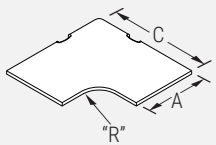

- Creates efficient use of corner space for computer or printer applications.
- Please choose from DWT - Designer White, SIL - Silver or BLK - Black for scoop covers.

**NOTE: BWCL**

5" radius not recommended for keyboards.

36	18
C	A
WIDTH	DEPTH

PRODUCT CODE	PRICE LP*	GROUP HP*	T*	W*	SIZE/INCHES			WEIGHT VOL	
BWCL3018P	218	270	372	1191	1	30	30	20	0.80
BWCL3024P	215	271	367	1191	1	30	30	23	0.80
BWCL3618P	318	395	508	1198	1	36	36	27	1.20
BWCL3624P	333	414	525	1198	1	36	36	31	1.20
BWCL3630P	345	433	544	1198	1	36	36	34	1.20
BWCL4218P	462	576	702	1407	1	42	42	32	1.60
BWCL4224P	476	594	719	1407	1	42	42	39	1.60
BWCL4230P	490	612	739	1407	1	42	42	44	1.60
BWCL4818P	504	628	790	1608	1	48	48	38	2.00
BWCL4824P	518	647	810	1608	1	48	48	47	2.00
BWCL4830P	531	664	829	1608	1	48	48	54	2.00

LP = Thermally Fused Laminate, HP = High Pressure Laminate, T= High Pressure Laminate with Wood Trim, W= Wood Veneer

**BWAC45 • Curved-Corner Worksurface for 45 Degree Angle**

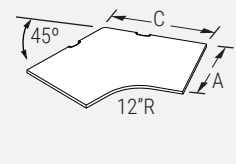

- Five-sided corner unit for 45 degree Corner Posts.
- Creates efficient use of space for computer or printer application.
- Please choose from DWT - Designer White, SIL - Silver or BLK - Black for scoop covers.

**NOTE: BWAC**

45°	24	18
	C	A
45° POST	WIDTH	DEPTH

PRODUCT CODE	PRICE LP*	GROUP HP*	T*	W*	SIZE/INCHES			WEIGHT VOL	
					H	W	D	LBS	FT <sup>3</sup>
BWAC452418P	352	439	628	1133	1	24	18	38	1.14
BWAC452424P	367	460	775	1398	1	24	24	42	1.29
BWAC452430P	382	476	992	1797	1	24	30	48	1.45
BWAC453018P	452	566	1356	1812	1	30	18	53	1.61
BWAC453024P	513	641	1618	2157	1	30	24	60	1.80
BWAC453030P	567	711	2067	2753	1	30	30	66	2.01
BWAC453618P	636	793	1578	2096	1	36	18	66	2.01
BWAC453624P	706	884	1942	2586	1	36	24	71	2.16
BWAC453630P	778	970	2444	3254	1	36	30	76	2.30

**BWAC60 • Curved-Corner Worksurface for 60 Degree Angle**

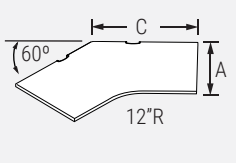

- Five-sided corner unit for 60 degree Corner Posts.
- Creates efficient use of space for computer or printer application.
- Please choose from DWT - Designer White, SIL - Silver or BLK - Black for scoop covers.

**NOTE: BWAC**

60°	24	18
	C	A
60° POST	WIDTH	DEPTH

PRODUCT CODE	PRICE LP*	GROUP HP*	T*	W*	SIZE/INCHES			WEIGHT VOL	
					H	W	D	LBS	FT <sup>3</sup>
BWAC602418P	303	378	504	905	1	24	18	33	0.99
BWAC602424P	318	395	628	1133	1	24	24	36	1.09
BWAC602430P	333	414	684	1227	1	24	30	39	1.19
BWAC603018P	411	516	1143	1520	1	30	18	48	1.46
BWAC603024P	447	561	1344	1793	1	30	24	52	1.58
BWAC603030P	481	601	1462	1947	1	30	30	56	1.71
BWAC603618P	588	734	1334	1767	1	36	18	66	2.01
BWAC603624P	632	789	1572	2096	1	36	24	71	2.16
BWAC603630P	678	843	1716	2285	1	36	30	76	2.31

**BWCE • Extended Curved-Corner Worksurface**

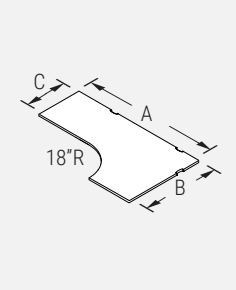

- Extended curved-corner unit with a radius user edge.
- Creates efficient use of a corner unit.
- Please choose from DWT - Designer White, SIL - Silver or BLK - Black for scoop covers.

**NOTE: BWCE**

60	42	24
A	B	C
WIDTH	WIDTH	LENGTH

PRODUCT CODE	PRICE LP*	GROUP HP*	T*	W*	SIZE/INCHES			WEIGHT VOL	
					H	W	D	LBS	FT <sup>3</sup>
BWCE426024P	628	788	1198	1970	1	60	42	57	2.2
BWCE426624P	693	867	1286	2056	1	66	42	62	2.5
BWCE427224P	767	1010	1414	2312	1	72	42	66	2.7
BWCE427824P	819	1025	1500	2486	1	78	42	71	2.9
BWCE428424P	883	1103	1626	2655	1	84	42	75	3.1
BWCE486024P	719	900	1500	2486	1	60	48	66	2.5
BWCE486624P	790	992	1587	2569	1	66	48	71	2.8
BWCE487224P	863	1079	1626	2655	1	72	48	76	3.1
BWCE487824P	937	1171	1755	2913	1	78	48	83	3.3
BWCE488424P	1008	1259	1885	3082	1	84	48	93	3.6
BWCE486030P	790	992	1626	2655	1	60	48	68	2.5
BWCE486630P	863	1079	1712	2784	1	66	48	74	2.8
BWCE487230P	937	1171	1755	2870	1	72	48	80	3.1
BWCE487830P	1008	1259	1885	3040	1	78	48	85	3.3
BWCE488430P	1062	1331	1970	3169	1	84	48	96	3.6
BWCE604224P	628	788	1198	1970	1	42	60	57	2.2
BWCE604824P	693	900	1500	2486	1	48	60	66	2.6
BWCE604830P	767	992	1626	2655	1	48	60	68	2.6
BWCE664224P	819	867	1286	2056	1	42	66	62	2.5
BWCE664824P	883	992	1587	2569	1	48	66	71	2.8
BWCE664830P	719	1079	1712	2784	1	48	66	74	2.8
BWCE724224P	790	1010	1414	2312	1	42	72	66	2.7
BWCE724824P	863	1079	1626	2655	1	48	72	76	3.1
BWCE724830P	937	1171	1755	2870	1	48	72	80	3.1
BWCE784224P	1008	1025	1500	2486	1	42	78	71	2.9
BWCE784824P	790	1171	1755	2913	1	48	78	83	3.3
BWCE784830P	863	1259	1885	3040	1	48	78	85	3.3
BWCE844224P	937	1103	1626	2655	1	42	84	75	3.1
BWCE844824P	1008	1259	1885	3082	1	48	84	93	3.6
BWCE844830P	1062	1331	1970	3169	1	48	84	96	3.6

LP = Thermally Fused Laminate, HP = High Pressure Laminate, T= High Pressure Laminate with Wood Trim, W= Wood Veneer

**BWCEC • Extended Curvilinear Corner Worksurface**

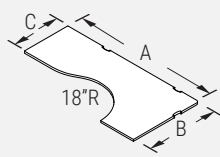

- Extended curved-corner unit with a radius user edge.
- Creates efficient use of a corner unit.
- Please choose from DWT - Designer White, SIL - Silver or BLK - Black for scoop covers.

NOTE: BWSC

66	42	24
A	B	C
WIDTH	WIDTH	LENGTH

PRODUCT CODE	PRICE LP*	GROUP HP*	T*	W*	SIZE/INCHES			WEIGHT VOL	
					A	B	C	LBS	FT <sup>3</sup>
BWCEC366024P	572	714	1024	1704	36	60	24	59	0.05
BWCEC366624P	600	750	1129	1873	36	66	24	65	0.60
BWCEC367224P	655	819	1227	2046	36	72	24	71	0.07
BWCEC367824P	709	889	1334	2217	36	78	24	77	0.07
BWCEC368424P	790	989	1432	2386	36	84	24	83	0.08
BWCEC426624P	691	862	1277	2046	42	66	24	76	0.07
BWCEC427224P	763	955	1405	2303	42	72	24	83	0.08
BWCEC427824P	816	1019	1491	2476	42	78	24	90	0.08
BWCEC428424P	876	1099	1620	2645	42	84	24	96	0.09
BWCEC487230P	932	1164	1747	2857	48	72	30	94	0.09
BWCEC487830P	1004	1256	1873	3028	48	78	30	102	0.09
BWCEC488424P	876	1099	1620	2645	48	84	24	110	0.10
BWCEC488430P	1057	1321	1963	3154	48	84	30	110	0.10
BWCEC603624P	572	714	1024	1704	60	36	24	59	0.05
BWCEC663624P	600	750	1129	1873	66	36	24	65	0.60
BWCEC664224P	691	862	1277	2046	66	42	24	76	0.07
BWCEC723624P	655	819	1227	2046	72	36	24	71	0.07
BWCEC724224P	763	955	1405	2303	72	42	24	83	0.08
BWCEC724830P	932	1164	1747	2857	72	48	30	94	0.09
BWCEC783624P	709	889	1334	2217	78	36	24	77	0.07
BWCEC784224P	816	1019	1491	2476	78	42	24	89	0.08
BWCEC784830P	1004	1256	1873	3028	78	48	30	102	0.09
BWCEC843624P	790	989	1432	2386	84	36	24	83	0.08
BWCEC844224P	790	989	1432	2386	84	42	24	96	0.09
BWCEC844824P	876	1099	1620	2645	84	48	24	110	0.10
BWCEC844830P	1057	1321	1963	3154	84	48	30	110	0.10

**BWSL • Curvilinear Arc Worksurface**

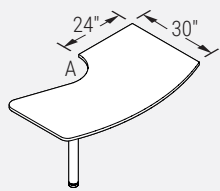

RIGHT HAND SHOWN  
MONOLEG MOUNTED ON  
THE RIGHT USER SIDE.

- Arc shaped worksurface provides an extended conferencing area.
- 1 BHML03 Monoleg included.
- Not recommended for use with modesty panel due to knee swing interference.
- For chrome finish on leg, please add \$107 list upcharge.

PRODUCT CODE	PRICE LP*	GROUP HP*	T*	W*	SIZE/INCHES			WEIGHT VOL	
					H	W	D	LBS	FT <sup>3</sup>
BWSL3060L	754	943	1099	1934	29	60	30	48	1.69
BWSL3066L	790	992	1223	2159	29	66	30	53	1.85
BWSL3072L	824	1035	1348	2427	29	72	30	58	2.01
BWSL3060R	754	943	1099	1934	29	60	30	48	1.69
BWSL3066R	790	992	1223	2159	29	66	30	53	1.85
BWSL3072R	824	1035	1348	2427	29	72	30	58	2.01

A = 27" for 60", 66" worksurfaces  
A = 26.5" for 72" worksurfaces

**BWSL • Curveliniar Arc Worksurface**

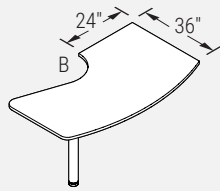

RIGHT HAND SHOWN  
MONOLEG MOUNTED ON  
THE RIGHT USER SIDE.

- Arc shaped worksurface provides an extended conferencing area.
- 1 BHML03 Monoleg included.
- For chrome finish on leg, please add \$107 list upcharge.

PRODUCT CODE	PRICE LP*	GROUP HP*	T*	W*	SIZE/INCHES			WEIGHT VOL	
					H	W	D	LBS	FT <sup>3</sup>
BWSL3660L	859	1079	1259	2203	29	60	36	57	2.07
BWSL3666L	916	1171	1403	2476	29	66	36	64	2.26
BWSL3672L	1003	1259	1549	2741	29	72	36	71	2.45
BWSL3660R	859	1079	1259	2203	29	60	36	57	2.07
BWSL3666R	916	1171	1403	2476	29	66	36	64	2.26
BWSL3672R	1003	1259	1549	2741	29	72	36	71	2.45

B = 33" for 60", 66" worksurfaces  
B = 32.5" for 72" worksurfaces

LP = Thermally Fused Laminate, HP = High Pressure Laminate, T= High Pressure Laminate with Wood Trim, W= Wood Veneer

**BWD • “D” Worksurface**

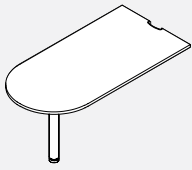

- Rounded worksurface for conferencing.
- Supported by Monoleg at one end and panel at the opposite end.
- 1 BHML03 Monoleg included.
- Modesty panel available, see BWMP (not included).
- For chrome finish on leg, please add \$107 list upcharge.

PRODUCT CODE	PRICE LP*	GROUP HP*	T*	W*	SIZE/INCHES			WEIGHT VOL	
					H	W	D	LBS	FT <sup>3</sup>
BWD2442P	492	619	815	925	1	42	24	27	0.97
BWD2448P	518	647	824	943	1	48	24	31	1.11
BWD2454P	534	664	856	1162	1	54	24	35	1.24
BWD2460P	544	680	876	1391	1	60	24	39	1.36
BWD2466P	557	702	902	1439	1	66	24	43	1.52
BWD2472P	583	728	941	1577	1	72	24	47	1.66
BWD3048P	518	652	858	1500	1	48	30	38	1.38
BWD3054P	546	685	900	1522	1	54	30	43	1.56
BWD3060P	584	729	941	1545	1	60	30	48	1.69
BWD3066P	612	765	986	1630	1	66	30	53	1.82
BWD3072P	646	806	1052	1720	1	72	30	58	2.01
BWD3078P	682	858	1092	2056	1	78	30	63	2.25
BWD3084P	745	935	1198	2229	1	84	30	68	2.42

**BWP • “P” Worksurface**

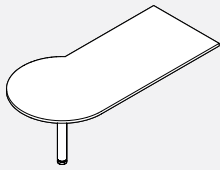

LEFT HAND SHOWN

- Rounded worksurface provides an extended conferencing area.
- 36" diameter end.
- Supported by monoleg at one end and panel at the opposite end.
- 1 BHML03 Monoleg included.
- Modesty panel available, see BWMP (not included).
- For chrome finish on leg, please add \$107 list upcharge.

PRODUCT CODE	PRICE LP*	GROUP HP*	T*	W*	SIZE/INCHES			WEIGHT VOL	
					H	W	D	LBS	FT <sup>3</sup>
BWPL3054	741	924	1155	1836	1	54	36	51	1.87
BWPL3060	775	968	1196	2132	1	60	36	58	2.03
BWPL3066	840	1054	1297	2427	1	66	36	65	2.24
BWPL3072	875	1102	1365	2727	1	72	36	70	2.41
BWPL3084	1133	1223	1515	3251	1	84	36	81	2.79
BWPR3054	741	924	1155	1836	1	54	36	51	1.87
BWPR3060	775	968	1196	2132	1	60	36	58	2.03
BWPR3066	840	1054	1297	2427	1	66	36	65	2.24
BWPR3072	875	1102	1365	2727	1	72	36	70	2.41
BWPR3084	973	1223	1515	3251	1	84	36	81	2.79

**BWMP • “D” and “P” Worksurface Modesty Panel**

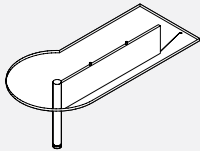

- Made of cold rolled steel, fastens to the worksurface and Monoleg for additional privacy.

PRODUCT CODE	PRICE	SIZE/INCHES			WEIGHT VOL	
		H	W	D	LBS	FT <sup>3</sup>
BWMP1248	120	1	32	12	12	0.4
BWMP1254	145	1	38	12	15	0.47
BWMP1260	168	1	44	12	17	0.53
BWMP1266	195	1	50	12	20	0.61
BWMP1272	217	1	56	12	22	0.66
BWMP1278	234	1	62	12	25	0.71
BWMP1284	250	1	68	12	27	0.79

**BWR • Radius Worksurface**

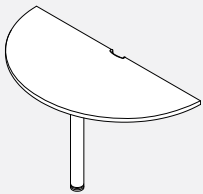

- Rounded worksurface for conferencing provides a radius corner.
- 18" and 24" come with 1 BHML03 Monoleg and 30" comes with 2.
- Radius cut out on the straight edge allows space for aluminum trims.
- For chrome finish on leg, please add \$107 list upcharge for each leg.

PRODUCT CODE	PRICE LP*	GROUP HP*	T*	W*	SIZE/INCHES			WEIGHT VOL	
					H	W	D	LBS	FT <sup>3</sup>
BWR18P	431	540	670	1033	1	38.5	18	27	1.70
BWR24P	498	625	794	1258	1	50.5	24	41	2.20
BWR30P	903	1129	1339	1836	1	62.5	30	59	2.70

**BWRTD • Teardrop Worksurface**

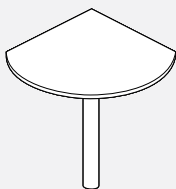

- Rounded worksurface for conferencing provides a radius corner from a worksurface to worksurface.
- 1 BHML03 Monoleg included.
- For chrome finish on leg, please add \$107 list upcharge.

PRODUCT CODE	PRICE LP*	GROUP HP*	T*	W*	SIZE/INCHES			WEIGHT VOL	
					H	W	D	LBS	FT <sup>3</sup>
BWRTD18	260	284	355	446	1	18	18	24	1.60
BWRTD24	328	367	496	660	1	24	24	33	1.90
BWRTD30	417	479	685	945	1	30	30	43	2.20

LP = Thermally Fused Laminate, HP = High Pressure Laminate, T= High Pressure Laminate with Wood Trim, W= Wood Veneer

**BWRP • Corner Radius Worksurface With Cutout**

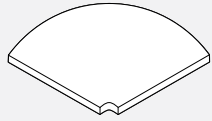

- Corner Radius Worksurface with Cut-Out allows worksurface to be used around a post.
- Cut out fits snug to the post, if trim is attached to the post, the worksurface or PVC trim may need to be cut on site to fit.

PRODUCT CODE	PRICE LP*	GROUP			SIZE/INCHES			WEIGHT VOL	
		HP*	T*	W*	H	W	D	LBS	FT <sup>3</sup>
BWRP1818	153	188	475	639	1	21	21	12	0.40
BWRP2424	218	275	489	665	1	27	27	19	0.64
BWRP3030	270	339	608	840	1	33	33	29	1.00

**BWT • Transaction Worksurface**

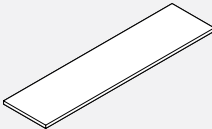

- Attaches to the top of a 37" or 42" high panel to form a transaction worksurface.
- To attach a Boulevard 1 37" high panel please specify BHBT37, all other heights specify BHBT02.
- To attach a Boulevard 1 panel with flat trim, please specify BHBT37FT or BHBT02FT.

PRODUCT CODE	PRICE LP*	GROUP			SIZE/INCHES			WEIGHT VOL	
		HP*	T*	W*	H	W	D	LBS	FT <sup>3</sup>
BWT1512	64	72	141	214	1	12	15	5	0.22
BWT1518	75	95	179	242	1	18	15	7	0.30
BWT1524	95	115	215	323	1	24	15	10	0.38
BWT1530	112	136	252	382	1	30	15	12	0.46
BWT1536	126	158	287	419	1	36	15	14	0.54
BWT1542	146	179	328	480	1	42	15	17	0.62
BWT1548	161	203	365	522	1	48	15	19	0.70
BWT1554	178	221	401	545	1	54	15	22	0.78
BWT1560	198	247	436	571	1	60	15	24	0.86
BWT1566	212	266	475	626	1	66	15	28	0.94
BWT1572	230	287	511	786	1	72	15	29	1.02
BWT1578	249	311	550	870	1	78	15	31	1.10
BWT1584	266	331	594	965	1	84	15	34	1.18

**BWTC • Transaction Corner Worksurface**

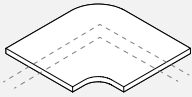

- Attaches to the top of a 37" or 42" high panel to form a corner transaction worksurface.
- Covers 12" of a panel.
- To attach a 37" high panel please specify BHBT37, all other heights specify BHBT02.
- To attach a Boulevard 1 panel with flat trim, please specify BHBT37FT or BHBT02FT.

PRODUCT CODE	PRICE LP*	GROUP			SIZE/INCHES			WEIGHT VOL	
		HP*	T*	W*	H	W	D	LBS	FT <sup>3</sup>
BWTC90	144	176	285	637	1	20.7	20.7	11	0.49
BWTC45	173	215	334	660	1	21.5	21.5	12	0.53
BWTC60	172	215	334	660	1	22.5	22.5	14	0.60

**BWTT • Transaction "T" Worksurface**

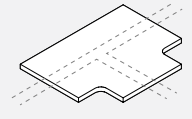

- Attaches to the top of a 37" or 42" high panel to form a "T" corner transaction worksurface
- Covers 12" of a panel.
- To attach a 37" high panel please specify BHBT37, all other heights specify BHBT02.

PRODUCT CODE	PRICE LP*	GROUP			SIZE/INCHES			WEIGHT VOL	
		HP*	T*	W*	H	W	D	LBS	FT <sup>3</sup>
BWTT2721	151	188	312	660	1	21.5	26.5	15	0.6

**BWTAC • Transaction Worksurface for 45 Degree Corner Worksurface**

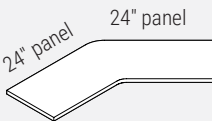

- Attaches to the top of 37" or 42" high panel to form a 45 degree corner transaction worksurface.
- To attach a 37" high panel please specify BHBT37, all other heights specify BHBT02.

PRODUCT CODE	PRICE LP*	GROUP			SIZE/INCHES			WEIGHT VOL	
		HP*	T*	W*	H	W	D	LBS	FT <sup>3</sup>
BWTAC452415	628	788	822	1155	1	47	15	39	1.38

**BWTAC • Transaction Worksurface for 60 Degree Corner Worksurface**



- Attaches to the top of 42" high panel to form a 60 degree corner transaction worksurface.
- To attach a 37" high panel please specify BHBT37, all other heights specify BHBT02.

PRODUCT CODE	PRICE LP*	GROUP			SIZE/INCHES			WEIGHT VOL	
		HP*	T*	W*	H	W	D	LBS	FT <sup>3</sup>
BWTAC602415	680	854	900	1188	1	44	15	38	1.32

LP = Thermally Fused Laminate, HP = High Pressure Laminate, T= High Pressure Laminate with Wood Trim, W= Wood Veneer

**BWTD • Transaction “D” Worksurface**

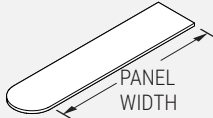

- Attaches to the top of a 37" or 42" high panel to form a transaction worksurface with a radiused end.
- Surface overhangs the panel by 7 1/2" on one side.
- To attach a 37" high panel please specify BHBT37, all other heights specify BHBT02.

PRODUCT CODE	PRICE LP*	GROUP			SIZE/INCHES			WEIGHT VOL	
		HP*	T*	W*	H	W	D	LBS	FT <sup>3</sup>
BWTD1530	144	176	328	534	1	37.5	15	17	0.65
BWTD1536	155	190	345	566	1	43.5	15	19	0.69
BWTD1542	172	212	378	608	1	49.5	15	22	0.74
BWTD1548	188	236	414	665	1	55.5	15	25	0.77
BWTD1554	204	254	448	691	1	61.5	15	27	0.85
BWTD1560	226	281	492	714	1	67.5	15	30	0.94
BWTD1566	242	302	529	817	1	73.5	15	33	1.02
BWTD1572	266	328	567	913	1	79.5	15	35	1.10

**BWTD • Transaction Double “D” Worksurface**

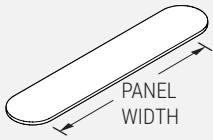

- Attaches to the top of a 37" or 42" high panel to form a transaction worksurface with 2 radius ends.
- Surface overhangs the panel by 7 1/2" on each end.
- To attach a 37" high panel please specify BHBT37, all other heights specify BHBT02.

PRODUCT CODE	PRICE LP*	GROUP			SIZE/INCHES			WEIGHT VOL	
		HP*	T*	W*	H	W	D	LBS	FT <sup>3</sup>
BWTD1548	211	266	490	817	1	63	15	28	1.00
BWTD1554	228	287	536	860	1	69	15	31	1.01
BWTD1560	248	311	565	884	1	75	15	33	1.04
BWTD1566	266	334	604	1013	1	81	15	35	1.13
BWTD1572	287	361	642	1135	1	87	15	38	1.21

**BWTE • Elliptical Transaction Worksurface**

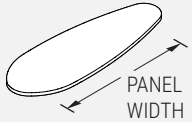

- Attaches to the top of a 37" or 42" high panel to form a transaction worksurface.
- To attach a 37" high panel please specify BHBT37, all other heights specify BHBT02.
- Depth different than standard tops.

PRODUCT CODE	PRICE LP*	GROUP			SIZE/INCHES			WEIGHT VOL	
		HP*	T*	W*	H	W	D	LBS	FT <sup>3</sup>
BWTE36	302	378	971	1398	1	52	18	22	0.78
BWTE42	345	433	1079	1512	1	58	19	24	0.81

**BWTP • Oval Transaction Worksurface**



- Attaches to the top of a 37" or 42" high panel to form a transaction worksurface.
- To attach a 37" high panel please specify BHBT37, all other heights specify BHBT02.
- Must be specified at post condition or panel joint.

PRODUCT CODE	PRICE LP*	GROUP			SIZE/INCHES			WEIGHT VOL	
		HP*	T*	W*	H	W	D	LBS	FT <sup>3</sup>
BWTP1518	216	271	439	693	1	15	18	10	0.35

**BWCD • Round Table**



- Freestanding round meeting table with 4-prong tubular base.

PRODUCT CODE	PRICE LP*	GROUP			SIZE/INCHES			WEIGHT VOL	
		HP*	T*	W*	H	W	D	LBS	FT <sup>3</sup>
BWCD30	448	495	829	1078	29	30 dia	30 dia	35	10.0
BWCD36	463	572	992	1235	29	36 dia	36 dia	42	10.0
BWCD42	574	718	1223	1661	29	42 dia	42 dia	52	11.0

**BWSQ • Square Table**

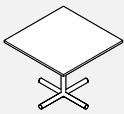

- Freestanding square meeting table with 4-prong tubular base.

PRODUCT CODE	PRICE LP*	GROUP			SIZE/INCHES			WEIGHT VOL	
		HP*	T*	W*	H	W	D	LBS	FT <sup>3</sup>
BWSQ24	450	473	702	986	29	24	24	34	10.0
BWSQ30	448	495	829	1078	29	30	30	38	10.0
BWSQ36	459	572	1005	1235	29	36	36	46	11.0
BWSQ42	659	718	1223	1661	29	42	42	57	11.0

LP = Thermally Fused Laminate, HP = High Pressure Laminate, T= High Pressure Laminate with Wood Trim, W= Wood Veneer

**BHCL • "C" Leg**

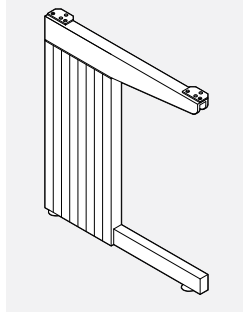

- Attaches to panel support worksurface or to provide freestanding table support.
- Steel structure, PVC cover.
- Universal non-handed.
- For a single rectangular freestanding worksurface application, specify two "C" legs and one modesty panel of corresponding width.
- May be used as a shared leg between two adjoining worksurfaces. Specify one "C" leg, one modesty panel of corresponding width, plus one modesty panel extension bracket.
- For corner worksurfaces, specify two "C" legs, one corner leg and two modesty panels 6" shorter than rear sides of the corner worksurface.
- Can be used as a floor support in a panel-attached application (similar to a cantilever).
- Includes worksurface mounting brackets with screws, bracket retainer clip and panel bracket.
- Accommodates 15" knee space.

PRODUCT CODE	PRICE	SIZE/INCHES			WEIGHT VOL	
		H	W	D	LBS	FT <sup>3</sup>
BHCL2618	211	25	1	18	7	0.27
BHCL2624	218	25	1	24	8	0.36
BHCL2918	227	28	1	18	8	0.30
BHCL2924	238	28	1	24	9	0.40

**BKC • Corner Leg**

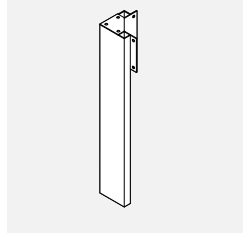

- Five-sided worksurface support.
- Steel construction.
- Non handed.
- Includes bolts for modesty panel attachment.
- For corner worksurfaces, specify two "C" legs, one corner leg and two modesty panels 6" shorter than rear sides of the corner worksurface.

PRODUCT CODE	PRICE	SIZE/INCHES			WEIGHT VOL	
		H	W	D	LBS	FT <sup>3</sup>
BKC26	126	25	7	7	3.0	0.02
BKC29	145	28	7	7	3.2	0.02

**BKMP • Modesty Panel**

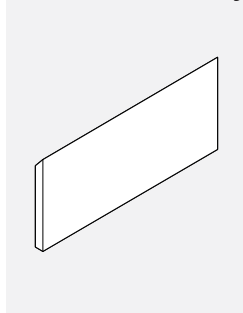

- For rectangular worksurfaces, specify modesty panel of corresponding width. For corner worksurfaces, specify two modesty panels 6" shorter than rear side of corner worksurface.
- Attaches between two "C" legs, or between one "C" leg and a corner leg, or a shared "C" leg and "C" leg at the end of a run.
- Includes brackets and screws to attach modesty panel to worksurface.

PRODUCT CODE	PRICE	SIZE/INCHES			WEIGHT VOL	
		H	W	D	LBS	FT <sup>3</sup>
BKMP1224	145	11	24	0.25	2.75	0.17
BKMP1230	153	11	30	0.25	2.75	0.21
BKMP1236	163	11	36	0.25	3.00	0.25
BKMP1242	172	11	42	0.25	4.00	0.29
BKMP1248	179	11	48	0.25	4.50	0.33
BKMP1254	188	11	54	0.25	5.00	0.38
BKMP1260	199	11	60	0.25	5.50	0.42

**BHMEB • Modesty Panel Extension Bracket**

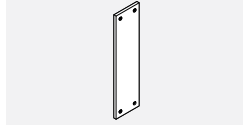

- Modesty panel extension bracket made of cold rolled steel.
- Attaches the modesty panel of an adjoining worksurface to a shared "C" leg.
- Includes all attachment hardware.

PRODUCT CODE	PRICE	SIZE/INCHES			WEIGHT VOL	
		H	W	D	LBS	FT <sup>3</sup>
BHMEB01	23	10	1.5	0.125	0.5	0.01

**BHFG • Full Gable - Self Edged**

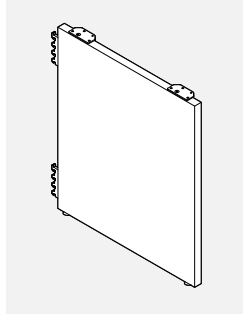

- Provides floor standing support while enclosing an end of a run of worksurfaces.
- Includes attachment hardware, bracket retainer clip and leveling glides.
- Non-handed.
- May be used as a shared gable between two adjoining worksurfaces.

PRODUCT CODE	PRICE LP*	GROUP HP*	SIZE/INCHES			WEIGHT VOL	
			H	W	D	LBS	FT <sup>3</sup>
BHFG2608	130	163	25	1	8	7	0.14
BHFG2612	166	209	25	1	12	13	0.21
BHFG2618	203	253	25	1	18	13	0.27
BHFG2624	222	280	25	1	24	19	0.36
BHFG2630	301	374	25	1	30	23	0.45
BHFG2636	378	473	25	1	36	24	0.57
BHFG2908	130	163	28	1	8	7	0.16
BHFG2912	166	209	28	1	12	14	0.30
BHFG2918	203	253	28	1	18	14	0.30
BHFG2924	222	280	28	1	24	17	0.40
BHFG2930	301	374	28	1	30	21	0.50
BHFG2936	378	473	28	1	36	26	0.65

LP = Thermally Fused Laminate, HP = High Pressure Laminate, T= High Pressure Laminate with Wood Trim, W= Wood Veneer

**BHFGP • Full Gable - 3 mm PVC Edged**

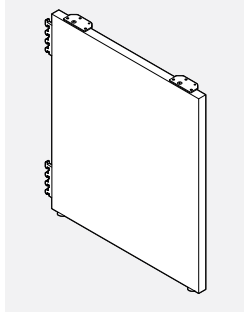

- Provides floor standing support while enclosing an end of a run of worksurfaces.
- Includes attachment hardware, bracket retainer clip and leveling glides.
- Provides consistent edging matching the worksurface trim.
- Handed once installed.
- May be used as a shared gable between two adjoining worksurfaces.

PRODUCT CODE	PRICE LP*	GROUP HP*	SIZE/INCHES			WEIGHT VOL	
			H	W	D	LBS	FT <sup>3</sup>
BHFGP2608	130	163	25	1	8	7	0.14
BHFGP2612	166	209	25	1	12	13	0.21
BHFGP2618	203	253	25	1	18	13	0.27
BHFGP2624	222	280	25	1	24	19	0.36
BHFGP2630	301	374	25	1	30	23	0.45
BHFGP2636	378	473	25	1	36	24	0.57
BHFGP2908	130	163	28	1	8	7	0.16
BHFGP2912	166	209	28	1	12	14	0.30
BHFGP2918	203	253	28	1	18	14	0.30
BHFGP2924	222	280	28	1	24	17	0.40
BHFGP2930	301	374	28	1	30	21	0.50
BHFGP2936	378	473	28	1	36	26	0.65

**BHPG • “P” Shaped Full Gable - 3 mm PVC Edged**

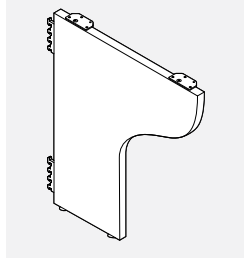

- Provides floor standing support while enclosing an end of a run of worksurfaces.
- Includes attachment hardware, bracket retainer clip and leveling glides.
- Handed due to hardware attachment and PVC edge.

PRODUCT CODE	PRICE LP*	GROUP HP*	SIZE/INCHES			WEIGHT VOL	
			H	W	D	LBS	FT <sup>3</sup>
BHPG2624L	222	280	25	1	24	19	0.36
BHPG2924L	222	280	28	1	24	17	0.40
BHPG2624R	222	280	25	1	24	19	0.36
BHPG2924R	222	280	28	1	24	17	0.40

**BHLEG • Gable Leg**

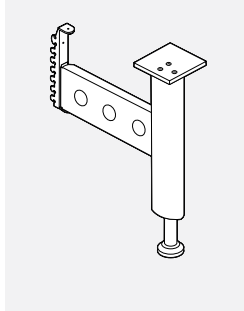

- Supports the worksurface and enhances the stability of connected panels.
- Universal leg plate bolts to the underside of the worksurface.
- Can be configured on-site for left, right or shared worksurface support application on front edge.
- Back edge does not have shared support.
- Tubular leg section adjusts in 1" increments, the leveler can be used for fine adjustment.
- 1" increment leg adjustment and 1" increment panel slots allow the leg of installed worksurface to be supported from 26" to 32". (Leg must be removed from panel to manually adjust.)
- Side plate is secured to the slots in the vertical of the Boulevard 1 or System 3 panels and the leg plate bolts to underside of the worksurface.
- Made of extruded aluminum and steel.
- Includes all mounting hardware to connect to panel and worksurface.

PRODUCT CODE	PRICE	GROUP	SIZE/INCHES			WEIGHT VOL	
			H	W	D	LBS	FT <sup>3</sup>
BHLEG	188		28	6	23	8	0.15

**BRTHLEG • Boulevard Leg Assembly**

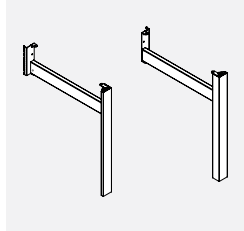

- Boulevard leg assembly attaches to a Boulevard panel for applications which require functionality of Boulevard panels with an open environment.
- One leg with horizontal member connecting to 1" increment slots in panel's vertical frame member. Provides support to panel and panel-connected worksurface at the end of a run; design coordinated with Boulevard freestanding tables.
- Supports 24" and 30" deep worksurfaces. By adding 2 BHBF01 flat brackets and 1 BHBC02 corner bracket, a single leg can then support the adjoining worksurface. Leveling glide is standard. No worksurface-supporting beams, use panel cantilevers and storage for worksurface support. One aluminum leg with steel structure – specify left or right and 24" or 30" deep for corresponding worksurface depths. Panel bracket, dislodgment clip and worksurface hardware included.
- Please specify paint finish for support.

PRODUCT CODE	PRICE	GROUP	SIZE/INCHES			WEIGHT VOL	
			H	W	D	LBS	FT <sup>3</sup>
BRTHLEG24LL	405		28	2.5	24	9	1.25
BRTHLEG24RL	405		28	2.5	24	9	1.25
BRTHLEG30LL	425		28	2.5	30	11	1.45
BRTHLEG30RL	425		28	2.5	30	11	1.45

**BRTBL • Boulevard Leg Assembly**

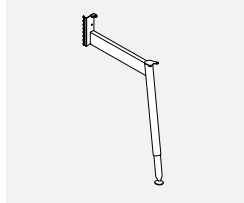

- Boulevard leg assembly attaches to a Boulevard panel for applications which require functionality of Boulevard panels with an open environment.
- Panel bracket secures the leg to the panel in 1" increments, within a 24" to 32" height range.
- Panel mounting bracket is reversible for non-handed applications.
- Supports 24" and 30" deep worksurfaces. By adding 2 BHBF01 flat brackets and 1 BHBC02 corner bracket, a single leg can then support the adjoining worksurface. Leveling glide is standard. No worksurface-supporting beams, use panel cantilevers and storage for worksurface support. Panel bracket, dislodgment clip and worksurface hardware included.
- Leveling glide is standard.

PRODUCT CODE	PRICE	GROUP	SIZE/INCHES			WEIGHT VOL	
			H	W	D	LBS	FT <sup>3</sup>
BRTBL	417		28	3	24	12	1.25

LP = Thermally Fused Laminate, HP = High Pressure Laminate, T= High Pressure Laminate with Wood Trim, W= Wood Veneer



**BHML • Mono Leg**

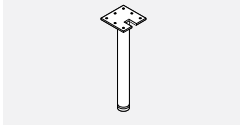

- 3" diameter mono leg provides support for worksurfaces.
- Top plate welded to leg.
- 8" x 8" plated attached to worksurface with #10 3/4" wood screws, included.
- 1" height adjustment range.
- For chrome finish on leg, please add \$107 list upcharge.

PRODUCT CODE	PRICE	SIZE / INCHES			WEIGHT VOL	
		H	W	D	LBS	FT <sup>3</sup>
BHML03	190	28	3	3	8	0.15

**LATBL • Tapered Leg**

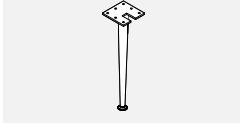

- Tapered leg provides support for worksurfaces.
- Top plate welded to leg.
- 8" x 8" plated attached to worksurface with #10 3/4" wood screws, included.
- 1" height-adjustment range.
- For chrome finish on leg, please add \$107 list upcharge.

PRODUCT CODE	PRICE	SIZE / INCHES			WEIGHT VOL	
		H	W	D	LBS	FT <sup>3</sup>
LATBL28	227	28	3	3	8	0.15

**BHC • Cantilever**

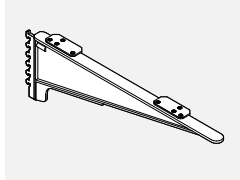

- Universal cantilever with steel attachment bracket constructed of cast aluminum to provide support for worksurfaces.
- Attaches a worksurface to a panel.
- May be used for shared worksurface support.
- Interchangeable in the field for left or right positioning.
- Includes bracket retainer clip.

PRODUCT CODE	PRICE	SIZE / INCHES			WEIGHT VOL	
		H	W	D	LBS	FT <sup>3</sup>
BHC18	77	7	17	2.5	17	0.04
BHC24	77	7	23	2.5	23	0.05

**BHBC • Corner End Bracket**

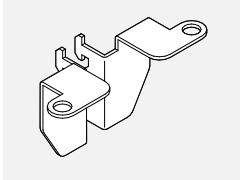

- Formed steel bracket for a corner worksurface or a straight worksurface.
- Attaches a corner of any worksurface to a panel through the panel vertical slots.
- Priced one left and one right per package.
- Includes bracket retainer clip.

PRODUCT CODE	PRICE	SIZE/INCHES			WEIGHT VOL	
		H	W	D	LBS	FT <sup>3</sup>
BHBC02	26	3.3	1.5	2.3	2	0.007

**BHBF • Flat Bracket**

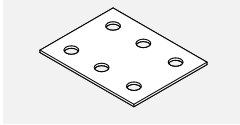

- Flat Bracket made of cold rolled steel.
- May be used to ensure alignment of neighboring worksurfaces.

PRODUCT CODE	PRICE	SIZE/INCHES			WEIGHT VOL	
		H	W	D	LBS	FT <sup>3</sup>
BHBF01	18	0.1	3	4	0.5	0.007

**BHBT • Transaction Bracket**

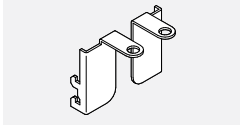

- For use on 34", 42", 50", 58", 66", 74" and 82" high Boulevard panels.
- Transaction bracket made of cold rolled steel.
- To provide a secure attachment of a transaction worksurface.
- Priced one left and one right per package.
- Includes bracket retainer clip.

PRODUCT CODE	PRICE	SIZE/INCHES			WEIGHT VOL	
		H	W	D	LBS	FT <sup>3</sup>
BHBT02	26	3.3	1.5	2.3	2	0.001

**BHBT • Transaction Bracket for 37"-High Boulevard 1 Panel**

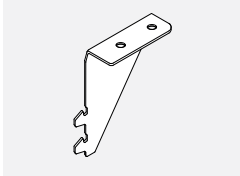

- Transaction Bracket made of cold rolled steel.
- To provide a secure attachment of a transaction worksurface for a 37" high Boulevard 1 panel only. Transaction Bracket engages with the top slots in the 37" high panel to supported for the transaction worksurface.
- Priced one left and one right per package.
- Includes bracket retainer clip.

PRODUCT CODE	PRICE	SIZE/INCHES			WEIGHT VOL	
		H	W	D	LBS	FT <sup>3</sup>
BHBT37	32	4	1	3	0.5	0.007

**BHBZ • "Z" Bracket**

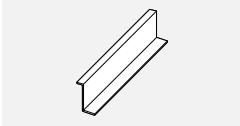

- Attaches two different heights of worksurfaces.
- To be used in conjunction with a cantilever.

PRODUCT CODE	PRICE	SIZE/INCHES			WEIGHT VOL	
		H	W	D	LBS	FT <sup>3</sup>
BHBZ03	75	4	21	4	2	0.190

**FTATB • Boulevard Connector Kit**

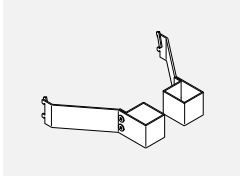

- FreeFit to Boulevard kit secures FreeFit height-adjustable freestanding tables to parallel Boulevard panels.
- It provides panel/table alignment, preventing moving parts from rubbing against panel vertical surfaces and maintains 1" clearance around table surface perimeter.
- Standard metal finishes.
- All hardware included.
- Sold as a pair.

PRODUCT CODE	PRICE	SIZE/INCHES			WEIGHT VOL	
		H	W	D	LBS	FT <sup>3</sup>
FTATB	191	10	6.5	10	7.00	0.50

**LHC • HAT Channel**

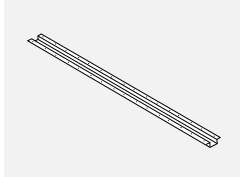

PRODUCT CODE	PRICE	SIZE/INCHES			WEIGHT LBS	VOL FT <sup>3</sup>
		H	W	D		
LHC40	75	1.4	40	5	4	0.20
LHC46	83	1.4	46	5	6	0.22
LHC52	91	1.4	52	5	7	0.25
LHC58	102	1.4	58	5	8	0.28
LHC64	113	1.4	64	5	9	0.31
LHC70	124	1.4	70	5	10	0.33

LP = Thermally Fused Laminate, HP = High Pressure Laminate, T= High Pressure Laminate with Wood Trim, W= Wood Veneer

**TECHNICAL INFORMATION FOR 9300 SERIES PEDESTALS****General Information**

9300 Series Pedestals feature center pull handles (models ending in "C") and full pull handles (models ending in "P"). Freestanding, mobile, and worksurface supporting options available. Quality steel construction. File drawers hold letter or A4 front-to-back and legal side-to-side configurations. Products are finished in a highly durable dry epoxy powder coating and drawer body interiors are finished with 100% recycled paint. Counterweights are included in freestanding and mobile pedestals to meet applicable ANSI/BIFMA X5.9.

**Features**

- Cold rolled steel construction consisting of 16 ga front and back base with 22 ga case.
- Reinforced welded construction.
- Inset drawer fronts and flush base.
- Double-wall construction on all drawer fronts.
- Full extension ball bearing slides on file drawers and ¾ extension on box drawers.
- Rubber bumpers on slides for quietness.
- Worksurface supporting option available (includes mounting holes at top of unit).
- 1 pencil tray and 1 drawer divider are included with each unit containing a box drawer.
- Each file drawer includes a hanging file bar.
- Levelers provide 1" height adjustment.
- Counterweights included for freestanding and mobile pedestals.
- Includes lock with 2 keys.
- Lock is located at the top right of the case above the top drawer.
- Keyed alike option available and can be keyed alike to other storage components.

**Sizes**

- 15" width
  - 19", 23", and 29" depths
- Interior drawer depths:
- 19" Deep pedestals
    - 17 1/4" deep box drawers
    - 16 1/16" deep file drawers
  - 23" deep pedestals
    - 20 3/16" deep box drawers
    - 19 7/16" deep file drawers
  - 29" deep pedestals
    - 26 5/16" deep box drawers
    - 26 1/16" deep file drawers

**Drawer Heights**

Box drawer fronts are 6"H with 5" interior height.  
File drawer fronts are 12"H with 10 9/16" interior height.

**TECHNICAL INFORMATION FOR 9300 SERIES PEDESTALS****General Information**

Prime premium filing and storage products pre-configured to suit your needs; featuring fixed front or receding doors with center pull handles and fully welded seamless tops to deliver strength and clean aesthetics. Premium quality steel construction. File drawers accommodate legal, letter or A4 sizes in back-to-front and side-to-side configurations. Products are finished in a highly durable dry epoxy powder coating and drawer body interiors are finished with 100% recycled paint.

Counterweights are recommended for use in all laterals, pedestals and freestanding files of all widths and heights to meet applicable ANSI/BIFMA X5.9. (Counterweights are offered as an option on all products where required to meet applicable ANSI/BIFMA standard.)

**Features**

- Premium steel construction, 18-22 gauge steel components.
- Full welded and reinforced case construction.
- Interlock system allows only one drawer to open at a time for safety.
- Most products feature full overlay fronts, with some exceptions such as units with receding doors where the front is inset in the case.
- Double wall construction on all drawer and door fronts.
- Full extension roller bearing glides on all drawers.
- Anti-bounce-back safety feature prevents drawers from sliding open.
- Receding doors slide into the cabinet and allow the shelf to be pulled out.
- All pedestals are equipped with four leveling glides, providing 1.5" of height adjustment.
- All other units equipped with four leveling glides providing 1" height adjustment and can be accessed from the interior of the cabinets for ease of adjustment.
- On units with drawers and hinged doors, locks are located at the center of the case above the top opening.
- Lock position on towers with wardrobes is below the handle when center pull is selected.
- Each lock includes 2 keys; locks are standard with removable cores.
- Key assignment is random or can be specified for specific key number for key alike applications.

**Overhead Storage**

- Overhead cabinets: 7 widths in 6" increments.
- 14 5/8" high cases with interior clear height of 12".
- 13" deep units have interior clear dimension of 12.7".
- 16" deep units have interior clear dimension of 15.7".
- Open shelves: 7 widths in 6" increments.
- Shelves are 12 1/2" deep with 7 1/2" high side gables

**Pedestals**

- Freestanding- and worksurface-supporting options available.
- Worksurface-supporting includes mounting holes at top of unit.
- 1 pencil tray and 1 drawer divider are included with each unit containing a box drawer.
- File drawers hold legal, letter or A4 sizes in back-to-front and side-to-side configurations.
- Each file drawer includes a hanging file bar and conversion rails.
- Freestanding units BSPF can be specified with optional non-locking casters to convert to a mobile unit.
- 15" width x 18", 22", and 28" depths.

Interior drawer depth is as follows:

- 15" deep drawers for 18" deep pedestals.
- 19" deep drawers for 22" deep pedestals.
- 25" deep drawers for 28" deep pedestals.

File drawer capacity:

- 14 3/8" filing capacity for file drawers in 18" pedestals.
- 18 3/8" filing capacity for file drawers in 22" pedestals.
- 24 3/8" filing capacity for file drawers in 28" pedestals.

**Laterals**

- 18" depth with interior depth of 16".
- 30", 36", and 42" widths.
- Available in 2 to 6 drawer high (28"H – 77.6"H).

File drawer capacity:

- 30" wide units
  - 26 5/8" in letter and legal side-to-side.
  - 30 1/2" in letter front-to-back .
  - 15 1/4" with 10" side space in legal front-to-back.
- 36" wide units
  - 32 5/8" in letter and legal side-to-side.
  - 30 1/2" with 6 1/2" side space in letter front-to-back.
  - 30 1/2" in legal front-to-back.
- 42" wide units
  - 58 5/8" in letter and legal side-to-side.
  - 45 3/4" in letter front-to-back.
  - 30 1/2" with 6 1/2" side space in legal front-to-back.

## TECHNICAL INFORMATION FOR PRIME SERIES

### Storage Cabinets

- 18" depth.
- 30", 36", and 42" widths.
- Available in 2- to 5-high configurations (28"H – 65.6"H).

### Towers

- Include coat rod and shelf to accommodate personal items.
- The top of the storage compartment is perforated for ventilation.
- Includes locks with 2 keys each.
  - Closed storage comes with 3 locks – one for the drawers, one for the cupboard, and one for the wardrobe.
  - Side open storage comes with 2 locks – one of the drawers and one for the wardrobe.
- 24" depth.
- 24" width.
- 50", 54", and 66" nominal heights available to coordinate with Teknion's panel systems.

## STORAGE COMPONENTS - GUIDELINES FOR ORDERING PRODUCT

### Codes

The price list uses a numbering system with meaningful alphanumeric characters to create a simple-to-understand product number. This makes specifying the product much easier and more accurate.

### How to Specify

- Specify storage pedestal type and size by code, including depth.
- Specify metal color (eg. BLK for Black).
- Specify key random, key list provided, or key number (eg. 401).
- Specify worksurface supporting (1 = Yes, 2 = No).
- Specify counterweight if pedestal is not worksurface supporting (NN = No Counterweight).

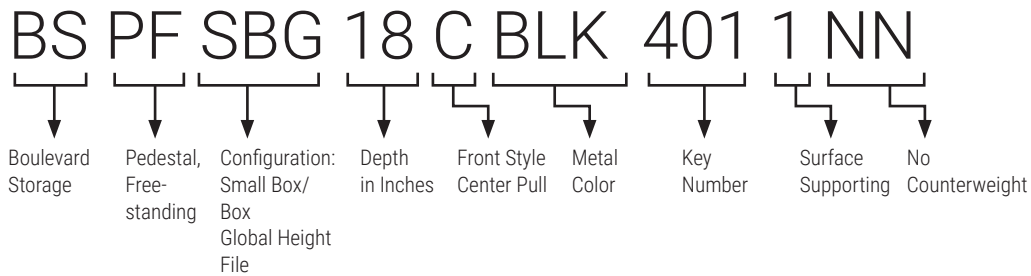

**BSKSS • Panel-Mounted Shelf**

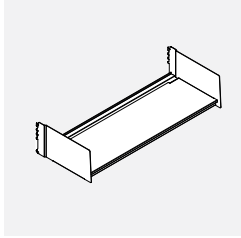

- 14" deep panel-mounted storage shelf with backlip.
- Mounting brackets are included.

PRODUCT CODE	PRICE	SIZE/INCHES			WEIGHT LBS	VOL FT <sup>3</sup>
		H	W	D		
BSKSS24	115	7.45	23.44	14.73	12.8	1.5
BSKSS30	122	7.45	29.44	14.73	14.8	1.9
BSKSS36	134	7.45	35.44	14.73	16.8	2.3
BSKSS42	136	7.45	41.44	14.73	18.8	2.6
BSKSS48	146	7.45	47.44	14.73	20.8	3.0
BSKSS54	155	7.45	53.44	14.73	22.8	3.4
BSKSS60	158	7.45	59.44	14.73	24.8	3.8

**BLSLF • Flush Front Overhead Cabinet**

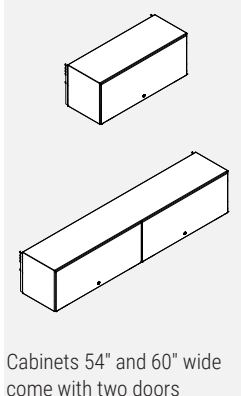

- Flush front overhead cabinet is panel mounted lockable storage unit.
- The door retracts inside/within the overhead cabinet.
- Locks can be keyed alike to match other lockable storage components or keyed random to provide a dedicated lock.
- Available in 13" and 16" depths, 24" to 60" widths at 6" increments.
- Cabinets 54" and 60" wide come with two doors.
- Includes mounting hardware as specified, lock and keys.
- Lock secures into bottom shelf.
- Can be mounted at any height, however 66" high panels are recommended.
- Shipped assembled.

Cabinets 54" and 60" wide come with two doors

PRODUCT CODE	PRICE	SIZE/INCHES			WEIGHT LBS	VOL FT <sup>3</sup>
		H	W	D		
BLSLF1324MN	477	14.62	23.87	13.5	39.3	2.7
BLSLF1330MN	488	14.62	29.87	13.5	44.3	3.4
BLSLF1336MN	541	14.62	35.87	13.5	49.3	4.1
BLSLF1342MN	591	14.62	41.87	13.5	54.3	4.8
BLSLF1348MN	640	14.62	47.87	13.5	59.3	5.5
BLSLF1354MN	686	14.62	53.87	13.5	64.3	6.2
BLSLF1360MN	736	14.62	59.87	13.5	69.3	6.8
BLSLF1624MN	762	14.62	23.87	16.5	38.6	3.4
BLSLF1630MN	785	14.62	29.87	16.5	43.9	4.2
BLSLF1636MN	824	14.62	35.87	16.5	49.2	5.0
BLSLF1642MN	877	14.62	41.87	16.5	54.5	5.8
BLSLF1648MN	935	14.62	47.87	16.5	59.8	6.7
BLSLF1654MN	987	14.62	53.87	16.5	65.1	7.5
BLSLF1660MN	1028	14.62	59.87	16.5	70.4	8.4

**BSADA-PM • Panel-Mounted Overhead Storage Unit - AODA Compliant**

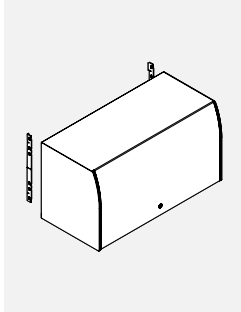

- Panel-mounted metal overhead storage with opaque acrylic door. The mechanism lifts the door up and stores it out of the way, above the storage unit.
- Meets CSA B651 Barrier Free Design and AODA (Accessibility for Ontarians with Disabilities Act).
- 16" high units accept standard and A4 binders.
- All shelves are reinforced for proper weight distribution.
- Inside dimensions: 14.25" high x 13.4" deep.
- Unit includes attachment hardware, lock and mounting brackets.
- Back not included.
- Not recommended for use with wall rails.
- Unit can be converted to up-mount overhead storage unit in the field by adding BSADAxKIT.
- Shipped partially assembled.

PRODUCT CODE	PRICE	SIZE/INCHES			WEIGHT LBS	VOL FT <sup>3</sup>
		H	W	D		
BSADA24PM	955	16	24	14.2	22	4.3
BSADA30PM	1066	16	30	14.2	27	5.3
BSADA36PM	1144	16	36	14.2	32	6.3
BSADA42PM	1227	16	42	14.2	37	7.3
BSADA48PM	1309	16	48	14.2	42	8.3
BSADA54PM	1392	16	54	14.2	47	9.3
BSADA60PM	1471	16	60	14.2	53	10.3

**BSADA-UM • Up-Mounted Overhead Storage Unit - AODA Compliant**

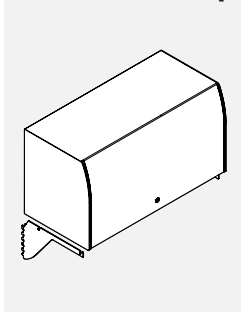

- Up-mounted storage can reduce furniture costs by reducing the height of all panels to 50". Complete 50" panel installations simplify cable routing at one level, within the top lay-in channel. Up-mounted cantilevers maintain accessibility and functionality of the panels' top lay-in channel.
- Meets CSA B651 Barrier Free Design & AODA (Accessibility for Ontarians with Disabilities Act).
- 16" high units accept standard and A4 binders.
- All shelves are reinforced for proper weight distribution.
- Inside dimensions: 14.25" high x 13.4" deep.
- Unit includes attachment hardware, lock, mounting cantilevers and has a finished back.
- Unit can be converted to a panel mounted overhead storage unit in the field by adding BSADAPMxxKIT.
- Shipped partially assembled.

PRODUCT CODE	PRICE	SIZE/INCHES			WEIGHT LBS	VOL FT <sup>3</sup>
		H	W	D		
BSADA24UM	1170	16	24	14.2	25	4.3
BSADA30UM	1264	16	30	14.2	33	5.3
BSADA36UM	1523	16	36	14.2	40	6.3
BSADA42UM	1604	16	42	14.2	46	7.3
BSADA48UM	1691	16	48	14.2	53	8.3
BSADA54UM	1775	16	54	14.2	59	9.3
BSADA60UM	1876	16	60	14.2	66	10.3

**BSADA-KIT • Up-Mounted Conversion Kit**

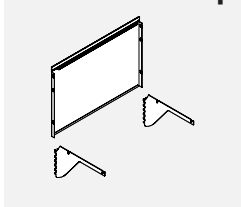

- Converts an existing panel mounted overhead storage unit BSADA-PM to an up-mounted overhead storage unit BSADA-UM.
- When used on a 50" high panel, the top of the overhead will match the height of 66" high panels.
- Kit includes a back panel for the overhead and up-mount cantilevers.

PRODUCT CODE	PRICE	SIZE/INCHES			WEIGHT LBS	VOL FT <sup>3</sup>
		H	W	D		
BSADA24KIT	237	16	24	2	6	0.6
BSADA30KIT	255	16	30	2	8	0.6
BSADA36KIT	268	16	36	2	10	0.7
BSADA42KIT	283	16	42	2	11	0.8
BSADA48KIT	300	16	48	2	13	0.9
BSADA54KIT	312	16	54	2	14	1.0
BSADA60KIT	327	16	60	2	15	1.1

**BSADA-OMKIT • Off-Module Conversion Kit**

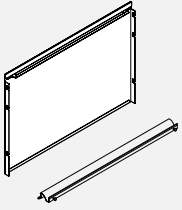

- Converts an existing panel mounted storage unit BSADA-PM to off-module overhead storage unit BSADA-OMKIT.
- Kit includes a back panel with integrated hanging bracket and an extruded bottom bracket.
- **IMPORTANT:** BSADA overhead with off-module conversion kit can only be installed on B3 fabric tile. Tiles below the overhead can be fabric, laminate and accessory tile. However, the tile the overhead is hanging on must be fabric.
- BSADA Overhead with off-module conversion kit can be suspended off of a single fabric tile, or can span two fabric tiles on two adjacent, directly interconnected panels.
- BSADA Overhead with off-module conversion kit **CANNOT** be suspended off of two panels separated by a post.

PRODUCT CODE	PRICE	SIZE/INCHES			WEIGHT VOL	
		H	W	D	LBS	FT <sup>3</sup>
BSADA240MKIT	235	16	24	2	6	0.5
BSADA300MKIT	237	16	30	2	8	0.6
BSADA360MKIT	247	16	36	2	10	0.7
BSADA420MKIT	260	16	42	2	11	0.8
BSADA480MKIT	273	16	48	2	13	0.9
BSADA540MKIT	289	16	54	2	14	1.0
BSADA600MKIT	302	16	60	2	15	1.1

**BSADA-KIT • Panel-Mounted Conversion Kit**



- Converts an existing up-mount overhead storage unit BSADA-UM to a Panel mounted overhead storage Unit BSADA-PM.
- Kit includes panel mounting brackets.

PRODUCT CODE	PRICE	SIZE/INCHES			WEIGHT VOL	
		H	W	D	LBS	FT <sup>3</sup>
BSADAPMKIT	101	16	0.5	2	2	0.009

**BSP1DO • Overhead Divider Storage for Boulevard 1 - Open Double-Sided**

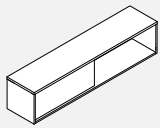

- Panel top mount allows access on both sides.
- Storage compartment internal height: 14".
- Overhead available in standard GC laminate finishes.
- Top mount on panels.
- Connecting hardware included.

PRODUCT CODE	PRICE		SIZE/INCHES			WEIGHT VOL	
	LP	HP	H	W	D	LBS	FT <sup>3</sup>
BSP1DO36	814	915	16	36	16	81	7
BSP1DO42	837	954	16	42	16	96	8
BSP1DO48	871	1003	16	48	16	100	9

**BSP1LDS • Overhead Divider Storage for Boulevard 1 - Open Double-Sided With Sliding Laminate Door**

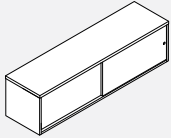

- Panel top mount allows access on both sides.
- Storage compartment internal height: 14".
- Overhead available in standard GC laminate finishes.
- Top mount on panels.
- Connecting hardware included.
- Sliding laminate doors are not locking.

PRODUCT CODE	PRICE		SIZE/INCHES			WEIGHT VOL	
	LP	HP	H	W	D	LBS	FT <sup>3</sup>
BSP1LDS36	2558	2659	16	36	16	87	7
BSP1LDS42	2618	2737	16	42	16	103	8
BSP1LDS48	2652	2787	16	48	16	108	9

**BSP1GDS • Overhead Divider Storage for Boulevard 1 - Open Double-Sided With Sliding Glass Door**

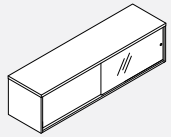

- Panel top mount allows access on both sides.
- Storage compartment internal height: 14".
- Overhead available in standard GC laminate finishes.
- Top mount on panels.
- Connecting hardware included.
- Sliding glass doors are not locking.

PRODUCT CODE	PRICE		SIZE/INCHES			WEIGHT VOL	
	LP	HP	H	W	D	LBS	FT <sup>3</sup>
BSP1GDS36	2650	2752	16	36	16	92	7
BSP1GDS42	2694	2813	16	42	16	108	8
BSP1GDS48	2733	2868	16	48	16	113	9

**BSP3DO • Overhead Divider Storage for Boulevard System 3 - Open Double-Sided**

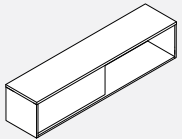

- Panel top mount allows access on both sides.
- Storage compartment internal height: 14".
- Overhead available in standard GC laminate finishes.
- Top mount on panels.
- Connecting hardware included.

PRODUCT CODE	PRICE		SIZE/INCHES			WEIGHT VOL	
	LP	HP	H	W	D	LBS	FT <sup>3</sup>
BSP3DO36	790	892	16	36	16	81	9
BSP3DO42	823	943	16	42	16	96	10.5
BSP3DO48	858	993	16	48	16	100	12

**BSP3LDS • Overhead Divider Storage for Boulevard System 3 - Open Double-Sided With Sliding Laminate Door**

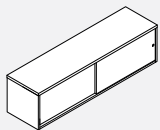

- Panel top mount allows access on both sides.
- Storage compartment internal height: 14".
- Overhead available in standard GC laminate finishes.
- Top mount on panels.
- Connecting hardware included.
- Sliding laminate doors are not locking.

PRODUCT CODE	PRICE		SIZE/INCHES			WEIGHT VOL	
	LP	HP	H	W	D	LBS	FT <sup>3</sup>
BSP3LDS36	2533	2635	16	36	16	106	7
BSP3LDS42	2596	2713	16	42	16	126	8
BSP3LDS48	2628	2763	16	48	16	134	9

**BSP3GDS • Overhead Divider Storage for Boulevard System 3 - Open Double-Sided With Sliding Glass Door**

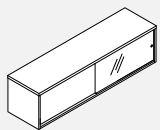

- Panel top mount allows access on both sides.
- Storage compartment internal height: 14".
- Overhead available in standard GC laminate finishes.
- Top mount on panels.
- Connecting hardware included.
- Sliding glass doors are not locking.

PRODUCT CODE	PRICE		SIZE/INCHES			WEIGHT VOL	
	LP	HP	H	W	D	LBS	FT <sup>3</sup>
BSP3GDS36	2625	2726	16	36	16	87	6
BSP3GDS42	2670	2787	16	42	16	103	7
BSP3GDS48	2709	2843	16	48	16	107	9

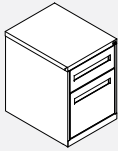
**BS93FPxxBFC • 9300 Series Freestanding Box/File Pedestal**

- One box and one file drawer pedestal.
- Freestanding, counterweight included.
- All drawers are locking.
- Box drawer includes pencil tray.

PRODUCT CODE	PRICE	SIZE / INCHES			WEIGHT LBS	VOL FT <sup>3</sup>
		H	W	D		
BS93FP19BFC	567	21.31	15	19	50	5.1
BS93FP23BFC	574	21.31	15	23	55	6.0
BS93FP29BFC	649	21.31	15	29	64	7.5

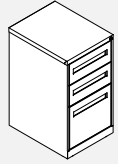
**BS93FPxxBBFC • 9300 Series Freestanding Box/Box/File Pedestal**

- Two box and one file drawer pedestal.
- Freestanding, counterweight included.
- All drawers are locking.
- Top box drawer includes pencil tray.

PRODUCT CODE	PRICE	SIZE / INCHES			WEIGHT LBS	VOL FT <sup>3</sup>
		H	W	D		
BS93FP19BBFC	631	27.87	15	19	55	6.5
BS93FP23BBFC	640	27.87	15	23	68	7.7
BS93FP29BBFC	704	27.87	15	29	78	9.6

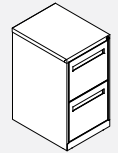
**BS93FPxxFFC • 9300 Series Freestanding File/File Pedestal**

- Two file drawer pedestal.
- Freestanding, counterweight included.
- All drawers are locking.

PRODUCT CODE	PRICE	SIZE / INCHES			WEIGHT LBS	VOL FT <sup>3</sup>
		H	W	D		
BS93FP19FFC	631	27.87	15	19	53	6.5
BS93FP23FFC	640	27.87	15	23	60	7.7
BS93FP29FFC	704	27.87	15	29	70	9.6

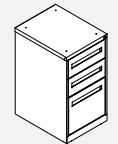
**BS93WPxxBBFC • 9300 Series Worksurface Supporting Box/Box/File Pedestal**

- Two box and one file drawer pedestal.
- Worksurface supporting, includes mounting holes in the top.
- All drawers are locking.
- Top box drawer includes pencil tray.
- Includes filler and brackets.

PRODUCT CODE	PRICE	SIZE / INCHES			WEIGHT LBS	VOL FT <sup>3</sup>
		H	W	D		
BS93WP19BBFC	631	27.87	15	19	55	6.5
BS93WP23BBFC	640	27.87	15	23	68	7.7
BS93WP29BBFC	704	27.87	15	29	78	9.6

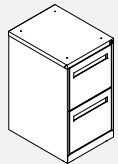
**BS93WPxxFFC • 9300 Series Worksurface Supporting File/File Pedestal**

- Two file drawer pedestal.
- Worksurface supporting, includes mounting holes in the top.
- All drawers are locking.
- Includes filler and brackets.

PRODUCT CODE	PRICE	SIZE / INCHES			WEIGHT LBS	VOL FT <sup>3</sup>
		H	W	D		
BS93WP19FFC	631	27.87	15	19	53	6.5
BS93WP23FFC	640	27.87	15	23	60	7.7
BS93WP29FFC	704	27.87	15	29	70	9.6

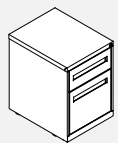
**BS93MPxxBFC • 9300 Series Mobile Box/File Pedestal**

- One box and one file drawer mobile pedestal.
- Casters pre-installed, casters non-locking.
- Counterweight included.
- All drawers locking.
- Box drawer includes pencil tray.
- NOTE: Cannot be used as guest seating.

PRODUCT CODE	PRICE	SIZE / INCHES			WEIGHT LBS	VOL FT <sup>3</sup>
		H	W	D		
BS93MP19BFC	748	21.87	15	19	66	5.2
BS93MP23BFC	756	21.87	15	23	72	6.2
BS93MP29BFC	869	21.87	15	29	92	7.6

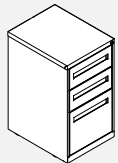
**BS93MPxxBBFC • 9300 Series Mobile Box/Box/File Pedestal**

- Two box and one file drawer mobile pedestal.
- Casters pre-installed, casters non-locking.
- Counterweight included.
- All drawers locking.
- Top box drawer includes pencil tray.
- NOTE: Cannot be used as guest seating.

PRODUCT CODE	PRICE	SIZE / INCHES			WEIGHT LBS	VOL FT <sup>3</sup>
		H	W	D		
BS93MP19BBFC	789	27.93	15	19	76	6.5
BS93MP23BBFC	803	27.93	15	23	85	7.7
BS93MP29BBFC	813	27.93	15	29	94	9.6

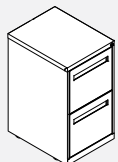
**BS93MPxxFFC • 9300 Series Mobile File/File Pedestal**

- Two file drawer pedestal.
- Casters pre-installed, casters non-locking.
- Counterweight included.
- All drawers locking.
- NOTE: Cannot be used as guest seating.

PRODUCT CODE	PRICE	SIZE / INCHES			WEIGHT LBS	VOL FT <sup>3</sup>
		H	W	D		
BS93MP19FFC	789	27.93	15	19	73	6.5
BS93MP23FFC	803	27.93	15	23	81	7.7
BS93MP29FFC	813	27.93	15	29	90	9.6

**BSPFOBFxxC • Prime Box/File Pedestal**



- One box and one file drawer pedestal.
- All drawers are locking.
- Box drawer includes pencil tray.
- For freestanding, to add counterweight (W2 option), add \$50 list.
- For mobile to add casters and counterweight (W1 option), add \$75 list. Adds 0.5" to height.
- NOTE: Cannot be used as guest seating.

PRODUCT CODE	PRICE	SIZE/INCHES			WEIGHT VOL	
		H	W	D	LBS	FT <sup>3</sup>
BSPFOBF18C	567	20.8	15	18	52.4	4.2
BSPFOBF22C	574	20.8	15	22	58.8	5.0
BSPFOBF28C	649	20.8	15	28	68.7	6.3

**BSPFSBGxxC • Prime Box/Box/File Pedestal**

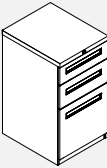

- Two box and one file drawer pedestal.
- All drawers are locking.
- Top box drawer includes pencil tray.
- For freestanding, to add counterweight (W2 option), add \$50 list.
- For mobile to add casters and counterweight (W1 option), add \$75 list. Adds 0.5" to height.
- Top box drawer 4.8" high; middle box drawer 6.4" high; bottom file drawer 13.6" high (interior 12.5" high).
- When worksurface supporting option selected, unit includes pre-drilled top holes for attaching and filler/brackets.

PRODUCT CODE	PRICE	SIZE/INCHES			WEIGHT VOL	
		H	W	D	LBS	FT <sup>3</sup>
BSPFSBG18C	631	28	15	18	67.5	5.5
BSPFSBG22C	640	28	15	22	75.0	6.6
BSPFSBG28C	704	28	15	28	86.8	8.3

**BSPFOFGxxC • Prime File/File Pedestal**

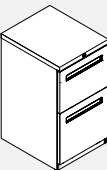

- Two file drawer pedestal.
- All drawers are locking.
- For freestanding, to add counterweight (W2 option), add \$50 list.
- For mobile to add casters and counterweight (W1 option), add \$75 list. Adds 0.5" to height.
- Top file drawer 11.2" high (interior 10.6" high); bottom file drawer 13.6" high (interior 12.5" high).
- When worksurface supporting option selected, unit includes pre-drilled top holes for attaching and filler/brackets.

PRODUCT CODE	PRICE	SIZE/INCHES			WEIGHT VOL	
		H	W	D	LBS	FT <sup>3</sup>
BSPFOFG18C	631	28	15	18	67.5	5.5
BSPFOFG22C	640	28	15	22	75.0	6.6
BSPFOFG28C	704	28	15	28	86.8	8.3

**BSPWOBFxxC • Prime Mobile Box/File Pedestal**



- Mobile one box and one file drawer pedestal.
- All drawers are locking.
- 60 mm casters.

PRODUCT CODE	PRICE	SIZE/INCHES			WEIGHT VOL	
		H	W	D	LBS	FT <sup>3</sup>
BSPWOBF18C	748	23.3	15	18	73.5	4.6
BSPWOBF22C	756	23.3	15	22	79.1	5.6
BSPWOBF28C	869	23.3	15	28	87.7	7.0

**BSTC • Pedestal/Lateral Seat Cushion**

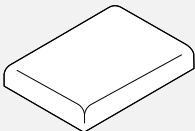

PRODUCT CODE	YRDS	SIZE/INCHES			WEIGHT VOL	
		H	W	D	LBS	FT <sup>3</sup>
BSTCP1518	0.75	2	15	18	5.00	0.41
BSTCP1522	0.75	2	15	22	5.25	0.45
BSTCP1528	1.00	2	15	28	5.5	0.55
BSTCL1830	1.00	2	18	30	6.0	0.55
BSTCL1836	1.25	2	18	36	6.5	0.65

PRODUCT CODE	PRICE									
	GR1	GR2	GR3	GR4	GR5	GR6	GR7	GR8	GR9	GR10
BSTCP1518	330	363	403	462	518	575	624	684	744	822
BSTCP1522	355	386	426	486	543	598	648	707	767	845
BSTCP1528	447	487	540	620	695	769	838	914	993	1097
BSTCL1830	469	512	563	644	719	792	861	938	1018	1122
BSTCL1836	559	615	679	779	872	966	1049	1146	1246	1375

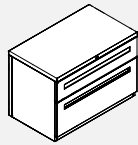

**BSLPS0BF18xxC • Prime Box/File Lateral File**

- One and a half height lateral filing cabinet.
- Fixed-front drawers; top box drawer front 4.8" high; bottom file drawer front 13.6" high (interior 12.5" high).
- Locking.
- Side-to-side hanging bars included.
- To add counterweight (W2 option), add \$410 list.

PRODUCT CODE	PRICE	SIZE/INCHES			WEIGHT LBS	VOL FT <sup>3</sup>
		H	W	D		
BSLPS0BF1830C	1257	20.98	30	18.06	119.96	8.0
BSLPS0BF1836C	1306	20.98	36	18.06	129.86	9.5
BSLPS0BF1842C	1350	20.98	42	18.06	165.45	11.1

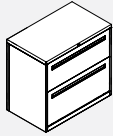
**BSLF20G18xxC • Prime 2-High Lateral File**

- Two-high lateral filing cabinet.
- Fixed-front file drawers; top drawer front 11.2" high (interior 10.6" high); bottom drawer front 13.6" high (interior 12.5" high).
- Locking.
- Side-to-side hanging bars included.
- To add counterweight (W2 option), add \$200 list.

PRODUCT CODE	PRICE	SIZE/INCHES			WEIGHT LBS	VOL FT <sup>3</sup>
		H	W	D		
BSLF20G1830C	1257	28	30	18	98.7	10.5
BSLF20G1836C	1314	28	36	18	114.4	12.5
BSLF20G1842C	12387	28	42	18	129.4	14.5

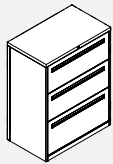
**BSLF30G18xxC • Prime 3-High Lateral File**

- Three-high lateral filing cabinet.
- Fixed-front file drawers; top and middle drawer front 11.2" high (interior 10.6" high); bottom drawer front 13.6" high (interior 12.5" high).
- Locking.
- Side-to-side hanging bars included.
- Will not line up with 42" high panels.
- To add counterweight (W2 option), add \$200 list.

PRODUCT CODE	PRICE	SIZE/INCHES			WEIGHT LBS	VOL FT <sup>3</sup>
		H	W	D		
BSLF30G1830C	1648	39.2	30	18	127.9	14.5
BSLF30G1836C	1733	39.2	36	18	147.6	17.2
BSLF30G1842C	1832	39.2	42	18	167.5	20.0

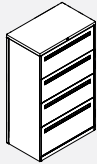
**BSLF40H18xxC • Prime 4-High File/File/File/File Lateral File**

- Four-high fixed-front lateral filing cabinet.
- Fixed-front file drawers; top drawer front 10.4" high (interior 9.8" high); second and third drawers 11.2" high (interior 10.6" high); bottom drawer front 13.6" high (interior 12.5" high).
- Locking.
- Side-to-side hanging bars included.
- To add counterweight (W2 option), add \$200 list.

PRODUCT CODE	PRICE	SIZE/INCHES			WEIGHT LBS	VOL FT <sup>3</sup>
		H	W	D		
BSLF40G1830C	1902	49.6	30	18	159.1	18.2
BSLF40G1836C	1998	49.6	36	18	183.4	21.6
BSLF40G1842C	2119	49.6	42	18	208.5	25.1

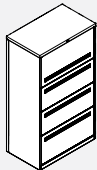
**BSLF40H18xxC • Prime 4-High Receding Top Door/File/File/File Lateral File**

- Four-high receding-top door and remaining fixed-front lateral filing cabinet.
- Top-opening receding door + roll-out shelf 14.4" high front, accepts binder height; fixed-front second and third drawers 11.2" high (interior 10.6" high); bottom drawer front 13.6" high (interior 12.5" high).
- Locking.
- Side-to-side hanging bars included.
- To add counterweight (W2 option), add \$200 list.

PRODUCT CODE	PRICE	SIZE/INCHES			WEIGHT LBS	VOL FT <sup>3</sup>
		H	W	D		
BSLF40H1830C	2091	53.6	30	18	171.9	19.6
BSLF40H1836C	2204	53.6	36	18	198.2	23.3
BSLF40H1842C	2333	53.6	42	18	225.3	27.0

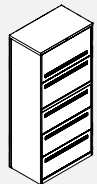
**BSLF50P18xxC • Prime 5-High Receding Top Door/File/File/File/File Lateral File**

- Five-high receding-top door and remaining fixed-front lateral filing cabinet.
- Locking.
- Side-to-side hanging bars included.
- Top-opening receding door + roll-out shelf 14.4" high front, accepts binder height; bottom fixed-front second and third drawers 11.2" high (interior 10.6" high); bottom drawer front 13.6" high (interior 12.5" high).
- To add counterweight (W2 option), add \$200 list.

PRODUCT CODE	PRICE	SIZE/INCHES			WEIGHT LBS	VOL FT <sup>3</sup>
		H	W	D		
BSLF50P1830C	2588	65.6	30	18	208.9	23.9
BSLF50P1836C	2694	65.6	36	18	239.9	28.4
BSLF50P1842C	2843	65.6	42	18	272.7	32.9

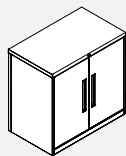
**BSSC21G18xxC • Prime 2 High Storage Cabinet**

- Two-high storage cabinet.
- One adjustable shelf + fixed bottom shelf.
- Locking.

PRODUCT CODE	PRICE	SIZE/INCHES			WEIGHT LBS	VOL FT <sup>3</sup>
		H	W	D		
BSSC21G1830C	1030	28	30	18	75.08	10.5
BSSC21G1836C	1150	28	36	18	86.48	12.5
BSSC21G1842C	1253	28	42	18	95.78	14.5

**BSSC31G18xxC • Prime 3-High Storage Cabinet**

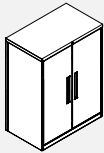

- Three-high storage cabinet.
- Two adjustable shelves + fixed bottom shelf.
- Will not line up to 42" high panels.
- Locking.

PRODUCT CODE	PRICE	SIZE/INCHES			WEIGHT		VOL FT <sup>3</sup>
		H	W	D	LBS		
BSSC31G1830C	1314	39.2	30	18	96.69		14.5
BSSC31G1836C	1442	39.2	36	18	111.59		17.2
BSSC31G1842C	1597	39.2	42	18	124.49		20.0

**BSSC41G18xxC • Prime 4-High Storage Cabinet**

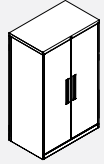

- Three-high storage cabinet to line up to 50" high panels.
- Three adjustable shelves + fixed bottom shelf.
- Locking.

PRODUCT CODE	PRICE	SIZE/INCHES			WEIGHT		VOL FT <sup>3</sup>
		H	W	D	LBS		
BSSC41G1830C	1543	49.6	30	18	111.22		18.2
BSSC41G1836C	1653	49.6	36	18	129.32		21.6
BSSC41G1842C	1829	49.6	42	18	145.42		25.1

**BSSC41H18xxC • Prime 4-High Storage Cabinet**

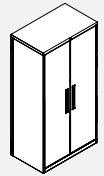

- Four-high storage cabinet.
- Three adjustable shelves + fixed bottom shelf.
- Locking.

PRODUCT CODE	PRICE	SIZE/INCHES			WEIGHT		VOL FT <sup>3</sup>
		H	W	D	LBS		
BSSC41H1830C	1640	53.6	30	18	120.17		19.6
BSSC41H1836C	1719	53.6	36	18	138.27		23.3
BSSC41H1842C	1902	53.6	42	18	154.37		27.0

**BSSC51C18xxC • Prime 5-High Storage Cabinet**

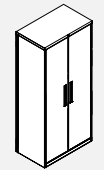

- Five high storage cabinet.
- Four adjustable shelves + fixed bottom shelf.
- Locking.

PRODUCT CODE	PRICE	SIZE/INCHES			WEIGHT		VOL FT <sup>3</sup>
		H	W	D	LBS		
BSSC51C1830C	1835	65.6	30	18	138.5		23.9
BSSC51C1836C	1946	65.6	36	18	160.4		28.4
BSSC51C1842C	2156	65.6	42	18	180.4		32.9

**BSSLFxx24BCCL • Prime Tower With Left Wardrobe, Half-Height Door and Box/Box/File Drawers**

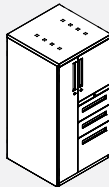

- Left wardrobe tower with half-height door and box/box/file drawers.
- Wardrobe section includes top shelf and coat bar.
- Hinged-door compartment of 50" high and 54" high includes one adjustable shelf; 66" high includes two adjustable open shelves.
- Wardrobe section includes top perforations for ventilation.
- Three locks included – wardrobe door, hinged-door shelving compartment and drawers.
- To add counterweight (W2 option), add \$105 list.

PRODUCT CODE	PRICE	SIZE/INCHES			WEIGHT		VOL FT <sup>3</sup>
		H	W	D	LBS		
BSSLF4G24BCCL	2795	49.6	24	24	176.71		19.2
BSSLF4H24BCCL	2814	53.6	24	24	181.63		19.8
BSSLF5024BCCL	2940	65.6	24	24	204.52		25.2

"4G" Tower Shown

**BSSLFxx24BCCR • Prime Tower With Right Wardrobe, Half-Height Door and Box/Box/File Drawers**

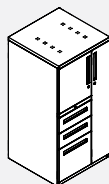

- Right wardrobe tower with half-height door and box/box/file drawers.
- Wardrobe section includes top shelf and coat bar.
- Hinged-door compartment of 50" high and 54" high includes one adjustable shelf; 66" high includes two adjustable open shelves.
- Wardrobe section includes top perforations for ventilation.
- Three locks included – wardrobe door, hinged-door shelving compartment and drawers.
- To add counterweight (W2 option), add \$105 list.

PRODUCT CODE	PRICE	SIZE/INCHES			WEIGHT		VOL FT <sup>3</sup>
		H	W	D	LBS		
BSSLF4G24BCCR	2795	49.6	24	24	176.71		19.2
BSSLF4H24BCCR	2814	53.6	24	24	181.63		19.8
BSSLF5024BCCR	2940	65.6	24	24	204.52		25.2

"4G" Tower Shown

**BSSLFxx24FCCL • Prime Tower With Left Wardrobe, Half-Height Door and File/File Drawers**

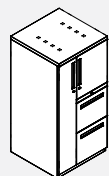

- Left wardrobe tower with half-height door and file/file drawers.
- Wardrobe section includes top shelf and coat bar.
- Hinged-door compartment of 50" high and 54" high includes one adjustable shelf; 66" high includes two adjustable open shelves.
- Wardrobe section includes top perforations for ventilation.
- Three locks included – wardrobe door, hinged-door shelving compartment and drawers.
- To add counterweight (W2 option), add \$105 list.

PRODUCT CODE	PRICE	SIZE/INCHES			WEIGHT		VOL FT <sup>3</sup>
		H	W	D	LBS		
BSSLF4G24FCCL	2795	49.6	24	24	181.05		19.2
BSSLF4H24FCCL	2814	53.6	24	24	186.43		19.8
BSSLF5024FCCL	2940	65.6	24	24	231.53		25.2

"4G" Tower Shown

**BSSLFxx24FCCR • Prime Tower With Right Wardrobe, Half-Height Door and File/File Drawers**

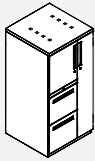

"4G" Tower Shown

- Right wardrobe tower with half-height door and file/file drawers.
- Wardrobe section includes top shelf and coat bar.
- Hinged-door compartment of 50" high and 54" high includes one adjustable shelf; 66" high includes two adjustable open shelves.
- Wardrobe section includes top perforations for ventilation.
- Three locks included – wardrobe door, hinged-door shelving compartment and drawers.
- To add counterweight (W2 option), add \$105 list.

PRODUCT CODE	PRICE	SIZE/INCHES			WEIGHT LBS	VOL FT <sup>3</sup>
		H	W	D		
BSSLF4G24FCCR	2795	49.6	24	24	181.05	19.2
BSSLF4H24FCCR	2814	53.6	24	24	186.43	19.8
BSSLF5024FCCR	2940	65.6	24	24	231.53	25.2

**BSSLSxx2424BOCL • Prime Tower With Left Wardrobe, Open Side Shelf, Box/Box/File Drawers**

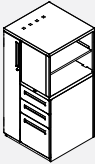

"4G" Tower Shown

- Left wardrobe tower with open side shelving and box/box/file drawers.
- Wardrobe section includes top shelf and coat bar.
- 50" high and 54" high include open side shelf with one adjustable shelf; 66" high includes open side shelf with two adjustable shelves.
- Wardrobe section includes top perforations for ventilation.
- Two locks included – wardrobe door and drawers.
- To add counterweight (W2 option), add \$105 list.

PRODUCT CODE	PRICE	SIZE/INCHES			WEIGHT LBS	VOL FT <sup>3</sup>
		H	W	D		
BSSLS4G2424BOCL	3089	49.6	24	24	186.18	19.2
BSSLS4H2424BOCL	3108	53.6	24	24	186.91	19.8
BSSLS502424BOCL	3157	65.6	24	24	236.34	25.2

**BSSLSxx2424BOCR • Prime Tower With Right Wardrobe, Open Side Shelf and Box/Box/File Drawers**

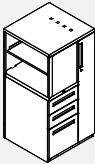

"4G" Tower Shown

- Right wardrobe tower with open side shelving and box/box/file drawers.
- Wardrobe section includes top shelf and coat bar.
- 50" high and 54" high include open side shelf with one adjustable shelf; 66" high includes open side shelf with two adjustable shelves.
- Wardrobe section includes top perforations for ventilation.
- Two locks included – wardrobe door and drawers.
- To add counterweight (W2 option), add \$105 list.

PRODUCT CODE	PRICE	SIZE/INCHES			WEIGHT LBS	VOL FT <sup>3</sup>
		H	W	D		
BSSLS4G2424BOCR	3089	49.6	24	24	186.18	19.2
BSSLS4H2424BOCR	3108	53.6	24	24	186.91	19.8
BSSLS502424BOCR	3157	65.6	24	24	236.34	25.2

**BSSLSxx2424FOCL • Prime Tower With Left Wardrobe, Open Side Shelf and File/File Drawers**

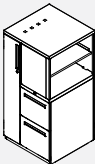

"4G" Tower Shown

- Left wardrobe tower with open side shelving and file/file drawers.
- Wardrobe section includes top shelf and coat bar.
- 50" high and 54" high include open side shelf with one adjustable shelf; 66" high includes open side shelf with two adjustable shelves.
- Wardrobe section includes top perforations for ventilation.
- Two locks included – wardrobe door and drawers.
- To add counterweight (W2 option), add \$105 list.

PRODUCT CODE	PRICE	SIZE/INCHES			WEIGHT LBS	VOL FT <sup>3</sup>
		H	W	D		
BSSLS4G2424FOCL	3089	49.6	24	24	179.54	19.2
BSSLS4H2424FOCL	3108	53.6	24	24	180.26	19.8
BSSLS502424FOCL	3157	65.6	24	24	232.55	25.2

**BSSLSxx2424FOCR • Prime Tower With Right Wardrobe, Open Side Shelf, File/File Drawers**

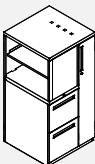

"4G" Tower Shown

- Right wardrobe tower with open side shelving and file/file drawers.
- Wardrobe section includes top shelf and coat bar.
- 50" high and 54" high include open side shelf with one adjustable shelf; 66" high includes open side shelf with two adjustable shelves.
- Wardrobe section includes top perforations for ventilation.
- Two locks included – wardrobe door and drawers.
- To add counterweight (W2 option), add \$105 list.

PRODUCT CODE	PRICE	SIZE/INCHES			WEIGHT LBS	VOL FT <sup>3</sup>
		H	W	D		
BSSLS4G2424FOCR	3089	49.6	24	24	179.54	19.2
BSSLS4H2424FOCR	3108	53.6	24	24	180.26	19.8
BSSLS502424FOCR	3157	65.6	24	24	232.55	25.2

**BSWC51C18xxC • Prime Wardrobe**

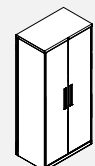

- Wardrobe cabinet.
- 30" wide includes full-width shelf and side-to-side coat rod.
- 36" wide and 42" wide are split with shelving on left side, wardrobe on the other.
- Locking.

PRODUCT CODE	PRICE	SIZE/INCHES			WEIGHT LBS	VOL FT <sup>3</sup>
		H	W	D		
BSWC51C1830C	1774	65.6	30	18	125.26	23.8
BSWC51C1836C	1981	65.6	36	18	164.97	28.4
BSWC51C1842C	2177	65.6	42	18	180.59	32.9

**BSCC31G18xxC • Prime 3-High Combination Cabinet**

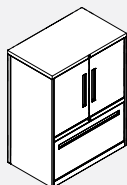

- Multi storage cabinet including hinged-door upper section with one adjustable shelf; one fixed front file drawers below.
- Will not line up to 42" panels.
- Locking.
- To add counterweight (W2 option), add \$200 list.

PRODUCT CODE	PRICE	SIZE/INCHES			WEIGHT LBS	VOL FT <sup>3</sup>
		H	W	D		
BSCC31G1830C	2178	39.2	30	18	117.3	14.5
BSCC31G1836C	2376	39.2	36	18	135.5	17.2
BSCC31G1842C	2581	39.2	42	18	152.5	20.0

**BSCC41G18xxC • Prime 4-High Combination Cabinet**

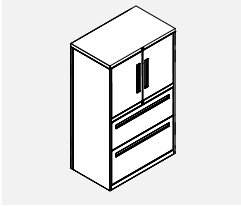

- Multi storage cabinet including hinged-door upper section with one adjustable shelf; two fixed-front file drawers below, lines up to 50" high panels.
- Locking.
- To add counterweight (W2 option), add \$200 list.

PRODUCT CODE	PRICE	SIZE/INCHES			WEIGHT LBS	VOL FT <sup>3</sup>
		H	W	D		
BSCC41G1830C	2642	49.6	30	18	149.96	18.2
BSCC41G1836C	2824	49.6	36	18	172.96	21.6
BSCC41G1842C	3045	49.6	42	18	195.36	25.1

**BSCC41H18xxC • Prime 4-High Combination Cabinet**

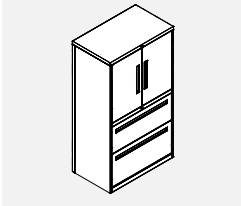

- Multi storage cabinet including hinged-door upper section with one adjustable shelf; two fixed-front file drawers below, lines up to 54" high panels.
- Locking.
- To add counterweight (W2 option), add \$200 list.

PRODUCT CODE	PRICE	SIZE/INCHES			WEIGHT LBS	VOL FT <sup>3</sup>
		H	W	D		
BSCC41H1830C	2772	53.6	30	18	154.54	19.6
BSCC41H1836C	2965	53.6	36	18	178.54	23.3
BSCC41H1842C	3196	53.6	42	18	202.04	27.0

**BSCC51C18xxC • Prime 5-High Combination Cabinet**

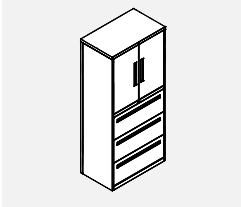

- Multi storage cabinet including hinged-door upper section with one adjustable shelf; three fixed-front file drawers below.
- Locking.
- To add counterweight (W2 option), add \$200 list.

PRODUCT CODE	PRICE	SIZE/INCHES			WEIGHT LBS	VOL FT <sup>3</sup>
		H	W	D		
BSCC51C1830C	3056	65.6	30	18	188.5	23.9
BSCC51C1836C	3274	65.6	36	18	216.9	28.4
BSCC51C1842C	3439	65.6	42	18	245.5	32.9

**BSLFA0718 • Prime Front-to-Back File Bars**

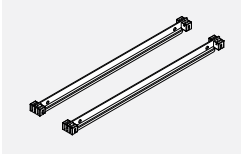

- Package of two, grey finish.

PRODUCT CODE	PRICE	SIZE/INCHES			WEIGHT LBS	VOL FT <sup>3</sup>
		H	W	D		
BSLFA0718	25	1	17.3	1	1	0.04

**BSLFS • Prime Hanging File Bars**

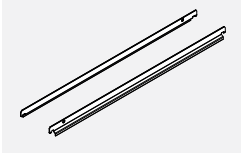

- Package of two, grey finish.

PRODUCT CODE	PRICE	SIZE/INCHES			WEIGHT LBS	VOL FT <sup>3</sup>
		H	W	D		
BSLFA01	43	1.3	27.5	0.5	2	0.03
BSLFA02	43	1.3	33.5	0.5	2.4	0.04
BSLFA03	43	1.3	39.5	0.5	2.8	0.05

**BSLFA1018 • Prime Plate Dividers**

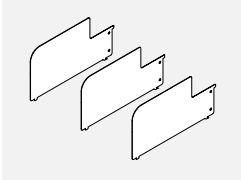

- Package of three, grey finish.

PRODUCT CODE	PRICE	SIZE/INCHES			WEIGHT LBS	VOL FT <sup>3</sup>
		H	W	D		
BSLFA1018	48	7.25	13.5	0.2	4	0.07

**BSLFA2418 • Prime Half-Height Plate Dividers**

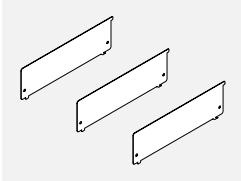

- Package of three, grey finish.

PRODUCT CODE	PRICE	SIZE/INCHES			WEIGHT LBS	VOL FT <sup>3</sup>
		H	W	D		
BSLFA2418	42	3.95	13.5	0.2	2.2	0.04

**BSLFA2018 • Prime EDP Adapters**

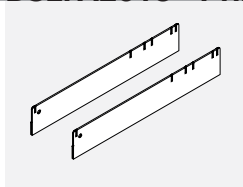

PRODUCT CODE	PRICE	SIZE/INCHES			WEIGHT LBS	VOL FT <sup>3</sup>
		H	W	D		
BSLFA2018	44	2.6	16.5	0.15	2.5	0.02

**BSK • Keys and Replacement Lock Core**

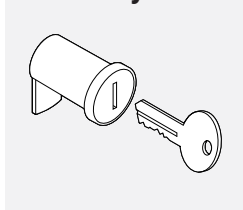

- Set of extra keys.
- Replacement lock and key.

PRODUCT CODE	PRICE	SIZE/INCHES			WEIGHT LBS	VOL FT <sup>3</sup>
		H	W	D		
BSKY -EXTRA KEY	12	1.75	0.75	0.2	0.2	0.01
BSKC - LOCK & KEY	39	2	1	0.5	0.4	0.01

**BSSA • Prime Extra Cabinet Shelves**

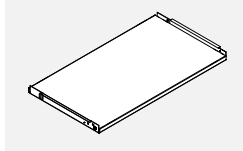

- Shelf, non-slotted.

PRODUCT CODE	PRICE	SIZE/INCHES			WEIGHT LBS	VOL FT <sup>3</sup>
		H	W	D		
Shelf, non-slotted.						
BSSA11830	120	0.8	28.4	16	7.2	1.8
BSSA11836	126	0.8	34.4	16	8.4	2.2
BSSA11842	134	0.8	40.4	16	9.5	2.6

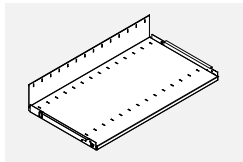

- Shelf, slotted.

PRODUCT CODE	PRICE	SIZE/INCHES			WEIGHT LBS	VOL FT <sup>3</sup>
		H	W	D		
Shelf, slotted.						
BSSA21830	130	5.25	28.4	16	8.2	1.8
BSSA21836	136	5.25	34.4	16	9.6	2.2
BSSA21842	148	5.25	40.4	16	10.8	2.6



**DIET PANEL SYSTEM**

Diet represents an innovative tool for creating an economical, efficient work space, accommodating various tasks. From 42" high panels which provide an open office feel to 50" and 54" high panels, for seated privacy and 66" high panels for standing privacy, Diet effectively supports the creation of various work environments. Diet is simple, easy to comprehend, easy to specify and install, with a minimum of add-on and dedicated/handed components to maximize reconfiguration flexibility. All Diet panels ship with a set of self-leveling connectors that accommodate any angle, but also straight, 90°, three-way T and 120° configurations, as well as four-way "X". Truly universal connectors support the above panel configurations regardless of panel heights. Such a configuration and height independent connecting method eliminates the need to order additional components during future office reconfigurations. Diet is an economical, "soft wire" system with simple means of optional power and data/communication cable management trough that snaps to the

bottom of the panel. With the exception of panels with open area below the mid rail, all Diet panels are built with 6" clearance opening between the floor and the bottom rail. This feature not only serves as a simple passage for cables between back-to-back stations and an interface for a snap on cable trough, but it mainly provides ultimate flexibility of panel station placement even if one panel needs to be located right above a floor monument. Diet's slim appearance, sophisticated industrial design, detailing and advanced engineering communicate high perceived value, exceeding expectations usually related to budget products. Diet can be specified on its own, with integrated worksurface, storage and accessory support, privacy and space organization in free standing office environments. Whether combined with Boulevard system, or raised floors, Diet, as a tool, bridges mobile or stationary freestanding furniture with power/data delivery solutions, that are hard wired to a building power supply.

**TECHNICAL INFORMATION**

**Panels**

- Panels are 1.3" thick.
- Width ranges from 24" to 60" at 6" increments.
- Heights include 42", 50", 54" and 66" (nominal).
- Extruded aluminum frame surrounds a fabric wrapped interior with a 7/8" particle board frame, sandwiched between 2 pieces of 1/8" masonite.
- Panel frame finish is durable epoxy powder coated.
- Finished panel includes top, corner and end caps.
- For glazing - Smoke development index 500.
- For tempered glass, add "TG" to the end of the product code and add 20% to the price regardless of fabric grade.
- Top rail accepts Teknion accessories, monitor arm supports, off-module shelves, and task light brackets.
- Top rail on Glazed Top Panels is not intended for use with panel-mounted shelves and panel-mounted overhead.
- Middle rail accepts bracket for off-module worksurface support, Teknion accessories, off-module shelves and power bar.
- Bottom rail accepts brackets for off-module worksurface support, Teknion accessories, off-module shelves and optional cable manager and power bar.
- Optional PVC cable manager friction fits into bottom rail.

- Two leveler are included with a 1.75" leveling range.
- Vertical frame members have integrated grooves for additional components.
- Charcoal covers are provided at front of vertical members where connectors attach.
- Panels include 3 sets of hinge connectors, 1 set of spacers and 6 pins.
- Connecting method is simple, accommodating typical configuration, as well as connection of panels at any angle, regardless of height.

**Panel Options**

- Laminate or whiteboard may be substituted for fabric on panels only, see "OPT" column.
- Tackboard panels available, please add 25% upcharge. Steel facing available, contact your customer service representative.

**Note:**

- 42"-High Diet panels do not match Boulevard 42"
- 50"-High Diet panels match Boulevard 50"
- 54"-High Diet panels do not match standard Boulevard 54"
- 66"-High Diet panels matches Boulevard 66"
- To order 42" and 54" high Diet panels to match Boulevard, please order "BDPFF" and "BDPOF".

**HOW DIET CAN REDUCE YOUR COSTS**

**Finished Panel:**

- No inventory costs for connectors, top caps, kick plates and clips.
- Less time required to install, or to disassemble, move and re-install.
- Open bottom panels can reduce cost and improve circulation within the office.

**Fewer Parts:**

- Only 1 universal cantilever and 3 brackets are needed to build most workstations.
- Easy to attach and remove components from panels.

**Simplified Specifications:**

- Fewer parts and components make specifying, ordering, and verifying less work.
- Product fits a 6" planning module.

**Communications Channel:**

- Base communication channel reduces time to install and change cables.
- Warranty:
- Limited Lifetime Warranty on materials and workmanship.

**DIET PANELS - GUIDELINES FOR ORDERING PRODUCT**

**Codes**

The product guide uses a numbering system with meaningful alphanumeric characters to create a simple-to-understand product number. This makes specifying the product much easier and more accurate.

Example of Panel: **DPFRF6636 CHR**

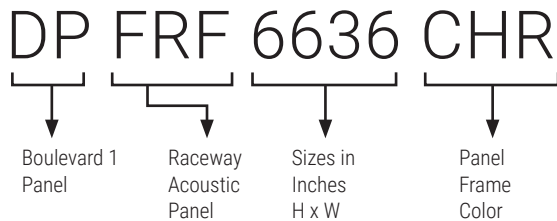

**How to Specify**

Specify Diet Panel type and size by code.  
Specify panel frame finish - ie. CHR (Charcoal).  
Specify all six panel fabric options if necessary.

AN50	Inside Lower Fabric
AN50	Inside Middle Fabric
AN50	Inside Upper Fabric
BE21	Outside Lower Fabric
BE21	Outside Middle Fabric
BE21	Outside Upper Fabric

**DPFF • Fabric Bottom and Fabric Top Panel**

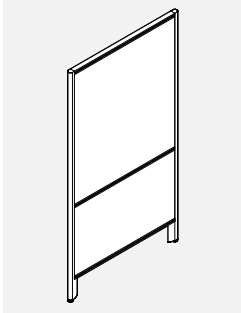

- Fabric above and below the middle rail provides visual privacy.
- Full panel with top, middle and bottom rail.
- OPT\* = Laminate or Whiteboard.
- DPFF Panels do not match standard Boulevard heights of 42" and 54".
- DPFF Panels of 50" and 66" height will match standard Boulevard panel heights.

PRODUCT CODE	PRICE		GROUP OPT*	SIZE/INCHES			WEIGHT VOL	
	1	2		H	W	D	LBS	FT <sup>3</sup>
DPFF4224	362	404	447	42	24	1.3	16	1.32
DPFF4230	382	423	469	42	30	1.3	19	1.62
DPFF4236	405	480	561	42	36	1.3	23	1.94
DPFF4242	426	504	587	42	42	1.3	27	2.24
DPFF4248	447	523	603	42	48	1.3	31	2.55
DPFF4254	471	546	626	42	54	1.3	35	2.85
DPFF4260	490	566	646	42	60	1.3	39	3.16
DPFF5024	452	495	540	50	24	1.3	16	1.62
DPFF5030	476	518	562	50	30	1.3	21	2.08
DPFF5036	498	600	707	50	36	1.3	25	2.47
DPFF5042	524	651	757	50	42	1.3	30	2.85
DPFF5048	550	800	757	50	48	1.3	35	3.25
DPFF5054	574	676	783	50	54	1.3	40	3.63
DPFF5060	599	701	808	50	60	1.3	45	4.02
DPFF5424	452	495	540	54	24	1.3	18	1.62
DPFF5430	476	518	562	54	30	1.3	23	2.08
DPFF5436	498	600	707	54	36	1.3	27	2.47
DPFF5442	524	626	734	54	42	1.3	32	2.85
DPFF5448	550	654	761	54	48	1.3	37	3.25
DPFF5454	574	676	783	54	54	1.3	42	3.63
DPFF5460	599	701	808	54	60	1.3	47	4.02
DPFF6624	492	561	632	66	24	1.3	23	2.04
DPFF6630	520	588	659	66	30	1.3	29	2.52
DPFF6636	549	648	756	66	36	1.3	35	3.00
DPFF6642	576	678	784	66	42	1.3	41	3.46
DPFF6648	601	703	811	66	48	1.3	47	3.93
DPFF6654	628	732	838	66	54	1.3	53	4.40
DPFF6660	657	757	868	66	60	1.3	59	4.90

**BDPFF • Fabric Bottom and Fabric Top Panel to Match Boulevard Panels**

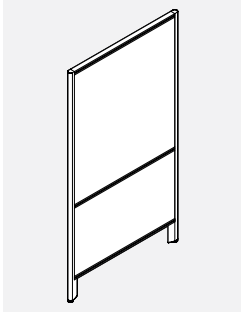

- Fabric above and below the middle rail provides visual privacy.
- Full panel with top, middle and bottom rail.
- OPT\* = Laminate or Whiteboard
- Panels will match corresponding Boulevard Panel heights.

PRODUCT CODE	PRICE		GROUP OPT*	SIZE/INCHES			WEIGHT VOL	
	1	2		H	W	D	LBS	FT <sup>3</sup>
BDPFF4224	362	404	448	42	24	1.3	16	1.32
BDPFF4230	382	423	469	42	30	1.3	19	1.62
BDPFF4236	405	480	561	42	36	1.3	23	1.94
BDPFF4242	426	502	582	42	42	1.3	27	2.24
BDPFF4248	447	523	603	42	48	1.3	31	2.55
BDPFF4254	471	547	627	42	54	1.3	35	2.85
BDPFF4260	490	566	646	42	60	1.3	39	3.16
BDPFF5424	452	493	539	54	24	1.3	18	1.62
BDPFF5430	476	518	563	54	30	1.3	23	2.08
BDPFF5436	498	600	707	54	36	1.3	27	2.47
BDPFF5442	524	626	733	54	42	1.3	32	2.85
BDPFF5448	550	651	757	54	48	1.3	37	3.25
BDPFF5454	574	676	783	54	54	1.3	42	3.63
BDPFF5460	599	701	808	54	60	1.3	47	4.02



**DPOF • Open Bottom and Fabric Top Panel**

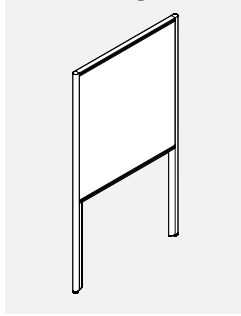

- Fabric above the middle rail provides visual privacy.
- Panel with top and middle rail only.
- Open bottom reduces cost and improves air circulation within the office.
- OPT\* = Laminate or Whiteboard.
- DPOF Panels do not match standard Boulevard heights of 42" and 54".
- DPOF Panels of 50" and 66" height will match standard Boulevard panel heights.

PRODUCT CODE	PRICE		GROUP	OPT*	SIZE/INCHES			WEIGHT VOL	
	1	2			H	W	D	LBS	FT <sup>3</sup>
DPOF4224	238	252	266	42	24	1.3	9	1.32	
DPOF4230	253	264	280	42	30	1.3	12	1.62	
DPOF4236	291	318	342	42	36	1.3	15	1.94	
DPOF4242	308	333	361	42	42	1.3	17	2.24	
DPOF4248	322	345	373	42	48	1.3	19	2.55	
DPOF4254	336	362	387	42	54	1.3	22	2.85	
DPOF4260	350	374	403	42	60	1.3	24	3.16	
DPOF5024	299	323	350	50	24	1.3	10	1.62	
DPOF5030	318	341	368	50	30	1.3	13	2.08	
DPOF5036	378	428	481	50	36	1.3	16	2.47	
DPOF5042	398	449	503	50	42	1.3	19	2.85	
DPOF5048	417	468	520	50	48	1.3	21	3.25	
DPOF5054	435	486	539	50	54	1.3	25	3.63	
DPOF5060	452	503	556	50	60	1.3	28	4.02	
DPOF5424	299	323	350	54	24	1.3	12	1.62	
DPOF5430	318	341	368	54	30	1.3	15	2.08	
DPOF5436	378	428	481	54	36	1.3	18	2.47	
DPOF5442	398	449	503	54	42	1.3	21	2.85	
DPOF5448	417	468	520	54	48	1.3	24	3.25	
DPOF5454	435	486	539	54	54	1.3	27	3.63	
DPOF5460	452	503	556	54	60	1.3	30	4.02	
DPOF6624	365	416	469	66	24	1.3	17	2.04	
DPOF6630	385	438	492	66	30	1.3	21	2.52	
DPOF6636	457	506	558	66	36	1.3	25	3.00	
DPOF6642	497	549	601	66	42	1.3	29	3.46	
DPOF6648	522	572	626	66	48	1.3	33	3.93	
DPOF6654	545	595	647	66	54	1.3	37	4.40	
DPOF6660	566	619	670	66	60	1.3	41	4.90	

**BDPOF • Open Bottom and Fabric Top Panel to Match Boulevard Panels**

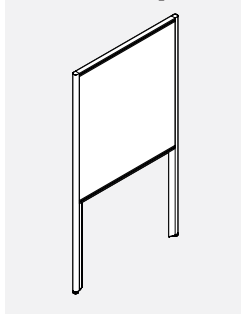

- Fabric above the middle rail provides visual privacy.
- Panel with top and middle rail only.
- Open bottom reduces cost and improves air circulation within the office.
- OPT\* = Laminate or Whiteboard
- Panels will match corresponding Boulevard Panel heights.

PRODUCT CODE	PRICE		GROUP	OPT*	SIZE/INCHES			WEIGHT VOL	
	1	2			H	W	D	LBS	FT <sup>3</sup>
BDPOF4224	238	252	265	42	24	1.3	9	1.32	
BDPOF4230	253	264	279	42	30	1.3	12	1.62	
BDPOF4236	291	317	342	42	36	1.3	15	1.94	
BDPOF4242	308	334	361	42	42	1.3	17	2.24	
BDPOF4248	322	347	374	42	48	1.3	19	2.55	
BDPOF4254	336	362	388	42	54	1.3	22	2.85	
BDPOF4260	350	376	403	42	60	1.3	24	3.16	
BDPOF5424	299	324	351	54	24	1.3	12	1.62	
BDPOF5430	318	342	371	54	30	1.3	15	2.08	
BDPOF5436	378	428	481	54	36	1.3	18	2.47	
BDPOF5442	398	449	503	54	42	1.3	21	2.85	
BDPOF5448	417	468	520	54	48	1.3	24	3.25	
BDPOF5454	435	486	539	54	54	1.3	27	3.63	
BDPOF5460	452	503	556	54	60	1.3	30	4.02	

**DPFRF • Fabric Bottom, Middle and Top Panel**

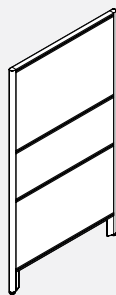

- Fabric above, below and between the middle rails provides visual privacy.
- Full panel with additional rail at 42" high.
- Upper middle rail accepts Teknion Accessories, Monitor Arm Support and Off-Module Shelves.
- OPT\* = Laminate or Whiteboard

PRODUCT CODE	PRICE		GROUP	SIZE / INCHES			WEIGHT VOL	
	1	2		H	W	D	LBS	FT <sup>3</sup>
DPFRF5024	475	517	562	50	24	1.3	16	1.62
DPFRF5030	498	529	558	50	30	1.3	21	2.08
DPFRF5036	525	577	631	50	36	1.3	25	2.47
DPFRF5042	552	617	679	50	42	1.3	30	2.85
DPFRF5048	579	655	740	50	48	1.3	35	3.25
DPFRF5054	601	682	757	50	54	1.3	40	3.63
DPFRF5060	628	717	811	50	60	1.3	45	4.02
DPFRF5424	475	517	561	54	24	1.3	18	1.62
DPFRF5430	498	529	558	54	30	1.3	23	2.08
DPFRF5436	525	577	631	54	36	1.3	27	2.47
DPFRF5442	552	612	679	54	42	1.3	32	2.85
DPFRF5448	581	652	735	54	48	1.3	37	3.25
DPFRF5454	601	679	757	54	54	1.3	42	3.63
DPFRF5460	628	705	786	54	60	1.3	47	4.02
DPFRF6624	518	563	610	66	24	1.3	23	2.04
DPFRF6630	547	593	641	66	30	1.3	29	2.52
DPFRF6636	576	651	732	66	36	1.3	35	3.00
DPFRF6642	604	690	783	66	42	1.3	41	3.46
DPFRF6648	635	719	811	66	48	1.3	47	3.93
DPFRF6654	660	751	849	66	54	1.3	53	4.40
DPFRF6660	689	814	950	66	60	1.3	59	4.90

**DPORF • Open Bottom, Fabric Middle and Top Panel**

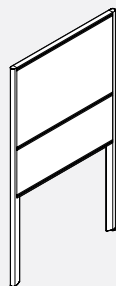

- Fabric above the middle rail provides visual privacy.
- Open bottom panel with additional rail at 42" high.
- Upper middle rail accepts Teknion Accessories, Monitor Arm Support and Off-Module Shelves.
- Open bottom reduces cost and improves air circulation within the office.
- OPT\* = Laminate or Whiteboard

PRODUCT CODE	PRICE		GROUP	SIZE / INCHES			WEIGHT VOL	
	1	2		H	W	D	LBS	FT <sup>3</sup>
DPORF5024	312	339	372	50	24	1.3	10	1.62
DPORF5030	333	362	392	50	30	1.3	13	2.08
DPORF5036	398	426	459	50	36	1.3	16	2.47
DPORF5042	417	454	502	50	42	1.3	19	2.85
DPORF5048	437	475	523	50	48	1.3	21	3.25
DPORF5054	458	498	540	50	54	1.3	25	3.63
DPORF5060	475	518	566	50	60	1.3	28	4.02
DPORF5424	312	341	373	54	24	1.3	12	1.62
DPORF5430	333	357	392	54	30	1.3	15	2.08
DPORF5436	398	430	462	54	36	1.3	18	2.47
DPORF5442	417	458	498	54	42	1.3	21	2.85
DPORF5448	437	477	520	54	48	1.3	24	3.25
DPORF5454	458	501	550	54	54	1.3	27	3.63
DPORF5460	475	519	567	54	60	1.3	30	4.02
DPORF6624	382	422	466	66	24	1.3	17	2.04
DPORF6630	406	446	489	66	30	1.3	21	2.52
DPORF6636	477	544	612	66	36	1.3	25	3.00
DPORF6642	524	595	670	66	42	1.3	29	3.46
DPORF6648	549	616	684	66	48	1.3	33	3.93
DPORF6654	572	642	718	66	54	1.3	37	4.40
DPORF6660	597	662	733	66	60	1.3	41	4.90

**DPFFG • Fabric Bottom, Fabric Middle and Glazed Top Panel**

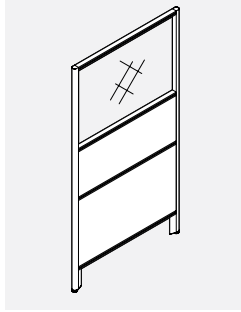

- Fabric below and between the middle rails provides visual privacy.
- Fabric bottom panel with additional rail at 28" high.
- Upper middle rail accepts Teknion Accessories, Monitor Arm Support and Off-Module Shelves.
- Extruded aluminum frame surrounds acrylic glazing at top.
- PVC Extrusion is only Charcoal.
- OPT\* = Laminate or Whiteboard

PRODUCT CODE	PRICE		GROUP	OPT*	SIZE/INCHES			WEIGHT VOL	
	1	2			H	W	D	LBS	FT <sup>3</sup>
DPFFG5024	479	509	539	50	24	1.3	12	1.62	
DPFFG5030	524	554	583	50	30	1.3	15	2.08	
DPFFG5036	571	628	698	50	36	1.3	18	2.47	
DPFFG5042	619	678	746	50	42	1.3	21	2.85	
DPFFG5048	662	722	790	50	48	1.3	24	3.25	
DPFFG5054	709	768	838	50	54	1.3	27	3.63	
DPFFG5060	768	829	897	50	60	1.3	30	4.02	
DPFFG5424	479	509	539	54	24	1.3	17	1.62	
DPFFG5430	524	555	587	54	30	1.3	21	2.08	
DPFFG5436	571	635	702	54	36	1.3	25	2.47	
DPFFG5442	619	680	748	54	42	1.3	29	2.85	
DPFFG5448	662	724	792	54	48	1.3	33	3.25	
DPFFG5454	709	775	842	54	54	1.3	37	3.63	
DPFFG5460	768	831	900	54	60	1.3	41	4.02	
DPFFG6624	567	620	671	66	24	1.3	20	2.04	
DPFFG6630	632	682	736	66	30	1.3	25	2.52	
DPFFG6636	693	757	829	66	36	1.3	30	3.00	
DPFFG6642	754	820	892	66	42	1.3	35	3.46	
DPFFG6648	819	885	955	66	48	1.3	40	3.93	
DPFFG6654	879	944	1014	66	54	1.3	45	4.40	
DPFFG6660	959	1035	1115	66	60	1.3	50	4.90	

**DPOFG • Open Bottom, Fabric Middle and Glazed Top Panel**

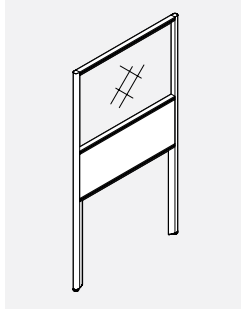

- Fabric between the middle rails.
- Open bottom panel with additional rail at 42" high.
- Upper middle rail accepts Teknion Accessories, Monitor Arm Support and Off-Module Shelves.
- Extruded aluminum frame surrounds acrylic glazing at top.
- PVC Extrusion is only Charcoal.
- OPT\* = Laminate or Whiteboard

PRODUCT CODE	PRICE		GROUP	OPT*	SIZE/INCHES			WEIGHT VOL	
	1	2			H	W	D	LBS	FT <sup>3</sup>
DPOFG5024	377	387	401	50	24	1.3	14	1.62	
DPOFG5030	411	425	437	50	30	1.3	17	2.08	
DPOFG5036	446	458	470	50	36	1.3	20	2.47	
DPOFG5042	482	493	508	50	42	1.3	24	2.85	
DPOFG5048	518	529	541	50	48	1.3	27	3.25	
DPOFG5054	554	578	604	50	54	1.3	30	3.63	
DPOFG5060	597	621	647	50	60	1.3	34	4.02	
DPOFG5424	377	387	401	54	24	1.3	14	1.62	
DPOFG5430	411	425	437	54	30	1.3	17	2.08	
DPOFG5436	446	458	470	54	36	1.3	20	2.47	
DPOFG5442	482	493	508	54	42	1.3	24	2.85	
DPOFG5448	518	529	541	54	48	1.3	27	3.25	
DPOFG5454	554	578	604	54	54	1.3	30	3.63	
DPOFG5460	597	621	647	54	60	1.3	34	4.02	
DPOFG6624	473	482	497	66	24	1.3	17	2.04	
DPOFG6630	522	534	549	66	30	1.3	21	2.52	
DPOFG6636	576	600	627	66	36	1.3	25	3.00	
DPOFG6642	619	642	669	66	42	1.3	29	3.46	
DPOFG6648	665	692	718	66	48	1.3	33	3.93	
DPOFG6654	722	748	775	66	54	1.3	37	4.40	
DPOFG6660	782	806	832	66	60	1.3	41	4.90	

**DPFG • Fabric Bottom and Glazed Top Panel**

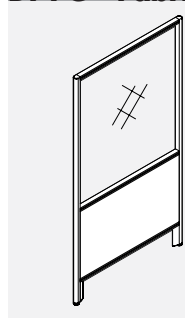

- Fabric between the middle rails.
- Open bottom panel with additional rail at 42" high.
- Upper middle rail accepts Teknion Accessories, Monitor Arm Support and Off-Module Shelves.
- Open bottom reduces cost and improves air circulation within the office.
- Extruded aluminum frame surrounds acrylic glazing at top.
- PVC Extrusion is only Charcoal.
- OPT\* = Laminate or Whiteboard

PRODUCT CODE	PRICE			SIZE/INCHES			WEIGHT VOL	
	1	2	OPT*	H	W	D	LBS	FT <sup>3</sup>
DPFG4224	627	643	659	42	24	1.3	11	1.32
DPFG4230	679	693	709	42	30	1.3	14	1.62
DPFG4236	723	739	754	42	36	1.3	16	1.94
DPFG4242	771	822	875	42	42	1.3	18	2.24
DPFG4248	817	869	922	42	48	1.3	21	2.55
DPFG4254	865	916	968	42	54	1.3	23	2.85
DPFG4260	912	962	1015	42	60	1.3	26	3.16
DPFG5024	627	643	659	50	24	1.3	12	1.62
DPFG5030	679	693	709	50	30	1.3	15	2.08
DPFG5036	723	739	754	50	36	1.3	18	2.47
DPFG5042	771	822	875	50	42	1.3	21	2.85
DPFG5048	817	869	922	50	48	1.3	24	3.25
DPFG5054	865	916	968	50	54	1.3	27	3.63
DPFG5060	912	962	1015	50	60	1.3	29	4.02
DPFG5424	627	643	659	54	24	1.3	13	1.62
DPFG5430	679	693	709	54	30	1.3	16	2.08
DPFG5436	723	739	754	54	36	1.3	20	2.47
DPFG5442	771	822	875	54	42	1.3	23	2.85
DPFG5448	817	869	922	54	48	1.3	26	3.25
DPFG5454	865	916	968	54	54	1.3	29	3.63
DPFG5460	912	962	1015	54	60	1.3	32	4.02
DPFG6624	682	700	717	66	24	1.3	17	2.04
DPFG6630	734	749	767	66	30	1.3	21	2.52
DPFG6636	784	833	889	66	36	1.3	24	3.00
DPFG6642	832	884	939	66	42	1.3	28	3.46
DPFG6648	883	932	986	66	48	1.3	32	3.93
DPFG6654	935	983	1037	66	54	1.3	36	4.40
DPFG6660	988	1037	1091	66	60	1.3	40	4.90

**DPFS • Fabric Bottom, Slat Top Panel**

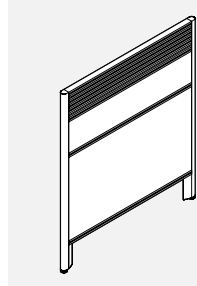

- Integrated 6" slat rail provides flexibility of use.
- Panel integrated slat rail accepts Teknion Accessories, Monitor Arm Support, Off-Module Shelves, Task Light Bracket and Power Bar.
- OPT\* = Laminate or Whiteboard

PRODUCT CODE	PRICE			SIZE/INCHES			WEIGHT VOL	
	1	2	OPT*	H	W	D	LBS	FT <sup>3</sup>
DPFS4224	371	393	419	42	24	1.3	19	1.32
DPFS4230	452	476	501	42	30	1.3	23	1.62
DPFS4236	504	566	636	42	36	1.3	28	1.94
DPFS4242	549	616	682	42	42	1.3	33	2.24
DPFS4248	594	657	724	42	48	1.3	37	2.55
DPFS4254	641	703	772	42	54	1.3	42	2.85
DPFS4260	685	748	816	42	60	1.3	47	3.16

**DPFSF • Fabric Bottom, Slat Middle and Fabric Top Panel**

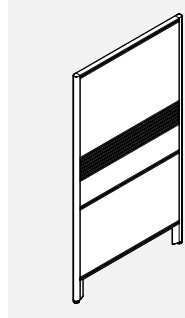

- Integrated 6" slat rail between the middle rails provides flexibility of use. Fabric at the top provides visual privacy.
- Panel integrated slat rail accepts Teknion Accessories, Monitor Arm Support, Off-Module Shelves, Task Light Bracket and Power Bar.
- OPT\* = Laminate or Whiteboard

PRODUCT CODE	PRICE			SIZE/INCHES			WEIGHT VOL	
	1	2	OPT*	H	W	D	LBS	FT <sup>3</sup>
DPFSF5024	517	539	563	50	24	1.3	21	1.62
DPFSF5030	571	593	617	50	30	1.3	28	2.08
DPFSF5036	627	690	757	50	36	1.3	34	2.47
DPFSF5042	682	745	813	50	42	1.3	40	2.85
DPFSF5048	736	799	813	50	48	1.3	46	3.25
DPFSF5054	789	852	919	50	54	1.3	52	3.63
DPFSF5060	842	905	972	50	60	1.3	58	4.02
DPFSF5424	517	539	563	54	24	1.3	23	1.62
DPFSF5430	571	593	617	54	30	1.3	30	2.08
DPFSF5436	627	690	757	54	36	1.3	36	2.47
DPFSF5442	682	745	813	54	42	1.3	42	2.85
DPFSF5448	736	799	813	54	48	1.3	48	3.25
DPFSF5454	789	852	919	54	54	1.3	54	3.63
DPFSF5460	842	905	972	54	60	1.3	60	4.02
DPFSF6624	592	635	679	66	24	1.3	28	2.04
DPFSF6630	652	693	739	66	30	1.3	35	2.52
DPFSF6636	714	817	923	66	36	1.3	42	3.00
DPFSF6642	771	870	978	66	42	1.3	49	3.46
DPFSF6648	831	932	1038	66	48	1.3	56	3.93
DPFSF6654	889	989	1096	66	54	1.3	63	4.40
DPFSF6660	943	1045	1151	66	60	1.3	70	4.90

**DPOSF • Open Bottom, Slat Middle Panel**

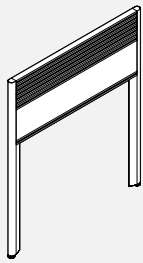

- Integrated 6" slat rail between the middle rails provides flexibility of use.
- Panel integrated slat rail accepts Teknion Accessories, Monitor Arm Support, Off-Module Shelves, Task Light Bracket and Power Bar.
- OPT\* = Laminate or Whiteboard

PRODUCT CODE	PRICE		GROUP OPT*	SIZE/INCHES			WEIGHT VOL	
	1	2		H	W	D	LBS	FT <sup>3</sup>
DPOSF4224	334	340	345	42	24	1.3	12	1.32
DPOSF4230	372	378	383	42	30	1.3	17	1.62
DPOSF4236	410	422	437	42	36	1.3	24	1.94
DPOSF4242	447	460	475	42	42	1.3	28	2.24
DPOSF4248	489	501	517	42	48	1.3	36	2.55
DPOSF4254	525	540	554	42	54	1.3	40	2.85
DPOSF4260	563	576	590	42	60	1.3	44	3.16

**DPOSF • Open Bottom, Slat Middle and Fabric Top Panel**

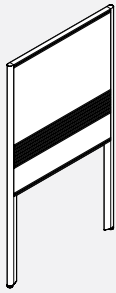

- Integrated 6" slat rail between the middle rails provides flexibility of use. Fabric above middle rail provides privacy.
- Panel integrated slat rail accepts Teknion Accessories, Monitor Arm Support, Off-Module Shelves, Task Light Bracket and Power Bar.
- Open bottom reduces cost and improves air circulation within the office.
- OPT\* = Laminate or Whiteboard

PRODUCT CODE	PRICE		GROUP OPT*	SIZE/INCHES			WEIGHT VOL	
	1	2		H	W	D	LBS	FT <sup>3</sup>
DPOSF5024	441	459	479	50	24	1.3	13	1.62
DPOSF5030	490	512	529	50	30	1.3	14	2.08
DPOSF5036	536	574	610	50	36	1.3	21	2.47
DPOSF5042	583	621	658	50	42	1.3	25	2.85
DPOSF5048	628	665	703	50	48	1.3	29	3.25
DPOSF5054	679	714	752	50	54	1.3	31	3.63
DPOSF5060	723	759	797	50	60	1.3	35	4.02
DPOSF5424	441	459	479	54	24	1.3	15	1.62
DPOSF5430	490	512	529	54	30	1.3	19	2.08
DPOSF5436	536	574	610	54	36	1.3	23	2.47
DPOSF5442	583	621	658	54	42	1.3	27	2.85
DPOSF5448	628	665	703	54	48	1.3	31	3.25
DPOSF5454	679	714	752	54	54	1.3	34	3.63
DPOSF5460	723	759	797	54	60	1.3	38	4.02
DPOSF6624	520	552	587	66	24	1.3	18	2.04
DPOSF6630	572	603	638	66	30	1.3	23	2.52
DPOSF6636	622	684	751	66	36	1.3	28	3.00
DPOSF6642	671	735	804	66	42	1.3	33	3.46
DPOSF6648	724	802	884	66	48	1.3	38	3.93
DPOSF6654	775	851	929	66	54	1.3	43	4.40
DPOSF6660	824	900	979	66	60	1.3	47	4.90

**DPOSG • Open Bottom, Slat Middle and Glazed Top Panel**

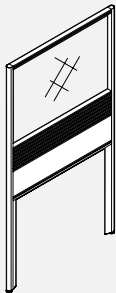

- Integrated 6" slat rail between the middle rails provides flexibility of use.
- Panel integrated slat rail accepts Teknion Accessories, Monitor Arm Support, Off-Module Shelves, Task Light Bracket and Power Bar.
- Open bottom reduces cost and improves air circulation within the office.
- Extruded aluminum frame surrounds acrylic glazing at top.
- PVC Extrusion is only Charcoal.
- OPT\* = Laminate or Whiteboard

PRODUCT CODE	PRICE		GROUP OPT*	SIZE/INCHES			WEIGHT VOL	
	1	2		H	W	D	LBS	FT <sup>3</sup>
DPOSG5024	659	664	670	50	24	1.3	12	1.62
DPOSG5030	709	714	722	50	30	1.3	15	2.08
DPOSG5036	757	770	786	50	36	1.3	18	2.47
DPOSG5042	810	820	835	50	42	1.3	22	2.85
DPOSG5048	859	870	884	50	48	1.3	25	3.25
DPOSG5054	907	917	932	50	54	1.3	28	3.63
DPOSG5060	959	968	982	50	60	1.3	32	4.02
DPOSG5424	659	664	670	54	24	1.3	14	1.62
DPOSG5430	709	714	722	54	30	1.3	17	2.08
DPOSG5436	757	770	786	54	36	1.3	20	2.47
DPOSG5442	810	820	835	54	42	1.3	24	2.85
DPOSG5448	859	870	884	54	48	1.3	27	3.25
DPOSG5454	907	917	932	54	54	1.3	30	3.63
DPOSG5460	959	968	982	54	60	1.3	34	4.02
DPOSG6624	717	723	729	66	24	1.3	17	2.04
DPOSG6630	768	776	782	66	30	1.3	21	2.52
DPOSG6636	822	833	851	66	36	1.3	25	3.00
DPOSG6642	871	884	898	66	42	1.3	29	3.46
DPOSG6648	928	940	955	66	48	1.3	33	3.93
DPOSG6654	978	992	1005	66	54	1.3	37	4.40
DPOSG6660	1036	1049	1064	66	60	1.3	41	4.90

**DPFSG • Fabric Bottom, Slat Middle and Glazed Top Panel**

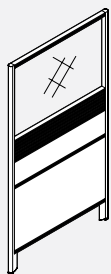

- Integrated 6" slat rail provides flexibility of use.
- Panel integrated slat rail accepts Teknion Accessories, Monitor Arm Support, Off-Module Shelves, Task Light Bracket and Power Bar.
- Extruded aluminum frame surrounds acrylic glazing at top.
- PVC Extrusion is only Charcoal.
- OPT\* = Laminate or Whiteboard

PRODUCT CODE	PRICE		GROUP	OPT*	SIZE/INCHES			WEIGHT VOL	
	1	2			H	W	D	LBS	FT <sup>3</sup>
DPFSG5024	723	744	765	50	24	1.3	15	1.62	
DPFSG5030	781	800	829	50	30	1.3	19	2.08	
DPFSG5036	832	895	960	50	36	1.3	23	2.47	
DPFSG5042	889	949	1016	50	42	1.3	27	2.85	
DPFSG5048	940	999	1068	50	48	1.3	31	3.25	
DPFSG5054	995	1053	1123	50	54	1.3	35	3.63	
DPFSG5060	1049	1108	1177	50	60	1.3	39	4.02	
DPFSG5424	723	744	765	54	24	1.3	17	1.62	
DPFSG5430	781	800	829	54	30	1.3	21	2.08	
DPFSG5436	832	895	960	54	36	1.3	25	2.47	
DPFSG5442	889	949	1016	54	42	1.3	29	2.85	
DPFSG5448	940	999	1068	54	48	1.3	33	3.25	
DPFSG5454	995	1053	1123	54	54	1.3	37	3.63	
DPFSG5460	1049	1108	1177	54	60	1.3	41	4.02	
DPFSG6624	786	808	832	66	24	1.3	20	2.04	
DPFSG6630	842	863	891	66	30	1.3	25	2.52	
DPFSG6636	900	962	1030	66	36	1.3	30	3.00	
DPFSG6642	959	1021	1090	66	42	1.3	35	3.46	
DPFSG6648	1015	1080	1149	66	48	1.3	40	3.93	
DPFSG6654	1072	1135	1203	66	54	1.3	45	4.40	
DPFSG6660	1133	1194	1264	66	60	1.3	50	4.90	

**DPOPF • Diet Over Panel**

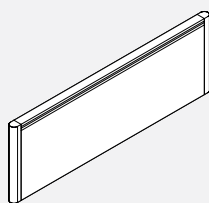

- Over Panels attach to regular Diet Panels to provide additional visual privacy.
- Over Panel is secured to regular Diet Panels with 4 brackets and set screws.
- Accessory loading capabilities only.
- Not for use with overhead storage.
- OPT\* = Laminate or Whiteboard

PRODUCT CODE	PRICE		GROUP	OPT*	SIZE/INCHES			WEIGHT VOL	
	1	2			H	W	D	LBS	FT <sup>3</sup>
DPOPF1224	196	207	221	12	24	1.3	5	0.30	
DPOPF1230	221	233	249	12	30	1.3	7	0.60	
DPOPF1236	252	276	303	12	36	1.3	8	0.75	
DPOPF1242	275	302	331	12	42	1.3	9	0.88	
DPOPF1248	303	329	356	12	48	1.3	11	1.00	
DPOPF1254	333	360	384	12	54	1.3	12	1.13	
DPOPF1260	352	378	405	12	60	1.3	13	1.25	
DPOPF2424	272	299	326	24	24	1.3	10	1.00	
DPOPF2430	295	319	345	24	30	1.3	14	1.25	
DPOPF2436	314	352	393	24	36	1.3	16	1.45	
DPOPF2442	336	374	416	24	42	1.3	18	1.75	
DPOPF2448	357	394	436	24	48	1.3	22	2.00	
DPOPF2454	378	416	458	24	54	1.3	24	2.25	
DPOPF2460	403	438	480	24	60	1.3	26	2.50	

**DTMPP • Table-Mounted Diet Panels**

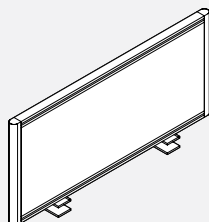

- Creates privacy and flexibility at the end of worksurfaces.
- Side Panels for sides of worksurfaces available 24", and 36" widths (nominal width).
- Back Panels for sides of tables available 48", 54" and 60" widths.
- Attaches with similar clamp to other clamp on accessories.
- Non tackable, non load-bearing, no hang on capabilities and not for use with transaction tops.
- Not for use with Licence product due to interference of gables and flush modesties.
- OPT\* = Laminate or Whiteboard

PRODUCT CODE	PRICE		GROUP	OPT*	SIZE/INCHES			WEIGHT VOL	
	1	2			H	W	D	LBS	FT <sup>3</sup>
<b>SIDE PANELS</b>									
DTMPP24	214	226	242	16.5	21	1.3	7	0.75	
DTMPP30	230	244	258	16.5	27	1.3	8	0.94	
DTMPP36	249	272	301	16.5	33	1.3	10	1.13	
<b>BACK PANELS</b>									
DTMPP48	275	301	328	16.5	48	1.3	15	1.53	
DTMPP54	301	326	352	16.5	54	1.3	17	1.72	
DTMPP60	324	350	377	16.5	60	1.3	18	1.91	

**DPCBM • Panel Cable Manager**

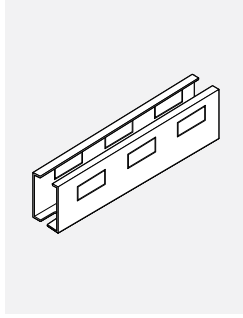

- Provides wire management for the Diet Panels.
- Extruded, dual durometer "U" channel organizes cables below panels.
- Snaps into bottom rail and into mid rail on open bottom panels.
- One data partial knock-out (2.67" wide x 1.36" high) provided on either side of the Raceway Cover accommodates terminal plates from various vendors.
- Panel Cable Manager comes in charcoal only.

PRODUCT CODE	PRICE	SIZE/INCHES			WEIGHT VOL	
		H	W	D	LBS	FT <sup>3</sup>
DPCBM24	11	4	18	1.3	1.3	0.07
DPCBM30	14	4	24	1.3	1.4	0.08
DPCBM36	25	4	30	1.3	1.5	0.10
DPCBM42	28	4	36	1.3	1.6	0.13
DPCBM48	31	4	42	1.3	1.7	0.15
DPCBM54	33	4	48	1.3	1.8	0.16
DPCBM60	36	4	54	1.3	1.9	0.19

**DPOFM • Off-Module Panel Connector**

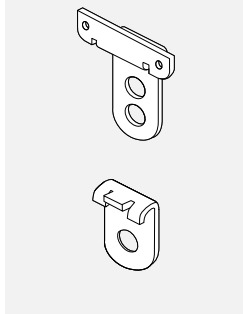

- Connects two perpendicular Diet Panels Off-Module.
- Top and bottom brackets bolt to Diet Panel verticals and engage to top and bottom rails of adjacent, perpendicular panel of even or lower height.
- Connectors can also be used to connect a panel in the middle of perpendicular DPFRF, DPORF, DPFFG, DPFSG and DPFSF at their 42" height secondary middle rail.
- Top and bottom brackets fit in place of standard hinge connectors.
- All fasteners included.

PRODUCT CODE	PRICE	SIZE/INCHES			WEIGHT VOL	
		H	W	D	LBS	FT <sup>3</sup>
DPOFM	42	4	3	2	1	0.08

**DPPWA • Wall Adapter**

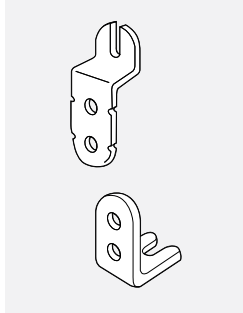

- Connects Diet Panels to walls.
- Bolts to Diet Panel vertical in place of the standard hinge connectors.
- Keyhole openings in Diet adapter slide over fasteners pre-installed to the wall.
- All fasteners included, however, the mounting hardware to affix adapter to wall not included, they will be based on type of wall material.

PRODUCT CODE	PRICE	SIZE/INCHES			WEIGHT VOL	
		H	W	D	LBS	FT <sup>3</sup>
DPPWA	42	40	2.5		1	0.08

**DPCSTR • Casters**

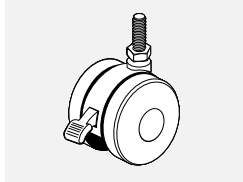

- Changes a freestanding Diet Panel to mobile.
- Must be used on two panels or more.
- Order 1 caster more than the number of panels. (Using only 1 caster where panels connect.) For example, 3 panels, 4 casters or 2 panels, 3 casters.
- Casters raise Diet Panels by a height of 1.1".

PRODUCT CODE	PRICE	SIZE/INCHES			WEIGHT VOL	
		H	W	D	LBS	FT <sup>3</sup>
DPCSTR	9	1.5	1.5	1.5	.25	1.02

**DPLTSBKIT • Telescopic Sliding Kit**

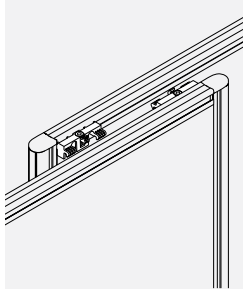

- Diet Telescopic Sliding Kit flexibly connects two standard parallel Diet panels and forms a length-adjustable partition.
- Kit consists of two top and two bottom sliding box assemblies and all the necessary connecting hardware.
- Made of black injection molded resin.
- The panels must be of the same height and equipped with top and bottom standard Diet extrusions.
- The kit can be installed as right or left on site, determining the direction of nesting/sliding.
- The kit offsets the parallel panel and the resulting gap is 12.5mm (½")
- Up to three standard Diet panels can be connected to form the length-adjustable partition.
- The kit is not intended to be used in place of a sliding door.
- The kit cannot be used with Diet overpanels or Diet Linking Panels.

PRODUCT CODE	PRICE	SIZE/INCHES			WEIGHT VOL	
		H	W	D	LBS	FT <sup>3</sup>
DPLTSBKIT	106	0.75	3	0.5	0.04	0.15

**DBSCB • Diet to Boulevard Slot Connector**

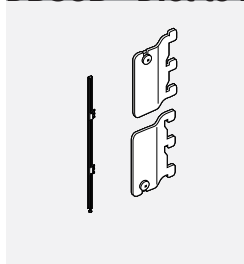

- Connects a Diet Panel to a Boulevard Panel via slots eliminating the need for the Boulevard Post and reducing the overall length and cost of a panel run.
- Connector can be installed in left or right configuration.
- Comes as a pair (Upper and lower brackets).
- Worksurfaces should be ordered based on application keeping in mind that this connector will align to the left or right of the end of the Boulevard Panel.
- Application drawings and layout must be provided for specials.

PRODUCT CODE	PRICE	SIZE/INCHES			WEIGHT VOL	
		H	W	D	LBS	FT <sup>3</sup>
DBSCB02	49	3	0.5	00.0	1	0.05

**DAPPF • Diet Gap Filler**

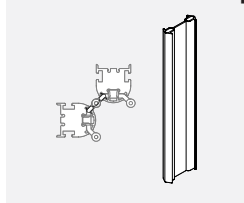

- Closes the gap between panels.
- Must be used on two or more panels.
- Order 1 DAPPF36 for a 42" high panel, 1 DAPPF36 and 1 DAPPF12 for a 54" high panel, or 1 DAPPF36 and 2 DAPPF12 for 66" high panel.

PRODUCT CODE	PRICE	SIZE/INCHES			WEIGHT VOL	
		H	W	D	LBS	FT <sup>3</sup>
DAPPF12	7	11.5	00.0	00.0	000	000
DAPPF36	17	36.33	00.0	00.0	000	000

**DHFFA • Single Flat Foot**

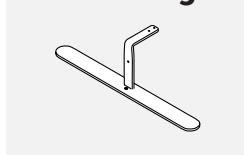

- Used to create a freestanding panel
- Foot is flat to the floor with no adjustable glides
- No load capabilities on freestanding panel
- Only for use with Fabric Bottom panels
- Can be used to retrofit existing Diet panels on site
- Not for use with Diet Linking Panels
- Specify standard panel frame paint finishes

PRODUCT CODE	PRICE	SIZE/INCHES			WEIGHT VOL	
		H	W	D	LBS	FT <sup>3</sup>
DHFFA	133	6	20	2	3.48	0.15

**DHFFA02 • Flat Foot Kit**

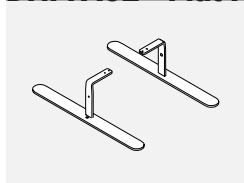

- Used to create a freestanding panel
- Feet are flat to the floor with no adjustable glides
- No load capabilities on freestanding panel
- Cannot be used with open bottom panels or Linking Panels.
- Can be used to retrofit existing Diet panels on site
- Not for use with Diet Linking Panels
- Specify standard panel frame paint finishes

PRODUCT CODE	PRICE	SIZE/INCHES			WEIGHT VOL	
		H	W	D	LBS	FT <sup>3</sup>
DHFFA02	265	6	20	2	7	0.3

**DHCFAN • Single Caster Foot**



- Used to create a mobile panel
- Casters are locking
- No load capabilities on mobile panel
- Only for use with Fabric Bottom panels
- Can be used to retrofit existing Diet panels on site
- Not for use with Diet Linking Panels
- Specify standard panel frame paint finishes

PRODUCT CODE	PRICE	SIZE/INCHES			WEIGHT VOL	
		H	W	D	LBS	FT <sup>3</sup>
DHCFAN	176	6	20	2	3.87	0.15

**DHCFAN02 • Caster Foot Kit**

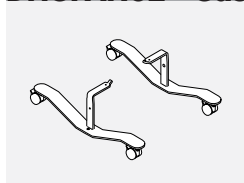

- Used to create a mobile panel
- Casters are locking
- No load capabilities on mobile panel
- Only for use with Fabric Bottom panels
- Can be used to retrofit existing Diet panels on site
- Not for use with Diet Linking Panels
- Specify standard panel frame paint finishes

PRODUCT CODE	PRICE	SIZE/INCHES			WEIGHT VOL	
		H	W	D	LBS	FT <sup>3</sup>
DHCFAN02	350	6	20	2	7.7	0.3

**DHCFAL01 • Diet Caster Assembly Kit**

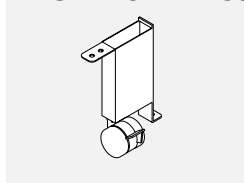

- To be used on one side to create a mobile panel with DHCFAN on the other side.
- Caster is locking.
- No load capabilities on mobile panel
- Only for use with Fabric Bottom panels.
- Can be used to retrofit existing Diet panels on site.
- Not for use with Diet Linking Panels.
- Specify standard panel frame paint finishes.

PRODUCT CODE	PRICE	SIZE/INCHES			WEIGHT VOL	
		H	W	D	LBS	FT <sup>3</sup>
DHCFAL01	72	6	1	4.8	1	0.02



**DB-P-X • Diet to Boulevard Slim Connector in “X” Configuration**

- Creates a perpendicular connection between Diet Panel and Boulevard Panel that eliminates the need for special sized worksurfaces.
- Note: For use with new BDPFFxxxx & BDPOFxxxx panels.

**Diet to Boulevard 1 “X” Configuration**

PRODUCT CODE	PRICE	B1 HEIGHT	DIET PANEL HEIGHT	SIZE/INCHES			WEIGHT VOL	
				H	W	D	LBS	FT <sup>3</sup>
BDB1P4242X	123	42"	42"	42	1.3	2.6	4	0.207
BDB1P4250X	139	50"	42"	50	1.3	2.6	5	0.245
BDB1P4254X	153	54"	42"	54	1.3	2.6	5	0.264
BDB1P4258X	153	58"	42"	58	1.3	2.6	6	0.283
BDB1P4266X	166	66"	42"	66	1.3	2.6	7	0.322
BDB1P4274X	179	74"	42"	74	1.3	2.6	8	0.360
BDB1P4282X	196	82"	42"	82	1.3	2.6	9	0.399
BDB1P5050X	139	50"	50"	50	1.3	2.6	5	0.245
BDB1P5054X	153	54"	50"	54	1.3	2.6	5	0.264
BDB1P5058X	153	58"	50"	58	1.3	2.6	6	0.283
BDB1P5066X	166	66"	50"	66	1.3	2.6	7	0.322
BDB1P5074X	179	74"	50"	74	1.3	2.6	8	0.360
BDB1P5082X	196	82"	50"	82	1.3	2.6	9	0.399
BDB1P5454X	153	54"	54"	54	1.3	2.6	5	0.264
BDB1P5458X	153	58"	54"	58	1.3	2.6	6	0.283
BDB1P5466X	166	66"	54"	66	1.3	2.6	7	0.322
BDB1P5474X	179	74"	54"	74	1.3	2.6	8	0.360
BDB1P5482X	196	82"	54"	82	1.3	2.6	9	0.399
BDB1P6666X	166	66"	66"	66	1.3	2.6	7	0.322
BDB1P6674X	179	74"	66"	74	1.3	2.6	8	0.360
BDB1P6682X	196	82"	66"	82	1.3	2.6	9	0.399

**Diet to System 3 “X” Configuration**

PRODUCT CODE	PRICE	SYSTEM 3 HEIGHT	DIET PANEL HEIGHT	SIZE/INCHES			WEIGHT VOL	
				H	W	D	LBS	FT <sup>3</sup>
BDB3P4242X	123	42"	42"	42	1.3	2.6	4	0.207
BDB3P4250X	139	50"	42"	50	1.3	2.6	5	0.245
BDB3P4254X	153	54"	42"	54	1.3	2.6	6	0.260
BDB3P4266X	166	66"	42"	66	1.3	2.6	7	0.322
BDB3P5050X	166	50"	50"	50	1.3	2.6	5	0.245
BDB3P5054X	153	54"	50"	54	1.3	2.6	6	0.260
BDB3P5066X	166	66"	50"	66	1.3	2.6	7	0.322
BDB3P5454X	153	54"	54"	54	1.3	2.6	6	0.260
BDB3P5466X	166	66"	54"	66	1.3	2.6	7	0.322
BDB3P6666X	166	66"	66"	66	1.3	2.6	7	0.322

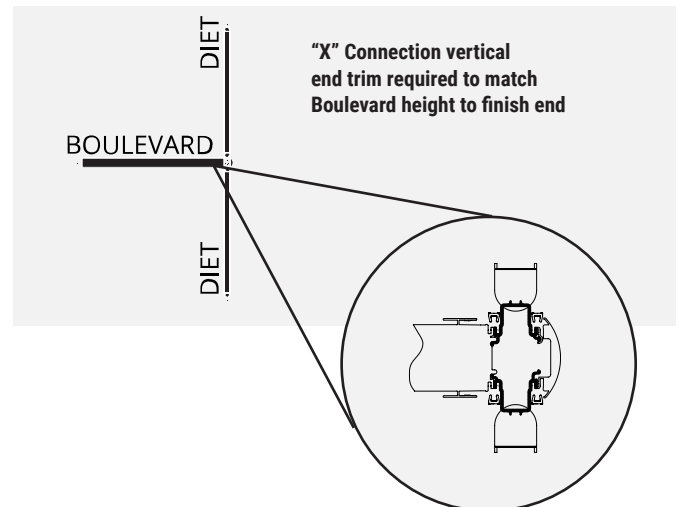
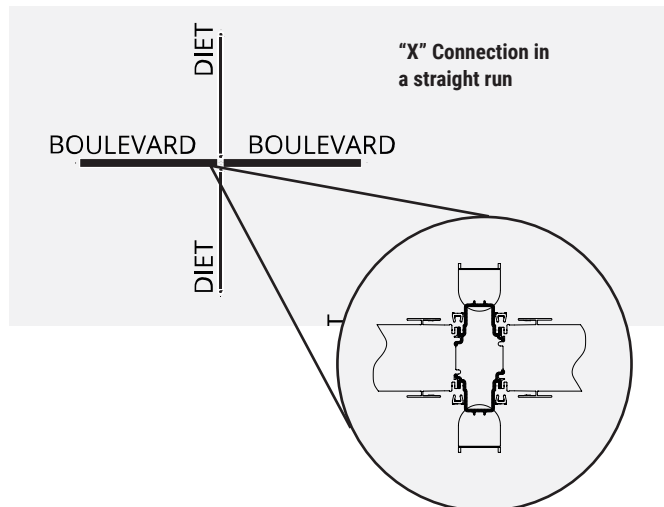

\* Please specify separate end trim (round or flat) to close end.

**DBXP-T • Diet to Boulevard Slim Connector in "T" Configuration**

- Creates a perpendicular connection between Diet Panel and Boulevard Panel that eliminates the need for special sized worksurfaces.
- Note: For use with new BDPFFxxxx & BDPOFxxxx panels.

**Diet to Boulevard 1 "T" Configuration**

PRODUCT CODE	PRICE	B1 HEIGHT	DIET PANEL HEIGHT	SIZE/INCHES			WEIGHT VOL	
				H	W	D	LBS	FT <sup>3</sup>
BDB1P4242T	123	42"	42"	42	1.3	2.6	4	0.207
BDB1P4250T	139	50"	42"	50	1.3	2.6	5	0.245
BDB1P4254T	141	54"	42"	54	1.3	2.6	5	0.264
BDB1P4258T	153	58"	42"	58	1.3	2.6	6	0.283
BDB1P4266T	166	66"	42"	66	1.6	2.6	7	0.322
BDB1P4274T	179	74"	42"	74	1.3	2.6	8	0.36
BDB1P4282T	196	82"	42"	82	1.3	2.6	9	0.399
BDB1P5050T	139	50"	50"	50	1.3	2.6	5	0.245
BDB1P5054T	153	54"	50"	54	1.3	2.6	5	0.264
BDB1P5058T	153	58"	50"	58	1.3	2.6	6	0.283
BDB1P5066T	153	66"	50"	66	1.3	2.6	7	0.322
BDB1P5074T	179	74"	50"	74	1.3	2.6	8	0.360
BDB1P5082T	196	82"	50"	82	1.3	2.6	9	0.399
BDB1P5454T	153	54"	54"	54	1.3	2.6	6	0.245
BDB1P5458T	153	58"	54"	58	1.3	2.6	6	0.283
BDB1P5466T	166	66"	54"	66	1.3	2.6	7	0.322
BDB1P5474T	179	74"	54"	74	1.3	2.6	8	0.360
BDB1P5482T	196	82"	54"	82	1.3	2.6	9	0.399
BDB1P6666T	166	66"	66"	66	1.3	2.6	7	0.322
BDB1P6674T	179	74"	66"	74	1.3	2.6	8	0.360
BDB1P6682T	196	82"	66"	82	1.3	2.6	9	0.399

**Diet to System 3 "T" Configuration**

PRODUCT CODE	PRICE	SYSTEM 3 HEIGHT	DIET PANEL HEIGHT	SIZE/INCHES			WEIGHT VOL	
				H	W	D	LBS	FT <sup>3</sup>
BDB3P4242T	123	42"	42"	42	1.3	2.6	4	0.207
BDB3P4250T	139	50"	42"	50	1.3	2.6	5	0.245
BDB3P4254T	153	54"	42"	54	1.3	2.6	6	0.245
BDB3P4266T	166	66"	42"	66	1.3	2.6	7	0.322
BDB3P5050T	166	50"	50"	50	1.3	2.6	5	0.245
BDB3P5054T	141	54"	50"	54	1.3	2.6	6	0.245
BDB3P5066T	162	66"	50"	66	1.3	2.6	7	0.322
BDB3P5454T	149	54"	54"	54	1.3	2.6	6	0.245
BDB3P5466T	166	66"	54"	66	1.3	2.6	7	0.322
BDB3P6666T	166	66"	66"	66	1.3	2.6	7	0.322

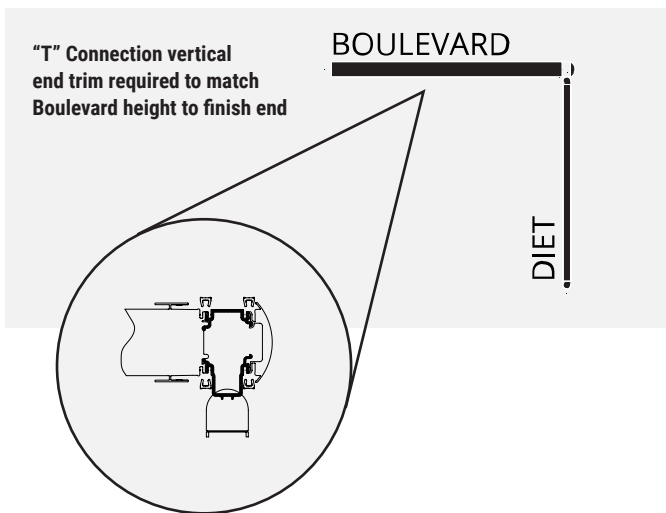
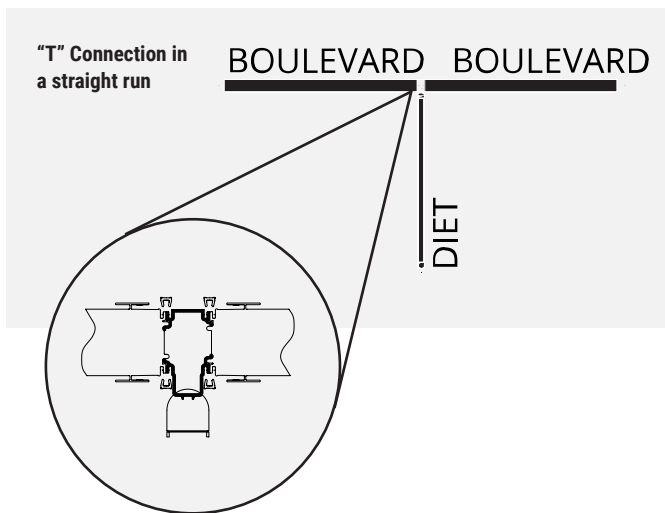

\* Please specify separate end trim (round or flat) to close end.

**DB-P-X • Diet to Boulevard Slim Connector in "X" Configuration**

- Creates a perpendicular connection between Diet Panel and Boulevard Panel that eliminates the need for special sized worksurfaces.
- Note: For use with regular DPxxxx panels.

**Diet to Boulevard 1 "X" Configuration**

PRODUCT CODE	PRICE	B1 HEIGHT	DIET PANEL HEIGHT	SIZE/INCHES			WEIGHT VOL	
				H	W	D	LBS	FT <sup>3</sup>
DB1P4242X	123	42"	42"	42	1.3	2.6	4	0.207
DB1P4250X	139	50"	42"	50	1.3	2.6	5	0.245
DB1P4254X	153	54"	42"	54	1.3	2.6	6	0.266
DB1P4266X	166	66"	42"	66	1.3	2.6	7	0.322
DB1P4274X	179	74"	42"	74	1.3	2.6	8	0.360
DB1P4282X	196	82"	42"	82	1.3	2.6	9	0.399
DB1P5050X	139	50"	50"	50	1.3	2.6	5	0.245
DB1P5054X	153	54"	50"	54	1.3	2.6	6	0.266
DB1P5058X	166	58"	50"	58	1.3	2.6	6	0.283
DB1P5066X	179	66"	50"	66	1.3	2.6	7	0.322
DB1P5074X	196	74"	50"	74	1.3	2.6	8	0.360
DB1P5082X	153	82"	50"	82	1.3	2.6	9	0.399
DB1P5458X	153	58"	54"	58	1.3	2.6	6	0.283
DB1P5466X	166	66"	54"	66	1.3	2.6	7	0.322
DB1P5474X	179	74"	54"	74	1.3	2.6	8	0.360
DB1P5482X	196	82"	54"	82	1.3	2.6	9	0.399
DB1P6666X	166	66"	66"	66	1.3	2.6	7	0.322
DB1P6674X	179	74"	66"	74	1.3	2.6	8	0.360
DB1P6682X	196	82"	66"	82	1.3	2.6	9	0.399

**Diet to System 3 "X" Configuration**

PRODUCT CODE	PRICE	SYSTEM 3 HEIGHT	DIET PANEL HEIGHT	SIZE/INCHES			WEIGHT VOL	
				H	W	D	LBS	FT <sup>3</sup>
DB3P4242X	123	42"	42"	42	1.3	2.6	4	0.207
DB3P4250X	139	50"	42"	50	1.3	2.6	5	0.245
DB3P4266X	166	66"	42"	66	1.3	2.6	7	0.322
DB3P5050X	139	50"	50"	50	1.3	2.6	5	0.245
DB3P5066X	139	66"	50"	66	1.3	2.6	7	0.322
DB3P5466X	166	66"	54"	66	1.3	2.6	7	0.322
DB3P5454X	166	54"	54"	54	1.3	2.6	6	0.266
DB3P6666X	166	66"	66"	66	1.3	2.6	7	0.322

**Diet to Boulevard 1 Overpanels**

PRODUCT CODE	PRICE	OVER PANEL HEIGHT	SIZE/INCHES			WEIGHT VOL	
			H	W	D	LBS	FT <sup>3</sup>
DB1OPPC08X	50	8"	8	1.3	2.6	0.8	0.043
DB1OPPC16X	55	16"	16	1.3	2.6	1.6	0.082
DB1OPPC24X	59	24"	24	1.3	2.6	2.5	0.120
DB1OPPC37X	69	37"	37	1.3	2.6	3.5	0.183
DB1OPPC42X	75	42"	42	1.3	2.6	4.0	0.207

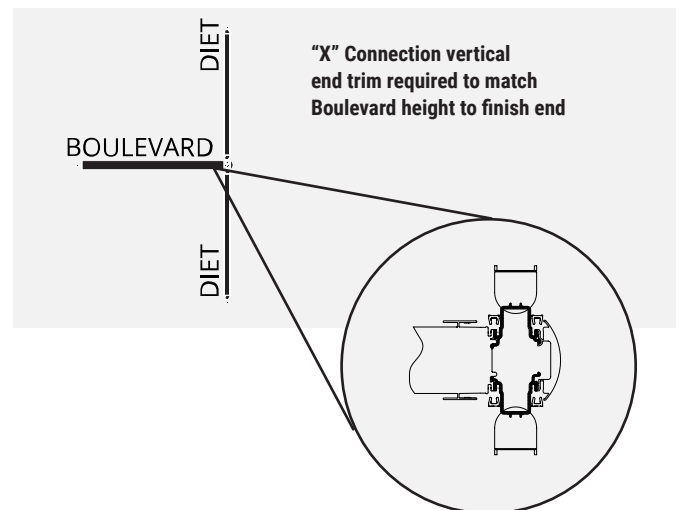
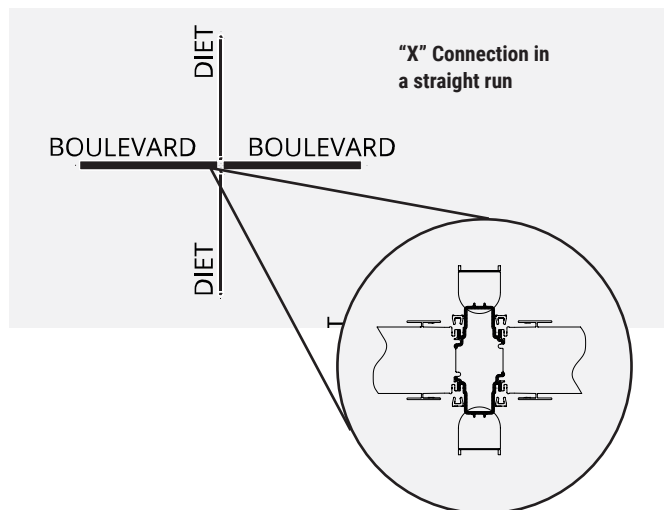

**DBXP-T • Diet to Boulevard Slim Connector in “T” Configuration**

- Creates a perpendicular connection between Diet Panel and Boulevard Panel that eliminates the need for special sized worksurfaces.
- Note: For use with regular DPxxxx panels.

**Diet to Boulevard 1 “T” Configuration**

PRODUCT CODE	PRICE	B1 HEIGHT	DIET PANEL HEIGHT	SIZE/INCHES			WEIGHT VOL	
				H	W	D	LBS	FT <sup>3</sup>
DB1P4242T	123	42"	42"	42	1.3	2.6	4	0.207
DB1P4250T	139	50"	42"	50	1.3	2.6	5	0.245
DB1P4258T	153	58"	42"	58	1.3	2.6	6	0.283
DB1P4266T	166	66"	42"	66	1.6	2.6	7	0.322
DB1P4274T	179	74"	42"	74	1.3	2.6	8	0.360
DB1P4282T	196	82"	42"	82	1.3	2.6	9	0.399
DB1P5050T	139	50"	50"	50	1.3	2.6	5	0.245
DB1P5058T	166	58"	50"	58	1.3	2.6	6	0.283
DB1P5066T	166	66"	50"	66	1.3	2.6	7	0.322
DB1P5074T	179	74"	50"	74	1.3	2.6	8	0.360
DB1P5082T	196	82"	50"	82	1.3	2.6	9	0.399
DB1P5458T	153	58"	54"	58	1.3	2.6	6	0.283
DB1P5466T	166	66"	54"	66	1.3	2.6	7	0.322
DB1P5474T	179	74"	54"	74	1.3	2.6	8	0.360
DB1P5482T	196	82"	54"	82	1.3	2.6	9	0.399
DB1P6666T	166	66"	66"	66	1.3	2.6	7	0.322
DB1P6674T	179	74"	66"	74	1.3	2.6	8	0.360
DB1P6682T	196	82"	66"	82	1.3	2.6	9	0.399

**Diet to System 3 “T” Configuration**

PRODUCT CODE	PRICE	SYSTEM 3 HEIGHT	DIET PANEL HEIGHT	SIZE/INCHES			WEIGHT VOL	
				H	W	D	LBS	FT <sup>3</sup>
DB3P4242T	123	42"	42"	42	1.3	2.6	4	0.207
DB3P4250T	139	50"	42"	50	1.3	2.6	5	0.245
DB3P4266T	166	66"	42"	66	1.3	2.6	7	0.322
DB3P5050T	167	50"	50"	50	1.3	2.6	5	0.245
DP3P5066T	162	66"	50"	66	1.3	2.6	7	0.322
DB3P5466T	166	66"	54"	66	1.3	2.6	7	0.322
DB3P6666T	166	66"	66"	66	1.3	2.6	7	0.322

**Diet to System 3 Overpanels**

PRODUCT CODE	PRICE	OVER PANEL HEIGHT	SIZE/INCHES			WEIGHT VOL	
			H	W	D	LBS	FT <sup>3</sup>
DB30PPC16	55	16"	16	1.3	2.6	1.6	0.082
DB30PPC32	69	32"	32	1.3	2.6	3.2	0.159

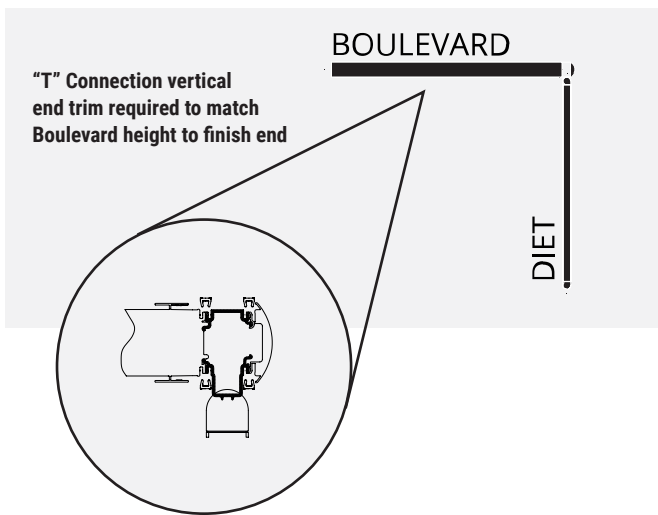
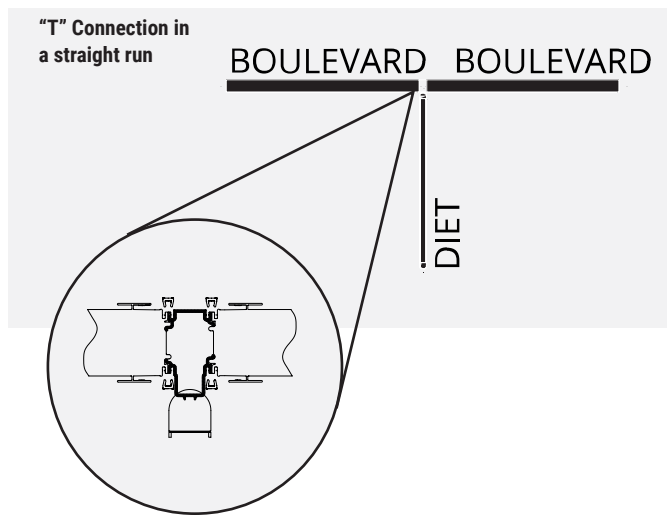

\* Please specify separate end trim (round or flat) to close end.

**DEK • Jumper Harness**

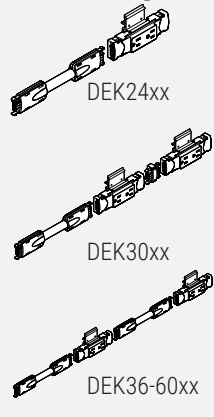

- Kit includes all components to add power to Diet Panels.
- Typical kit includes: 2 Duplex Receptacle Blocks (either circuit #1 or circuit #2), the Jumper Harness between the Duplex Receptacle Blocks, the Jumper Harness to the next panel, the pre-punched Raceway Cover, the aluminum Raceway Junction Cover, 2 PVC Duplex Receptacle Block Spacers and the hardware to attach the components.
- The length of the Jumper Harness between two Duplex Receptacle Blocks is based on the panel width.
- Jumper Harness going into the next panel and the aluminum Raceway Junction Covers are standard size.
- Raceway Cover and Raceway Junction Cover are Charcoal (CHR) only.
- Each kit is identified as circuit #1 (ie. DEK240"1") or circuit #2 (ie. DEK240"2").
- 24" wide panels have a single Duplex Receptacle Block only.
- 30" wide panels have 2 Duplex Receptacle Blocks, however they must be facing the same direction.
- 24" and 30" wide panels are not pre-punched for data.
- 36" to 60" wide panels are pre-punched for Duplex Receptacle Blocks on either side and for data just off-center on both sides.

PRODUCT CODE	PRICE	SIZE/INCHES			WEIGHT VOL	
		H	W	D	LBS	FT <sup>3</sup>
DEK2401	266	4	18	1.3	4.90	0.07
DEK3001	389	4	24	1.3	5.25	0.08
DEK3601	408	4	30	1.3	5.70	0.10
DEK4201	422	4	36	1.3	6.00	0.13
DEK4801	441	4	42	1.3	6.40	0.15
DEK5401	463	4	48	1.3	7.10	0.16
DEK6001	481	4	54	1.3	7.60	0.19
DEK2402	266	4	18	1.3	4.90	0.07
DEK3002	389	4	24	1.3	5.25	0.08
DEK3602	408	4	30	1.3	5.70	0.10
DEK4202	422	4	36	1.3	6.00	0.13
DEK4802	441	4	42	1.3	6.40	0.15
DEK5402	463	4	48	1.3	7.10	0.16
DEK6002	481	4	54	1.3	7.60	0.19

**DEJH • Diet Pass-Thru Kit**

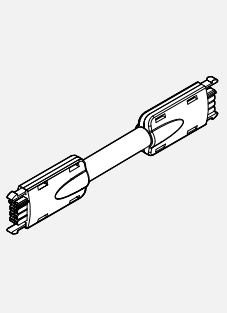

- Kit allows electrical to pass through a Diet Panel.
- Kit includes: female-female jumper harness, Raceway Cover and Raceway Junction Cover.
- Pass-Thru harness connects to a Duplex Receptacle Block within one powered panel; passes through a non-powered panel, and the opposite end connects to another Receptacle Block within the second powered panel.
- Raceway Cover and Raceway Junction Cover are Charcoal (CHR) only.

PRODUCT CODE	PRICE	SIZE/INCHES			WEIGHT VOL	
		H	L	D	LBS	FT <sup>3</sup>
DEJH24	182	2	42	1	1.81	0.025
DEJH30	207	2	48	1	2.07	0.028
DEJH36	226	2	54	1	2.12	0.032
DEJH42	245	2	60	1	2.60	0.035
DEJH48	263	2	66	1	2.86	0.038
DEJH54	284	2	72	1	3.13	0.041
DEJH60	301	2	78	1	3.39	0.044

**DEBF • Diet Base Feed**

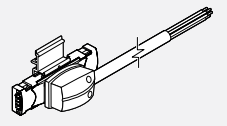

- Provides single power entry from floor into raceway.
- Single Ceiling Feed has a 6' whip, liquid tight.
- Raceway connection replaces one Duplex Receptacle Block in a standard kit.

PRODUCT CODE	PRICE	SIZE/INCHES			WEIGHT VOL	
		H	L	D	LBS	FT <sup>3</sup>
DEBF01	228	2	72	2	5.6	0.06

**DECF • Diet Ceiling Feed**



- Provides single power entry from ceiling through a post into raceway.
- Raceway connection replaces one Duplex Receptacle Block in a standard kit.

PRODUCT CODE	PRICE	SIZE/INCHES			WEIGHT VOL	
		H	L	D	LBS	FT <sup>3</sup>
DECF01	371	2	144	2	5.6	0.06

**DEPE • Diet Post Extension**



- Lightweight aluminum pole manages power and data cables between ceiling and floor level raceway.
- Aluminum extrusion with PVC extruded cover secures to the outside of the panel and passes through the worksurface scoop.
- Includes all hardware and bezel.
- Intended for use on Diet panels with fabric bottoms.

PRODUCT CODE	PRICE	SIZE/INCHES			WEIGHT VOL	
		H	W	D	LBS	FT <sup>3</sup>
DEPE116	255	116	4.5	1	7	0.82

**DERJC • Raceway Junction Cover**

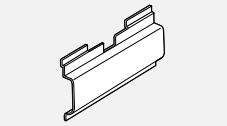

- Provides an external cover for cables passing between adjacent, in-line panels and off-module "X" panel configurations. Also, capable of bridging two in-line panels in a "T" configuration (outside).
- Aluminum, powder coated finish.

PRODUCT CODE	PRICE	SIZE/INCHES			WEIGHT VOL	
		H	W	D	LBS	FT <sup>3</sup>
DERJC	25	4.3	10	1	0.5	0.1

**DPL • Linking Panel - Levelers on Both Legs**

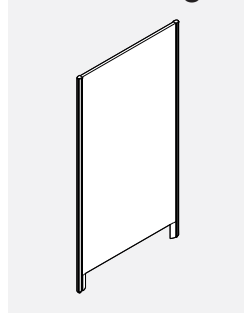

- Diet Linking Panel provides privacy.
- Aluminum extrusion comes in powder coated paint finish, DWT - Designer White or TUN - Tungsten.
- Laminate core available in DWTLTP - Designer White or ACJLP - Absolute Acajou.
- Edge banded to match laminate finish.
- Standard height of 54", 66", width in 6" increments from 24" to 60".
- Comes complete with hinge kits and levelers on both legs.

PRODUCT CODE	PRICE	SIZE / INCHES			WEIGHT VOL	
		H	W	D	LBS	FT <sup>3</sup>
DPL5424	534	54	24	1.3	18	1.62
DPL5430	593	54	30	1.3	23	2.08
DPL5436	652	54	36	1.3	27	2.47
DPL5442	711	54	42	1.3	32	2.85
DPL5448	770	54	48	1.3	37	3.25
DPL5454	829	54	54	1.3	42	3.63
DPL5460	887	54	60	1.3	47	4.02
DPL6624	606	66	24	1.3	23	2.04
DPL6630	670	66	30	1.3	29	2.52
DPL6636	736	66	36	1.3	35	3.00
DPL6642	802	66	42	1.3	41	3.46
DPL6648	865	66	48	1.3	47	3.93
DPL6654	930	66	54	1.3	53	4.40
DPL6660	994	66	60	1.3	59	4.90

**DPLSCH • Diet Laminate Panel - Single Caster on One Leg, Leveler on the Other**

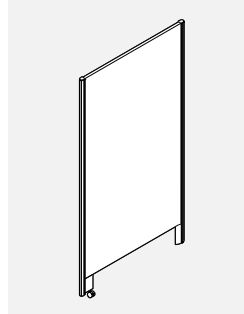

- Diet Linking Panel provides privacy.
- Aluminum extrusion comes in powder coated paint finish, DWT - Designer White or TUN - Tungsten.
- Laminate core available in DWTLTP - Designer White or ACJLP - Absolute Acajou.
- Edge banded to match laminate finish.
- Standard height of 54", 66", width in 6" increments from 24" to 60".
- Comes complete with hinge kits, caster on one leg and leveler on the other.

PRODUCT CODE	PRICE	SIZE / INCHES			WEIGHT VOL	
		H	W	D	LBS	FT <sup>3</sup>
DPLSCH5424	641	54	24	1.3	18	1.62
DPLSCH5430	703	54	30	1.3	23	2.08
DPLSCH5436	765	54	36	1.3	27	2.47
DPLSCH5442	825	54	42	1.3	32	2.85
DPLSCH5448	887	54	48	1.3	37	3.25
DPLSCH5454	949	54	54	1.3	42	3.63
DPLSCH5460	1011	54	60	1.3	47	4.02
DPLSCH6624	714	66	24	1.3	23	2.04
DPLSCH6630	781	66	30	1.3	29	2.52
DPLSCH6636	849	66	36	1.3	35	3
DPLSCH6642	917	66	42	1.3	41	3.46
DPLSCH6648	983	66	48	1.3	47	3.93
DPLSCH6654	1078	66	54	1.3	53	4.4
DPLSCH6660	1119	66	60	1.3	59	4.9

**DPLDF • Diet Linking Panel - Flat Foot on Both Legs**

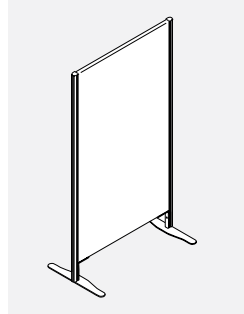

- Diet Linking Panel provides privacy.
- Aluminum extrusion comes in powder coated paint finish, DWT - Designer White or TUN - Tungsten.
- Laminate core available in DWTLTP - Designer White or ACJLP - Absolute Acajou.
- Edge banded to match laminate finish.
- Standard height of 54", 66", width in 6" increments from 24" to 60".
- Comes complete with hinge kits and flat foot on both legs.

PRODUCT CODE	PRICE	SIZE / INCHES			WEIGHT VOL	
		H	W	D	LBS	FT <sup>3</sup>
DPLDF5424	733	54	24	1.3	40.2	1.6
DPLDF5430	784	54	30	1.3	47.6	2.1
DPLDF5436	835	54	36	1.3	54.9	2.5
DPLDF5442	886	54	42	1.3	62.3	2.9
DPLDF5448	938	54	48	1.3	69.6	3.3
DPLDF5454	989	54	54	1.3	77.0	3.6
DPLDF5460	1041	54	60	1.3	84.3	4.0
DPLDF6624	794	66	24	1.3	48.6	2.0
DPLDF6630	849	66	30	1.3	57.9	2.5
DPLDF6636	906	66	36	1.3	67.3	3.0
DPLDF6642	961	66	42	1.3	76.6	3.5
DPLDF6648	1019	66	48	1.3	85.9	3.9
DPLDF6654	1074	66	54	1.3	95.2	4.4
DPLDF6660	1130	66	60	1.3	104.5	4.9

**DPLMN • Diet Linking Panel - Double Caster Base on Both Legs**

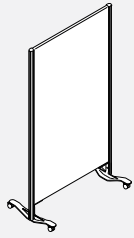

- Diet Linking Panel provides privacy.
- Aluminum extrusion comes in powder coated paint finish, DWT - Designer White or TUN - Tungsten.
- Laminate core available in DWTL P - Designer White or ACJLP - Absolute Acajou.
- Edge banded to match laminate finish.
- Standard height of 54", 66", width in 6" increments from 24" to 60".
- Comes complete with hinge kits, and double caster foot on both legs.

PRODUCT CODE	PRICE	SIZE / INCHES			WEIGHT VOL	
		H	W	D	LBS	FT <sup>3</sup>
DPLMN5424	777	54	24	1.3	41.8	1.6
DPLMN5430	846	54	30	1.3	49.1	2.1
DPLMN5436	913	54	36	1.3	56.5	2.5
DPLMN5442	979	54	42	1.3	63.8	2.9
DPLMN5448	1048	54	48	1.3	71.2	3.3
DPLMN5454	1116	54	54	1.3	78.5	3.6
DPLMN5460	1182	54	60	1.3	85.8	4.0
DPLMN6624	862	66	24	1.3	50.2	2.0
DPLMN6630	934	66	30	1.3	59.5	2.5
DPLMN6636	1009	66	36	1.3	68.8	3.0
DPLMN6642	1085	66	42	1.3	78.1	3.5
DPLMN6648	1159	66	48	1.3	87.4	3.9
DPLMN6654	1232	66	54	1.3	96.8	4.4
DPLMN6660	1307	66	60	1.3	106.1	4.9

**DPLDCMN • Diet Linking Panel - Single Caster on One Leg and Double Caster Base on the Other**

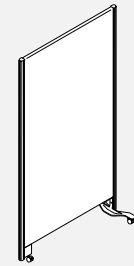

- Diet Linking Panel provides privacy.
- Aluminum extrusion comes in powder coated paint finish, DWT - Designer White or TUN - Tungsten.
- Laminate core available in DWTL P - Designer White or ACJLP - Absolute Acajou.
- Edge banded to match laminate finish.
- Standard height of 54", 66", width in 6" increments from 24" to 60".
- Comes complete with hinge kits, single caster on the one leg and double caster foot on the other.

PRODUCT CODE	PRICE	SIZE / INCHES			WEIGHT VOL	
		H	W	D	LBS	FT <sup>3</sup>
DPLDCMN5424	732	54	24	1.3	37.6	1.6
DPLDCMN5430	798	54	30	1.3	45.0	2.1
DPLDCMN5436	860	54	36	1.3	52.3	2.5
DPLDCMN5442	927	54	42	1.3	59.7	2.9
DPLDCMN5448	991	54	48	1.3	67.0	3.3
DPLDCMN5454	1053	54	54	1.3	74.4	3.6
DPLDCMN5460	1119	54	60	1.3	81.7	4.0
DPLDCMN6624	809	66	24	1.3	46.0	2.0
DPLDCMN6630	880	66	30	1.3	55.3	2.5
DPLDCMN6636	950	66	36	1.3	64.7	3.0
DPLDCMN6642	1020	66	42	1.3	74.0	3.5
DPLDCMN6648	1092	66	48	1.3	83.3	3.9
DPLDCMN6654	1162	66	54	1.3	92.6	4.4
DPLDCMN6660	1234	66	60	1.3	101.9	4.9

**DPLDCHN • Diet Linking Panel - Leveler on One Leg and Double Caster Base on the Other**

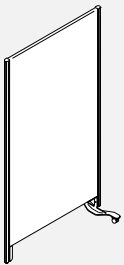

- Diet Linking Panel provides privacy.
- Aluminum extrusion comes in powder coated paint finish, DWT - Designer White or TUN - Tungsten.
- Laminate core available in DWTL P - Designer White or ACJLP - Absolute Acajou.
- Edge banded to match laminate finish.
- Standard height of 54", 66", width in 6" increments from 24" to 60".
- Comes complete with hinge kits, leveler on one leg and double caster foot on the other.

PRODUCT CODE	PRICE	SIZE / INCHES			WEIGHT VOL	
		H	W	D	LBS	FT <sup>3</sup>
DPLDCHN5424	689	54	24	1.3	37.1	1.6
DPLDCHN5430	750	54	30	1.3	44.5	2.1
DPLDCHN5436	817	54	36	1.3	51.8	2.5
DPLDCHN5442	883	54	42	1.3	59.2	2.9
DPLDCHN5448	945	54	48	1.3	66.5	3.3
DPLDCHN5454	1011	54	54	1.3	73.9	3.6
DPLDCHN5460	1075	54	60	1.3	81.2	4.0
DPLDCHN6624	765	66	24	1.3	45.5	2.0
DPLDCHN6630	836	66	30	1.3	54.9	2.5
DPLDCHN6636	906	66	36	1.3	64.2	3.0
DPLDCHN6642	976	66	42	1.3	73.5	3.5
DPLDCHN6648	1048	66	48	1.3	82.8	3.9
DPLDCHN6654	1119	66	54	1.3	92.1	4.4
DPLDCHN6660	1192	66	60	1.3	101.4	4.9

**DPLWA • Wall Connection for Linking Panels**

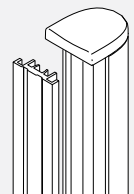

- Wall Connection connects Linking
- Panels to walls.
- Aluminum extrusion comes in powder coated paint finish, DWT - Designer White or TUN - Tungsten.
- Kit consists of Diet vertical extrusion, charcoal PVC cover and hinge kits.

PRODUCT CODE	PRICE	SIZE / INCHES			WEIGHT VOL	
		H	W	D	LBS	FT <sup>3</sup>
DPLWA54	139	54	2	2	2.3	0.13
DPLWA66	157	66	2	2	3.5	0.15

**DPLEKIT • Expanding Kit**

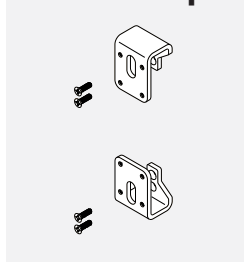

- Expanding Kit connects two linking panels in a straight line.
- This kit will accommodate any special width by overlapping the panels.
- Aluminum extrusion comes in powder coated paint finish, DWT - Designer White or TUN - Tungsten.
- Kit consists of a top and bottom bracket and all the hardware needed.

PRODUCT CODE	PRICE	SIZE/INCHES			WEIGHT VOL	
		H	W	D	LBS	FT <sup>3</sup>
DPLEKIT	242	3	2	2.0	1	0.05

**DP • Door and Door Catch Kit for Linking Panels**

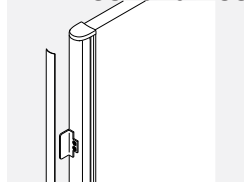

- Door Catch Kit converts any Linking Panel into a door.
- Aluminum extrusion comes in powder coated paint finish, DWT - Designer White or TUN - Tungsten.
- Kit consists of striker plate, two hinge kits, single caster foot assembly and 1" Diet caster

PRODUCT CODE	PRICE	SIZE/INCHES			WEIGHT VOL	
		H	W	D	LBS	FT <sup>3</sup>
DPDC01	151	6	3	1.3	2	0.50

**DP • Over Panel for Linking Panels**

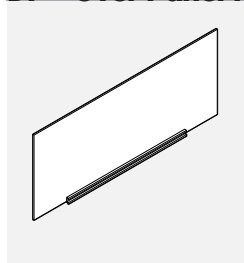

- Over Panel sits atop of Linking Panel and bridges the gap between the top of 66" high Linking Panel and the top of the Screening Booth.
- Kit contains aluminum extrusion and felt insert.
- Aluminum extrusion comes in powder coated paint finish, DWT - Designer White or TUN - Tungsten.

PRODUCT CODE	PRICE	SIZE/INCHES			WEIGHT VOL	
		H	W	D	LBS	FT <sup>3</sup>
DPLOP24	124	16.8	24	1.05	1.74	0.39
DPLOP30	146	16.8	30	1.05	2.20	0.49
DPLOP36	172	16.8	36	1.05	2.67	0.59
DPLOP42	191	16.8	42	1.05	3.14	0.70
DPLOP48	286	16.8	48	1.05	3.60	0.80
DPLOP54	309	16.8	54	1.05	4.07	0.90
DPLOP60	335	16.8	60	1.05	4.35	1.01

**DP • Booth to Linking Panel Connector**

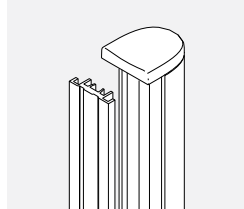

- Booth to Linking Panel Connector facilitates the connection of a Linking Panel to the back gable edge of the Screening Booth.
- Aluminum extrusion comes in powder coated paint finish, DWT - Designer White or TUN - Tungsten.
- Kit includes a Diet vertical extrusion, charcoal PVC cover and all hardware.

PRODUCT CODE	PRICE	SIZE/INCHES			WEIGHT VOL	
		H	W	D	LBS	FT <sup>3</sup>
DEBPA	107	66	3	1.3	3.5	0.15

**DPVAC • Diet VAC Laminate Panels**

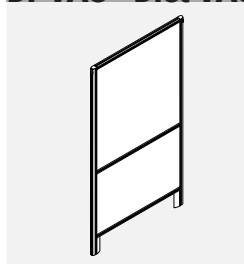

- Special panel construction designed specifically for clinical applications.
- Segmented panels offer a thermally fused laminate lower and high pressure upper pressed on a lightweight core.
- Minimal footprint for storage.
- Easy to connect.
- Easy to reconfigure.
- Easy to clean.
- Laminate core available in DWTL P/HP Designer White or ACJLP/ACJHP Absolute Acajou.
- Aluminum extrusion comes in powder coated paint finish. DWT Designer White or TUN Tungsten.
- Comes completed with hinge kits and levelers on both legs.

PRODUCT CODE	PRICE	SIZE/INCHES			WEIGHT VOL	
		H	W	D	LBS	FT <sup>3</sup>
DPVAC6636	928	66	36	1.3	35	3.00
DPVAC6642	956	66	42	1.3	41	3.46
DPVAC6648	976	66	48	1.3	47	3.93
DPVAC6660	1469	66	60	1.3	59	4.90



**DWS • Worksurface for Diet Panels**

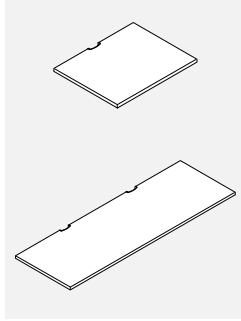

- Worksurfaces have scoops at back to allow wires and cables to pass to and from floor level.
- Includes support brackets (DHBRKT), 4 for worksurfaces up to 48", and 5 for any worksurface longer than 48".
- Please choose from DWT - Designer White, SIL - Silver or BLK - Black for scoop covers.

PRODUCT CODE	PRICE LP*	GROUP HP*	SIZE/INCHES			WEIGHT VOL	
			H	W	D	LBS	FT <sup>3</sup>
DWS2424P	134	166	1	24	24	15	0.60
DWS2430P	141	176	1	30	24	19	0.72
DWS2436P	161	201	1	36	24	23	0.85
DWS2442P	210	261	1	42	24	27	0.98
DWS2448P	252	314	1	48	24	31	1.11
DWS2454P	295	368	1	54	24	35	1.23
DWS2460P	333	414	1	60	24	39	1.36
DWS2466P	345	433	1	66	24	43	1.49
DWS2472P	362	452	1	72	24	48	1.62
DWS3024P	155	194	1	24	30	19	0.74
DWS3030P	168	211	1	30	30	24	0.90
DWS3036P	198	248	1	36	30	29	1.06
DWS3042P	280	350	1	42	30	34	1.22
DWS3048P	295	368	1	48	30	39	1.38
DWS3054P	323	405	1	54	30	43	1.54
DWS3060P	345	433	1	60	30	48	1.69
DWS3066P	361	448	1	66	30	53	1.85
DWS3072P	381	476	1	72	30	58	2.01

**BHC • Diet/Boulevard Worksurface 12" Cantilever Support**

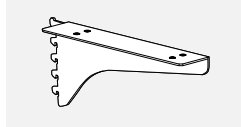

- An economical way to connect rear part of the side edge of a worksurface to the Boulevard Panel.
- Front part of the side edge of the worksurface must be supported by an off-module Diet Worksurface Bracket and locked into the adjacent Diet Panel.
- This cantilever is not a shared support

PRODUCT CODE	PRICE	SIZE/INCHES			WEIGHT VOL	
		H	W	D	LBS	FT <sup>3</sup>
BHC12L	41	6	2	12	2	0.03
BHC12R	41	6	2	12	2	0.03

**DHLEG • Diet Gable Leg**

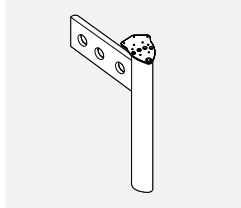

- Universal leg, plate and side panel are non handed.
- Supports the worksurface at 29" and enhances the stability of connected panels.
- Side plate is secured to the side of the Diet panel and leg plate bolts to worksurface.
- Made of extruded aluminum and steel.
- Levelers have 1.75" height adjustment.
- Includes all mounting hardware to connect to panel and worksurface.
- Must attach to Diet Panel vertical.

PRODUCT CODE	PRICE	SIZE/INCHES			WEIGHT VOL	
		H	W	D	LBS	FT <sup>3</sup>
DHLEG	185	28	23	6	12	2.02

**DHBRKT • Diet Worksurface Bracket**

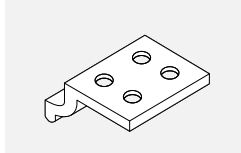

- Extruded aluminum bracket that is bolted to the underside of the worksurface.
- Bracket supports worksurface at any location along the mid rail of panel.
- Includes mounting hardware.
- Brackets are included for all worksurfaces DWS, 4 for worksurfaces up to 48", and 5 for any worksurface longer than 48".

PRODUCT CODE	PRICE	SIZE/INCHES			WEIGHT VOL	
		H	W	D	LBS	FT <sup>3</sup>
DHBRKT	11	0.75	2.25	3.25	0.1	0.05

**DHTBRKT • Diet Transaction Bracket**

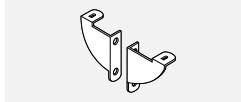

- Connects transaction tops to Diet Panels.
- Includes 1 set of two brackets and all hardware.

PRODUCT CODE	PRICE	SIZE/INCHES			WEIGHT VOL	
		H	W	D	LBS	FT <sup>3</sup>
DHTBRKT	43	2.5	1.2	2.5	3	0.01

**DWSCSB • Diet Support Bar**

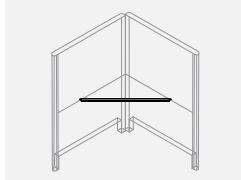

- Supports worksurface in 90 degree corner application and eliminates the need for a leg.
- Diagonally installed.
- If using a keyboard, spacers will be required.

PRODUCT CODE	PRICE	SIZE/INCHES			WEIGHT VOL	
		H	W	D	LBS	FT <sup>3</sup>
DWSCSB46	108	1	46	1	7	0.116
DWSCSB80	153	1	80	1	12	0.189

For corner application where 24" deep or smaller adjoining worksurface:  
For corner application where adjoining worksurface is larger than 24":

**DHOMC • Diet Off-Module Cantilever**

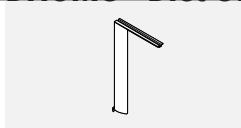

- To be used with Diet Panels that have a fabric bottom.
- Installs on horizontal rails of panels to provide worksurface support.
- Frees up space under the worksurface.

PRODUCT CODE	PRICE	SIZE/INCHES			WEIGHT VOL	
		H	W	D	LBS	FT <sup>3</sup>
DHOMC	108	21	3	12	4	0.42

**DSOMSHLF • Diet Off-Module 24" Shelf**

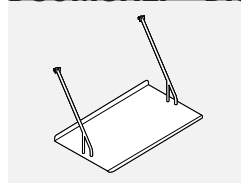

- Shelf hangs anywhere along Diet panel rails or Boulevard System 3 panel accessory tile.
- Can create a supplementary surface at worksurface level when suspended from a 42" high Diet panel.
- Shelves may be stacked, one hanging above the other from a higher rail.
- Shelf made of formed steel and includes suspended arms made of steel.

PRODUCT CODE	PRICE	SIZE/INCHES			WEIGHT VOL	
		H	W	D	LBS	FT <sup>3</sup>
DSOMSHLF	196	11.5	24	12	4	1.00

**DSOS • Diet Panel-Mounted Shelf**

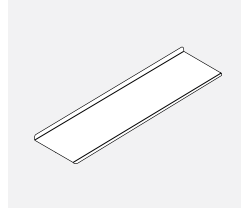

- Provides overhead storage capacity on top of 42" and 54" high Diet panels.
- Made of formed steel and includes steel mounting brackets.
- Support brackets lock to the top of Diet rail at the back and both sides of overhead.
- Must be installed on a "U" or "H" panel configuration.
- Due to structural issues, this product may not be used on top of glazed or partially glazed panels.

PRODUCT CODE	PRICE	SIZE/INCHES			WEIGHT VOL	
		H	W	D	LBS	FT <sup>3</sup>
DSOS48	265	15	48	13.5	40	5.60
DSOS60	265	15	60	13.5	52	7.00

**DOHLS • Diet Overhead Support**



- To be used with Diet back panel and Diet wing panel either left or right. The support leg will support only one side and eliminate the need for a third panel.
- To be used and supported on worksurface installed at standard height. Ensure the worksurface that the leg sits on is properly supported.

PRODUCT CODE	PRICE	SIZE/INCHES			WEIGHT VOL	
		H	W	D	LBS	FT <sup>3</sup>
DOHLS42	199	12	2	3.5	4	0.139
DOHLS54	199	24	2	3.5	6	0.278

**DSADA • Easy-Up Diet Overhead**

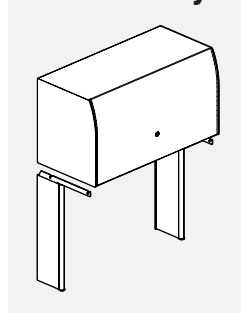

- Diet Panel-mounted metal overhead storage with opaque acrylic door. The Metal finish (page A.29). mechanism lifts the door up and stores it out of the way, above the storage unit.
- Meets CSA B651 Barrier Free Design & AODA (Accessibility for Ontarians with Disabilities Act).
- Meets CSA B651 Barrier Free Design & ADA (Americans with Disabilities Act).
- 16" high units accept standard and A4 binders.
- All shelves are reinforced for proper weight distribution.
- Inside dimensions: 14.375" high x 12" deep.
- Unit includes back, support cantilevers, attachment hardware, and lock.
- Shipped partially assembled.

PRODUCT CODE	PRICE	SIZE/INCHES			WEIGHT VOL	
		H	W	D	LBS	FT <sup>3</sup>
DSADA30PM	963	16	30	14.4	33	5.3
DSADA36PM	999	16	36	14.4	38	6.3
DSADA42PM	1047	16	42	14.4	43	7.3
DSADA48PM	1097	16	48	14.4	48	8.3
DSADA54PM	1146	16	54	14.4	53	9.3
DSADA60PM	1208	16	60	14.4	59	10.3

**DHPEDB • Pedestal Bracket Kit for Diet Panels**

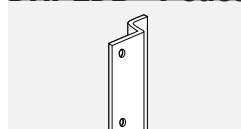

- Attaches to a metal Worksurface-Supporting Pedestal at the back and connects the pedestal to the Diet Panel vertical.

PRODUCT CODE	PRICE	SIZE/INCHES			WEIGHT VOL	
		H	W	D	LBS	FT <sup>3</sup>
DHPEDB	33	8	1	1	0.5	0.001

**BOULEVARD, BOULEVARD SYSTEM 3 AND DIET ERGONOMIC SOLUTIONS**

**Helping Office Inhabitants be Healthy and Efficient**

- Ergonomic Computer Accessories
- Energy Efficient Lighting and Power Accessories
- Paper Management Accessories
- Workstation Enhancement Accessories

For use with Boulevard, Boulevard System 3 & Diet (unless otherwise specified).

**GAKSM01 • Keyboard Support Mechanism**

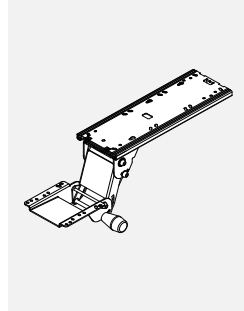

PRODUCT CODE	PRICE	SIZE / INCHES			WEIGHT VOL	
		H	W	D	LBS	FT <sup>3</sup>
GAKSM01	296	4.3	9	23.8	9.2	0.533

Height Range 6" (+1.0"/-5.5")  
Soft Touch Knob tilt adjustable range +15°/-15°  
360° base swivel

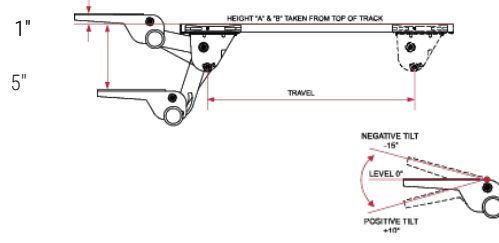

- Soft Touch Knob for simultaneous height & tilt adjustment.
- Spring-assist mechanism helps counter balance weight of keyboard & tray.
- Low-profile design for maximum leg room.
- Includes 21.75" under worksurface Glide Track
- Optional Glide Tracks available at no upcharge:
  - 12" Glide Track add suffix "12" (EXAMPLE GAKSM0112)
  - 18" Glide Track add suffix "18" (EXAMPLE GAKSM0118)
- Available in black only
- To be used with keyboard trays, sold separately.

**GAKSML • Slim-Fit Keyboard Support Mechanism**

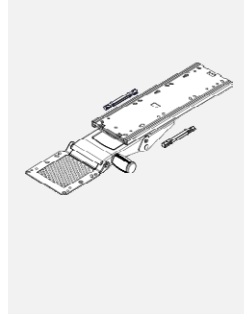

PRODUCT CODE	PRICE	SIZE / INCHES			WEIGHT VOL	
		H	W	D	LBS	FT <sup>3</sup>
GAKSML	389	4.75	9.5	24	9	0.627
GAKSMLW	389	4.75	9.5	24	9	0.627

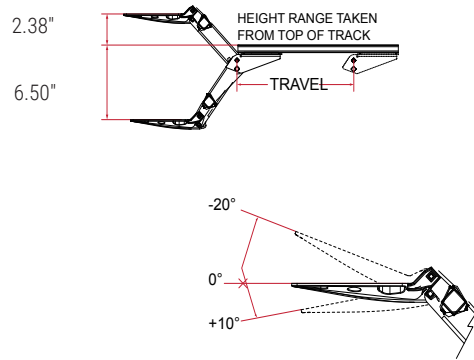

- Height Range 8.88" (+2.38" / - 6.5")
- Tilt Range (+10° / -20°)
- 360° Swivel.
- Meets ANSI/HFES, 100-2007 conformance requirement for height clearance.
- Super slim mechanism design increases clearance under the worksurface.
- Height & depth indicator incorporated together in an intelligently designed dashboard.
- Patented Lift-N-Lock™ height adjustment without knobs or levers automatically locks into position with release of tray for better AODA/Barrier Free compliance.
- Easy access to tilt control knob.
- Designed for disassembly and fully recyclable.
- Includes 21.75" undersurface Glide Track.
- Optional Glide Tracks available:
  - - 12" Glide Track add suffix "12" (EXAMPLE GAKSML12)
  - - 18" Glide Track add suffix "18" (EXAMPLE GAKSML18)
- "W" Indicated white finish.

**GAKSM02 • Lift-N-Lock Keyboard Support Mechanism**

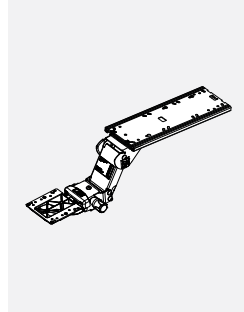

PRODUCT CODE	PRICE	SIZE / INCHES			WEIGHT VOL	
		H	W	D	LBS	FT <sup>3</sup>
GAKSM02	389	4.3	9	23.8	9.7	0.533

Height Range 8.38" (+2.25"/-6.13")  
Dial-Tilt Gauge shows precise tilt angles from +10°/-15° positions.  
360° base swivel

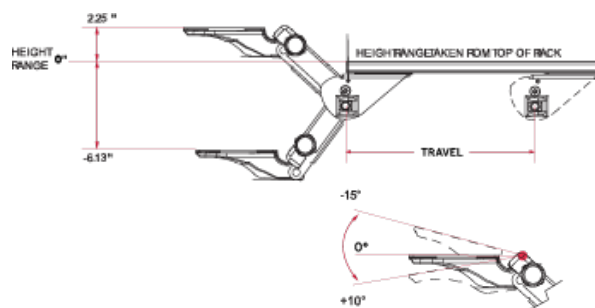

- Patent Pending Height Indicator Gauge allows for precise height setting when used by multiple users, or for returning to optimal height setting after storage.
- Exceeds BIFMA performance standards.
- Includes 21.75" under worksurface Glide Track
- Optional Glide Tracks available at no upcharge:
  - 12" Glide Track add suffix "12" (EXAMPLE GAKSM0212)
  - 18" Glide Track add suffix "18" (EXAMPLE GAKSM0218)
- Available in Black Only
- To be used with keyboard trays, sold separately.
- NOTE: Positive Tilt Lockout available. Contact your Customer Service Representative.
- Patented Lift-N-Lock™ height adjustment without knobs or levers automatically locks into position with release of tray for greater. Meets CSA B651 Barrier Free Design & AODA (Accessibility for Ontarians with Disabilities Act).

**GAKSM03 • Lift-N-Lock Keyboard Support Mechanism**

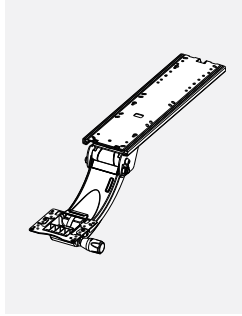

- Patent Pending Height Indicator Gauge allows for precise height setting when used by multiple users, or for returning to optimal height setting after storage.
- Curved neck allows user to be closer to the desk when in standing position.
- Exceeds BIFMA performance standards.
- Includes 21.75" under worksurface Glide Track
- Optional Glide Tracks available at no upcharge:
  - 12" Glide Track add suffix "12" (EXAMPLE GAKSM0312)
  - 18" Glide Track add suffix "18" (EXAMPLE GAKSM0318)
- Available in black only
- To be used with keyboard trays, sold separately.

- NOTE: Positive Tilt Lockout available. Contact your Customer Service Representative.
- Maximizes ergonomic support for both seated and standing positions.
- Patented Lift-N-Lock™ height adjustment without knobs or levelers automatically locks into position with release of tray for greater. Meets CSA B651 Barrier Free Design & AODA (Accessibility for Ontarians with Disabilities Act).

PRODUCT CODE	PRICE	SIZE/INCHES			WEIGHT VOL	
		H	W	D	LBS	FT <sup>3</sup>
GAKSM03	626	5.8	9	23.8	11.3	0.719

Height Range 14.13" (+8.25"/-5.88")  
Dial-Tilt Gauge shows precise tilt angles from +10°/-15° positions.  
360° base swivel

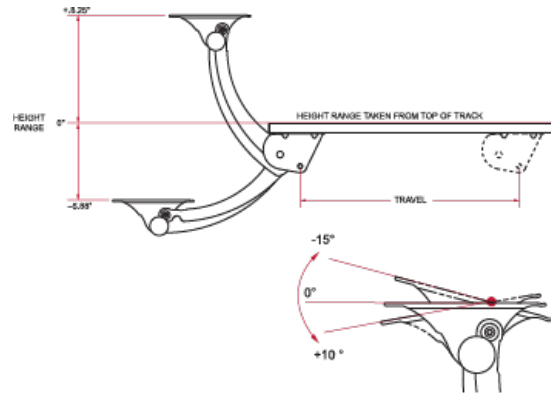

**GAKSM05 • Fixed-Mount Trackless Keyboard Arm**

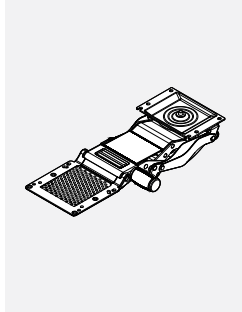

**Features:**

- Direct Mount, no track required.
- Ideal solution for FreeFit Tables.
- Total height adjustment of 5.73" (-1.25" to -6.98" under the desk surface).
- Enhanced patented Lift-N-Lock™ braking mechanism. Soft Touch Knob Dial Tilt with +10° to -15° tilt angles.
- Low profile tray head. Separate height and tilt gauges.
- 360° of swivel.
- Optional factory or field installable tilt lockout available.

**Benefits:**

- Full storage in 9 3/8" undersurface space.
- Exceeds HFES & BIFMA 5" percentile seated keyboarding heights (HFES 22" BIFMA 22.6").
- Easy height adjustment, providing superior lock up and stability with infinite adjustment.
- ADA Compliant tilt adjustment with easily accessible tilt knob.
- Greater knee clearance under desk surface.

PRODUCT CODE	PRICE	SIZE/INCHES			WEIGHT VOL	
		H	W	D	LBS	FT <sup>3</sup>
GAKSM05	411	5	13	9	6	0.317
GAKSM05W	411	5	13	9	6	0.317

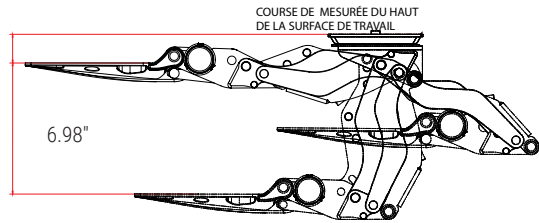

- Allows accurate, repeatable tray placement.
- Allows side to side arm movement.
- Locks out positive tilt for specific ergonomic applications or users preference.
- Provides increased storage where space permits.
- "W" indicated white finish.

**GATM01 • Tray With Sliding Mouse Support**

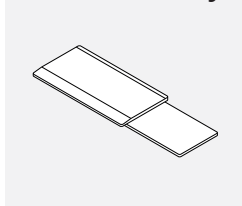

**MDF Tray:**

- Formed MDF with Textured Finish.
- Foam Anti-skid mat.
- Sliding Retractable Mouse Support:

**ABS tray**

- Sliding Retractable Mouse Support slides below the tray for left or right mouse positioning.
- Extends 9.91" beyond the end of the Keyboard Tray.
  - 33% recycled content by weight content) and |
  - 92.64% recyclable.
- Available in black only

PRODUCT CODE	PRICE	SIZE/INCHES			WEIGHT VOL	
		H	W	D	LBS	FT <sup>3</sup>
GATM01	299	2	21.3	10.5	7	0.259

**GATM02 • 27" HDPE Tray With Two Mousing Surfaces**

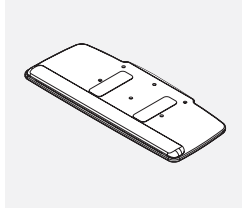

**HDPE Tray:**

- 1/2" thick High Density Polyethylene with textured finish.
- Includes removable plug-in, gel free foam palm rest.
- Anti-skid strips.

**Mousing Surface:**

- Keyboard and Mouse can be set up left or right.
- Includes Mouse Fence with Cable Manager.
  - 92.64% recyclable.
- Available in black only

PRODUCT CODE	PRICE	SIZE/INCHES			WEIGHT VOL	
		H	W	D	LBS	FT <sup>3</sup>
GATM02	384	1	27	11	6	0.179

**GATM03 • Phenolic Tray With Height-Adjustable Mouse Support**

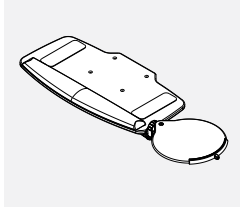

- **Height-Adjustable Mouse Support:**
- Ergonomic adjustment of tilt, swivel & height adjustment.
- Can be mounted either left or right.
- Includes mouse fence with cable manager.
- Available in black or white.
- "W" indicates white finish.

PRODUCT CODE	PRICE	SIZE/INCHES			WEIGHT VOL	
		H	W	D	LBS	FT <sup>3</sup>
GATM03	435	2.8	20.5	11	5.8	0.429
GATM03W	435	2.8	20.5	11	5.8	0.429

- **Phenolic Tray:**
- Solid low profile keyboard tray.
- Graphite finish helps hide fingerprints and smudges.
- Includes removable plug-in, gel-free foam palm rest.
- Includes foam Anti-skid strips.

**GATM04 • HDPE Tray With Height-Adjustable Mouse Support**

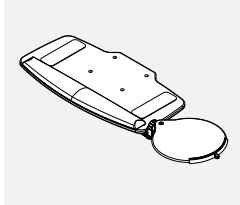

- **HDPE Tray:**
- 1/2" thick High Density Polyethylene with textured finish.
- Includes removable plug-in, gel free foam palm rest.
- 45% recycled content by weight (45%Post Industrial content) and 99.97% recyclable.
- Includes foam anti-skid strips.

PRODUCT CODE	PRICE	SIZE/INCHES			WEIGHT VOL	
		H	W	D	LBS	FT <sup>3</sup>
GATM04	464	3.2	20.5	11	6	0.5

- **Height-Adjustable Mouse Support:**
- Ergonomic adjustment of tilt, swivel & height adjustment.
- Can be mounted either left or right.
- Includes mouse fence with cable manager.
  - 92.64% recyclable.
- Available in black only.

**GAGTA01 • Glide Tray Adapter (Set of 2)**

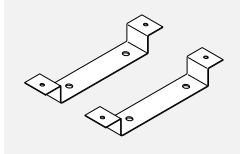

- Attaches to Glide Tracks of all Keyboard Mechanisms and Sliding CPU Holders found within this price list.
- Mounting hardware included.
- Available in black only.
- Not required for use with GAKSM05.

PRODUCT CODE	PRICE	SIZE/INCHES			WEIGHT VOL	
		H	W	D	LBS	FT <sup>3</sup>
GAGTA01	123	2.5	9	2	0.5	0.025

- Accommodates the placement of sliding keyboard mechanisms and CPU holders below the cross beam of a table.

**KEYBOARD COMBINATION CHART • PACKAGE CODES AND PRICING**

"W" at the end of the code designates white keyboard.  
 "W" before 2 numbers designates white mechanism.  
 "W" in both places in code designates white keyboard and mechanism.



 GAKSM01	GAKSP0101 \$594	GAKSP0102 \$680	GAKSP0103 / GAKSP103W \$730	GAKSP0104 \$757
 GAKSML/GAKSMLW	GAKSPML01 / GAKSPMLW01 \$689	GAKSPML02 / GAKSPMLW02 \$775	GAKSPML03 / GAKSPML03W / GAKSPMLW03 / GAKSPMLW03W \$825	GAKSPML04 / GAKSPMLW04 \$853
 GAKSM02	GAKSP0201 \$689	GAKSP0202 \$775	GAKSP0203 / GAKSP0203W \$825	GAKSP0204 \$853
 GAKSM03	GAKSP0301 \$924	GAKSP0302 \$1010	GAKSP0303 / GAKSP0303W \$1060	GAKSP0304 \$1089
 GAKSM05/GAKSM05W	GAKSP0501 / GAKSP0501W \$709	GAKSP0502 / GAKSP0502W \$795	GAKSP0503 / GAKSP0503W / GAKSP0503W \$826	GAKSP0504 / GAKSP0504W \$874

**GACPU01 • Fixed-Mount CPU Holder**

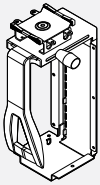

- Fully adjustable clamping mechanism to accept tower CPU's with a wide range of 3.5" to 9.3" and a height range of 12.5" to 22.5".
- Soft Touch knob for side clamp adjustment and bayonet lance for vertical height adjustment.
- Directly mounts to underside of desk surface.
- CPU Holder can also be mounted directly to an upright desk leg surface or wall, via side mounting holes.
- Manufactured from Steel and Engineered Resin, providing rugged durability and support.
- Available in Black Only

PRODUCT CODE	PRICE	SIZE/INCHES			WEIGHT VOL	
		H	W	D	LBS	FT <sup>3</sup>
GACPU01	245	18.5	11.7	9.2	9	1.152

**GACPU02 • CPU Holder on Glide Track**

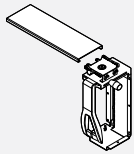

- Accepts tower CPU's with a width range of 3.5" to 9.3" and a height range of 12.5" to 22.5".
- Soft Touch knob for side clamp adjustment and bayonet lance for vertical height adjustment.
- 12" Glide Track mounted and 360° swivel for easy access for rear of CPU
- Manufactured from Steel and Engineered Resin, providing rugged durability and support.
- Available in Black Only

PRODUCT CODE	PRICE	SIZE/INCHES			WEIGHT VOL	
		H	W	D	LBS	FT <sup>3</sup>
GACPU02	352	18.5	11.7	9.2	12.6	1.152

**GACPUH • Woof CPU Holder**

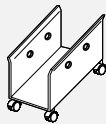

- Provides convenience access to front and back of CPU.
- Expandable width accommodates various sizes of CPU's. Adjusts from 7" to 10".
- Includes 4 locking casters and 4 protective "O" rings.
- Available in Tungsten Only

PRODUCT CODE	PRICE	SIZE/ INCHES			WEIGHT VOL	
		H	W	D	LBS	FT <sup>3</sup>
GACPUH	188	11	16	7-10	5	1.0

**GAAKS1818 • CRT Corner Plate**

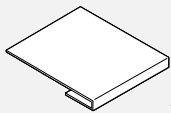

- Converts two abutting worksurfaces in a 90° corner into a 45° angle keyboard worksurface.
- Keyboard mechanism not included.
- Fits worksurfaces 1" to 1.25" thick.
- Available in Panel Frame Finish

PRODUCT CODE	PRICE	SIZE/INCHES			WEIGHT VOL	
		H	W	D	LBS	FT <sup>3</sup>
GAAKS1818	136	1.25	18	18	3.7	0.454

**GAMA1 • Single Clamp-Mount Monitor Arm**

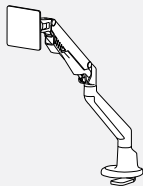

**NEW!**

- Finger touch dynamic height adjustment, 12" height range. 4.4 to 19.8 lbs. per monitor loading capacity; accepts screen size 17" - 30".
- Maximum of 22" extension from rear of desk to back of monitor, folds to 5.5".
- Tilt, pan and landscape to portrait rotation; quick release VESA plate, 180 degree lock out.
- Clamp mount and grommet mount options included, accommodates 0.5" to 1.9" thick tops.
- Accepts mini slide arm GAMS.
- Available in SIL - Silver only.

PRODUCT CODE	PRICE	SIZE/INCHES			WEIGHT VOL	
		H	W	D	LBS	FT <sup>3</sup>
GAMA1	690	21		5.5	6.6	0.4

**GAMA2 • Double Clamp-Mount Monitor Arm**

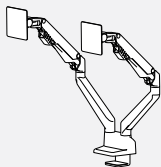

**NEW!**

- Finger touch dynamic height adjustment, 12" height range. 4.4 to 19.8 lbs. per monitor loading capacity; accepts screen size 17"-30".
- Maximum of 22" extension from rear of desk to back of monitor, folds to 5.5".
- Tilt, pan and landscape to portrait rotation; quick release VESA plate, 180 degree lock out.
- Clamp mount and grommet mount options included, accommodates 0.67" to 2.3" thick tops.
- Accepts mini slide arm GAMS.
- Available in SIL - Silver only.

PRODUCT CODE	PRICE	SIZE/INCHES			WEIGHT VOL	
		H	W	D	LBS	FT <sup>3</sup>
GAMA2	1211	21		5.5	12.8	1

**GAMS • Mini Slide Monitor Arm**

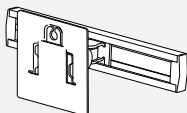

**NEW!**

- Works with GAMA1 and GAMA2 monitor arms.
- 11.8" slide, loading capacity 13.2lbs.
- Quick release VESA plate.
- Available in SIL - Silver only.

PRODUCT CODE	PRICE	SIZE/INCHES			WEIGHT VOL	
		H	W	D	LBS	FT <sup>3</sup>
GAMS	240	4.5	11	6	3.3	0.3

**MONITOR ARM SPECS**

- VESA Mounting plate contains 75 mm & 100 mm mounting configuration
- VESA Plate head is fully adjustable with 180° of tilt, 180° of swivel and 360° of rotation for portrait to landscape viewing
- Keyhole slots in VESA Plate for quick mounting of Display Screen
- Counterbalance spring mechanism does not contain gas cylinders (that are prone to leakage)
- Cable Management provided on arm swivel joints
- Arm components manufactured from 100% recyclable aluminum die cast material, providing stability and durability
- 13" Arm height adjustment on 11" Stainless Steel Pole.
- Pole Support Ring doubles as cable manager.
- 360° of arm swivel around pole.
- Desk Clamp and Grommet mounting options standard on pole applications.
- Monitor arms available in Silver (SIL), Black (BLK), or White (WHT).

**GAMCSSDE • Double Extension Monitor Arm for Single Screen**

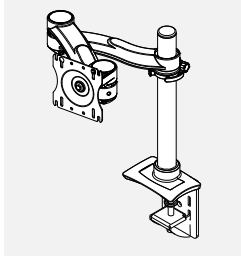

- Monitor Arm Single Screen Dual Arm Extension.
- 9 1/2" reach from center of pole to front of VESA Plate
- Display Viewing - 180° of tilt, 180° of swivel and 360° of rotation.
- Quick Mount Versa Plate.
- 12" Pole Adjustment.
- 9" Chrome pole adjustment.

Available in Silver (SIL), Black (BLK) or White (WHT).  
• Post is chromed.

PRODUCT CODE	PRICE	SIZE/INCHES			WEIGHT VOL	
		H	W	D	LBS	FT <sup>3</sup>
GAMCSSDE	617	29.3	6.8	9.5	7.5	1.095

**GAMCSSDEH • Double Extension With Height-Adjustable Monitor Arm for Single Screen**

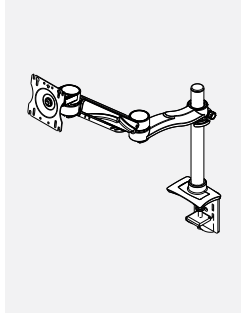

- Double extension with height-adjustable monitor arm for single screen frees up worksurface space and supports a sit/stand working posture.
- Attaches to the edge of the worksurface or through a grommet.
- Monitor arm adjusts from 3" to 12" from the worksurface.
- Counterbalanced arm provides an additional 13" of height adjustment.
- Monitor connecting bracket swivels 360 degrees and tilts +/- 90 degrees (180 degrees).
- Double extension has 19" of back and forth movement to allow for different focal depths of viewing comfort.
- Built-in cable clips on underside of extension arms and pole base allows organized cable management.
- Available in Silver (SIL), Black (BLK) or White (WHT).
- Post is chromed.

PRODUCT CODE	PRICE	SIZE/INCHES			WEIGHT VOL	
		H	W	D	LBS	FT <sup>3</sup>
GAMCSSDEH	741	29.3	6.8	9.5	8.2	1.095

**GAMCDSDE • Monitor Arms for Dual Screens**

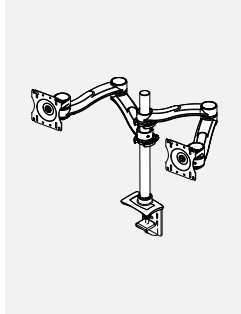

- Double extension monitor arms for dual screens frees up worksurface space.
- Used for side-by-side or back-to-back applications.
- Attaches to the edge of the worksurface or through a grommet.
- Monitor arm adjusts from 3" to 12" from the worksurface.
- Monitor connecting extension has 19" of back and forth movement to allow for different focal depths of viewing comfort.
- Max 32" screen width.
- Built-in cable clips on underside of extension arms and pole base allows organized cable management.
- Available in Silver (SIL), Black (BLK) or White (WHT).
- Post is chromed.

PRODUCT CODE	PRICE	SIZE/INCHES			WEIGHT VOL	
		H	W	D	LBS	FT <sup>3</sup>
GAMCDSDE	1090	29.3	6.8	9.5	10.7	1.095

**GAMCDSDEH • Double Extension With Height-Adjustable Monitor Arms for Dual Screens**

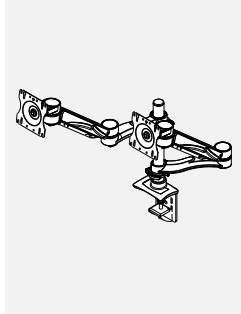

- Double extension with height-adjustable monitor arms for dual screens frees up the worksurface space and supports a sit/stand working posture.
- Used for side-by-side or back-to-back applications.
- Attaches to the edge of the worksurface or through a grommet.
- Monitor arm adjusts from 3" to 12" from the worksurface.
- Counterbalanced arm provides an additional 13" of height adjustment.
- Monitor connecting bracket swivels 360 degrees and tilts +/- 90 degrees (180 degrees).
- Double extension has 19" of back and forth movement to allow for different focal depths of viewing comfort.
- Built-in cable clips on underside of extension arms and pole base allows organized cable management.
- Max 35" screen width.
- Available in Silver (SIL), Black (BLK) or White (WHT).
- Post is chromed.

PRODUCT CODE	PRICE	SIZE/INCHES			WEIGHT VOL	
		H	W	D	LBS	FT <sup>3</sup>
GAMCDSDEH	1350	29.3	6.8	9.5	12.2	1.095

**GAMLDM20 • Single-Screen Monitor Arm for 5 to 20lbs**

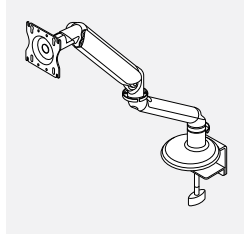

- Comes with clamp and grommet mount, ideal for all desk mounting configurations, minimizing SKU's.
- Adjustable counterbalance cylinder provides smooth 14 ½" of height adjustment with fingertip control. - counterbalances monitors from 5 lbs. to 20 lbs.
- Double extension arms provide a maximum of 26 ¾" extension from the rear edge of the mounting surface to the VESA Plate for greater monitor adjustment on deep or corner workstations.
- Arms fold back to a minimum dimension of 4 1/2" to provide maximum desk utilization.
- Monitor mounting bracket, with Quick Connect adaptor, contains both 75mm & 100mm hole patterns to match most screen types and compliant with VESA mounting standards.
- Weight gauge provided to allow for quick and easy counterbalance adjustment of the arm prior to installing the screen. Saves time and guesswork especially for multiple arm installations.
- VESA Plate rotates for portrait or landscape viewing with 180° side to side rotation and -90° to +45° tilt for optimal viewing adjustment.
- Die cast aluminum construction provides greater stability and contains high recycled material content with full recyclability.
- Adjustable rotation limiter to restrict arm rotation to 180°, preventing arms from hitting walls.
- Comes with all tools and mounting hardware for quick and easy installation (Tool-free).
- Available in Silver (SIL), Black (BLK) or White (WHT).

PRODUCT CODE	PRICE	SIZE/INCHES			WEIGHT VOL	
		H	W	D	LBS	FT <sup>3</sup>
GAMLDM20	644	38	6	8.5	10.23	1.122

**GAMLDM30 • Single-Screen Monitor Arm for 10 to 30lbs**

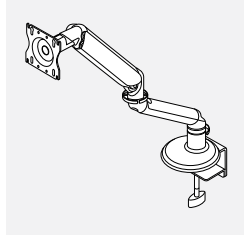

- Comes with clamp and grommet mount, ideal for all desk mounting configurations, minimizing multiple SKU's
- Adjustable counterbalance cylinder provides smooth 14 1/2" of height adjustment with fingertip control - counterbalances monitors from 10 lbs. to 30 lbs.
- Double extension arms provides a maximum of 26.7" extension from the rear edge of the mounting surface to the VESA Plate for greater monitor adjustment on deep or corner workstations
- Arms fold back to a minimum dimension of 4 1/2" to provide maximum desk utilization
- Monitor mounting bracket with Quick Connect adaptor, contains both 75mm & 100mm hole patterns to match most screen types and compliant with VESA mounting standards
- Weight gauge provided to allow for quick and easy counterbalance adjustment of the arm prior to installing the screen.
- Saves time and guesswork especially for multiple arm installations VESA Plate rotates for portrait and landscape viewing with 180° side to side rotation and -90° to +45° tilt for optimal viewing adjustment
- Die cast aluminum construction provides greater stability and contains high recycled material content with full recyclability
- Adjustable rotation limiter to restrict arm rotation to 180°, preventing arms from contacting walls
- Comes with all tools and mounting hardware for quick and easy installation (Tool-free)
- Available in Silver (SIL), Black (BLK) or White (WHT).

PRODUCT CODE	PRICE	SIZE/INCHES			WEIGHT VOL	
		H	W	D	LBS	FT <sup>3</sup>
GAMLDM30	691	38	6	8.5	10.23	1.122

**GAMLDM40 • Dual-Screen Monitor Arm for 6 to 28lbs**

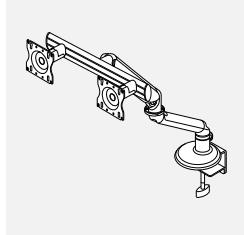

- Comes with clamp and grommet mount, ideal for all desk mounting configurations, minimizing multiple SKU's
- Adjustable counterbalance cylinder provides smooth 14 1/2" of height adjustment with fingertip control and a counterbalance range from 6 lbs. to 28 lbs combined.
- Double extension arms provide a maximum of 30 ¾" extension from the rear edge of the mounting surface to the VESA Plate for greater monitor adjustment on deep or corner workstations
- Arms fold back to a minimum dimension of 8 3/8" to provide maximum desk utilization
- Monitor mounting bracket with Quick Connect Adaptor, contains both 75mm & 100mm hole patterns to match most screen types and is compliant with VESA mounting standards
- Weight gauge provided to allow for quick and easy counterbalance adjustment of the arm prior to installing the screen.
- Saves time and guesswork especially for multiple arm installations.
- VESA Plate rotates for portrait and landscape viewing with 180° side to side rotation and -90° to +45° tilt for optimal viewing adjustment
- Die cast aluminum construction provides greater stability and contains high recycled material content with full recyclability
- Adjustable rotation limiter to restrict arm rotation to 180°, preventing arms from contacting walls
- Comes with all tools and mounting hardware for quick and easy installation (Tool-free)
- Available in Silver (SIL), Black (BLK) or White (WHT).

PRODUCT CODE	PRICE	SIZE/INCHES			WEIGHT VOL	
		H	W	D	LBS	FT <sup>3</sup>
GAMLDM40	830	38	6.25	8.5	12.75	1.168



**BLVELEDVS • LED Single-Arm Lamp**



- 7 System watts, 18-fractional LEDs.
- 3500K 250 lumens, 84 CRI.
- Soft touch - instant on, fade to off.
- Infinite dimming 100% down to 15%, last state memory.
- Standard 10 hours turn off (ATO).
- 50,000 hour life LEDs.
- 15 watt, 24 volt wall transformer, 6' cord.
- White (WHT) Silver (SIL) or Black (BLK) - Must specify color choice.
- UL, CUL and CSA compliant, ETL Listed.
- Base not included.

PRODUCT CODE	PRICE	SIZE/INCHES			WEIGHT VOL	
		H	W	D	LBS	FT <sup>3</sup>
BLVELEDVS	616	8	7	33	7.3	0.98
<b>With Occupancy Sensor</b>						
BLVELEDVSO	920	10	9	35	8.3	1.51

**BLVELEDVD • LED Double-Arm Lamp**

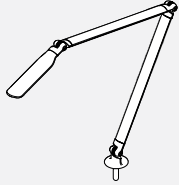

- 7 System watts, 18-fractional LEDs.
- 3500K 250 lumens, 84 CRI.
- Double arm articulation with 20" base to head reaches.
- Soft touch - instant on, fade to off.
- Infinite dimming 100% down to 15%, last state memory.
- Standard 10 hours turn off (ATO).
- 50,000 hour life LEDs.
- 15 watt, 24 volt wall transformer, 6' cord.
- White (WHT) Silver (SIL) or Black (BLK) - Must specify color choice.
- UL, CUL and CSA compliant, ETL Listed.
- Base not included.

PRODUCT CODE	PRICE	SIZE/INCHES			WEIGHT VOL	
		H	W	D	LBS	FT <sup>3</sup>
BLVELEDVD	646	8	7	33	7.6	1.02
<b>With Occupancy Sensor</b>						
BLVELEDVDO	931	10	9	35	8.6	1.57

**BLVELEDRS • LED Single-Arm Lamp**

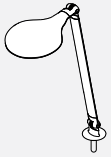

- 7 System watts, 18-fractional LEDs.
- 3500K 250 lumens, 84 CRI.
- Soft touch - instant on, fade to off.
- Infinite dimming 100% down to 15%, last state memory.
- Standard 10 hours turn off (ATO).
- 50,000 hour life LEDs.
- 15 watt, 24 volt wall transformer, 6' cord.
- White (WHT) Silver (SIL) or Black (BLK) - Must specify color choice.
- UL, CUL and CSA compliant, ETL Listed.
- Base not included.

PRODUCT CODE	PRICE	SIZE/INCHES			WEIGHT VOL	
		H	W	D	LBS	FT <sup>3</sup>
BLVELEDRS	616	8	7	33	7.3	0.98
<b>With Occupancy Sensor</b>						
BLVELEDRSO	920	10	9	35	8.3	1.51

**BLVELEDRD • LED Double-Arm Lamp**

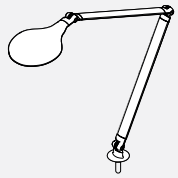

- 7 System watts, 18-fractional LEDs.
- 3500K 250 lumens, 84 CRI.
- Double arm articulation with 20" base to head reaches.
- Soft touch - instant on, fade to off.
- Infinite dimming 100% down to 15%, last state memory.
- Standard 10 hours turn off (ATO).
- 50,000 hour life LEDs.
- 15 watt, 24 volt wall transformer, 6' cord.
- White (WHT) Silver (SIL) or Black (BLK) - Must specify color choice.
- UL, CUL and CSA compliant, ETL Listed.
- Base not included.

PRODUCT CODE	PRICE	SIZE/INCHES			WEIGHT VOL	
		H	W	D	LBS	FT <sup>3</sup>
BLVELEDRD	633	8	7	33	7.6	1.02
<b>With Occupancy Sensor</b>						
BLVELEDRDO	931	10	9	35	8.6	1.57

## Lamp Mounting Options



White (WHT) Silver (SIL) or Black (BLK) - Must specify color choice.

### Grommet Mount

PRODUCT CODE	PRICE	SIZE/INCHES			WEIGHT VOL	
		H	W	D	LBS	FT <sup>3</sup>
BLVELEDASM	155	3	6	6	3	0.06



### Worksurface Clamp Mount

PRODUCT CODE	PRICE	SIZE/INCHES			WEIGHT VOL	
		H	W	D	LBS	FT <sup>3</sup>
BLVELEDASCM	155	3	6	6	2	0.04



### Slat Wall Mount

PRODUCT CODE	PRICE	SIZE/INCHES			WEIGHT VOL	
		H	W	D	LBS	FT <sup>3</sup>
BLVELEDASW	155	3	6	6	3	0.06



### Panel Mount

PRODUCT CODE	PRICE	SIZE/INCHES			WEIGHT VOL	
		H	W	D	LBS	FT <sup>3</sup>
BLVELEDAPM	155	3	6	6	3	0.06

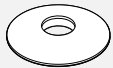

### Freestanding Base

PRODUCT CODE	PRICE	SIZE/INCHES			WEIGHT VOL	
		H	W	D	LBS	FT <sup>3</sup>
BLVELEDAFS	173	4	12	12	6	0.50

## GCLEDESxx • Undercabinet LED Task Light

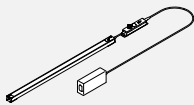

- **Linear LED Light.**
- Includes light fixture with lens and ON/OFF switch.
- Magnet mounted with optional adhesive metal plates.
- Plug-in power supply with 72" cord length plus 78" DC cord.
- Technical information:
- 4100 K Color Temperature
- 90 Color Rendering Index
- 30,000 hrs rated Lifespan
- Total power input per light, 9.0 for 24", 13.5 per 36" and 18.0 for 48"

PRODUCT CODE	PRICE	SIZE/INCHES			WEIGHT VOL	
		H	W	D	LBS	FT <sup>3</sup>
GCLEDES24	227	1	22.9	1	2.5	0.135
GCLEDES36	261	1	33.5	1	2.8	0.161
GCLEDES48	291	1	45.5	1	3.2	0.213

## GCLEDESxxDCS • Undercabinet Daisychain LED Light

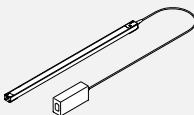

- **Undercabinet LED light, 48 inches nominal size , daisychain unit with 1 meter (39 inches) linking cable but no power supply.**
- Daisychain units can only be linked up to a total of 48 Watts for all lights on one power supply. This equates to a maximum of 10 feet total nominal length of lights per power supply.
- Technical information:
- 4100 K Color Temperature
- 90 Color Rendering Index
- 30,000 hrs rated Lifespan
- Total power input per light, 9.0 for 24", 13.5 per 36" and 18.0 for 48"

PRODUCT CODE	PRICE	SIZE/INCHES			WEIGHT VOL	
		H	W	D	LBS	FT <sup>3</sup>
GCLEDES24DSC	185	1	24	1	2.5	0.135
GCLEDES36DSC	220	1	36	1	2.8	0.161
GCLEDES48DSC	249	1	48	1	3.2	0.213

## GCLEDESOS • Occupancy Sensor and Dimmer

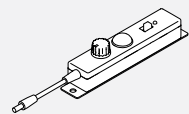

- **Inline add-on controller for dimming & occupancy sensor.**
- Included, from right to left, a rotary dimmer control, an occupancy sensor and a sensor bypass switch.

PRODUCT CODE	PRICE	SIZE/INCHES			WEIGHT VOL	
		H	W	D	LBS	FT <sup>3</sup>
GCLEDESOS	91	6	2.5	2	0.4	0.500

**BEMAE • Mini-Adapt Power Module**



- Accessory Data/Power House.
- Attaches to scoop at the back of a worksurface.
- BEMAE1 includes 2 simplex outlets, 6' power cord.
- Available in Black Only

PRODUCT CODE	PRICE	SIZE/INCHES			WEIGHT VOL	
		H	W	D	LBS	FT <sup>3</sup>
BEMAE1	255	2	3.625	3	2.5	0.149

**BRED50 • Duo Module**



- The duo power module is completely integrated with a mounting clamp to attach to the edge of a worksurface.
- Provides two outlets and two 2.1 amp USB ports.
- White face plate, outlets and bracket; 72" long three-prong cord.

PRODUCT CODE	PRICE	SIZE/INCHES			WEIGHT VOL	
		H	W	D	LBS	FT <sup>3</sup>
BRED50	841	1.8	5.5	3.2	2.50	0.14

**BRED50AC • Duo Module With A+C**



- The duo power module is completely integrated with a mounting clamp to attach to the edge of a worksurface.
- Provides two outlets and two 2.1 amp USB ports.
- White face plate, outlets and bracket; 72" long three-prong cord.

PRODUCT CODE	PRICE	SIZE/INCHES			WEIGHT VOL	
		H	W	D	LBS	FT <sup>3</sup>
BRED50ACW	695	3	5.5	3.2	3	0.2
BRED50ACB	695	3	5.5	3.2	3	0.2

**BREDU51 • Duo Under Module**

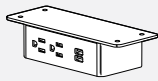

- The duo under power module comes with a thin flush mounting bracket to attach to the underside of a work surface or above work surface shelves.
- Provides two outlets and two 2.1 amp USB ports.
- White face plate, outlets and brackets; 72" long three-prong cord.

PRODUCT CODE	PRICE	SIZE/INCHES			WEIGHT VOL	
		H	W	D	LBS	FT <sup>3</sup>
BREDU51	736	1.8	5.5	2.8	2.5	0.14

**BREDU51 • Duo Under Module**



- The duo under power module comes with a thin flush mounting bracket to attach to the underside of a work surface or above work surface shelves.
- Provides two outlets and two 2.1 amp USB ports.
- White face plate, outlets and brackets; 72" long three-prong cord.

PRODUCT CODE	PRICE	SIZE/INCHES			WEIGHT VOL	
		H	W	D	LBS	FT <sup>3</sup>
BREDU51ACW	695	1.8	5.5	2.8	3	0.2
BREDU51ACB	695	1.8	5.5	2.8	3	0.2

**BREDB52 • Duo Bezel Module**

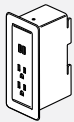

- The duo bezel power module is embedded and flush-mounted in a piece of furniture or a work surface.
- Provides two outlets and two 2.1 amp USB ports.
- White face plate, outlets and bezel; 72" long three-prong cord.
- Contact your Customer Service Representative for surface applications.

PRODUCT CODE	PRICE	SIZE/INCHES			WEIGHT VOL	
		H	W	D	LBS	FT <sup>3</sup>
BREDB52	789	4	6.5	3.2	2.5	0.14

**BRETP53 • Trio Plus Module**

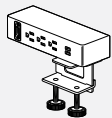

- The trio plus power module is completely integrated with a mounting clamp to attach to the edge of a work surface or above work surface shelves.
- Provides three outlets and two 2.1 amp USB ports and an adapter kit containing blank cover, HDMI, RJ45 or VGA adapter brackets. Note: HDMI, RJ45 and VGA connectors are not included.
- White face plate, outlets, adapters and brackets; 72" long three-prong cord.

PRODUCT CODE	PRICE	SIZE/INCHES			WEIGHT VOL	
		H	W	D	LBS	FT <sup>3</sup>
BRETP53	949	1.8	8	3.2	2.5	0.14

**BRETPB55 • Trio Plus Bezel Module**

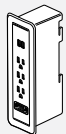

- The trio plus bezel power module is embedded and flush-mounted in a piece of furniture or a work surface.
- Provides three outlets and two 2.1 amp USB ports and an adapter kit containing blank cover, HDMI, RJ45 or VGA adapter brackets. Note: HDMI, RJ45 and VGA connectors are not included.
- White face plate, outlets, adapters and bezel; 72" long three-prong cord.
- Contact your Customer Service Representative for surface applications.

PRODUCT CODE	PRICE	SIZE/INCHES			WEIGHT VOL	
		H	W	D	LBS	FT <sup>3</sup>
BRETPB55	905	4	9	3.2	2.5	0.14

# D ACCESSORIES

## Telecom Plates

- Note: To be used in conjunction with BPGDPS21 and BPGDPS41.



PRODUCT CODE	PRICE
Black telecom plate with 2 RJ45 cat 6 data ABLBB	336

Black telecom plate with 3 RJ45 cat 6 data ABLBBB	493
--	-----

Black telecom plate with 4 RJ45 cat 6 data ABLBBBB	652
---	-----

## DABAR • Power Bar

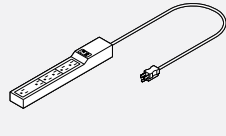

- Power bar with 5 + 1 receptacles (one spaced wide for adapter use), built-in transient voltage surge suppressor and power switch.
- Standard with 10' cord.
- Integrated key hole mounting in the back.
- Rating 15A, 125V, AC 60Hz, 1875W.
- Suppressed voltage rating: 330V peak.

PRODUCT CODE	PRICE	SIZE/INCHES			WEIGHT VOL	
		H	W	D	LBS	FT <sup>3</sup>
DABAR	85			12	2	0.02

## BABC • Wire Manager

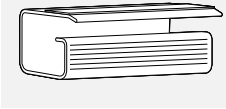

- Attaches to the underside of the worksurface with a peel and stick adhesive that is located on the top of the wire manager. Comes 10 per package.
- Black only

PRODUCT CODE	PRICE	SIZE/INCHES			WEIGHT VOL	
		H	W	D	LBS	FT <sup>3</sup>
BABC04	124	2	4	2	2	0.14

## BRACS • Cable Snake

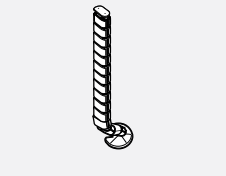

- Flexible cable management trough.
- Two pathways within the snake, one for data/communication and one for routing power cables.
- Clear (CLR) available only.

PRODUCT CODE	PRICE	SIZE/INCHES			WEIGHT VOL	
		H	W	D	LBS	FT <sup>3</sup>
BRACS	153	30	8		3	0.19
BRACSH	285	49	8		5	0.27

### MODPOWER POWER SOLUTION

- Power solutions for flexible spaces. Connect up to four units (in Canada)/six units in the USA from a single infeed with NEMA plug and deliver power and charging ports to the table top. In-surface modules and clamp on modules available.
- Easy to install; code compliant that allows users to optimize any space providing convenient power access. Perfect for training areas, meeting rooms, in-office workstations and more. Units feature tamper-resistant receptacles as well as both USB-A and USB-C charging ports.
- Easy to use connectors that are touch-safe with added latch to prevent unintended separation. Easy push together to connect, and simple press down on latch to disconnect.
- Maximum overall length not to exceed 48.5 feet per infeed. UL listed to UL962A SD, the standard for furniture power distribution units for portable/moveable work space tables.
- Certified to CSA standard C22.2 No. 203-16.
- Will work with Licence and Terina Products.
- Surface mounted module ships with a clamp mount that will accommodate any material 1/2" to 1-1/2" thick; additional brackets are also included for screw in mounting options that can accommodate vertical or horizontal positions.

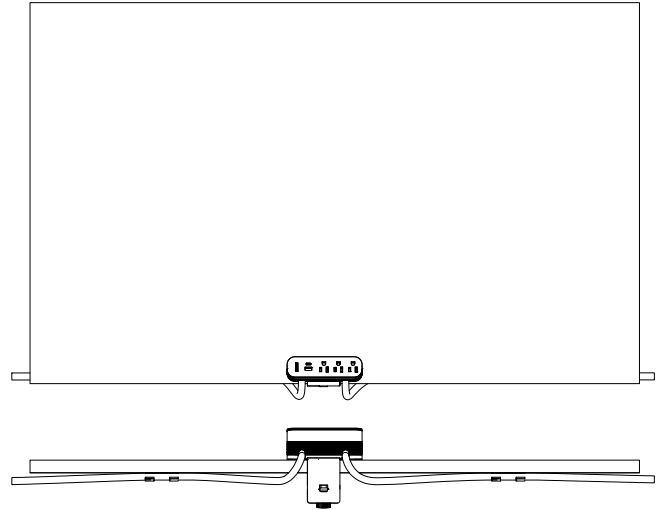
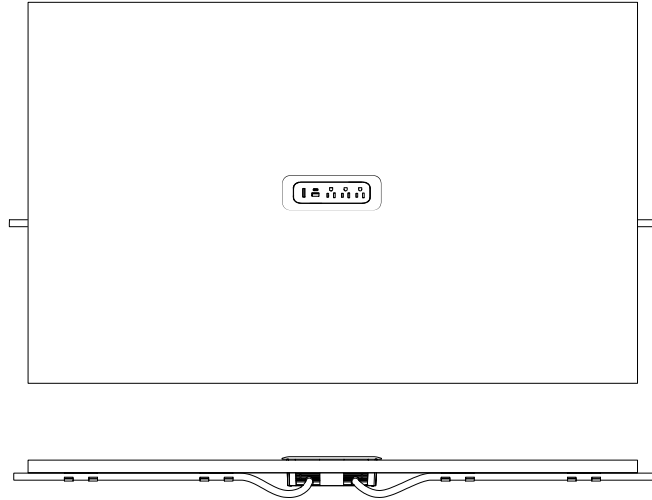
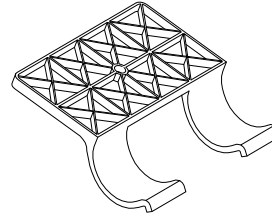

### GMDSF10 • ModPower in Surface Starter Unit

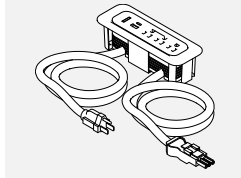

- ModPower starter unit includes one 10' cord with a NEMA plug and one 3' connector cord.
- Unit equipped with three 15A tamper resistant receptacles, one USB-A and one USB-C charging ports and a circuit breaker.
- 4 cable management cord clips included.
- MG at the end of the code indicates a magnesium finish, while WH is a white finish.

PRODUCT CODE	PRICE	SIZE / INCHES			WEIGHT LBS	VOL FT <sup>3</sup>
		H	W	D		
GMDSF10MG	1145	2.63	7.63	2.63	3.44	1.0
GMDSF10WH	1145	2.63	7.63	2.63	3.44	1.0

### GMDCF3 • ModPower in Surface Middle Unit

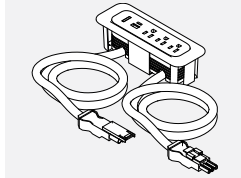

- ModPower middle unit includes two 3' connector cords.
- Unit equipped with three 15A rated 12A tamper resistant receptacles, one USB-A and one USB-C charging ports and a circuit breaker.
- 4 cable management cord clips included.
- MG at the end of the code indicates a magnesium finish, while WH is a white finish.

PRODUCT CODE	PRICE	SIZE / INCHES			WEIGHT LBS	VOL FT <sup>3</sup>
		H	W	D		
GMDCF3MG	1079	2.63	7.63	2.63	2.44	1.0
GMDCF3WH	1079	2.63	7.63	2.63	2.44	1.0

### GMDEF3 • ModPower in Surface End Unit

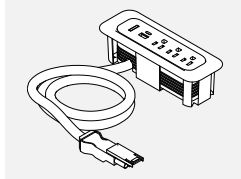

- ModPower end unit includes one 3' connector cord.
- Unit equipped with three 15A rated 12A tamper resistant receptacles, one USB-A and one USB-C charging ports and a circuit breaker.
- 2 cable management cord clips included.
- MG at the end of the code indicates a magnesium finish, while WH is a white finish.

PRODUCT CODE	PRICE	SIZE / INCHES			WEIGHT LBS	VOL FT <sup>3</sup>
		H	W	D		
GMDEF3MG	947	2.63	7.63	2.63	1.85	1.0
GMDEF3WH	947	2.63	7.63	2.63	1.85	1.0

**GMDSA10 • ModPower Starter-Mounted Unit**

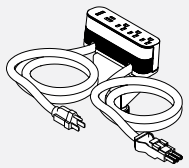

- ModPower starter unit includes one 10' cord with a NEMA plug and one 3' connector cord.
- Unit equipped with three 15A tamper resistant receptacles, one USB-A and one USB-C charging ports and a circuit breaker.
- Includes edge clamp and 3 other mounting methods; and 4 cable management cord clips.
- MG at the end of the code indicates a magnesium finish, while WH is a white finish.

PRODUCT CODE	PRICE	SIZE/INCHES			WEIGHT		VOL FT <sup>3</sup>
		H	W	D	LBS		
GMDSA10MG	1209	2.5	6.13	1.75	4.33	1.0	
GMDSA10WH	1209	2.5	6.13	1.75	4.33	1.0	

**GMDCA3 • ModPower Middle-Mounted Unit**

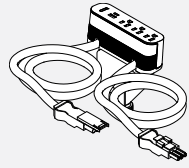

- ModPower middle unit includes two 3' connector cords.
- Unit equipped with three 15A rated 12A tamper resistant receptacles, one USB-A and one USB-C charging ports and a circuit breaker.
- Includes edge clamp and 3 other mounting methods; and 4 cable management cord clips.
- MG at the end of the code indicates a magnesium finish, while WH is a white finish.

PRODUCT CODE	PRICE	SIZE/INCHES			WEIGHT		VOL FT <sup>3</sup>
		H	W	D	LBS		
GMDCA3MG	1145	2.5	6.13	1.75	3.33	1.0	
GMDCA3WH	1145	2.5	6.13	1.75	3.33	1.0	

**GMDEA3 • ModPower End-Mounted Unit**

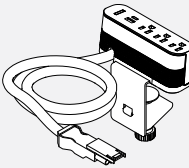

- ModPower end unit includes one 3' connector cord.
- Unit equipped with three 15A rated 12A tamper resistant receptacles, one USB-A and one USB-C charging ports and a circuit breaker.
- Includes edge clamp and 3 other mounting methods; and 2 cable management cord clips.
- MG at the end of the code indicates a magnesium finish, while WH is a white finish.

PRODUCT CODE	PRICE	SIZE/INCHES			WEIGHT		VOL FT <sup>3</sup>
		H	W	D	LBS		
GMDEA3MG	1013	2.5	6.13	1.75	2.75	1.0	
GMDEA3WH	1013	2.5	6.13	1.75	2.75	1.0	

**GMDCLIPS • ModPower Management Clips**

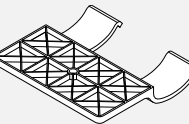

- Includes 10 clips.

PRODUCT CODE	PRICE	SIZE/INCHES			WEIGHT		VOL FT <sup>3</sup>
		H	W	D	LBS		
GMDCLIPS	196	0.6	2.6	2.5	0.3	0.2	

**GMDJ36BK • ModPower Interconnecting Jumper**

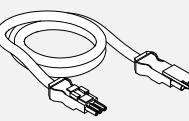

- ModPower interconnecting jumper cord to add an additional 3 feet of cord length between ModPower units.
- Package of 2, each 3 feet with male & female connector.

PRODUCT CODE	PRICE	SIZE/INCHES			WEIGHT		VOL FT <sup>3</sup>
		H	W	D	LBS		
GMDJ36BK	634		36		1.38	0.9	

**GMDPC22W • Slim Desktop Power Module, 2 Duplex**

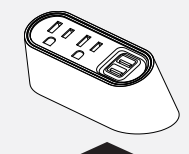

NEW!

- Desktop power center with two 15A tamper resistant power receptacles, one USB-A and one USB-C (provides 3.1A); 10' power cord.
- Includes three mounting options (i) a screw-in mounting plate for forward facing outlets; or (ii) an under surface mount bracket; or (iii) a clamp mounting kit for 0.5-1.5" thick surfaces.
- Gloss white body with grey face.

PRODUCT CODE	PRICE	SIZE/INCHES			WEIGHT		VOL FT <sup>3</sup>
		H	W	D	LBS		
GMDPC22W	741	2.25	4.88	2.25	2.5	0.5	

**GMDPC32W • Slim Desktop Power Module, 3 Duplex**

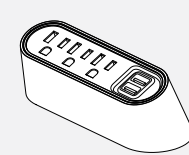

NEW!

- Desktop power center with three 15A tamper resistant power receptacles, one USB-A and one USB-C (provides 3.1A); 10' power cord.
- Includes three mounting options (i) a screw-in mounting plate for forward facing outlets; or (ii) an under surface mount bracket; or (iii) a clamp mounting kit for 0.5-1.5" thick surfaces.
- Gloss white body with grey face.

PRODUCT CODE	PRICE	SIZE/INCHES			WEIGHT		VOL FT <sup>3</sup>
		H	W	D	LBS		
GMDPC32W	968	2.25	6.00	2.25	2.6	0.5	

**BAVC • Vertical Wire Channel**



- PVC extrusion attaches to panel vertical to provide enclosure for a power or light cord.
- Available in 16" and 32" lengths, six per package.
- Can be cut to required lengths on site.
- Panel frame finish

PRODUCT CODE	PRICE	SIZE/INCHES			WEIGHT VOL	
		H	W	D	LBS	FT <sup>3</sup>
BAVC016	53		16		0.5	0.018
BAVC032	108		32		1.0	0.036

**BAR • Panel-Mounted Slotted Accessory Rail for Boulevard**

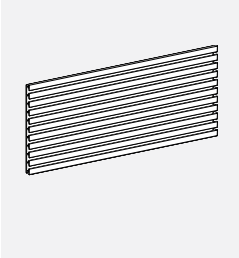

- Includes 10 horizontal slats for hanging capacity.
- Includes mounting hardware.
- Panel frame finish

**Hangs on standard Boulevard panels and accepts standard accessories.**

PRODUCT CODE	PRICE	SIZE/INCHES			WEIGHT VOL	
		H	W	D	LBS	FT <sup>3</sup>
BAR18	135	10.6	18	0.5	3	0.12
BAR24	150	10.6	24	0.5	4	0.17
BAR30	164	10.6	30	0.5	5	0.22
BAR36	178	10.6	36	0.5	6	0.26
BAR42	194	10.6	42	0.5	7	0.31
BAR48	209	10.6	48	0.5	8	0.35
BAR54	221	10.6	54	0.5	9	0.43
BAR60	237	10.6	60	0.5	10	0.49

**BALB • Panel-Mounted Load Bar for Boulevard**

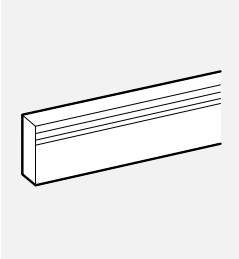

- Can be panel-mounted or wall mounted on rail
- (BHV01 or BHV02).
- Includes mounting brackets and end caps.
- Panel frame finish

PRODUCT CODE	PRICE	SIZE/INCHES			WEIGHT VOL	
		H	W	D	LBS	FT <sup>3</sup>
BALB18	108	3.5	18	0.75	2	0.031
BALB24	118	3.5	24	0.75	2	0.038
BALB30	130	3.5	30	0.75	3	0.048
BALB36	145	3.5	36	0.75	3	0.057
BALB42	166	3.5	42	0.75	4	0.067
BALB48	190	3.5	48	0.75	4	0.076
BALB54	209	3.5	54	0.75	5	0.086
BALB60	220	3.5	60	0.75	5	0.096

**BADLB • Panel-Mounted Accessory Rail for Boulevard**

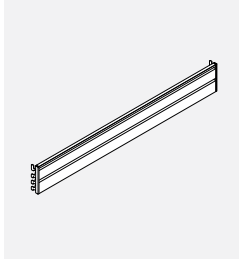

Enables accessory items to be hung from a panel.  
Includes end caps and mounting brackets.

PRODUCT CODE	PRICE	SIZE/INCHES			WEIGHT VOL	
		H	W	D	LBS	FT <sup>3</sup>
BADLB18	204	4.23	18	1.53	2.34	0.07
BADLB24	215	4.23	24	1.53	2.88	0.09
BADLB30	227	4.23	30	1.53	3.42	0.11
BADLB36	241	4.23	36	1.53	3.97	0.13
BADLB42	253	4.23	42	1.53	4.51	0.16
BADLB48	266	4.23	48	1.53	5.05	0.18
BADLB54	279	4.23	54	1.53	5.59	0.20
BADLB60	288	4.23	60	1.53	6.13	0.22

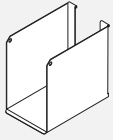
**BABB01 • Binder Bin**

- Load bar/accessory rail mounted metal binder bin.
- Panel frame finish

PRODUCT CODE	PRICE	SIZE/INCHES			WEIGHT VOL	
		H	W	D	LBS	FT <sup>3</sup>
BABB01	93	9	5.75	9.25	1.85	0.21

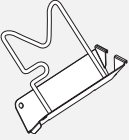
**BAFS01 • Flip Sorter**

- Load bar/accessory rail mounted metal flip sorter. Comes with chrome wire.
- Panel frame finish

PRODUCT CODE	PRICE	SIZE/INCHES			WEIGHT VOL	
		H	W	D	LBS	FT <sup>3</sup>
BAFS01	88	9	3	9	0.6	0.14

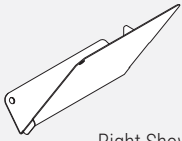
**BASS01 • Slant Sorter**

Right Shown

- • Load bar/accessory rail mounted metal slant sorter.
- • Panel frame finish

PRODUCT CODE	PRICE	SIZE/INCHES			WEIGHT VOL	
		H	W	D	LBS	FT <sup>3</sup>
BASS01R	59	9.25	2.75	9	1	0.28
BASS01L	59	9.25	2.75	9	1	0.28

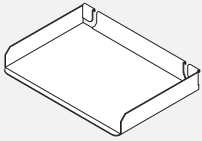
**BALT • Letter Tray/Legal Tray**

- Load bar/accessory rail mounted metal letter or legal tray.
- Panel frame finish

PRODUCT CODE	PRICE	SIZE/INCHES			WEIGHT VOL	
		H	W	D	LBS	FT <sup>3</sup>
BALT01	68	1.75	12	8.75	0.5	0.15
BALT01LGL	108	1.75	14.7	8.75	0.5	0.15

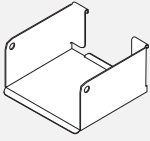
**BAMB01 • Media Bin**

- Load bar/accessory rail mounted metal media bin.
- Panel frame finish

PRODUCT CODE	PRICE	SIZE/INCHES			WEIGHT VOL	
		H	W	D	LBS	FT <sup>3</sup>
BAMB01	82	3	5.75	5.25	0.8	0.05

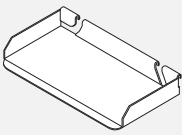
**BAUT01 • Utility Tray**

- Load bar/accessory rail mounted metal utility tray.
- Panel frame finish

PRODUCT CODE	PRICE	SIZE/INCHES			WEIGHT VOL	
		H	W	D	LBS	FT <sup>3</sup>
BAUT01	59	1	7.5	4	0.5	0.02

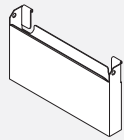
**BAPP01 • Mail Box**

- Freestanding unit or load bar/accessory rail mounted.
- Panel frame finish

PRODUCT CODE	PRICE	SIZE/INCHES			WEIGHT VOL	
		H	W	D	LBS	FT <sup>3</sup>
BAPP01	90	7	12	1.75	2	0.25

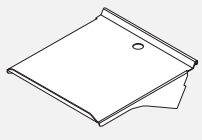
**BATH01 • Telephone Holder**

- Load bar/rail mounted telephone holder.
- Panel frame finish

PRODUCT CODE	PRICE	SIZE/INCHES			WEIGHT VOL	
		H	W	D	LBS	FT <sup>3</sup>
BATH01	131	2	8	10	2	0.26



**BAPD • Pencil Drawer**

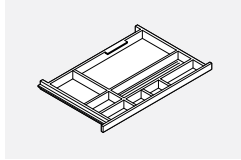

- Provides accommodation for writing instruments and small items at the workspace.
- Attaches to the underside of worksurface with drawer slides.
- Available in Black ABS Only

PRODUCT CODE	PRICE	SIZE/INCHES			WEIGHT VOL	
		H	W	D	LBS	FT <sup>3</sup>
BAPD2015	118	1.5	22.5	17.75	2	0.300

**BAHO • Coat Hook**

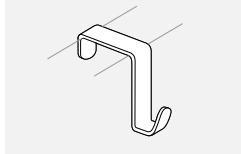

- Over the panel-mounted coat hook for Boulevard 1 panels only. Priced six per package.
- Panel Frame Finish

PRODUCT CODE	PRICE	SIZE/INCHES			WEIGHT VOL	
		H	W	D	LBS	FT <sup>3</sup>
BAHO3080	55	3	1	3	0.2	0.001

**BAHB3CH • Coat Hook for System 3**

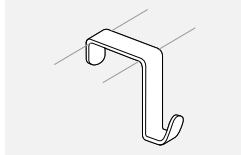

- Over the panel-mounted coat hook for Boulevard, System 3 panels or Boulevard 1 panels with top trim. Priced six per package.
- Panel Frame Finish

PRODUCT CODE	PRICE	SIZE/INCHES			WEIGHT VOL	
		H	W	D	LBS	FT <sup>3</sup>
BAHB3CH	103	3	1	3	0.2	0.001

**DAHOCH • Coat Hook for Diet**

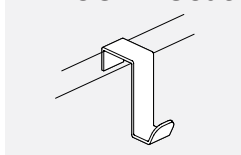

- Panel-mounted coat hook Diet Panels.
- Panel Frame Finish

PRODUCT CODE	PRICE	SIZE/INCHES			WEIGHT VOL	
		H	W	D	LBS	FT <sup>3</sup>
DAHOCH	28	3	0.75	3	0.2	0.001

**BPNP • Boulevard Name Plate**

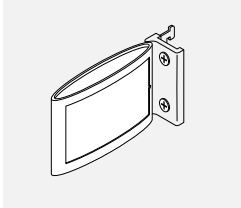

- Name plate attaches to 1" increment slots of Boulevard. It can be set either as a single-sided (parallel to panel surface) or double-sided (perpendicular to panel surface - for aisle applications, displaying name on both sides).
- Injection molded frame and die-cast base with black rubberized finish. Steel bracket and fasteners included
- Includes two slide-in name cards.

PRODUCT CODE	PRICE	SIZE/INCHES			WEIGHT VOL	
		H	W	D	LBS	FT <sup>3</sup>
BPNP01	112	3.3	5.3	1.25	0.3	0.013

**DPN01 • Diet Name Plate**

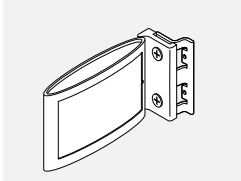

- Name plate can be set either as a single-sided (parallel to panel surface) or double-sided (perpendicular to panel surface - for aisle applications, displaying name on both sides).
- Injection molded frame and die-cast base with black rubberized finish. Steel bracket and fasteners included.
- Includes two slide-in name cards.

PRODUCT CODE	PRICE	SIZE/INCHES			WEIGHT VOL	
		H	W	D	LBS	FT <sup>3</sup>
DPNP01	112	3.3	5.3	1.25	0.3	0.013

**BHTPO1 • Bracket to Connect Licence Towers to Boulevard Panels**

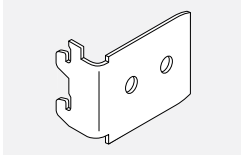

- Panel Frame Finish

PRODUCT CODE	PRICE	SIZE/INCHES			WEIGHT VOL	
		H	W	D	LBS	FT <sup>3</sup>
BHTPO1	71	2	2.5	1	2	0.05

# D ACCESSORIES

## BATB • Fabric Tackboard for Boulevard

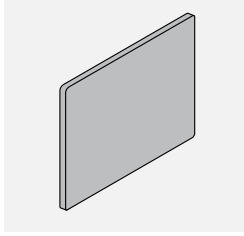

- To provide a tackable surface for notes and memos in a work area. Panel-mounted.
- Includes mounting brackets.
- Class "A" Fire Rated Fabric.

PRODUCT CODE	PRICE		SIZE / INCHES			WEIGHT VOL	
	GR1	GR2	H	W	D	LBS	FT <sup>3</sup>
BATB2430	252	263	24	30		3	0.416
BATB2436	287	299	24	36		4	0.500
BATB2442	328	339	24	42		4	0.583
BATB2448	367	393	24	48		5	0.666
BATB2454	406	432	24	54		5	0.750
BATB2460	444	473	24	60		6	0.833
BATB2472	540	592	24	72		6	0.999

## BAWB • Write Board for Boulevard

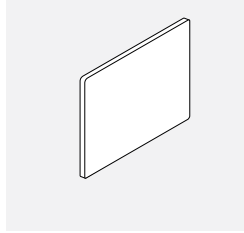

- To provide a writing surface in a work area. Panel-mounted.
- Includes mounting brackets.
- Black Trim Only

PRODUCT CODE	PRICE	SIZE / INCHES			WEIGHT VOL	
		H	W	D	LBS	FT <sup>3</sup>
BAWB2436	408	24	36		13	0.500
BAWB2442	470	24	42		15	0.583
BAWB2448	539	24	48		18	0.666

## BAMT12 • Marker Tray

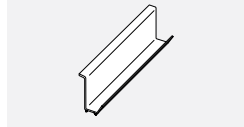

PRODUCT CODE	PRICE	SIZE / INCHES			WEIGHT VOL	
		H	W	D	LBS	FT <sup>3</sup>
BAMT12	91		12		0.5	0.01

## BATP • Touch-Up Paint Kit

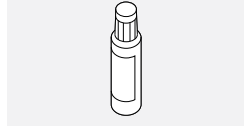

- Paint to match panel frame colors for easy touch ups. 1/2oz. (15ml) bottle

PRODUCT CODE	PRICE	SIZE / INCHES			WEIGHT VOL	
		H	W	D	LBS	FT <sup>3</sup>
BATP91	49				0.41	0.1

## LICENCE 2 SPECIFICATIONS

- Greenguard certified ([www.greenguard.org](http://www.greenguard.org))
- Carb compliant
- Level3™ certified ([www.levelcertified.org](http://www.levelcertified.org))
- Tested to meet or exceed ANSI/BIFMA X5.9.2004 , ANSI/BIFMA X5.5.2008 and CAN/CGSB 44-227-2008
- Plant is ISO 9001:2015 (Quality) certified
- Plant is ISO 14001: 2015 (Environmental) certified
- Plant is OHSAS 18001:2007 (Health and Safety) certified
- 100% made in Canada
- Lifetime Warranty
- Over 6500 standard components
- Custom units available in 5 weeks lead time
- Over 24 standard laminate finishes available
- Edge color can be specified - select from 20 colors and patterns
- Desk shells and rectangular returns non handed
- Panel end style with top over side panel design
- Tops available in 1" thick Low Pressure Laminate
- Tops available in 1-1/16" or 1-7/16" thick High Pressure Laminate
- Tops available in one edge style: Boulevard (S)
- Surfaces constructed of 45lb. density particleboard substructure with high performance thermally fused laminate or optional high pressure laminate
- Chassis constructed from 45lb. density particleboard substructure with thermally fused laminate
- 3mm edges surround all tops, end panels, drawers and door fronts
- Laminate full modesty and 10" partial modesty available as standard
- Anodized Aluminum framed frosted glazed doors available, no handles included.
- Box drawers mounted on full extension premium ball bearing slides
- File drawers mounted on premium full extension progressive ball bearing slides
- File drawers accommodate letter and/or legal hanging files (see file drawer capacity page G.2)
- Locks are standard on all units. Available in black or silver finish
- All lateral files feature a drawer interlocking mechanism
- Desk drawers open with pulls as standard
- Drawer bottoms are routed into the drawer sides
- Drawer fronts are edged on all four sides with matching 3mm edge
- All drawers locking as standard
- Key alike available
- Pedestals available in 15-1/2" width and 18, 20, 23, 24, 29, 30, 36 depth, include one pencil tray
- All mobile pedestals have option for a counterweight
- Storage modules feature levellers 5/16" x 1" easily accessible from outside the unit. All others feature 5/16" x 2" levellers.
- Monopost legs available in 3 different options, 2.5" or 3" square, 3" round and 6" round
- 6 handle options
- Storage modules available in 4 heights 29", 50", 65.8", 72.8"
- Lateral modules available in 3 widths 30", 36", 42"
- Rectangular grommets are standard and can be specified in a variety of locations as standard (see Grommet Location page A.10)
- Several Power Grommets style and configurations available.
- Drawers/Door fronts are available in a different finish than that of the chassis. Please specify option. Note that the kick plate will match the drawer front finish unless otherwise noted.

## FREESTANDING - TECHNICAL INFORMATION

### Worksurfaces

Worksurfaces are offered in LP (1"), B (1 1/16") or W (1 7/16").

All worksurfaces are drilled to accept connectors in a desk configuration.



Worksurfaces are available in the following shapes: rectangular, bow, wedge and swerve.

### Worksurface Edge trim

Available in 1 1/16" ("B" thickness), 1 7/16" ("W" thickness) or 1" ("LP" thickness).

Wood grain PVC edge trim, available in Boulevard (S) edge "B" and "W" thickness only.

### Edge Options

	Boulevard (S) Edge	
"LP" Thickness		1"
HP "B" Thickness		1 1/16"
HP "W" Thickness		1 7/16"

### Hardware

All attachment hardware is included.

### Modesty Panels

Available in full panel 27 5/8" high or half panel ("H" option) 10" high. Modesty panels are flush mounted with 24", 30" and 36" deep end gables. Modesty panels are available recessed for 30" and 36" deep end gables. All recessed modesty panels are inset 6" from the edge. Only flush modesty panels are used for extended shell and bridge. Only full modesty panels are used for "L2D" desks: Rectangular, Bow, and Wedge worksurfaces. All exposed edges are edge banded.

### Panel and Gables

The term "end gable" or "narrow gable" is used to configure a shell, single pedestal or return.

The term "end panel" or "narrow panel" is used to configure a table desk with shaped worksurfaces such as "D", "P", or profiles.

All end gables are interchangeable for left or right hand use. End gables 24", 30" and 36" deep are drilled to accept full or half modesty panels that are flush mounted.

End gables 30" and 36" are used for full or half modesty panels that are recessed. All panels and end gables are 1" thick and 27 5/8" high.

All panels and end gables are finished in low pressure laminate.

End gables are used in shells and single pedestal desks.

Narrow end gables are used in shells, single pedestal desks, "T", or "L" bases.

Narrow panels are routed to accept modular connectors for "T" or "L" applications.

All panels and gables are predrilled to accept levelers at the bottom and connectors at the top.

All panels or gables are 3mm edge banded at the exposed edge .

All narrow gables are routed at the top to allow cables to pass through and come with a connecting flat bracket.

All bottom edges are edge banded.

### Handles

Handles are offered in 4 styles.

Options are as follows: BB = Bow Matte Black

BC = Bow Matte Chrome

UB = "U"Dull Black

UC = "U"Dull Chrome

FA = Flat Aluminum

RN = Round Nickel

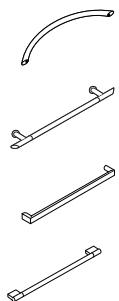

Span dimension between drilling locations is 192mm. e-lock

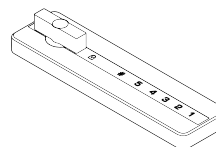

WOOD GRAIN (WG) LAMINATE DIRECTION

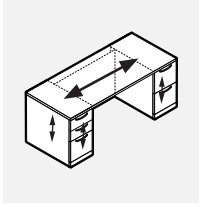

Double Pedestal Desks

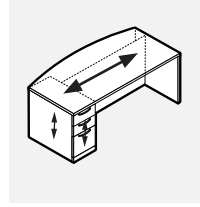

Single Pedestal Desks

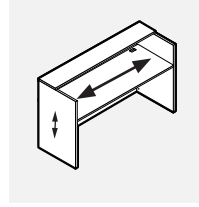

Reception Desks

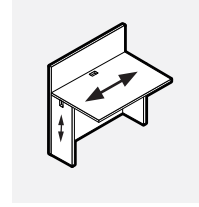

Surround Bridge

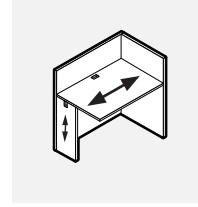

Right Hand Surround Bridge

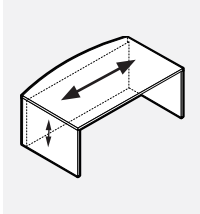

Shells

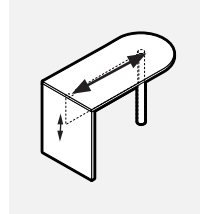

D-Shaped Tables

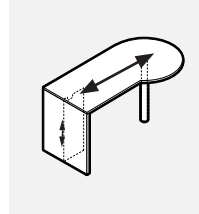

P-Shaped Tables

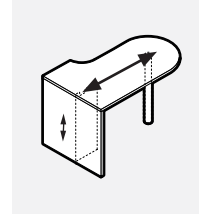

Profile Corner Round Tables

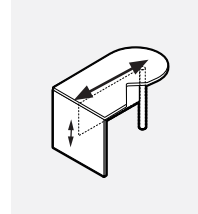

Profile Corner Cut Tables

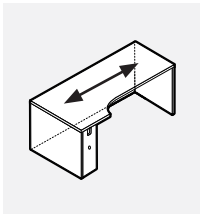

Profile Corner Desks

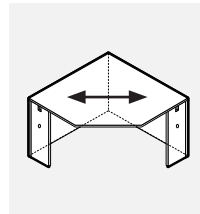

All Corner Desks 42" and Smaller

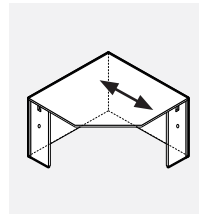

All Corner Desks Larger than 42"

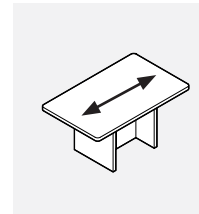

Occasional Tables

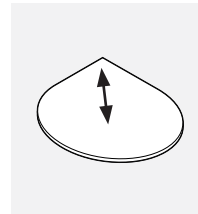

Teardrop Table Tops

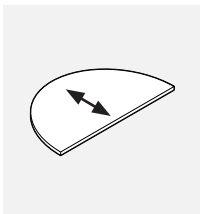

Half Moon Table Tops

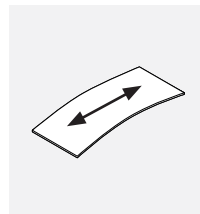

All Other Table Tops

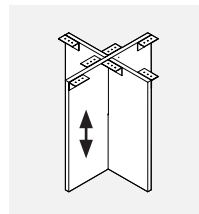

Bases

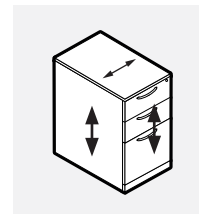

All Pedestals

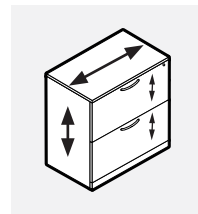

All Laterals

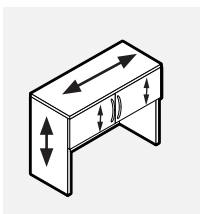

All Hinged Door Hutches

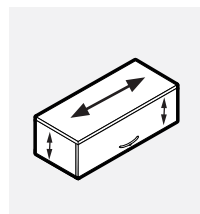

All Flip-Up Door Overheads

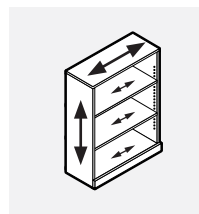

All Bookcases

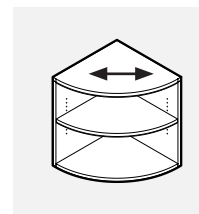

All Corner Bookcases

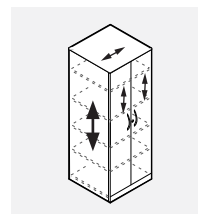

All Towers

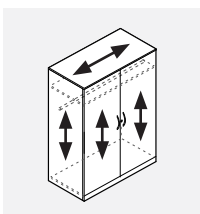

All Cabinets

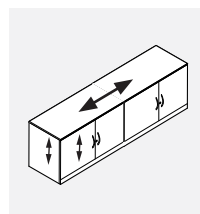

All Credenzas

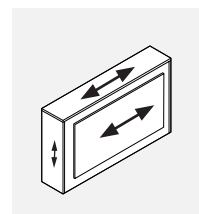

Gallery Desk

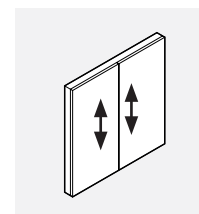

Visual Board

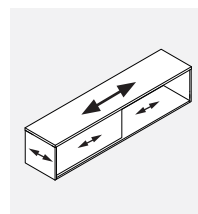

Overhead Divider Storage

## GROMMET LOCATION

### Notes

All workspaces are standard with rectangular grommets # BG5.  
 Worksurfaces 54" wide and under are standard with 1 grommet.  
 Worksurfaces over 54" wide are standard with 2 grommets.

Grommet location must be specified at time of order or it will default to "no grommet" option.

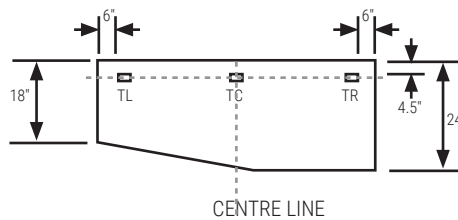
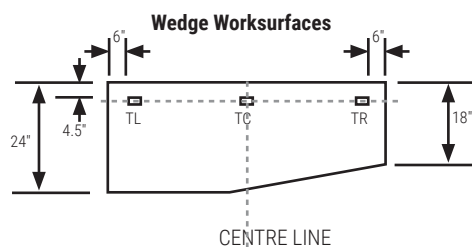
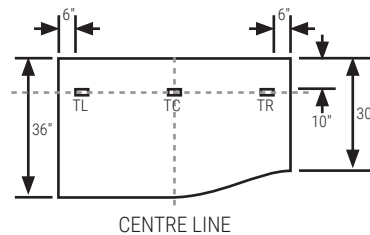
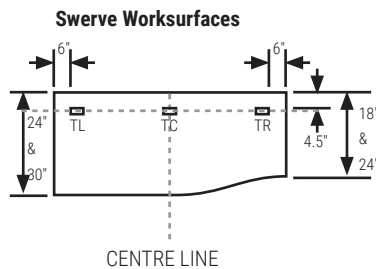
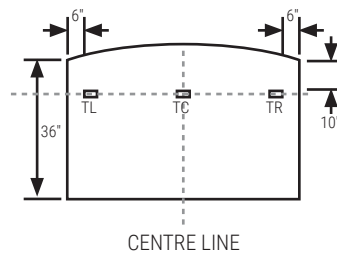
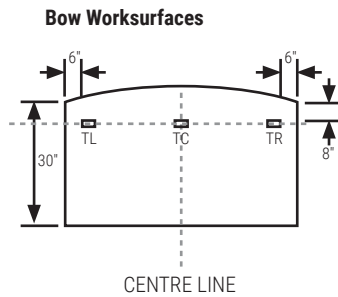
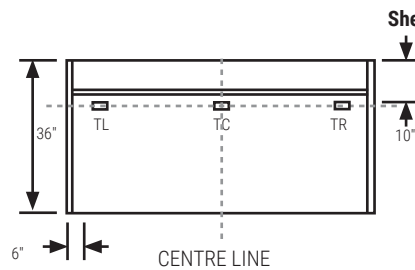
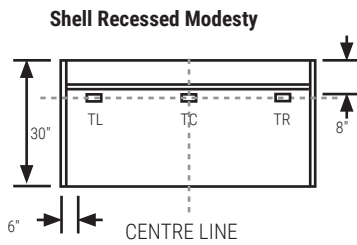
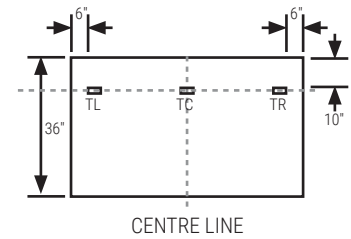
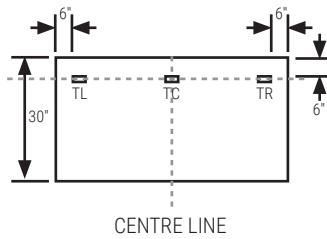
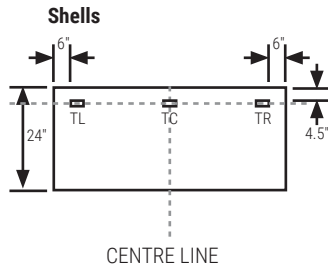
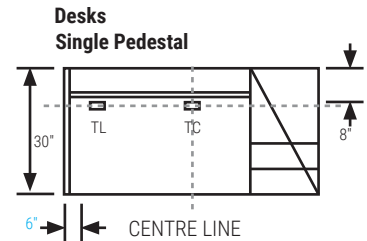
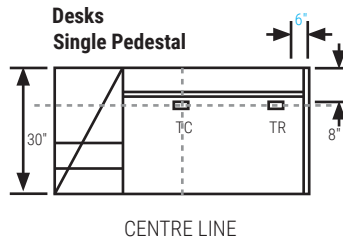
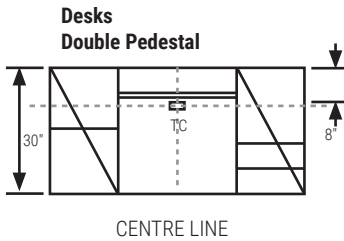

**GROMMET LOCATION**

**P-Shaped Tables "L2T"**

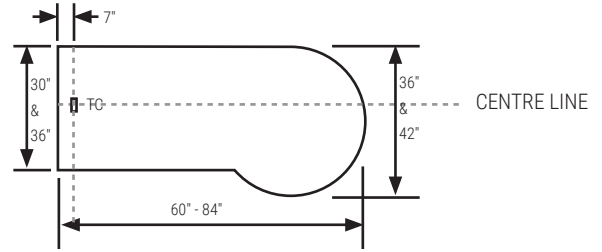
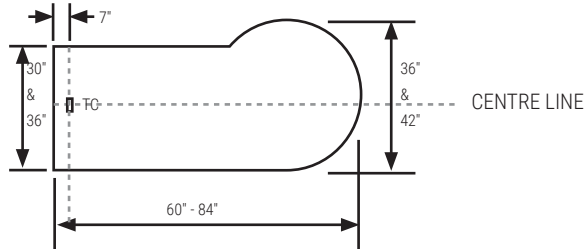

**Extended "D" - L2TED**

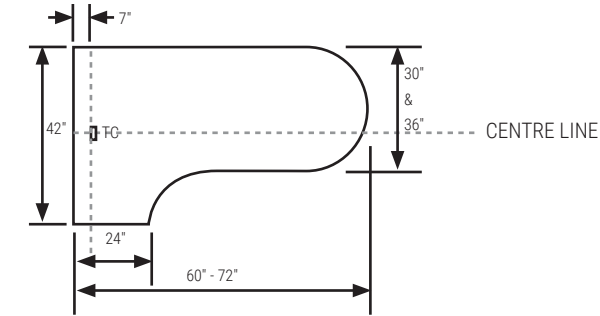

**D-Shaped Tables**

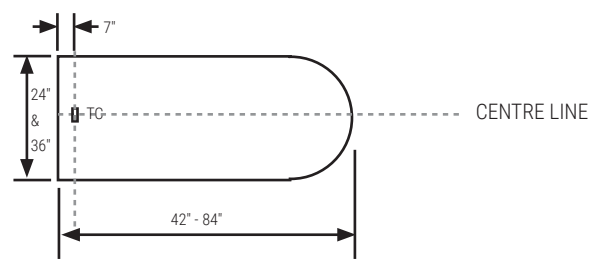

**Extended Corner "L2EC"**

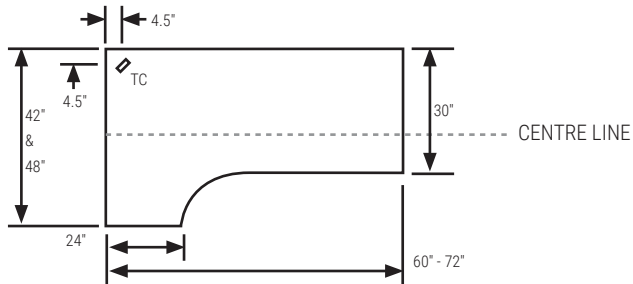

**Extended "D" Cut Out "L2TEDCO"**

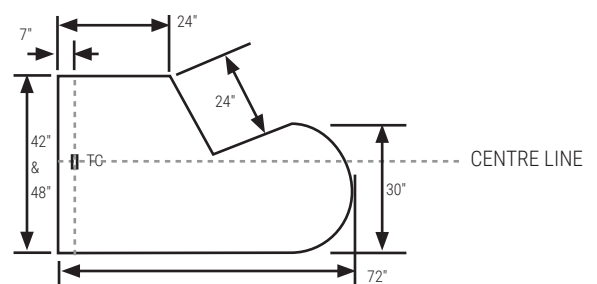

**Extended Corner Recessed Modesty**

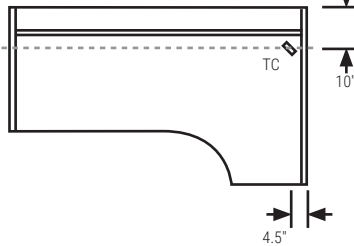

**Wedge Shell Recessed Modesty**

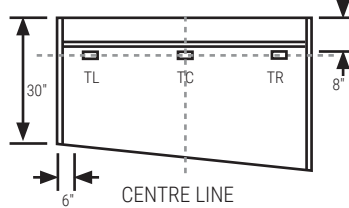

**Corner Worksurfaces - 1 Piece**

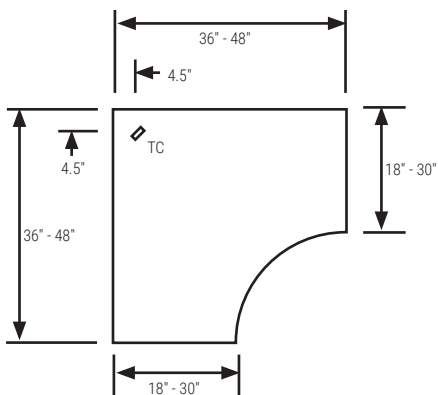

**Split Corner Worksurfaces - 2-Piece**

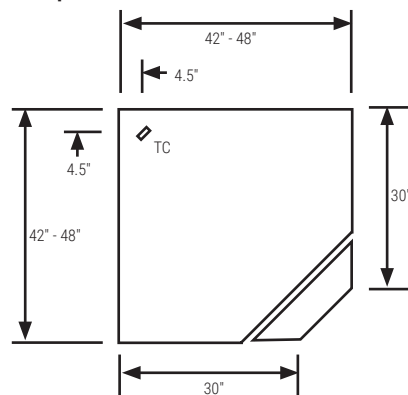

## GROMMET LOCATION

### Hockey-Shaped Tables "L2TH"



### Floating Tops "L2F"

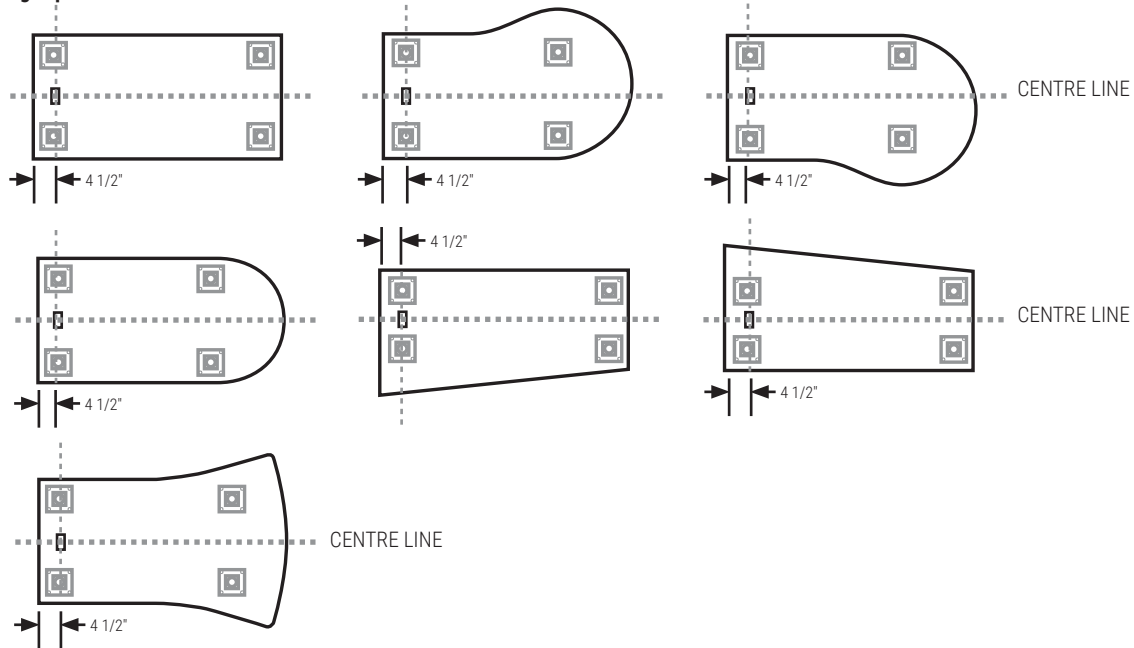

### Runoff Tops "L2TC"

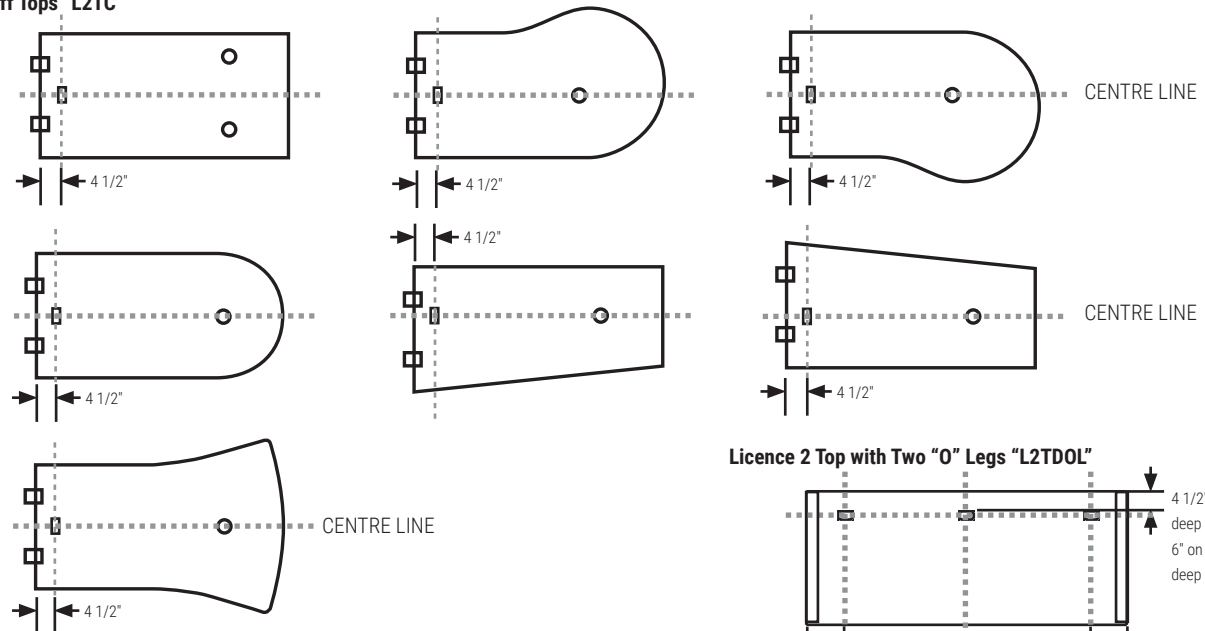

### Floating Tops "L2FFL"

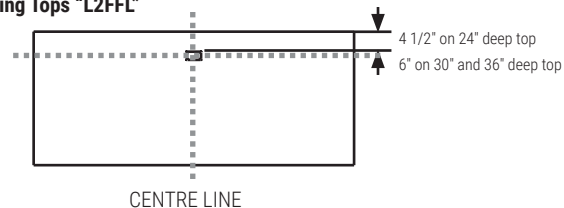

### Licence 2 Top with Two "O" Legs "L2TDOL"

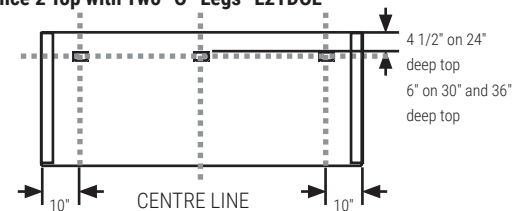

**TECHNICAL INFORMATION**

**Double Pedestal Desk/ Single Pedestal Desk**

- All desks are Shipped knocked down (KD).
- Pedestals are shipped assembled
- Pedestals are LP all over
- Non Interlocking mechanism Pedestals
- Half modesty available on all Double Pedestal Desks, specify 'H' Before size eg. L2DRH3060FB
- Half modesty available on Single Pedestal Desks, specify "H" before size eg. L2DRH3060BR
- All desks have modesty recessed 6"

**Executive Return Desk**

- All desks are Shipped knocked down (KD).
- This typed of desk must be connected at open end to adjoining worksurface with flat brackets.
- Half modesty available on all Single Pedestal Returns, specify "H" before size eg. L2RH2036FL

**Single Pedestal Returns**

- All desks are Shipped knocked down (KD).
- This type of desk must be connected at open end to adjoining worksurface with flat brackets.

**DESKS • GUIDELINES FOR ORDERING PRODUCT**

**CODES:** The price list uses a numbering system with meaningful alphanumeric characters to create a simple-to-understand product number. This makes specifying the product much easier and more accurate.

**SPECIFICATION EXAMPLE OF A DESK UNIT**

**PRODUCT CODE:** L2DR3060FB  
 L2 = New Licence  
 D = Desk  
 R = Rectangular  
 3060 = Size: Depth x Width  
 FB = PED FF LEFT / PED BBF RIGHT

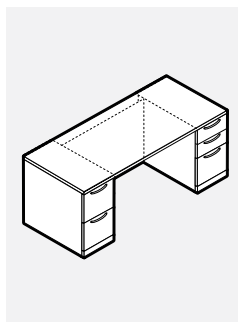

**OPTIONS:**  
 Top: LP - LP (Low Pressure Laminate) Thickness 1"  
 HP B - B Thickness 1 1/16"  
 HP W - W Thickness 1 7/16"

Top Finish Laminate: Choose Color

Top PVC Edging: Choose Color

Chassis Laminate: Choose Color

Chassis PVC Edging: Choose Color

Handle Style: **BC - Bow Matte Chrome (DEFAULT)**  
 BB - Bow Matt Black  
 UB - "U" Dull Black  
 UC - "U" Dull Chrome  
 FA - Flat Aluminum  
 RN - Round Nickel

Grommet Location: **N - No grommet (DEFAULT)**  
 Double Pedestal desk: TC - Top Center Only  
 Single Right Pedestal Desk: TC - Top Center  
 TL - Top Left  
 Single Left Pedestal Desk: TC - Top Center  
 TR - Top Right

**L2 • Keys**

PRODUCT CODE	PRICE	SIZE/ INCHES		WEIGHT LBS	VOL FT <sup>3</sup>
		H	W D		
<b>Master key:</b> L2MK	29				
<b>Extra key for existing cabinet:</b> L2EK	11				
<b>Core key:</b> L2CK	12				
<b>Core &amp; Key:</b> L2LOCKKEY	33				

- Additional key (specify at time of order).
- Please choose black or silver.



**L2DR-FB • Double Pedestal Desk, File/File Left, Box/Box/File Right, Recessed Modesty**

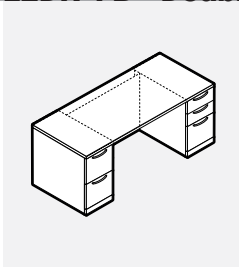

• Optional e-lock available for each pedestal in the vertical position. Please specify V - Vertical and add \$304 list for each.

PRODUCT CODE	FINISH LP	B	W	SIZE/INCHES				WEIGHT LBS	VOL FT <sup>3</sup>
				H (LP/B)	H (W)	W	D		
L2DR3060FB	2942	3115	3274	29	29.5	60	30	224	24
L2DR3066FB	2995	3186	3361	29	29.5	66	30	234	25
L2DR3072FB	3049	3258	3448	29	29.5	72	30	244	25
L2DR3078FB	3105	3330	3534	29	29.5	78	30	272	26
L2DR3084FB	3164	3406	3626	29	29.5	84	30	299	26
L2DR3672FB	3207	3458	3672	29	29.5	72	36	272	26
L2DR3678FB	3265	3539	3771	29	29.5	78	36	299	28
L2DR3684FB	3330	3611	3871	29	29.5	84	36	327	28

**L2DR-BF • Double Pedestal Desk, Box/Box/File Left, File/File Right, Recessed Modesty**

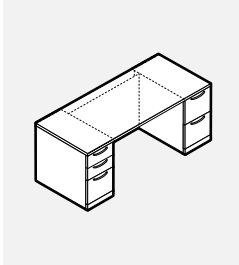

• Optional e-lock available for each pedestal in the vertical position. Please specify V - Vertical and add \$304 list for each.

PRODUCT CODE	FINISH LP	B	W	SIZE/INCHES				WEIGHT LBS	VOL FT <sup>3</sup>
				H (LP/B)	H (W)	W	D		
L2DR3060BF	2942	3115	3274	29	29.5	60	30	224	24
L2DR3066BF	2995	3186	3361	29	29.5	66	30	234	25
L2DR3072BF	3049	3258	3448	29	29.5	72	30	244	25
L2DR3078BF	3105	3330	3534	29	29.5	78	30	272	26
L2DR3084BF	3164	3406	3626	29	29.5	84	30	299	26
L2DR3672BF	3207	3458	3672	29	29.5	72	36	272	26
L2DR3678BF	3265	3539	3771	29	29.5	78	36	299	28
L2DR3684BF	3330	3611	3871	29	29.5	84	36	327	28

**L2DRH-FB • Double Pedestal Desk, File/File Left, Box/Box/File Right Recessed Half Modesty**

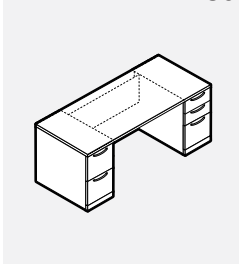

• Optional e-lock available for each pedestal in the vertical position. Please specify V - Vertical and add \$304 list for each.

PRODUCT CODE	FINISH LP	B	W	SIZE/INCHES				WEIGHT LBS	VOL FT <sup>3</sup>
				H (LP/B)	H (W)	W	D		
L2DRH3060FB	2871	3044	3206	29	29.5	60	30	224	24
L2DRH3066FB	2914	3104	3278	29	29.5	66	30	234	25
L2DRH3072FB	2954	3162	3352	29	29.5	72	30	244	25
L2DRH3078FB	2996	3220	3426	29	29.5	78	30	272	26
L2DRH3084FB	3042	3286	3503	29	29.5	84	30	299	26
L2DRH3672FB	3112	3361	3577	29	29.5	72	36	272	26
L2DRH3678FB	3158	3427	3660	29	29.5	78	36	299	28
L2DRH3684FB	3210	3502	3749	29	29.5	84	36	327	28

**L2DRH-BF • Double Pedestal Desk, Box/Box/File Left, File/File Right Recessed Half Modesty**

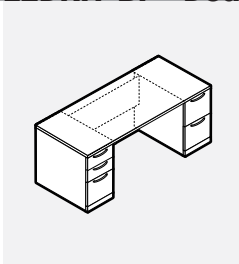

• Optional e-lock available for each pedestal in the vertical position. Please specify V - Vertical and add \$304 list for each.

PRODUCT CODE	FINISH LP	B	W	SIZE/INCHES				WEIGHT LBS	VOL FT <sup>3</sup>
				H (LP/B)	H (W)	W	D		
L2DRH3060BF	2871	3044	3206	29	29.5	60	30	224	24
L2DRH3066BF	2914	3104	3278	29	29.5	66	30	234	25
L2DRH3072BF	2954	3162	3352	29	29.5	72	30	244	25
L2DRH3078BF	2996	3220	3426	29	29.5	78	30	272	26
L2DRH3084BF	3042	3286	3503	29	29.5	84	30	299	26
L2DRH3672BF	3112	3361	3577	29	29.5	72	36	272	26
L2DRH3678BF	3158	3427	3660	29	29.5	78	36	299	28
L2DRH3684BF	3210	3502	3749	29	29.5	84	36	327	28

**L2DB-FB • Bowfront Double Pedestal Desk, File/File Left, Box/Box/File Right, Recessed Modesty**

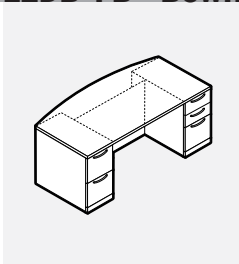

• Optional e-lock available for each pedestal in the vertical position. Please specify V - Vertical and add \$304 list for each.

PRODUCT CODE	FINISH LP	B	W	SIZE/INCHES				WEIGHT LBS	VOL FT <sup>3</sup>
				H (LP/B)	H (W)	W	D		
L2DB3060FB	3007	3215	3399	29	29.5	60	36	374	25
L2DB3066FB	3071	3298	3493	29	29.5	66	36	383	26
L2DB3072FB	3129	3378	3589	29	29.5	72	36	395	26
L2DB3078FB	3191	3460	3683	29	29.5	78	36	422	28
L2DB3084FB	3253	3544	3784	29	29.5	84	36	450	28
L2DB3672FB	3287	3577	3812	29	29.5	72	42	422	28
L2DB3678FB	3352	3666	3918	29	29.5	78	42	450	29
L2DB3684FB	3420	3758	4028	29	29.5	84	42	477	29

**L2DB-BF • Bowfront Double Pedestal Desk, File/File Right, Box/Box/File Left, Recessed Modesty**

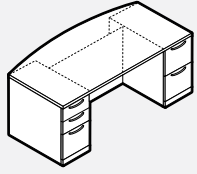

• Optional e-lock available for each pedestal in the vertical position. Please specify V - Vertical and add \$304 list for each.

PRODUCT CODE	FINISH LP	B	W	SIZE / INCHES				WEIGHT LBS	VOL FT <sup>3</sup>
				H(LP/B)	H(W)	W	D		
L2DB3060BF	3007	3215	3399	29	29.5	60	36	374	25
L2DB3066BF	3071	3298	3493	29	29.5	66	36	383	26
L2DB3072BF	3129	3378	3589	29	29.5	72	36	395	26
L2DB3078BF	3191	3460	3683	29	29.5	78	36	422	28
L2DB3084BF	3253	3544	3784	29	29.5	84	36	450	28
L2DB3672BF	3287	3577	3812	29	29.5	72	42	422	28
L2DB3678BF	3352	3666	3918	29	29.5	78	42	450	29
L2DB3684BF	3420	3758	4028	29	29.5	84	42	477	29

**L2DBH-FB • Bowfront Double Pedestal Desk, File/File Left, Box/Box/File Right Recessed Half Modesty**

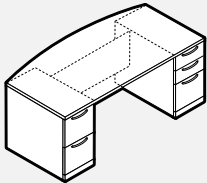

• Optional e-lock available for each pedestal in the vertical position. Please specify V - Vertical and add \$304 list for each.

PRODUCT CODE	FINISH LP	B	W	SIZE / INCHES				WEIGHT LBS	VOL FT <sup>3</sup>
				H(LP/B)	H(W)	W	D		
L2DBH3060FB	2942	3150	3328	29	29.5	60	36	374	25
L2DBH3066FB	2988	3215	3411	29	29.5	66	36	383	26
L2DBH3072FB	3034	3282	3493	29	29.5	72	36	395	26
L2DBH3078FB	3080	3352	3575	29	29.5	78	36	422	28
L2DBH3084FB	3131	3422	3663	29	29.5	84	36	450	28
L2DBH3672FB	3191	3481	3717	29	29.5	72	42	422	28
L2DBH3678FB	3242	3558	3807	29	29.5	78	42	450	29
L2DBH3684FB	3299	3637	3907	29	29.5	84	42	477	29

**L2DBH-BF • Bowfront Double Pedestal Desk, Box/Box/File Left, File/File Right Recessed Half Modesty**

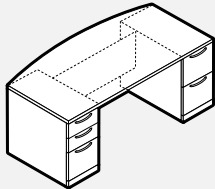

• Optional e-lock available for the pedestal in the vertical position. Please specify V - Vertical and add \$304 list for each.

PRODUCT CODE	FINISH LP	B	W	SIZE / INCHES				WEIGHT LBS	VOL FT <sup>3</sup>
				H(LP/B)	H(W)	W	D		
L2DBH3060BF	2942	3150	3328	29	29.5	60	36	374	25
L2DBH3066BF	2988	3215	3411	29	29.5	66	36	383	26
L2DBH3072BF	3034	3282	3493	29	29.5	72	36	395	26
L2DBH3078BF	3080	3352	3575	29	29.5	78	36	422	28
L2DBH3084BF	3131	3422	3663	29	29.5	84	36	450	28
L2DBH3672BF	3191	3481	3717	29	29.5	72	42	422	28
L2DBH3678BF	3242	3558	3807	29	29.5	78	42	450	29
L2DBH3684BF	3299	3637	3907	29	29.5	84	42	477	29

**L2DR-BR • Single Pedestal Desk, Box/Box/File Right, Recessed Modesty**

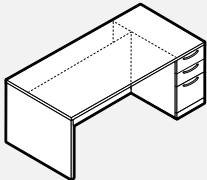

• Optional e-lock available for the pedestal in the vertical position. Please specify V - Vertical and add \$304 list.

PRODUCT CODE	FINISH LP	B	W	SIZE / INCHES				WEIGHT LBS	VOL FT <sup>3</sup>
				H(LP/B)	H(W)	W	D		
L2DR3060BR	2041	2213	2374	29	29.5	60	30	224	14
L2DR3066BR	2095	2287	2461	29	29.5	66	30	234	15
L2DR3072BR	2150	2358	2548	29	29.5	72	30	244	15
L2DR3078BR	2197	2422	2625	29	29.5	78	30	272	17
L2DR3084BR	2265	2509	2726	29	29.5	84	30	299	17
L2DR3672BR	2288	2536	2754	29	29.5	72	36	272	17
L2DR3678BR	2341	2610	2841	29	29.5	78	36	299	18
L2DR3684BR	2412	2702	2951	29	29.5	84	36	327	18

**L2DR-BL • Single Pedestal Desk, Box/Box/File Left, Recessed Modesty**

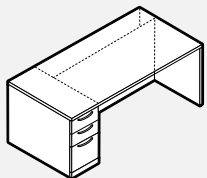

• Optional e-lock available for the pedestal in the vertical position. Please specify V - Vertical and add \$304 list.

PRODUCT CODE	FINISH LP	B	W	SIZE / INCHES				WEIGHT LBS	VOL FT <sup>3</sup>
				H(LP/B)	H(W)	W	D		
L2DR3060BL	2041	2213	2374	29	29.5	60	30	224	14
L2DR3066BL	2095	2287	2461	29	29.5	66	30	234	15
L2DR3072BL	2150	2358	2548	29	29.5	72	30	244	15
L2DR3078BL	2197	2422	2625	29	29.5	78	30	272	17
L2DR3084BL	2265	2509	2726	29	29.5	84	30	299	17
L2DR3672BL	2288	2536	2754	29	29.5	72	36	272	17
L2DR3678BL	2341	2610	2841	29	29.5	78	36	299	18
L2DR3684BL	2412	2702	2951	29	29.5	84	36	327	18

**L2DRH-BR • Single Pedestal Desk, Box/Box/File Right Recessed Half Modesty**

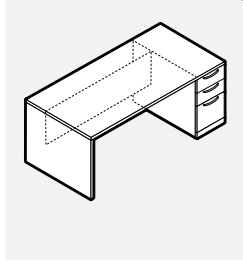

• Optional e-lock available for the pedestal in the vertical position. Please specify V - Vertical and add \$304 list.

PRODUCT CODE	FINISH LP	B	W	SIZE/INCHES			D	WEIGHT LBS	VOL FT <sup>3</sup>
				H(LP/B)	H(W)	W			
L2DRH3060BR	1909	2080	2243	29	29.5	60	30	224	14
L2DRH3066BR	1950	2141	2315	29	29.5	66	30	234	15
L2DRH3072BR	1991	2200	2391	29	29.5	72	30	244	15
L2DRH3078BR	2034	2258	2461	29	29.5	78	30	272	17
L2DRH3084BR	2079	2320	2538	29	29.5	84	30	299	17
L2DRH3672BR	2130	2379	2596	29	29.5	72	36	272	17
L2DRH3678BR	2176	2445	2678	29	29.5	78	36	299	18
L2DRH3684BR	2225	2519	2768	29	29.5	84	36	327	18

**L2DRH-BL • Single Pedestal Desk, Box/Box/File Left Recessed Half Modesty**

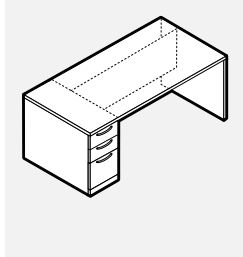

• Optional e-lock available for the pedestal in the vertical position. Please specify V - Vertical and add \$304 list.

PRODUCT CODE	FINISH LP	B	W	SIZE/INCHES			D	WEIGHT LBS	VOL FT <sup>3</sup>
				H(LP/B)	H(W)	W			
L2DRH3060BL	1909	2080	2243	29	29.5	60	30	224	14
L2DRH3066BL	1950	2141	2315	29	29.5	66	30	234	15
L2DRH3072BL	1991	2200	2391	29	29.5	72	30	244	15
L2DRH3078BL	2034	2258	2461	29	29.5	78	30	272	17
L2DRH3084BL	2079	2320	2538	29	29.5	84	30	299	17
L2DRH3672BL	2130	2379	2596	29	29.5	72	36	272	17
L2DRH3678BL	2176	2445	2678	29	29.5	78	36	299	18
L2DRH3684BL	2225	2519	2768	29	29.5	84	36	327	18

**L2DB-BR • Bowfront Single Pedestal Desk, Box/Box/File Right, Recessed Modesty**

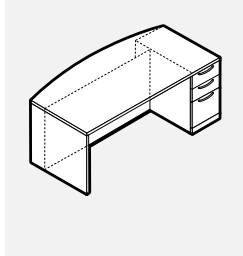

• Optional e-lock available for the pedestal in the vertical position. Please specify V - Vertical and add \$304 list.

PRODUCT CODE	FINISH LP	B	W	SIZE/INCHES			D	WEIGHT LBS	VOL FT <sup>3</sup>
				H(LP/B)	H(W)	W			
L2DB3060BR	2110	2316	2499	29	29.5	60	36	264	14
L2DB3066BR	2171	2398	2596	29	29.5	66	36	274	15
L2DB3072BR	2229	2478	2689	29	29.5	72	36	286	15
L2DB3078BR	2283	2553	2776	29	29.5	78	36	314	17
L2DB3084BR	2354	2645	2883	29	29.5	84	36	338	17
L2DB3672BR	2366	2656	2893	29	29.5	72	42	310	17
L2DB3678BR	2424	2738	2991	29	29.5	78	42	338	18
L2DB3684BR	2501	2840	3109	29	29.5	84	42	362	18

**L2DB-BL • Bowfront Single Pedestal Desk, Box/Box/File Left, Recessed Modesty**

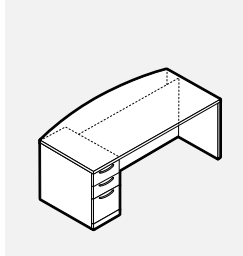

• Optional e-lock available for the pedestal in the vertical position. Please specify V - Vertical and add \$304 list.

PRODUCT CODE	FINISH LP	B	W	SIZE/INCHES			D	WEIGHT LBS	VOL FT <sup>3</sup>
				H(LP/B)	H(W)	W			
L2DB3060BL	2110	2316	2499	29	29.5	60	36	264	14
L2DB3066BL	2171	2398	2596	29	29.5	66	36	274	15
L2DB3072BL	2229	2478	2689	29	29.5	72	36	286	15
L2DB3078BL	2283	2553	2776	29	29.5	78	36	314	17
L2DB3084BL	2354	2645	2883	29	29.5	84	36	338	17
L2DB3672BL	2366	2656	2893	29	29.5	72	42	310	17
L2DB3678BL	2424	2738	2991	29	29.5	78	42	338	18
L2DB3684BL	2501	2840	3109	29	29.5	84	42	362	18

**L2DBH-BR • Bowfront Single Pedestal Desk, Box/Box/File Right Recessed Half Modesty**

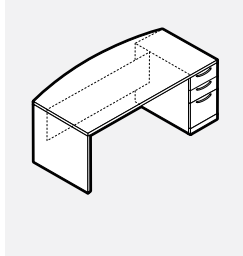

• Optional e-lock available for the pedestal in the vertical position. Please specify V - Vertical and add \$304 list.

PRODUCT CODE	FINISH LP	B	W	SIZE/INCHES			D	WEIGHT LBS	VOL FT <sup>3</sup>
				H(LP/B)	H(W)	W			
L2DBH3060BR	1977	2184	2364	29	29.5	60	36	264	14
L2DBH3066BR	2023	2252	2447	29	29.5	66	36	274	15
L2DBH3072BR	2071	2319	2530	29	29.5	72	36	286	15
L2DBH3078BR	2117	2387	2611	29	29.5	78	36	314	17
L2DBH3084BR	2168	2460	2698	29	29.5	84	36	338	17
L2DBH3672BR	2204	2499	2733	29	29.5	72	42	310	17
L2DBH3678BR	2258	2573	2827	29	29.5	78	42	338	18
L2DBH3684BR	2315	2655	2924	29	29.5	84	42	362	18

**L2DBH-BL • Bowfront Single Pedestal Desk, Box/Box/File Left Recessed Half Modesty**

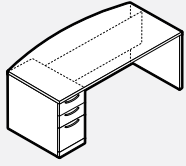

- Optional e-lock available for the pedestal in the vertical position. Please specify V - Vertical and add \$304 list.

PRODUCT CODE	FINISH LP	B	W	SIZE / INCHES				WEIGHT LBS	VOL FT <sup>3</sup>
				H (LP/B)	H (W)	W	D		
L2DBH3060BL	1977	2184	2364	29	29.5	60	36	264	14
L2DBH3066BL	2023	2252	2447	29	29.5	66	36	274	15
L2DBH3072BL	2071	2319	2530	29	29.5	72	36	286	15
L2DBH3078BL	2117	2387	2611	29	29.5	78	36	314	17
L2DBH3084BL	2168	2460	2698	29	29.5	84	36	338	17
L2DBH3672BL	2204	2499	2733	29	29.5	72	42	310	17
L2DBH3678BL	2258	2573	2827	29	29.5	78	42	338	18
L2DBH3684BL	2315	2655	2924	29	29.5	84	42	362	18

**L2DRA-FB • Double Desk, File/File Left Box/Box/File Right Recessed, Glazed Full Modesty**

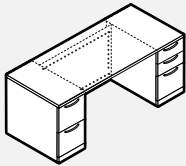

- Modesty is aluminum framed.
- Glazing is frosted acrylic.
- Optional e-lock available for each pedestal in the vertical position. Please specify V - Vertical and add \$304 list for each.

PRODUCT CODE	FINISH LP	B	W	SIZE / INCHES				WEIGHT LBS	VOL FT <sup>3</sup>
				H (LP/B)	H (W)	W	D		
L2DRA3060FB	3712	3892	4060	29.06	29.5	60	30	204	22
L2DRA3066FB	3827	4023	4208	29.06	29.5	66	30	213	23
L2DRA3072FB	3944	4157	4355	29.06	29.5	72	30	222	23
L2DRA3078FB	4054	4291	4501	29.06	29.5	78	30	247	24
L2DRA3084FB	4174	4427	4654	29.06	29.5	84	30	272	24
L2DRA3672FB	4105	4366	4589	29.06	29.5	72	36	247	24
L2DRA3678FB	4222	4505	4748	29.06	29.5	78	36	272	25
L2DRA3684FB	4348	4652	4912	29.06	29.5	84	36	297	25

**L2DRA-BF • Double Desk, File/File Right Box/Box/File Left Recessed, Glazed Full Modesty**

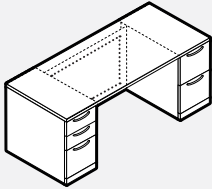

- Modesty is aluminum framed.
- Glazing is frosted acrylic.
- Optional e-lock available for each pedestal in the vertical position. Please specify V - Vertical and add \$304 list for each.

PRODUCT CODE	FINISH LP	B	W	SIZE / INCHES				WEIGHT LBS	VOL FT <sup>3</sup>
				H (LP/B)	H (W)	W	D		
L2DRA3060BF	3712	3892	4060	29.06	29.5	60	30	204	22
L2DRA3066BF	3827	4023	4208	29.06	29.5	66	30	213	23
L2DRA3072BF	3944	4157	4355	29.06	29.5	72	30	222	23
L2DRA3078BF	4054	4291	4501	29.06	29.5	78	30	247	24
L2DRA3084BF	4174	4427	4654	29.06	29.5	84	30	272	24
L2DRA3672BF	4105	4366	4589	29.06	29.5	72	36	247	24
L2DRA3678BF	4222	4505	4748	29.06	29.5	78	36	272	25
L2DRA3684BF	4348	4652	4912	29.06	29.5	84	36	297	25

**L2DBA-FB • Bowfront Double Desk, File/File Left Box/Box/File Right Recessed, Glazed Full Modesty**

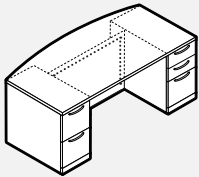

- Modesty is aluminum framed.
- Glazing is frosted acrylic.
- Optional e-lock available for each pedestal in the vertical position. Please specify V - Vertical and add \$304 list for each.

PRODUCT CODE	FINISH LP	B	W	SIZE / INCHES				WEIGHT LBS	VOL FT <sup>3</sup>
				H (LP/B)	H (W)	W	D		
L2DBA3060FB	3783	3999	4186	29.06	29.5	60	36	340	23
L2DBA3066FB	3903	4143	4343	29.06	29.5	66	36	348	24
L2DBA3072FB	4023	4284	4501	29.06	29.5	72	36	359	24
L2DBA3078FB	4144	4424	4659	29.06	29.5	78	36	384	25
L2DBA3084FB	4268	4571	4820	29.06	29.5	84	36	409	25
L2DBA3672FB	4186	4489	4733	29.06	29.5	72	42	384	25
L2DBA3678FB	4312	4640	4901	29.06	29.5	78	42	409	26
L2DBA3684FB	4442	4796	5075	29.06	29.5	84	42	434	26

**L2DBA-BF • Bowfront Double Desk, File/File Right Box/Box/File Left Recessed, Glazed Full Modesty**

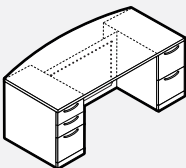

- Modesty is aluminum framed.
- Glazing is frosted acrylic.
- Optional e-lock available for each pedestal in the vertical position. Please specify V - Vertical and add \$304 list for each.

PRODUCT CODE	FINISH LP	B	W	SIZE / INCHES				WEIGHT LBS	VOL FT <sup>3</sup>
				H (LP/B)	H (W)	W	D		
L2DBA3060BF	3783	3999	4186	29.06	29.5	60	36	340	23
L2DBA3066BF	3903	4143	4343	29.06	29.5	66	36	348	24
L2DBA3072BF	4023	4284	4501	29.06	29.5	72	36	359	24
L2DBA3078BF	4144	4424	4659	29.06	29.5	78	36	384	25
L2DBA3084BF	4268	4571	4820	29.06	29.5	84	36	409	25
L2DBA3672BF	4186	4489	4733	29.06	29.5	72	42	384	25
L2DBA3678BF	4312	4640	4901	29.06	29.5	78	42	409	26
L2DBA3684BF	4442	4796	5075	29.06	29.5	84	42	434	26

**L2DRAH-FB • Double Pedestal Desk, File/File Left Box/Box/File Right Recessed, Half Glazed Modesty**

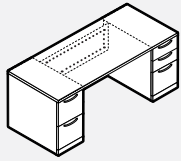

- Modesty is aluminum framed.
- Glazing is frosted acrylic.
- Optional e-lock available for each pedestal in the vertical position. Please specify V - Vertical and add \$304 list for each.

PRODUCT CODE	FINISH LP	B	W	SIZE/INCHES			D	WEIGHT LBS	VOL FT <sup>3</sup>
				H(LP/B)	H(W)	W			
L2DRAH3060FB	3514	3695	3863	29.06	29.5	60	30	204	22
L2DRAH3066FB	3609	3806	3989	29.06	29.5	66	30	213	23
L2DRAH3072FB	3691	3907	4105	29.06	29.5	72	30	222	23
L2DRAH3078FB	3776	4006	4219	29.06	29.5	78	30	247	24
L2DRAH3084FB	3863	4116	4340	29.06	29.5	84	30	272	24
L2DRAH3672FB	3854	4113	4336	29.06	29.5	72	36	247	24
L2DRAH3678FB	3944	4222	4465	29.06	29.5	78	36	272	25
L2DRAH3684FB	4036	4336	4595	29.06	29.5	84	36	297	25

**L2DRAH-BF • Double Pedestal Desk, Box/Box/File Left File/File Right Recessed, Half Glazed Modesty**

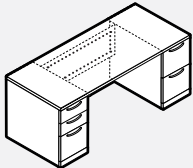

- Modesty is aluminum framed.
- Glazing is frosted acrylic.
- Optional e-lock available for each pedestal in the vertical position. Please specify V - Vertical and add \$304 list for each.

PRODUCT CODE	FINISH LP	B	W	SIZE/INCHES			D	WEIGHT LBS	VOL FT <sup>3</sup>
				H(LP/B)	H(W)	W			
L2DRAH3060BF	3514	3695	3863	29.06	29.5	60	30	204	22
L2DRAH3066BF	3609	3806	3989	29.06	29.5	66	30	213	23
L2DRAH3072BF	3691	3907	4105	29.06	29.5	72	30	222	23
L2DRAH3078BF	3776	4006	4219	29.06	29.5	78	30	247	24
L2DRAH3084BF	3863	4116	4340	29.06	29.5	84	30	272	24
L2DRAH3672BF	3854	4113	4336	29.06	29.5	72	36	247	24
L2DRAH3678BF	3944	4222	4465	29.06	29.5	78	36	272	25
L2DRAH3684BF	4036	4336	4595	29.06	29.5	84	36	297	25

**L2DBAH-FB • Bowfront Double Desk, File/File Left Box/Box/File Right Recessed, Half Glazed Modesty**

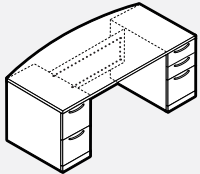

- Modesty is aluminum framed.
- Glazing is frosted acrylic.
- Optional e-lock available for each pedestal in the vertical position. Please specify V - Vertical and add \$304 list for each.

PRODUCT CODE	FINISH LP	B	W	SIZE/INCHES			D	WEIGHT LBS	VOL FT <sup>3</sup>
				H(LP/B)	H(W)	W			
L2DBAH3060FB	3584	3799	3989	29.06	29.5	60	36	340	23
L2DBAH3066FB	3683	3919	4124	29.06	29.5	66	36	348	24
L2DBAH3072FB	3773	4033	4252	29.06	29.5	72	36	359	24
L2DBAH3078FB	3860	4143	4377	29.06	29.5	78	36	384	25
L2DBAH3084FB	3955	4257	4507	29.06	29.5	84	36	409	25
L2DBAH3672FB	3936	4240	4483	29.06	29.5	72	42	384	25
L2DBAH3678FB	4032	4359	4620	29.06	29.5	78	42	409	26
L2DBAH3684FB	4127	4480	4760	29.06	29.5	84	42	434	26

**L2DBAH-BF • Bowfront Double Desk, Box/Box/File Left File/File Right Recessed, Half Glazed Modesty**

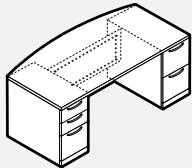

- Modesty is aluminum framed.
- Glazing is frosted acrylic.
- Optional e-lock available for each pedestal in the vertical position. Please specify V - Vertical and add \$304 list for each.

PRODUCT CODE	FINISH LP	B	W	SIZE/INCHES			D	WEIGHT LBS	VOL FT <sup>3</sup>
				H(LP/B)	H(W)	W			
L2DBAH3060BF	3584	3799	3989	29.06	29.5	60	36	340	23
L2DBAH3066BF	3683	3919	4124	29.06	29.5	66	36	348	24
L2DBAH3072BF	3773	4033	4252	29.06	29.5	72	36	359	24
L2DBAH3078BF	3860	4143	4377	29.06	29.5	78	36	384	25
L2DBAH3084BF	3955	4257	4507	29.06	29.5	84	36	409	25
L2DBAH3672BF	3936	4240	4483	29.06	29.5	72	42	384	25
L2DBAH3678BF	4032	4359	4620	29.06	29.5	78	42	409	26
L2DBAH3684BF	4127	4480	4760	29.06	29.5	84	42	434	26

**L2ER-FL • Executive Return With File/File Pedestal Left**

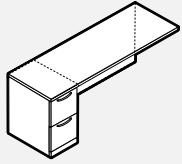

• Optional e-lock available for the pedestal in the vertical position. Please specify V-Vertical and add \$304 list.

PRODUCT CODE	FINISH			SIZE / INCHES				WEIGHT LBS	VOL FT <sup>3</sup>
	LP	B	W	H (LP/B)	H (W)	W	D		
L2ER2036FL	1458	1540	1624	29	29.5	36	20	151	12
L2ER2042FL	1509	1607	1702	29	29.5	42	20	172	12
L2ER2048FL	1563	1672	1781	29	29.5	48	20	179	12
L2ER2054FL	1614	1739	1860	29	29.5	54	20	184	13
L2ER2436FL	1515	1601	1691	29	29.5	36	24	151	12
L2ER2442FL	1569	1669	1772	29	29.5	42	24	172	12
L2ER2448FL	1624	1739	1853	29	29.5	48	24	179	13
L2ER2454FL	1679	1810	1933	29	29.5	54	24	184	13

**L2ER-FR • Executive Return With File/File Pedestal Right**

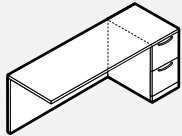

• Optional e-lock available for the pedestal in the vertical position. Please specify V-Vertical and add \$304 list.

PRODUCT CODE	FINISH			SIZE / INCHES				WEIGHT LBS	VOL FT <sup>3</sup>
	LP	B	W	H (LP/B)	H (W)	W	D		
L2ER2036FR	1458	1540	1624	29	29.5	36	20	151	12
L2ER2042FR	1509	1607	1702	29	29.5	42	20	172	12
L2ER2048FR	1563	1672	1781	29	29.5	48	20	179	12
L2ER2054FR	1614	1739	1860	29	29.5	54	20	184	13
L2ER2436FR	1515	1601	1691	29	29.5	36	24	151	12
L2ER2442FR	1569	1669	1772	29	29.5	42	24	172	12
L2ER2448FR	1624	1739	1853	29	29.5	48	24	179	13
L2ER2454FR	1679	1810	1933	29	29.5	54	24	184	13

**L2ERH-FL • Executive Return With File/File Pedestal Left and Half Modesty**

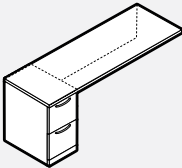

• Optional e-lock available for the pedestal in the vertical position. Please specify V-Vertical and add \$304 list.

PRODUCT CODE	FINISH			SIZE / INCHES				WEIGHT LBS	VOL FT <sup>3</sup>
	LP	B	W	H (LP/B)	H (W)	W	D		
L2ERH2036FL	1391	1475	1561	29	29.5	36	20	151	12
L2ERH2042FL	1430	1528	1624	29	29.5	42	20	172	12
L2ERH2048FL	1467	1578	1688	29	29.5	48	20	179	12
L2ERH2054FL	1505	1630	1748	29	29.5	54	20	184	13
L2ERH2436FL	1446	1533	1621	29	29.5	36	24	151	12
L2ERH2442FL	1486	1587	1679	29	29.5	42	24	172	12
L2ERH2448FL	1526	1642	1756	29	29.5	48	24	179	13
L2ERH2454FL	1565	1695	1819	29	29.5	54	24	184	13

**L2ERH-FR • Executive Return With File/File Pedestal Right and Half Modesty**

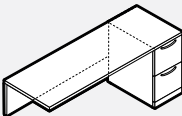

• Optional e-lock available for the pedestal in the vertical position. Please specify V-Vertical and add \$304 list.

PRODUCT CODE	FINISH			SIZE / INCHES				WEIGHT LBS	VOL FT <sup>3</sup>
	LP	B	W	H (LP/B)	H (W)	W	D		
L2ERH2036FR	1391	1475	1561	29	29.5	36	20	151	12
L2ERH2042FR	1430	1528	1624	29	29.5	42	20	172	12
L2ERH2048FR	1467	1578	1688	29	29.5	48	20	179	12
L2ERH2054FR	1505	1630	1748	29	29.5	54	20	184	13
L2ERH2436FR	1446	1533	1621	29	29.5	36	24	151	12
L2ERH2442FR	1486	1587	1679	29	29.5	42	24	172	12
L2ERH2448FR	1526	1642	1756	29	29.5	48	24	179	13
L2ERH2454FR	1565	1695	1819	29	29.5	54	24	184	13

**L2ER-BL • Executive Return With Box/Box/File Pedestal Left**

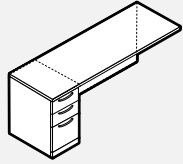

• Optional e-lock available for the pedestal in the vertical position. Please specify V - Vertical and add \$304 list.

PRODUCT CODE	FINISH LP	B	W	SIZE/INCHES				WEIGHT LBS	VOL FT <sup>3</sup>
				H(LP/B)	H(W)	W	D		
L2ER2036BL	1533	1615	1702	29	29.5	36	20	151	12
L2ER2042BL	1588	1686	1781	29	29.5	42	20	172	12
L2ER2048BL	1641	1752	1860	29	29.5	48	20	179	12
L2ER2054BL	1694	1818	1938	29	29.5	54	20	184	13
L2ER2436BL	1596	1684	1772	29	29.5	36	24	151	12
L2ER2442BL	1650	1752	1853	29	29.5	42	24	172	12
L2ER2448BL	1705	1821	1934	29	29.5	48	24	179	13
L2ER2454BL	1763	1890	2050	29	29.5	54	24	184	13

**L2ER-BR • Executive Return With Box/Box/File Pedestal Right**

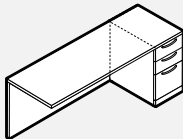

• Optional e-lock available for the pedestal in the vertical position. Please specify V - Vertical and add \$304 list.

PRODUCT CODE	FINISH LP	B	W	SIZE/INCHES				WEIGHT LBS	VOL FT <sup>3</sup>
				H(LP/B)	H(W)	W	D		
L2ER2036BR	1533	1615	1702	29	29.5	36	20	151	12
L2ER2042BR	1588	1686	1781	29	29.5	42	20	172	12
L2ER2048BR	1641	1752	1860	29	29.5	48	20	179	12
L2ER2054BR	1694	1818	1938	29	29.5	54	20	184	13
L2ER2436BR	1596	1684	1772	29	29.5	36	24	151	12
L2ER2442BR	1650	1752	1853	29	29.5	42	24	172	12
L2ER2448BR	1705	1821	1934	29	29.5	48	24	179	13
L2ER2454BR	1763	1890	2050	29	29.5	54	24	184	13

**L2ERH-BL • Executive Return With Box/Box/File Pedestal Left and Half Modesty**

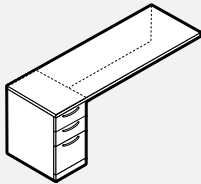

• Optional e-lock available for the pedestal in the vertical position. Please specify V - Vertical and add \$304 list.

PRODUCT CODE	FINISH LP	B	W	SIZE/INCHES				WEIGHT LBS	VOL FT <sup>3</sup>
				H(LP/B)	H(W)	W	D		
L2ERH2036BL	1470	1553	1641	29	29.5	36	20	151	12
L2ERH2042BL	1507	1542	1701	29	29.5	42	20	172	12
L2ERH2048BL	1547	1656	1766	29	29.5	48	20	179	12
L2ERH2054BL	1583	1707	1826	29	29.5	54	20	184	13
L2ERH2436BL	1528	1614	1702	29	29.5	36	24	151	12
L2ERH2442BL	1566	1668	1770	29	29.5	42	24	172	12
L2ERH2448BL	1607	1723	1836	29	29.5	48	24	179	13
L2ERH2454BL	1646	1776	1901	29	29.5	54	24	184	13

**L2ERH-BR • Executive Return With Box/Box/File Pedestal Right and Half Modesty**

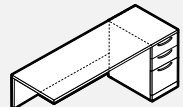

• Optional e-lock available for the pedestal in the vertical position. Please specify V - Vertical and add \$304 list.

PRODUCT CODE	FINISH LP	B	W	SIZE/INCHES				WEIGHT LBS	VOL FT <sup>3</sup>
				H(LP/B)	H(W)	W	D		
L2ERH2036BR	1470	1553	1641	29	29.5	36	20	151	12
L2ERH2042BR	1507	1542	1701	29	29.5	42	20	172	12
L2ERH2048BR	1547	1656	1766	29	29.5	48	20	179	12
L2ERH2054BR	1583	1707	1826	29	29.5	54	20	184	13
L2ERH2436BR	1528	1614	1702	29	29.5	36	24	151	12
L2ERH2442BR	1566	1668	1770	29	29.5	42	24	172	12
L2ERH2448BR	1607	1723	1836	29	29.5	48	24	179	13
L2ERH2454BR	1646	1776	1901	29	29.5	54	24	184	13

## TECHNICAL INFORMATION

### Technical Information

Reception Desk:

All desks are shipped KD.

Center desk reception transaction top is available in "LP", "B" or "W" thickness to match the thickness and profile of worksurface edge.

All other exposed edges are banded with 3mm PVC.

Center unit is freestanding and can be connected on one or both sides with a return or bridge.

**Bridge unit is connected to the center unit to extend the return on either side.**

**This unit must be connected on both ends and nonhanded.**

Left or right hand unit is designed to extend the center unit. This unit must be connected on one end.

**Can be used as a freestanding unit or connected with surrounding bridge or corner surround.**

**Comes with transaction top.**

## DESKS • GUIDELINES FOR ORDERING PRODUCT

**CODES:** The price list uses a numbering system with meaningful alphanumeric characters to create a simple-to-understand product number. This makes specifying the product much easier and more accurate.

### SPECIFICATION EXAMPLE OF A GALLERY RECEPTION DESK UNIT

#### PRODUCT CODE:

L2GR66

L2 = New Licence

G = Gallery

R = Reception

66 = Size: Width

#### OPTIONS:

Top:

LP - LP (Low Pressure Laminate) Thickness 1"

HP B - B Thickness 1 1/16"

HP W - W Thickness 1 7/16"

Top Finish Laminate:

Choose Color

Top PVC Edging:

Choose Color

Chassis Laminate:

Choose Color

Chassis PVC Edging:

Choose Color

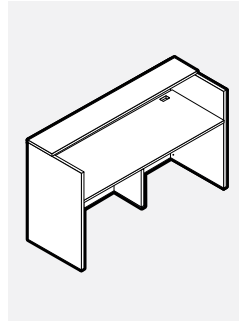



**L2GR • Gallery Reception Desk**

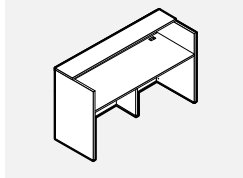

- Two grommets installed TL/TR.

PRODUCT CODE	FINISH			SIZE/INCHES				WEIGHT LBS	VOL FT <sup>3</sup>
	LP	B	W	H (LP/B)	H (W)	W	D		
L2GR66	1686	2115	2353	42.315	42.750	66	25	149	15
L2GR72	1771	2238	2494	42.315	42.750	72	25	163	17
L2GR78	1858	2358	2639	42.315	42.750	78	25	166	18
L2GR84	1943	2479	2780	42.315	42.750	84	25	171	20
L2GR96	2117	2725	3067	42.315	42.750	96	25	178	23

**L2GB • Gallery Bridge**

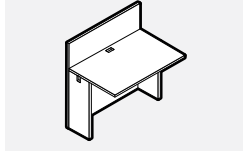

- One grommet installed TC.

PRODUCT CODE	FINISH			SIZE/INCHES				WEIGHT LBS	VOL FT <sup>3</sup>
	LP	B	W	H (LP/B)	H (W)	W	D		
L2GB42	751	946	1029	41.315	41.315	42	25	79	10
L2GB48	819	1010	1101	41.315	41.315	48	25	86	12
L2GB54	889	1101	1209	41.315	41.315	54	25	95	13
L2GB60	957	1191	1306	41.315	41.315	60	25	101	14

**L2GR-L • Gallery Left Return**

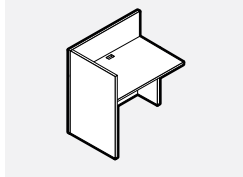

- One grommet installed TC.

PRODUCT CODE	FINISH			SIZE/INCHES				WEIGHT LBS	VOL FT <sup>3</sup>
	LP	B	W	H (LP/B)	H (W)	W	D		
L2GR36L	840	994	1064	41.315	41.315	36	25	90	9
L2GR42L	910	1084	1170	41.315	41.315	42	25	97	11
L2GR48L	977	1176	1272	41.315	41.315	48	25	106	13
L2GR54L	1046	1265	1376	41.315	41.315	54	25	119	14
L2GR60L	1115	1355	1478	41.315	41.315	60	25	132	16

**L2GR-R • Gallery Right Return**

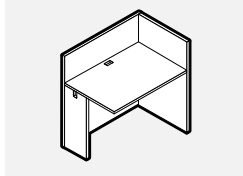

- One grommet installed TC.

PRODUCT CODE	FINISH			SIZE/INCHES				WEIGHT LBS	VOL FT <sup>3</sup>
	LP	B	W	H (LP/B)	H (W)	W	D		
L2GR36R	840	994	1064	41.315	41.315	36	25	90	9
L2GR42R	910	1084	1170	41.315	41.315	42	25	97	11
L2GR48R	977	1176	1272	41.315	41.315	48	25	106	13
L2GR54R	1046	1265	1376	41.315	41.315	54	25	119	14
L2GR60R	1115	1355	1478	41.315	41.315	60	25	132	16

**L2GD • Gallery Desk Decorative Panel**

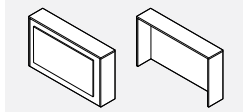

Front Back

- To be used in conjunction with a 66", 72" or 84" rectangular desk shell.
- Decorative Panel is high pressure laminate.

PRODUCT CODE	FINISH			SIZE/INCHES				WEIGHT LBS	VOL FT <sup>3</sup>
	LP	B	W	H (LP/B)	H (W)	W	D		
L2GD66	2077	2257	2450	42.315	42.750	68.25	12	99	20
L2GD72	2358	2564	2789	42.315	42.750	74.25	12	113	22
L2GD84	2531	2762	3007	42.315	42.750	86.25	12	117	25

**L2GDP • Gallery Desk With Pigeon Holes and Decorative Panel**

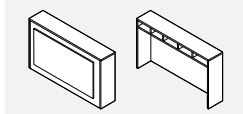

Front Back

- To be used in conjunction with a 66", 72" or 84" rectangular desk shell.
- Decorative Panel is high pressure laminate.

PRODUCT CODE	FINISH			SIZE/INCHES				WEIGHT LBS	VOL FT <sup>3</sup>
	LP	B	W	H (LP/B)	H (W)	W	D		
L2GDP66	2195	2391	2590	42.315	42.750	68.25	12	99	20
L2GDP72	2451	2721	2951	42.315	42.750	74.25	12	113	22
L2GDP84	2639	2940	3197	42.315	42.750	86.25	12	117	25

**L2GRKIT • Reception Kit Gallery**

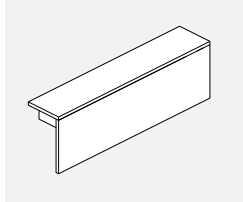

- Unit to be placed on L2DR or L2CRS Desk Shell

PRODUCT CODE	FINISH			SIZE/INCHES				WEIGHT LBS	VOL FT <sup>3</sup>
	LP	B	W	H (LP/B)	H (W)	W	D		
L2GRKIT36H36	555	588	610	18.37	18.75	36	12	68	1.50
L2GRKIT42H36	606	639	671	18.37	18.75	42	12	79	1.75
L2GRKIT48H36	659	705	733	18.37	18.75	48	12	90	2.00
L2GRKIT54H36	711	760	795	18.37	18.75	54	12	101	2.25
L2GRKIT60H36	763	820	857	18.37	18.75	60	12	113	2.50
L2GRKIT36H42	616	675	700	24.37	24.75	36	12	68	1.50
L2GRKIT42H42	678	748	772	24.37	24.75	42	12	79	1.75
L2GRKIT48H42	740	816	849	24.37	24.75	48	12	90	2.00
L2GRKIT54H42	800	894	950	24.37	24.75	54	12	101	2.25
L2GRKIT60H42	863	961	1000	24.37	24.75	60	12	113	2.50

**TECHNICAL INFORMATION**

- All Desks and connecting shells are Shipped knocked down (KD).
- All connecting units must be connected to an adjoining worksurface where there is either no end gable or a narrow gable with flat brackets.
- Gables & partial gables are interchangeable.
- All bottom edges are edge banded.
- Each shell allows for grommet (BG5) to be specified at no upcharge. Please see general information (Section A) for location.

**DESKS • GUIDELINES FOR ORDERING PRODUCT**

**CODES:** The price list uses a numbering system with meaningful alphanumeric characters to create a simple-to-understand product number. This makes specifying the product much easier and more accurate.

**SPECIFICATION EXAMPLE OF A DESK UNIT**

**PRODUCT CODE:** L2DR3060  
 L2 = New Licence  
 D = Desk  
 R = Rectangular  
 3060 = Size: Depth x Width

**OPTIONS:**  
 Top: LP - LP (Low Pressure Laminate) Thickness 1"  
 HP B - B Thickness 1 1/16"  
 HP W - W Thickness 1 7/16"

Top Finish Laminate: Choose Color  
 Top PVC Edging: Choose Color  
 Chassis Laminate: Choose Color  
 Chassis PVC Edging: Choose Color

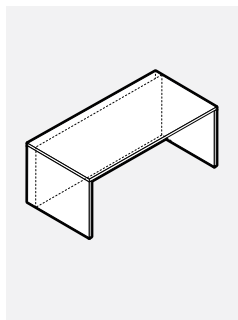

**SPECIFICATION EXAMPLE OF A CONNECTING RETURN UNIT**

**PRODUCT CODE:** L2RCH2030R  
 L2 = New Licence  
 R = Return  
 C = Connecting  
 H = Half Back Panel  
 2030 = Size: Depth x Width  
 R = Connecting on Right

**OPTIONS:**  
 Top: LP - LP (Low Pressure Laminate) Thickness 1"  
 HP B - B Thickness 1 1/16"  
 HP W - W Thickness 1 7/16"

Top Finish Laminate: Choose Color  
 Top PVC Edging: Choose Color  
 Chassis Laminate: Choose Color  
 Chassis PVC Edging: Choose Color

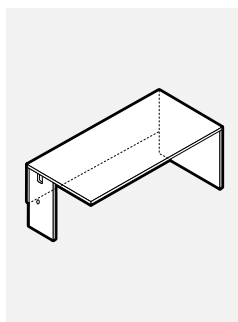

**L2DR • Rectangular Desk, Recessed Modesty**

• All recessed modesties are inset 6" from the visitor edge.

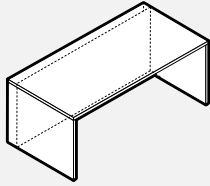

PRODUCT CODE	FINISH			SIZE/INCHES				WEIGHT LBS	VOL FT <sup>3</sup>
	LP	B	W	H(LP/B)	H(W)	W	D		
L2DR3060	1095	1338	1504	29	29.5	60	30	136	6
L2DR3066	1153	1418	1598	29	29.5	66	30	145	7
L2DR3072	1211	1495	1691	29	29.5	72	30	155	7
L2DR3078	1268	1575	1783	29	29.5	78	30	175	9
L2DR3084	1335	1661	1888	29	29.5	84	30	185	10
L2DR3660	1221	1505	1695	29	29.5	60	36	155	7
L2DR3666	1284	1594	1802	29	29.5	66	36	165	9
L2DR3672	1346	1684	1906	29	29.5	72	36	176	9
L2DR3678	1408	1771	2013	29	29.5	78	36	197	11
L2DR3684	1479	1868	2125	29	29.5	84	36	208	12

**L2DB • Bowfront Desk, Recessed Modesty**

• All recessed modesties are inset 6" from the visitor edge.

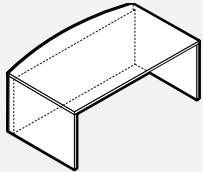

PRODUCT CODE	FINISH			SIZE/INCHES				WEIGHT LBS	VOL FT <sup>3</sup>
	LP	B	W	H(LP/B)	H(W)	W	D		
L2DB3060	1169	1450	1650	29	29.5	60	36	155	7
L2DB3066	1230	1540	1755	29	29.5	66	36	165	9
L2DB3072	1294	1629	1861	29	29.5	72	36	176	9
L2DB3078	1356	1720	1968	29	29.5	78	36	197	11
L2DB3084	1429	1815	2080	29	29.5	84	36	208	12
L2DB3660	1294	1618	1844	29	29.5	60	42	155	7
L2DB3666	1362	1720	1961	29	29.5	66	42	165	9
L2DB3672	1430	1815	2077	29	29.5	72	42	176	9
L2DB3678	1500	1915	2192	29	29.5	78	42	197	11
L2DB3684	1575	2022	2319	29	29.5	84	42	208	12

**L2CRS • Credenza Shell, Full End Gables on Both Sides and Flush Back**

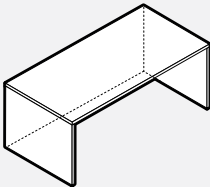

PRODUCT CODE	FINISH			SIZE/INCHES				WEIGHT LBS	VOL FT <sup>3</sup>
	LP	B	W	H(LP/B)	H(W)	W	D		
L2CRS2024	646	739	803	29	29.5	24	20	68	3
L2CRS2030	700	808	886	29	29.5	30	20	77	3
L2CRS2036	752	876	970	29	29.5	36	20	87	3
L2CRS2042	804	949	1053	29	29.5	42	20	94	3
L2CRS2048	857	1018	1135	29	29.5	48	20	102	4
L2CRS2054	908	1089	1219	29	29.5	54	20	109	4
L2CRS2060	970	1170	1310	29	29.5	60	20	118	4
L2CRS2066	1024	1236	1392	29	29.5	66	20	127	6
L2CRS2072	1076	1308	1475	29	29.5	72	20	135	6
L2CRS2078	1128	1380	1558	29	29.5	78	20	151	7
L2CRS2084	1187	1457	1650	29	29.5	84	20	160	8
L2CRS2424	671	766	837	29	29.5	24	24	68	3
L2CRS2430	728	840	922	29	29.5	30	24	77	3
L2CRS2436	783	912	1010	29	29.5	36	24	87	3
L2CRS2442	836	986	1095	29	29.5	42	24	94	3
L2CRS2448	892	1059	1181	29	29.5	48	24	102	4
L2CRS2454	945	1132	1267	29	29.5	54	24	109	4
L2CRS2460	1010	1215	1364	29	29.5	60	24	118	4
L2CRS2466	1064	1289	1448	29	29.5	66	24	127	6
L2CRS2472	1119	1358	1536	29	29.5	72	24	135	6
L2CRS2478	1173	1434	1619	29	29.5	78	24	151	7
L2CRS2484	1234	1515	1716	29	29.5	84	24	160	8
L2CRS3030	798	928	1022	29	29.5	30	30	90	3
L2CRS3036	854	1010	1118	29	29.5	36	30	99	3
L2CRS3042	912	1089	1211	29	29.5	42	30	109	4
L2CRS3048	970	1181	1305	29	29.5	48	30	119	4
L2CRS3054	1027	1248	1398	29	29.5	54	30	127	6
L2CRS3060	1095	1338	1504	29	29.5	60	30	136	6
L2CRS3066	1153	1418	1598	29	29.5	66	30	145	7
L2CRS3072	1211	1495	1691	29	29.5	72	30	155	7
L2CRS3078	1268	1575	1783	29	29.5	78	30	175	9
L2CRS3084	1335	1661	1888	29	29.5	84	30	185	10

**L2CRSH • Credenza Shell, Flush Back, Cut-Out Modesty, Full End Gables on Both Sides**

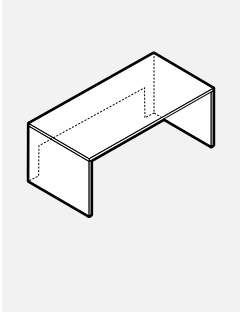

PRODUCT CODE	FINISH LP	B	W	SIZE / INCHES			WEIGHT LBS	VOL FT <sup>3</sup>	
				H (LP/B)	H (W)	D			
L2CRSH2030	626	729	811	29	29.5	30	20	77	3
L2CRSH2036	668	787	878	29	29.5	36	20	87	3
L2CRSH2042	703	841	949	29	29.5	42	20	94	3
L2CRSH2048	743	898	1015	29	29.5	48	20	102	4
L2CRSH2054	781	954	1084	29	29.5	54	20	109	4
L2CRSH2060	829	1018	1161	29	29.5	60	20	118	4
L2CRSH2066	867	1073	1229	29	29.5	66	20	127	6
L2CRSH2072	907	1130	1297	29	29.5	72	20	135	6
L2CRSH2078	944	1184	1366	29	29.5	78	20	151	7
L2CRSH2084	992	1251	1442	29	29.5	84	20	160	8
L2CRSH2430	649	773	844	29	29.5	30	24	77	3
L2CRSH2436	691	819	914	29	29.5	36	24	87	3
L2CRSH2442	733	874	984	29	29.5	42	24	94	3
L2CRSH2448	771	932	1056	29	29.5	48	24	102	4
L2CRSH2454	811	992	1128	29	29.5	54	24	109	4
L2CRSH2460	860	1059	1210	29	29.5	60	24	118	4
L2CRSH2466	902	1116	1278	29	29.5	66	24	127	6
L2CRSH2472	941	1176	1349	29	29.5	72	24	135	6
L2CRSH2478	981	1232	1423	29	29.5	78	24	151	7
L2CRSH2484	1030	1300	1501	29	29.5	84	24	160	8
L2CRSH3030	724	853	945	29	29.5	30	30	90	3
L2CRSH3036	766	918	1026	29	29.5	36	30	99	3
L2CRSH3042	813	982	1105	29	29.5	42	30	109	4
L2CRSH3048	857	1048	1184	29	29.5	48	30	119	4
L2CRSH3054	900	1113	1264	29	29.5	54	30	127	6
L2CRSH3060	944	1177	1345	29	29.5	60	30	139	6
L2CRSH3066	986	1245	1425	29	29.5	66	30	145	7
L2CRSH3072	1031	1308	1504	29	29.5	72	30	155	7
L2CRSH3078	1076	1376	1583	29	29.5	78	30	175	9
L2CRSH3084	1119	1437	1661	29	29.5	84	30	185	10

**L2RC-R • Return, Connecting Right, Full Gable on Right and Narrow Gable on Left**

Units are non-handed. They can be configured as either lefts or rights.

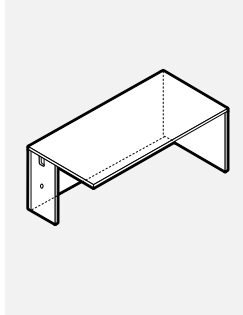

PRODUCT CODE	FINISH			SIZE/INCHES				WEIGHT LBS	VOL FT <sup>3</sup>
	LP	B	W	H(LP/B)	H(W)	W	D		
L2RC2024R	606	697	762	29	29.5	24	20	64	3
L2RC2030R	663	768	851	29	29.5	30	20	69	3
L2RC2036R	719	843	938	29	29.5	36	20	79	3
L2RC2042R	776	918	1021	29	29.5	42	20	86	3
L2RC2048R	832	992	1110	29	29.5	48	20	95	4
L2RC2054R	886	1065	1194	29	29.5	54	20	102	4
L2RC2060R	957	1155	1297	29	29.5	60	20	110	4
L2RC2066R	1015	1229	1385	29	29.5	66	20	119	6
L2RC2072R	1076	1308	1475	29	29.5	72	20	128	6
L2RC2078R	1132	1383	1563	29	29.5	78	20	143	7
L2RC2084R	1187	1454	1650	29	29.5	84	20	152	8
L2RC2424R	631	724	794	29	29.5	24	24	64	3
L2RC2430R	691	799	883	29	29.5	30	24	69	3
L2RC2436R	749	876	973	29	29.5	36	24	79	3
L2RC2442R	806	954	1063	29	29.5	42	24	86	3
L2RC2448R	865	1030	1155	29	29.5	48	24	95	4
L2RC2454R	922	1110	1245	29	29.5	54	24	102	4
L2RC2460R	998	1203	1349	29	29.5	60	24	110	4
L2RC2466R	1056	1278	1441	29	29.5	66	24	119	6
L2RC2472R	1119	1358	1536	29	29.5	72	24	128	6
L2RC2478R	1176	1436	1624	29	29.5	78	24	143	7
L2RC2484R	1234	1515	1715	29	29.5	84	24	152	8
L2RC3030R	752	881	976	29	29.5	30	30	83	3
L2RC3036R	813	965	1073	29	29.5	36	30	91	3
L2RC3042R	874	1049	1172	29	29.5	42	30	101	4
L2RC3048R	937	1132	1268	29	29.5	48	30	111	4
L2RC3054R	998	1215	1366	29	29.5	54	30	119	6
L2RC3060R	1073	1313	1483	29	29.5	60	30	129	6
L2RC3066R	1135	1396	1578	29	29.5	66	30	138	7
L2RC3072R	1203	1486	1683	29	29.5	72	30	147	7
L2RC3078R	1267	1569	1880	29	29.5	78	30	167	9
L2RC3084R	1326	1652	1984	29	29.5	84	30	177	10
L2RC3660R	1161	1445	1634	29	29.5	60	36	145	7
L2RC3666R	1229	1537	1743	29	29.5	66	36	157	9
L2RC3672R	1300	1636	1857	29	29.5	72	36	169	9
L2RC3678R	1367	1727	1968	29	29.5	78	36	190	11
L2RC3684R	1432	1819	2077	29	29.5	84	36	201	12

**L2RCH-R • Half Modesty Return, Connecting Right, Full Gable on Right and Narrow Gable on Left**

• Units are non-handed. They can be configured as either lefts or rights.

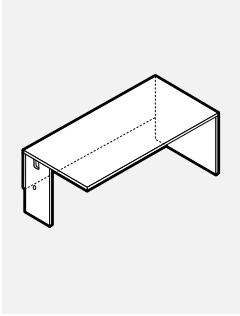

PRODUCT CODE	FINISH LP	B	W	SIZE / INCHES			WEIGHT LBS	VOL FT <sup>3</sup>	
				H (LP/B)	H (W)	D			
L2RCH2024R	539	643	713	29	29.5	24	20	55	3
L2RCH2030R	579	703	784	29	29.5	30	20	57	3
L2RCH2036R	621	763	857	29	29.5	36	20	65	3
L2RCH2042R	659	819	929	29	29.5	42	20	69	3
L2RCH2048R	700	880	999	29	29.5	48	20	76	4
L2RCH2054R	741	938	1070	29	29.5	54	20	81	4
L2RCH2060R	794	1014	1162	29	29.5	60	20	86	4
L2RCH2066R	836	1070	1230	29	29.5	66	20	92	6
L2RCH2072R	878	1138	1308	29	29.5	72	20	99	6
L2RCH2078R	918	1196	1342	29	29.5	78	20	112	7
L2RCH2084R	960	1254	1454	29	29.5	84	20	119	8
L2RCH2424R	558	843	741	29	29.5	24	24	56	3
L2RCH2430R	600	729	815	29	29.5	30	24	57	3
L2RCH2436R	644	792	891	29	29.5	36	24	65	3
L2RCH2442R	686	853	966	29	29.5	42	24	69	3
L2RCH2448R	728	913	1041	29	29.5	48	24	76	4
L2RCH2454R	768	976	1113	29	29.5	54	24	81	4
L2RCH2460R	829	1054	1208	29	29.5	60	24	86	4
L2RCH2466R	869	1113	1280	29	29.5	66	24	92	6
L2RCH2472R	914	1180	1360	29	29.5	72	24	99	6
L2RCH2478R	956	1245	1436	29	29.5	78	24	112	7
L2RCH2484R	998	1305	1511	29	29.5	84	24	119	8
L2RCH3030R	668	817	913	29	29.5	30	30	77	3
L2RCH3036R	712	886	998	29	29.5	36	30	83	3
L2RCH3042R	757	954	1081	29	29.5	42	30	87	4
L2RCH3048R	804	1024	1166	29	29.5	48	30	92	4
L2RCH3054R	851	1091	1251	29	29.5	54	30	98	6
L2RCH3060R	911	1176	1349	29	29.5	60	30	105	6
L2RCH3066R	956	1248	1432	29	29.5	66	30	111	7
L2RCH3072R	1005	1317	1520	29	29.5	72	30	119	7
L2RCH3078R	1052	1387	1694	29	29.5	78	30	136	9
L2RCH3084R	1097	1454	1780	29	29.5	84	30	144	10
L2RCH3660R	998	1310	1456	29	29.5	60	36	123	7
L2RCH3666R	1049	1389	1601	29	29.5	66	36	129	9
L2RCH3672R	1102	1473	1701	29	29.5	72	36	141	9
L2RCH3678R	1155	1550	1797	29	29.5	78	36	154	11
L2RCH3684R	1207	1561	1891	29	29.5	84	36	162	12

**L2RC-L • Return, Connecting Left, Full Gable on Left and Narrow Gable on Right**

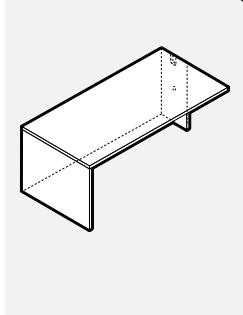

• Units are non-handed. They can be configured as either lefts or rights.

PRODUCT CODE	FINISH			SIZE / INCHES				WEIGHT LBS	VOL FT <sup>3</sup>
	LP	B	W	H (LP/B)	H (W)	W	D		
L2RC2024L	606	697	762	29	29.5	24	20	64	3
L2RC2030L	663	768	851	29	29.5	30	20	69	3
L2RC2036L	719	843	938	29	29.5	36	20	79	3
L2RC2042L	776	918	1021	29	29.5	42	20	86	3
L2RC2048L	832	992	1110	29	29.5	48	20	95	4
L2RC2054L	886	1065	1194	29	29.5	54	20	102	4
L2RC2060L	957	1155	1297	29	29.5	60	20	110	4
L2RC2066L	1015	1229	1385	29	29.5	66	20	119	6
L2RC2072L	1076	1308	1475	29	29.5	72	20	128	6
L2RC2078L	1132	1383	1563	29	29.5	78	20	143	7
L2RC2084L	1187	1454	1650	29	29.5	84	20	152	8
L2RC2424L	631	724	794	29	29.5	24	24	64	3
L2RC2430L	691	799	883	29	29.5	30	24	69	3
L2RC2436L	749	876	973	29	29.5	36	24	79	3
L2RC2442L	806	954	1063	29	29.5	42	24	86	3
L2RC2448L	865	1030	1155	29	29.5	48	24	95	4
L2RC2454L	922	1110	1245	29	29.5	54	24	102	4
L2RC2460L	998	1203	1385	29	29.5	60	24	110	4
L2RC2466L	1056	1278	1441	29	29.5	66	24	119	6
L2RC2472L	1119	1358	1536	29	29.5	72	24	128	6
L2RC2478L	1177	1436	1624	29	29.5	78	24	143	7
L2RC2484L	1234	1515	1715	29	29.5	84	24	152	8
L2RC3030L	752	881	976	29	29.5	30	30	83	3
L2RC3036L	813	965	1073	29	29.5	36	30	91	3
L2RC3042L	874	1049	1172	29	29.5	42	30	101	4
L2RC3048L	937	1132	1268	29	29.5	48	30	111	4
L2RC3054L	998	1215	1366	29	29.5	54	30	119	6
L2RC3060L	1073	1313	1483	29	29.5	60	30	129	6
L2RC3066L	1135	1396	1578	29	29.5	66	30	138	7
L2RC3072L	1203	1486	1683	29	29.5	72	30	147	7
L2RC3078L	1263	1569	1880	29	29.5	78	30	167	9
L2RC3084L	1326	1652	1984	29	29.5	84	30	177	10
L2RC3660L	1161	1445	1634	29	29.5	60	36	145	7
L2RC3666L	1229	1537	1743	29	29.5	66	36	157	9
L2RC3672L	1300	1636	1857	29	29.5	72	36	169	9
L2RC3678L	1367	1727	1968	29	29.5	78	36	190	11
L2RC3684L	1432	1819	2077	29	29.5	84	36	201	12

**L2RCH-L • Half Modesty Return, Connecting Left, Full Gable on Left and Narrow Gable on Right**

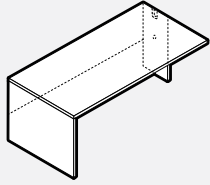

• Units are non-handed. They can be configured as either lefts or rights.

PRODUCT CODE	FINISH			SIZE / INCHES				WEIGHT		VOL FT <sup>3</sup>
	LP	B	W	H (LP/B)	H (W)	W	D	LBS		
L2RCH2024L	539	643	713	29	29.5	24	20	55	3	
L2RCH2030L	579	703	784	29	29.5	30	20	57	3	
L2RCH2036L	621	763	857	29	29.5	36	20	65	3	
L2RCH2042L	659	819	929	29	29.5	42	20	69	3	
L2RCH2048L	700	880	999	29	29.5	48	20	76	4	
L2RCH2054L	741	938	1070	29	29.5	54	20	81	4	
L2RCH2060L	794	1014	1162	29	29.5	60	20	86	4	
L2RCH2066L	836	1070	1230	29	29.5	66	20	92	5	
L2RCH2072L	878	1138	1308	29	29.5	72	20	99	5	
L2RCH2078L	918	1196	1342	29	29.5	78	20	112	6	
L2RCH2084L	960	1254	1454	29	29.5	84	20	119	7	
L2RCH2424L	558	843	741	29	29.5	24	24	56	3	
L2RCH2430L	600	729	815	29	29.5	30	24	57	3	
L2RCH2436L	644	792	891	29	29.5	36	24	65	3	
L2RCH2442L	686	853	966	29	29.5	42	24	69	3	
L2RCH2448L	728	913	1041	29	29.5	48	24	76	4	
L2RCH2454L	768	976	1113	29	29.5	54	24	81	4	
L2RCH2460L	829	1054	1208	29	29.5	60	24	86	4	
L2RCH2466L	869	1113	1280	29	29.5	66	24	92	5	
L2RCH2472L	914	1180	1360	29	29.5	72	24	99	5	
L2RCH2478L	956	1245	1436	29	29.5	78	24	112	6	
L2RCH2484L	998	1305	1511	29	29.5	84	24	119	7	
L2RCH3030L	668	817	913	29	29.5	30	30	77	3	
L2RCH3036L	712	886	998	29	29.5	36	30	83	3	
L2RCH3042L	757	954	1081	29	29.5	42	30	87	4	
L2RCH3048L	804	1024	1166	29	29.5	48	30	92	4	
L2RCH3054L	851	1091	1251	29	29.5	54	30	98	5	
L2RCH3060L	911	1176	1349	29	29.5	60	30	105	5	
L2RCH3066L	956	1248	1432	29	29.5	66	30	111	6	
L2RCH3072L	1005	1317	1520	29	29.5	72	30	119	6	
L2RCH3078L	1052	1387	1694	29	29.5	78	30	136	8	
L2RCH3084L	1097	1454	1780	29	29.5	84	30	144	9	
L2RCH3660L	998	1310	1456	29	29.5	60	36	123	6	
L2RCH3666L	1049	1389	1601	29	29.5	66	36	129	8	
L2RCH3672L	1102	1473	1701	29	29.5	72	36	141	8	
L2RCH3678L	1155	1550	1797	29	29.5	78	36	154	10	
L2RCH3684L	1207	1561	1891	29	29.5	84	36	162	11	



**L2RC-C • Return, Connecting Narrow Gables on Both Sides**

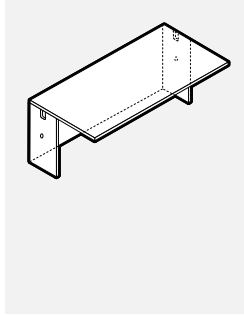

PRODUCT CODE	FINISH			SIZE / INCHES				WEIGHT LBS	VOL FT <sup>3</sup>
	LP	B	W	H (LP/B)	H (W)	W	D		
L2RC2024C	539	626	692	29	29.5	24	20	56	3
L2RC2030C	595	671	749	29	29.5	30	20	62	3
L2RC2036C	649	741	832	29	29.5	36	20	72	3
L2RC2042C	707	811	912	29	29.5	42	20	78	3
L2RC2048C	762	881	995	29	29.5	48	20	87	4
L2RC2054C	819	950	1076	29	29.5	54	20	95	4
L2RC2060C	892	1036	1173	29	29.5	60	20	102	4
L2RC2066C	949	1105	1257	29	29.5	66	20	111	6
L2RC2072C	1008	1180	1343	29	29.5	72	20	120	6
L2RC2078C	1064	1251	1425	29	29.5	78	20	135	7
L2RC2084C	1119	1319	1507	29	29.5	84	20	144	8
L2RC2424C	562	649	719	29	29.5	24	24	56	3
L2RC2430C	621	698	781	29	29.5	30	24	62	3
L2RC2436C	679	771	865	29	29.5	36	24	72	3
L2RC2442C	736	843	950	29	29.5	42	24	78	3
L2RC2448C	794	916	1035	29	29.5	48	24	87	4
L2RC2454C	853	989	1119	29	29.5	54	24	95	4
L2RC2460C	925	1078	1221	29	29.5	60	24	102	4
L2RC2466C	984	1151	1305	29	29.5	66	24	111	6
L2RC2472C	1049	1226	1396	29	29.5	72	24	120	6
L2RC2478C	1107	1300	1483	29	29.5	78	24	135	7
L2RC2484C	1166	1373	1566	29	29.5	84	24	144	8
L2RC3030C	696	820	914	29	29.5	30	30	75	3
L2RC3036C	754	903	1011	29	29.5	36	30	84	3
L2RC3042C	815	986	1111	29	29.5	42	30	94	4
L2RC3048C	876	1021	1155	29	29.5	48	30	103	4
L2RC3054C	940	1101	1247	29	29.5	54	30	116	6
L2RC3060C	1015	1196	1354	29	29.5	60	30	121	6
L2RC3066C	1078	1272	1446	29	29.5	66	30	130	7
L2RC3072C	1143	1356	1545	29	29.5	72	30	140	7
L2RC3078C	1207	1436	1637	29	29.5	78	30	160	9
L2RC3084C	1267	1512	1731	29	29.5	84	30	169	10

**L2RCH-C • Half Modesty Return, Connecting Narrow Gables on Both Sides**

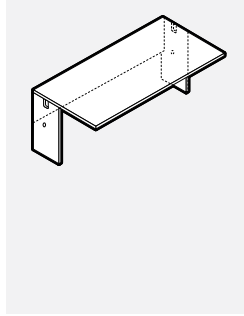

PRODUCT CODE	FINISH LP	B	W	SIZE/INCHES			D	WEIGHT LBS	VOL FT <sup>3</sup>
				H (LP/B)	H (W)	W			
L2RCH2024C	471	554	622	29	29.5	24	20	46	3
L2RCH2030C	513	612	691	29	29.5	30	20	50	3
L2RCH2036C	551	670	739	29	29.5	36	20	57	3
L2RCH2042C	592	725	832	29	29.5	42	20	62	3
L2RCH2048C	633	784	900	29	29.5	48	20	68	4
L2RCH2054C	649	840	970	29	29.5	54	20	74	4
L2RCH2060C	707	914	1057	29	29.5	60	20	78	4
L2RCH2066C	749	970	1127	29	29.5	66	20	85	6
L2RCH2072C	792	1031	1199	29	29.5	72	20	91	6
L2RCH2078C	832	1090	1270	29	29.5	78	20	105	7
L2RCH2084C	873	1145	1342	29	29.5	84	20	111	8
L2RCH2424C	491	577	646	29	29.5	24	24	46	3
L2RCH2430C	534	637	719	29	29.5	30	24	50	3
L2RCH2436C	576	696	792	29	29.5	36	24	57	3
L2RCH2442C	617	754	865	29	29.5	42	24	62	3
L2RCH2448C	658	815	938	29	29.5	48	24	68	4
L2RCH2454C	679	874	1010	29	29.5	54	24	74	4
L2RCH2460C	736	950	1099	29	29.5	60	24	78	4
L2RCH2466C	778	1010	1172	29	29.5	66	24	85	6
L2RCH2472C	824	1073	1248	29	29.5	72	24	91	6
L2RCH2478C	865	1134	1319	29	29.5	78	24	105	7
L2RCH2484C	907	1191	1392	29	29.5	84	24	111	8
L2RCH3030C	608	734	829	29	29.5	30	30	72	3
L2RCH3036C	655	775	907	29	29.5	36	30	80	3
L2RCH3042C	700	865	986	29	29.5	42	30	85	4
L2RCH3048C	746	932	1069	29	29.5	48	30	90	4
L2RCH3054C	792	999	1151	29	29.5	54	30	95	6
L2RCH3060C	853	1081	1248	29	29.5	60	30	97	6
L2RCH3066C	898	1148	1332	29	29.5	66	30	103	7
L2RCH3072C	949	1221	1418	29	29.5	72	30	111	7
L2RCH3078C	994	1289	1452	29	29.5	78	30	129	9
L2RCH3084C	1038	1353	1577	29	29.5	84	30	136	10

**L2RCS • Return Connecting Swerve Left**

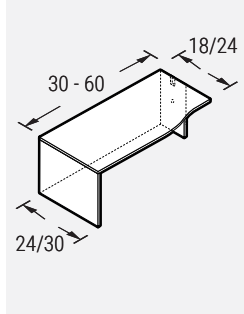

PRODUCT CODE	FINISH LP	B	W	SIZE/INCHES			D	WEIGHT LBS	VOL FT <sup>3</sup>
				H (LP/B)	H (W)	W			
L2RCS243018	729	840	977	29	29.5	30	24	70	2
L2RCS243618	787	914	1064	29	29.5	36	24	79	3
L2RCS244218	841	989	1151	29	29.5	42	24	88	3
L2RCS244818	898	1060	1234	29	29.5	48	24	97	4
L2RCS245418	954	1135	1321	29	29.5	54	24	106	4
L2RCS246018	1026	1225	1426	29	29.5	60	24	114	4
L2RCS303024	795	928	1135	29	29.5	30	30	81	3
L2RCS303624	857	1011	1176	29	29.5	36	30	91	3
L2RCS304224	918	1095	1273	29	29.5	42	30	109	4
L2RCS304824	979	1177	1372	29	29.5	48	30	119	4
L2RCS305424	1040	1262	1469	29	29.5	54	30	127	6
L2RCS306024	1102	1344	1566	29	29.5	60	30	136	6

**L2RCS • Return Connecting Swerve Right**

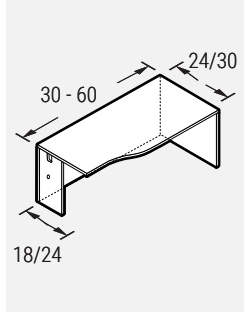

PRODUCT CODE	FINISH LP	B	W	SIZE/INCHES			D	WEIGHT LBS	VOL FT <sup>3</sup>
				H (LP/B)	H (W)	W			
L2RCS183024	729	840	977	29	29.9	30	24	70	2
L2RCS183624	787	914	1063	29	29.5	36	24	79	3
L2RCS184224	841	989	1151	29	29.5	42	24	88	3
L2RCS184824	898	1062	1234	29	29.5	48	24	97	4
L2RCS185424	954	1135	1321	29	29.5	54	24	106	4
L2RCS186024	1026	1225	1426	29	29.5	60	24	114	4
L2RCS243030	795	928	1078	29	29.5	30	30	81	3
L2RCS243630	857	1011	1176	29	29.5	36	30	91	3
L2RCS244230	918	1095	1273	29	29.5	42	30	109	4
L2RCS244830	979	1177	1372	29	29.5	48	30	119	4
L2RCS245430	1040	1262	1469	29	29.5	54	30	127	6
L2RCS246030	1102	1344	1566	29	29.5	60	30	136	6

**L2RCSH • Return Connecting Swerve Left With Half Modesty Panel**

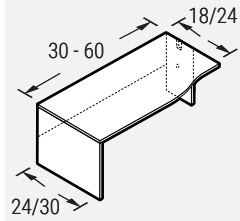

PRODUCT CODE	FINISH LP	B	W	SIZE/INCHES				WEIGHT LBS	VOL FT <sup>3</sup>
				H(LP/B)	H(W)	W	D		
L2RCSH243018	646	752	891	29	29.5	30	24	61	2
L2RCSH243618	686	808	957	29	29.5	36	24	65	3
L2RCSH244218	725	867	1027	29	29.5	42	24	72	3
L2RCSH244818	766	923	1099	29	29.5	48	24	77	4
L2RCSH245418	806	981	1169	29	29.5	54	24	84	4
L2RCSH246018	862	1056	1256	29	29.5	60	24	90	4
L2RCSH303024	711	840	992	29	29.5	30	30	78	3
L2RCSH303624	756	907	1072	29	29.5	36	30	88	3
L2RCSH304224	802	1004	1153	29	29.5	42	30	105	4
L2RCSH304824	848	1040	1232	29	29.5	48	30	114	4
L2RCSH305424	895	1107	1313	29	29.5	54	30	121	5
L2RCSH306024	940	1184	1394	29	29.5	60	30	130	5

**L2RCSH • Return Connecting Swerve Right With Half Modesty Panel**

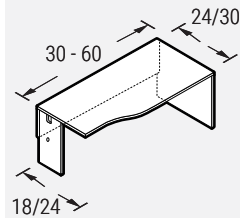

PRODUCT CODE	FINISH LP	B	W	SIZE/INCHES				WEIGHT LBS	VOL FT <sup>3</sup>
				H(LP/B)	H(W)	W	D		
L2RCSH183024	646	752	891	29	29.5	30	24	61	2
L2RCSH183624	686	808	957	29	29.5	36	24	65	3
L2RCSH184224	725	867	1027	29	29.5	42	24	72	3
L2RCSH184824	766	923	1099	29	29.5	48	24	77	4
L2RCSH185424	806	981	1169	29	29.5	54	24	84	4
L2RCSH186024	862	1056	1256	29	29.5	60	24	90	4
L2RCSH243030	711	840	992	29	29.5	30	30	78	3
L2RCSH243630	756	907	1072	29	29.5	36	30	88	3
L2RCSH244230	802	1004	1153	29	29.5	42	30	105	4
L2RCSH244830	848	1040	1232	29	29.5	48	30	114	4
L2RCSH245430	895	1107	1313	29	29.5	54	30	121	6
L2RCSH246030	940	1184	1394	29	29.5	60	30	130	6

**L2RCW • Return Connecting Wedge Left**

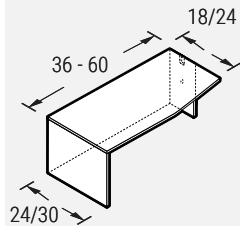

PRODUCT CODE	FINISH LP	B	W	SIZE/INCHES				WEIGHT LBS	VOL FT <sup>3</sup>
				H(LP/B)	H(W)	W	D		
L2RCW243018	729	840	977	29	29.5	30	24	70	2
L2RCW243618	787	914	1063	29	29.5	36	24	79	3
L2RCW244218	841	989	1151	29	29.5	42	24	88	3
L2RCW244818	898	1060	1234	29	29.5	48	24	97	4
L2RCW245418	954	1135	1321	29	29.5	54	24	106	4
L2RCW246018	1026	1225	1426	29	29.5	60	24	114	4
L2RCW303024	795	928	1078	29	29.5	30	30	81	3
L2RCW303624	857	1011	1176	29	29.5	36	30	91	3
L2RCW304224	918	1095	1272	29	29.5	42	30	109	4
L2RCW304824	981	1177	1373	29	29.5	48	30	119	4
L2RCW305424	1040	1261	1470	29	29.5	54	30	127	6
L2RCW306024	1102	1345	1566	29	29.5	60	30	136	6

**L2RCW • Return Connecting Wedge Right**

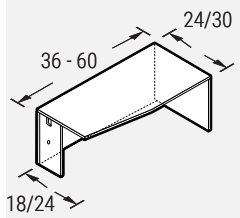

PRODUCT CODE	FINISH LP	B	W	SIZE/INCHES				WEIGHT LBS	VOL FT <sup>3</sup>
				H(LP/B)	H(W)	W	D		
L2RCW183024	729	840	976	29	29.5	30	24	70	2
L2RCW183624	787	914	1063	29	29.5	36	24	79	3
L2RCW184224	841	989	1150	29	29.5	42	24	88	3
L2RCW184824	898	1060	1234	29	29.5	48	24	97	4
L2RCW185424	954	1135	1321	29	29.5	54	24	106	4
L2RCW186024	1026	1225	1426	29	29.5	60	24	114	4
L2RCW243030	795	928	1078	29	29.5	30	30	81	3
L2RCW243630	857	1011	1176	29	29.5	36	30	91	3
L2RCW244230	918	1095	1272	29	29.5	42	30	109	4
L2RCW244830	981	1177	1373	29	29.5	48	30	119	4
L2RCW245430	1040	1261	1470	29	29.5	54	30	127	6
L2RCW246030	1102	1345	1566	29	29.5	60	30	136	6

**L2RCWH • Return Connecting Wedge Left With Half Modesty**

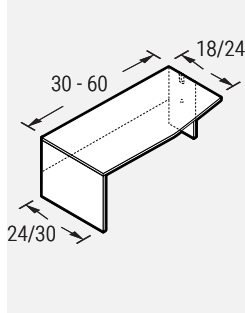

PRODUCT CODE	FINISH			SIZE/INCHES				WEIGHT		VOL FT <sup>3</sup>
	LP	B	W	H (LP/B)	H (W)	W	D	LBS		
L2RCWH243018	646	752	891	29	29.5	30	24	61	2	
L2RCWH243618	686	808	957	29	29.5	36	24	65	3	
L2RCWH244218	725	867	1027	29	29.5	42	24	72	3	
L2RCWH244818	766	923	1099	29	29.5	48	24	77	4	
L2RCWH245418	806	981	1169	29	29.5	54	24	84	4	
L2RCWH246018	862	1056	1256	29	29.5	60	24	90	4	
L2RCWH303024	711	840	992	29	29.5	30	30	78	3	
L2RCWH303624	756	907	1072	29	29.5	36	30	88	3	
L2RCWH304224	802	972	1153	29	29.5	42	30	105	4	
L2RCWH304824	848	1040	1232	29	29.5	48	30	114	4	
L2RCWH305424	895	1107	1313	29	29.5	54	30	121	6	
L2RCWH306024	940	1173	1394	29	29.5	60	30	130	6	

**L2RCWH • Return Connecting Wedge Right With Half Modesty**

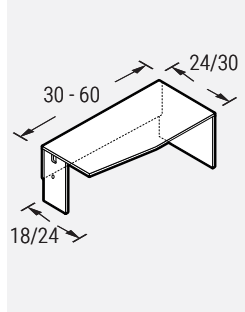

PRODUCT CODE	FINISH			SIZE/INCHES				WEIGHT		VOL FT <sup>3</sup>
	LP	B	W	H (LP/B)	H (W)	W	D	LBS		
L2RCWH183024	646	752	891	29	29.5	30	24	61	2	
L2RCWH183624	686	808	957	29	29.5	36	24	65	3	
L2RCWH184224	725	867	1027	29	29.5	42	24	72	3	
L2RCWH184824	766	923	1099	29	29.5	48	24	77	4	
L2RCWH185424	806	981	1169	29	29.5	54	24	84	4	
L2RCWH186024	862	1056	1256	29	29.5	60	24	90	4	
L2RCWH243030	711	840	992	29	29.5	30	30	78	3	
L2RCWH243630	756	907	1072	29	29.5	36	30	88	3	
L2RCWH244230	802	972	1153	29	29.5	42	30	105	4	
L2RCWH244830	848	1040	1232	29	29.5	48	30	114	4	
L2RCWH245430	895	1107	1313	29	29.5	54	30	121	6	
L2RCWH246030	940	1173	1394	29	29.5	60	30	130	6	

**L2ER-L • Executive Return Left**

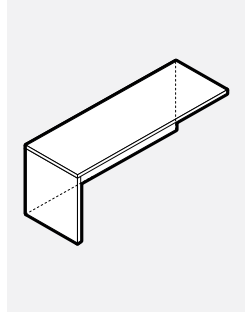

• Units are non-handed. They can be configured as either lefts or rights.

PRODUCT CODE	FINISH			SIZE/INCHES				WEIGHT		VOL FT <sup>3</sup>
	LP	B	W	H (LP/B)	H (W)	W	D	LBS		
L2ER2024L	484	567	633	29	29.5	24	20	25	3	
L2ER2030L	541	642	719	29	29.5	30	20	29	3	
L2ER2036L	600	722	816	29	29.5	36	20	32	3	
L2ER2042L	665	804	911	29	29.5	42	20	35	3	
L2ER2048L	722	876	998	29	29.5	48	20	37	4	
L2ER2054L	778	952	1084	29	29.5	54	20	40	4	
L2ER2060L	851	1040	1187	29	29.5	60	20	44	4	
L2ER2066L	907	1115	1272	29	29.5	66	20	46	6	
L2ER2072L	961	1188	1364	29	29.5	72	20	50	6	
L2ER2424L	504	592	658	29	29.5	24	24	25	3	
L2ER2430L	562	668	746	29	29.5	30	24	29	3	
L2ER2436L	626	750	851	29	29.5	36	24	32	3	
L2ER2442L	692	836	949	29	29.5	42	24	35	3	
L2ER2448L	750	912	1036	29	29.5	48	24	37	4	
L2ER2454L	808	989	1128	29	29.5	54	24	40	4	
L2ER2460L	883	1081	1232	29	29.5	60	24	44	4	
L2ER2466L	941	1161	1326	29	29.5	66	24	46	6	
L2ER2472L	999	1237	1421	29	29.5	72	24	50	6	

**L2ERH-L • Executive Return Left, Half Modesty**

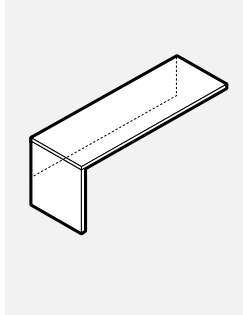

• Units are non-handed. They can be configured as either lefts or rights.

PRODUCT CODE	FINISH			SIZE/INCHES				WEIGHT LBS	VOL FT <sup>3</sup>
	LP	B	W	H (LP/B)	H (W)	W	D		
L2ERH2024L	419	497	562	29	29.5	24	20	25	3
L2ERH2030L	458	554	631	29	29.5	30	20	29	3
L2ERH2036L	601	625	719	29	29.5	36	20	32	3
L2ERH2042L	665	682	790	29	29.5	42	20	35	3
L2ERH2048L	722	741	860	29	29.5	48	20	37	4
L2ERH2054L	778	795	928	29	29.5	54	20	40	4
L2ERH2060L	851	870	1015	29	29.5	60	20	44	4
L2ERH2066L	905	925	1084	29	29.5	66	20	46	6
L2ERH2072L	961	984	1160	29	29.5	72	20	50	6
L2ERH2424L	433	517	584	29	29.5	24	24	25	3
L2ERH2430L	475	577	655	29	29.5	30	24	29	3
L2ERH2436L	530	648	749	29	29.5	36	24	32	3
L2ERH2442L	572	708	820	29	29.5	42	24	35	3
L2ERH2448L	615	768	895	29	29.5	48	24	37	4
L2ERH2454L	655	830	965	29	29.5	54	24	40	4
L2ERH2460L	712	903	1056	29	29.5	60	24	44	4
L2ERH2466L	754	964	1128	29	29.5	66	24	46	6
L2ERH2472L	795	1024	1208	29	29.5	72	24	50	6

**L2ER-R • Executive Return Right**

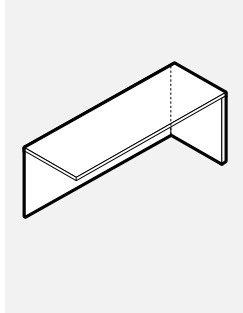

• Units are non-handed. They can be configured as either lefts or rights.

PRODUCT CODE	FINISH			SIZE/INCHES				WEIGHT LBS	VOL FT <sup>3</sup>
	LP	B	W	H (LP/B)	H (W)	W	D		
L2ER2024R	484	567	633	29	29.5	24	20	55	3
L2ER2030R	541	642	719	29	29.5	30	20	63	3
L2ER2036R	600	722	816	29	29.5	36	20	70	3
L2ER2042R	665	804	911	29	29.5	42	20	77	3
L2ER2048R	722	876	998	29	29.5	48	20	87	4
L2ER2054R	778	952	1084	29	29.5	54	20	92	4
L2ER2060R	851	1040	1187	29	29.5	60	20	102	4
L2ER2066R	907	1115	1272	29	29.5	66	20	110	6
L2ER2072R	961	1188	1364	29	29.5	72	20	119	6
L2ER2424R	504	592	658	29	29.5	24	24	55	3
L2ER2430R	562	668	746	29	29.5	30	24	63	3
L2ER2436R	626	750	851	29	29.5	36	24	70	3
L2ER2442R	692	836	949	29	29.5	42	24	77	3
L2ER2448R	750	912	1036	29	29.5	48	24	87	4
L2ER2454R	808	989	1128	29	29.5	54	24	92	4
L2ER2460R	883	1081	1232	29	29.5	60	24	102	4
L2ER2466R	941	1161	1326	29	29.5	66	24	110	6
L2ER2472R	999	1237	1421	29	29.5	72	24	119	6

**L2ERH-R • Executive Return Right, Half Modesty**

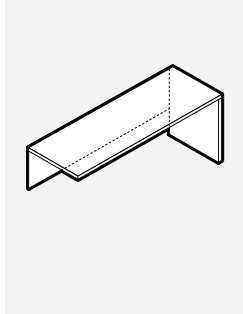

• Units are non-handed. They can be configured as either lefts or rights.

PRODUCT CODE	FINISH			SIZE/INCHES				WEIGHT LBS	VOL FT <sup>3</sup>
	LP	B	W	H (LP/B)	H (W)	W	D		
L2ERH2024R	419	497	562	29	29.5	24	20	45	3
L2ERH2030R	458	554	631	29	29.5	30	20	53	3
L2ERH2036R	601	625	719	29	29.5	36	20	62	3
L2ERH2042R	665	682	790	29	29.5	42	20	67	3
L2ERH2048R	722	741	860	29	29.5	48	20	77	4
L2ERH2054R	778	795	928	29	29.5	54	20	83	4
L2ERH2060R	851	870	1015	29	29.5	60	20	94	4
L2ERH2066R	905	925	1084	29	29.5	66	20	101	6
L2ERH2072R	961	984	1160	29	29.5	72	20	110	6
L2ERH2424R	433	517	584	29	29.5	24	24	45	3
L2ERH2430R	475	577	655	29	29.5	30	24	53	3
L2ERH2436R	530	648	749	29	29.5	36	24	62	3
L2ERH2442R	572	708	820	29	29.5	42	24	67	3
L2ERH2448R	615	768	895	29	29.5	48	24	77	4
L2ERH2454R	655	830	965	29	29.5	54	24	83	4
L2ERH2460R	712	903	1056	29	29.5	60	24	94	4
L2ERH2466R	754	964	1128	29	29.5	66	24	101	6
L2ERH2472R	795	1024	1208	29	29.5	72	24	110	6

**L2B • Bridge With Flush-Mounted Modesty**

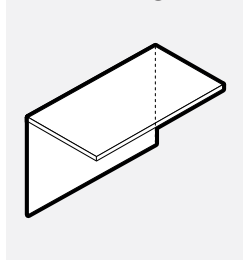

PRODUCT CODE	FINISH LP	B	W	SIZE / INCHES				WEIGHT LBS	VOL FT <sup>3</sup>
				H (LP/B)	H (W)	W	D		
L2B2024	334	409	476	29	29.5	24	20	39	2
L2B2030	389	482	563	29	29.5	30	20	42	3
L2B2036	449	563	658	29	29.5	36	20	68	3
L2B2042	506	637	745	29	29.5	42	20	77	3
L2B2048	562	711	832	29	29.5	48	20	86	4
L2B2054	619	787	918	29	29.5	54	20	94	4
L2B2424	347	426	496	29	29.5	24	24	39	2
L2B2430	405	502	588	29	29.5	30	24	44	3
L2B2436	469	584	684	29	29.5	36	24	68	3
L2B2442	525	663	776	29	29.5	42	24	77	3
L2B2448	584	741	865	29	29.5	48	24	86	4
L2B2454	642	816	954	29	29.5	54	24	94	4

**L2BH • Bridge With Flush-Mounted Half Modesty**

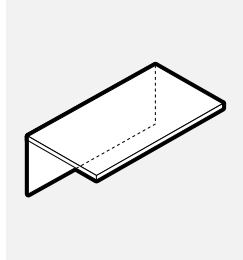

PRODUCT CODE	FINISH LP	B	W	SIZE / INCHES				WEIGHT LBS	VOL FT <sup>3</sup>
				H (LP/B)	H (W)	W	D		
L2BH2024	265	339	406	29	29.5	24	20	36	2
L2BH2030	306	395	475	29	29.5	30	20	36	2
L2BH2036	351	460	554	29	29.5	36	20	54	3
L2BH2042	389	517	625	29	29.5	42	20	61	3
L2BH2048	431	572	692	29	29.5	48	20	66	4
L2BH2054	471	631	762	29	29.5	54	20	72	4
L2BH2424	276	352	422	29	29.5	24	24	36	2
L2BH2430	318	410	492	29	29.5	30	24	42	3
L2BH2436	365	476	577	29	29.5	36	24	54	3
L2BH2442	406	538	648	29	29.5	42	24	61	3
L2BH2448	447	595	722	29	29.5	48	24	66	4
L2BH2454	489	655	794	29	29.5	54	24	72	4

**L2EC-R • Extended Corner Desk With 10" End Panel on Left, Full Modesty and Full Gable on Right**

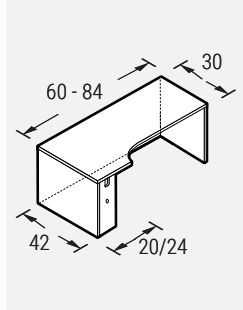

PRODUCT CODE	FINISH LP	B	W	SIZE / INCHES				WEIGHT LBS	VOL FT <sup>3</sup>
				H (LP/B)	H (W)	W	D		
<b>For 20" Return Connection</b>									
L2EC20426030R	1385	1713	1945	29	29.5	60	42	187	8
L2EC20426630R	1452	1814	2065	29	29.5	66	42	209	9
L2EC20427230R	1522	1910	2180	29	29.5	72	42	231	10
L2EC20427830R	1591	2011	2295	29	29.5	78	42	253	11
L2EC20428430R	1657	2107	2414	29	29.5	84	42	275	12
<b>For 24" Return Connection</b>									
L2EC24426030R	1385	1713	1945	29	29.5	60	42	187	8
L2EC24426630R	1452	1814	2065	29	29.5	66	42	209	9
L2EC24427230R	1522	1910	2180	29	29.5	72	42	231	10
L2EC24427830R	1591	2011	2295	29	29.5	78	42	253	11
L2EC24428430R	1657	2107	2414	29	29.5	84	42	275	12

**L2EC-L • Extended Corner Desk With 10" End Panel on Right, Full Modesty and Full Gable on Left**

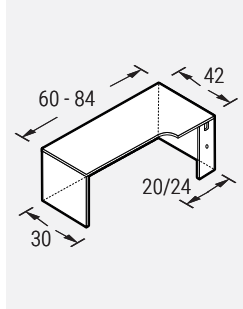

PRODUCT CODE	FINISH LP	B	W	SIZE / INCHES				WEIGHT LBS	VOL FT <sup>3</sup>
				H (LP/B)	H (W)	W	D		
<b>For 20" Return Connection</b>									
L2EC30604220L	1385	1713	1945	29	29.5	60	42	187	8
L2EC30664220L	1452	1814	2065	29	29.5	66	42	209	9
L2EC30724220L	1522	1910	2180	29	29.5	72	42	231	10
L2EC30784220L	1591	2011	2295	29	29.5	78	42	253	11
L2EC30844220L	1657	2107	2414	29	29.5	84	42	275	12
<b>For 24" Return Connection</b>									
L2EC30604224L	1385	1713	1945	29	29.5	60	42	187	8
L2EC30664224L	1452	1814	2065	29	29.5	66	42	209	9
L2EC30724224L	1522	1910	2180	29	29.5	72	42	231	10
L2EC30784224L	1591	2011	2295	29	29.5	78	42	253	11
L2EC30844224L	1657	2107	2414	29	29.5	84	42	275	12

**L2EC-R • Extended Corner Desk With 10" End Panel on Left, Full Modesty and Full Gable on Right**

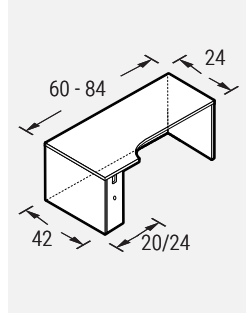

PRODUCT CODE	FINISH LP	B	W	SIZE/INCHES				WEIGHT LBS	VOL FT <sup>3</sup>
				H(LP/B)	H(W)	W	D		
<b>For 20" Return Connection</b>									
L2EC20426024R	1354	1686	1918	29	29.5	60	42	187	8
L2EC20426624R	1425	1783	2034	29	29.5	66	42	209	9
L2EC20427224R	1491	1882	2150	29	29.5	72	42	231	10
L2EC20427824R	1561	1981	2266	29	29.5	78	42	253	11
L2EC20428424R	1630	2079	2386	29	29.5	84	42	275	12
<b>For 24" Return Connection</b>									
L2EC24426024R	1354	1686	1918	29	29.5	60	42	187	8
L2EC24426624R	1425	1783	2034	29	29.5	66	42	209	9
L2EC24427224R	1491	1882	2150	29	29.5	72	42	231	10
L2EC24427824R	1561	1981	2266	29	29.5	78	42	253	11
L2EC24428424R	1630	2079	2386	29	29.5	84	42	275	12

**L2EC-L • Extended Corner Desk With 10" End Panel on Left, Full Modesty and Full Gable on Right**

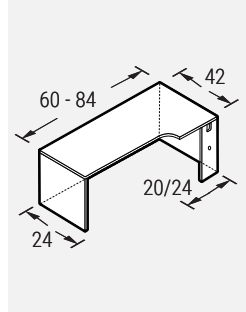

PRODUCT CODE	FINISH LP	B	W	SIZE/INCHES				WEIGHT LBS	VOL FT <sup>3</sup>
				H(LP/B)	H(W)	W	D		
<b>For 20" Return Connection</b>									
L2EC24604220L	1354	1686	1918	29	29.5	60	42	187	8
L2EC24664220L	1425	1783	2034	29	29.5	66	42	209	9
L2EC24724220L	1491	1882	2150	29	29.5	72	42	231	10
L2EC24784220L	1561	1981	2266	29	29.5	78	42	253	11
L2EC24844220L	1630	2079	2386	29	29.5	84	42	275	12
<b>For 24" Return Connection</b>									
L2EC24604224L	1354	1686	1918	29	29.5	60	42	187	8
L2EC24664224L	1425	1783	2034	29	29.5	66	42	209	9
L2EC24724224L	1491	1882	2150	29	29.5	72	42	231	10
L2EC24784224L	1561	1981	2266	29	29.5	78	42	253	11
L2EC24844224L	1630	2079	2386	29	29.5	84	42	275	12

**L2DEC-R • Extended Corner Desk With 10" End Panel on Left, Full Modesty and Full Gable Right**

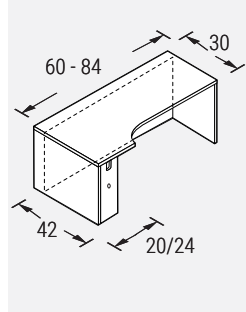

• All recessed modesties are inset 6" from the visitor edge.

PRODUCT CODE	FINISH LP	B	W	SIZE/INCHES				WEIGHT LBS	VOL FT <sup>3</sup>
				H(LP/B)	H(W)	W	D		
<b>For 20" Connection</b>									
L2DEC20426030R	1402	1738	1974	29	29.5	60	42	187	8
L2DEC20426630R	1474	1839	2094	29	29.5	66	42	209	9
L2DEC20427230R	1545	1938	2213	29	29.5	72	42	231	10
L2DEC20427830R	1612	2040	2330	29	29.5	78	42	253	11
L2DEC20428430R	1683	2138	2447	29	29.5	84	42	275	12
<b>For 24" Connection</b>									
L2DEC24426030R	1402	1738	1974	29	29.5	60	42	187	8
L2DEC24426630R	1474	1839	2094	29	29.5	66	42	209	9
L2DEC24427230R	1545	1938	2213	29	29.5	72	42	231	10
L2DEC24427830R	1612	2040	2330	29	29.5	78	42	253	11
L2DEC24428430R	1683	2138	2447	29	29.5	84	42	275	12

**L2DEC-L • Extended Corner Desk With 10" End Panel on Right, Full Modesty and Full Gable Left**

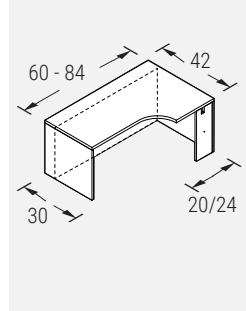

• All recessed modesties are inset 6" from the visitor edge.

PRODUCT CODE	FINISH LP	B	W	SIZE/INCHES				WEIGHT LBS	VOL FT <sup>3</sup>
				H(LP/B)	H(W)	W	D		
<b>For 20" Connection</b>									
L2DEC30604220L	1402	1738	1974	29	29.5	60	42	187	8
L2DEC30664220L	1474	1839	2094	29	29.5	66	42	209	9
L2DEC30724220L	1545	1938	2213	29	29.5	72	42	231	10
L2DEC30784220L	1612	2040	2330	29	29.5	78	42	253	11
L2DEC30844220L	1683	2138	2447	29	29.5	84	42	275	12
<b>For 24" Connection</b>									
L2DEC30604224L	1402	1738	1974	29	29.5	60	42	187	8
L2DEC30664224L	1474	1839	2094	29	29.5	66	42	209	9
L2DEC30724224L	1545	1938	2213	29	29.5	72	42	231	10
L2DEC30784224L	1612	2040	2330	29	29.5	78	42	253	11
L2DEC30844224L	1683	2138	2447	29	29.5	84	42	275	12

**L2DEC-R • Extended Corner Desk With 10" End Panel on Left, Full Modesty and Full Gable Right**

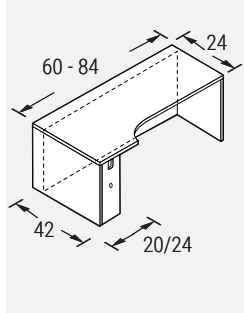

• All recessed modesties are inset 6" from the visitor edge.

PRODUCT CODE	FINISH			SIZE/INCHES				WEIGHT LBS	VOL FT <sup>3</sup>
	LP	B	W	H(LP/B)	H(W)	W	D		
<b>For 20" Connection</b>									
L2DEC20426024R	1377	1710	1944	29	29.5	60	42	187	8
L2DEC20426624R	1443	1810	2063	29	29.5	66	42	209	9
L2DEC20427224R	1513	1909	2182	29	29.5	72	42	231	10
L2DEC20427824R	1586	2011	2301	29	29.5	78	42	253	11
L2DEC20428424R	1652	2110	2420	29	29.5	84	42	275	12
<b>For 24" Connection</b>									
L2DEC24426024R	1377	1710	1944	29	29.5	60	42	187	8
L2DEC24426624R	1443	1810	2063	29	29.5	66	42	209	9
L2DEC24427224R	1513	1909	2182	29	29.5	72	42	231	10
L2DEC24427824R	1586	2011	2301	29	29.5	78	42	253	11
L2DEC24428424R	1652	2110	2420	29	29.5	84	42	275	12

**L2DEC-L • Extended Corner Desk With 10" End Panel on Right, Full Modesty and Full Gable Left**

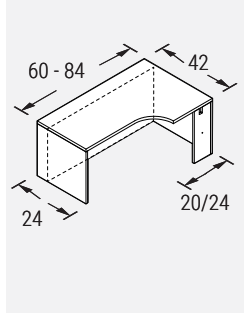

• All recessed modesties are inset 6" from the visitor edge.

PRODUCT CODE	FINISH			SIZE/INCHES				WEIGHT LBS	VOL FT <sup>3</sup>
	LP	B	W	H(LP/B)	H(W)	W	D		
<b>For 20" Connection</b>									
L2DEC24604220L	1377	1710	1944	29	29.5	60	42	187	8
L2DEC24664220L	1443	1810	2063	29	29.5	66	42	209	9
L2DEC24724220L	1513	1909	2182	29	29.5	72	42	231	10
L2DEC24784220L	1586	2011	2301	29	29.5	78	42	253	11
L2DEC24844220L	1652	2110	2420	29	29.5	84	42	275	12
<b>For 24" Connection</b>									
L2DEC24604224L	1377	1710	1944	29	29.5	60	42	187	8
L2DEC24664224L	1443	1810	2063	29	29.5	66	42	209	9
L2DEC24724224L	1513	1909	2182	29	29.5	72	42	231	10
L2DEC24784224L	1586	2011	2301	29	29.5	78	42	253	11
L2DEC24844224L	1652	2110	2420	29	29.5	84	42	275	12

**L2CS • Corner With Straight Front, Full Back Panel and Narrow End Gables**

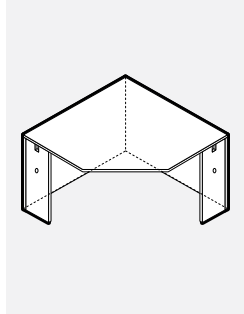

• For grain direction on surfaces larger than 42", please see grain direction chart at beginning of the Price List

PRODUCT CODE	FINISH			SIZE/INCHES				WEIGHT LBS	VOL FT <sup>3</sup>
	LP	B	W	H(LP/B)	H(W)	W	D		
L2CS183618	1107	1367	1707	29	29.5	36	36	79	3
L2CS183620	1135	1398	1752	29	29.5	36	36	84	3
L2CS183624	1135	1398	1752	29	29.5	36	36	84	3
L2CS203618	1135	1398	1752	29	29.5	36	36	84	3
L2CS203620	1181	1475	1899	29	29.5	36	36	88	3
L2CS203624	1210	1509	1942	29	29.5	36	36	88	3
L2CS243618	1135	1398	1752	29	29.5	36	36	84	3
L2CS243620	1210	1509	1942	29	29.5	36	36	88	3
L2CS243624	1210	1509	1942	29	29.5	36	36	88	3
L2CS184218	1214	1501	1863	29	29.5	42	42	87	4
L2CS184220	1247	1537	1910	29	29.5	42	42	92	4
L2CS184224	1247	1537	1910	29	29.5	42	42	92	4
L2CS204218	1247	1537	1910	29	29.5	42	42	92	4
L2CS204220	1247	1537	1910	29	29.5	42	42	97	4
L2CS204224	1275	1575	2017	29	29.5	42	42	97	4
L2CS244218	1247	1537	1910	29	29.5	42	42	92	4
L2CS244220	1275	1575	2017	29	29.5	42	42	97	4
L2CS244224	1275	1575	2017	29	29.5	42	42	97	4
L2CS184818	1286	1572	1936	29	29.5	48	48	97	6
L2CS184820	1317	1610	1984	29	29.5	48	48	101	6
L2CS184824	1317	1610	1984	29	29.5	48	48	101	6
L2CS204818	1317	1610	1984	29	29.5	48	48	101	6
L2CS204820	1317	1610	1984	29	29.5	48	48	107	6
L2CS204824	1349	1648	2089	29	29.5	48	48	107	6
L2CS244818	1317	1610	1984	29	29.5	48	48	101	6
L2CS244820	1349	1648	2089	29	29.5	48	48	107	6
L2CS244824	1349	1648	2089	29	29.5	48	48	107	6



**L2CSH • Corner With Straight Front, Cut-Out Back Panel and Narrow End Gables**

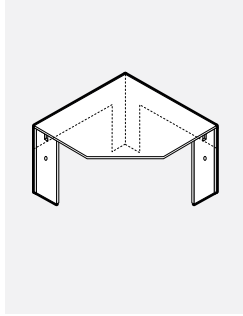

• For grain direction on surfaces larger than 42", please see grain direction chart at beginning of the Price List

PRODUCT CODE	FINISH LP	B	W	SIZE / INCHES			D	WEIGHT LBS	VOL FT <sup>3</sup>
				H (LP/B)	H (W)	W			
L2CSH183618	1143	1403	1744	29	29.5	36	36	51	3
L2CSH183620	1176	1437	1790	29	29.5	36	36	55	3
L2CSH183624	1176	1437	1790	29	29.5	36	36	55	3
L2CSH203618	1176	1437	1790	29	29.5	36	36	55	3
L2CSH203620	1221	1512	1938	29	29.5	36	36	59	3
L2CSH203624	1248	1549	1981	29	29.5	36	36	59	3
L2CSH243618	1176	1437	1790	29	29.5	36	36	55	3
L2CSH243620	1248	1549	1981	29	29.5	36	36	59	3
L2CSH243624	1248	1549	1981	29	29.5	36	36	59	3
L2CSH184218	1257	1545	1906	29	29.5	42	42	57	4
L2CSH184220	1290	1582	1957	29	29.5	42	42	63	4
L2CSH184224	1290	1582	1957	29	29.5	42	42	63	4
L2CSH204218	1290	1582	1957	29	29.5	42	42	63	4
L2CSH204220	1290	1582	1957	29	29.5	42	42	68	4
L2CSH204224	1319	1619	2063	29	29.5	42	42	68	4
L2CSH244218	1290	1582	1957	29	29.5	42	42	63	4
L2CSH244220	1319	1619	2063	29	29.5	42	42	68	4
L2CSH244224	1319	1619	2063	29	29.5	42	42	68	4
L2CSH184818	1348	1641	2009	29	29.5	48	48	65	6
L2CSH184820	1382	1678	2058	29	29.5	48	48	70	6
L2CSH184824	1382	1678	2058	29	29.5	48	48	70	6
L2CSH204818	1382	1678	2058	29	29.5	48	48	70	6
L2CSH204820	1382	1678	2058	29	29.5	48	48	76	6
L2CSH204824	1414	1718	2166	29	29.5	48	48	76	6
L2CSH244818	1382	1678	2058	29	29.5	48	48	70	6
L2CSH244820	1414	1718	2166	29	29.5	48	48	76	6
L2CSH244824	1414	1718	2166	29	29.5	48	48	76	6

**L2CC • Corner With Curved Front, Full Back Panel and Narrow End Gables**

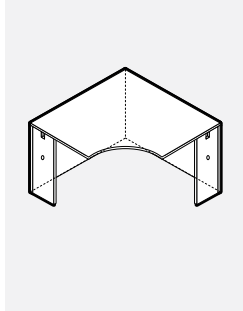

• For grain direction on surfaces larger than 42", please see grain direction chart at beginning of the Price List

PRODUCT CODE	FINISH LP	B	W	SIZE / INCHES			D	WEIGHT LBS	VOL FT <sup>3</sup>
				H (LP/B)	H (W)	W			
L2CC183618	1123	1388	1740	29	29.5	36	36	79	3
L2CC183620	1153	1425	1785	29	29.5	36	36	84	3
L2CC183624	1153	1425	1785	29	29.5	36	36	84	3
L2CC203618	1153	1425	1785	29	29.5	36	36	84	3
L2CC203620	1199	1504	1938	29	29.5	36	36	88	3
L2CC203624	1226	1536	1981	29	29.5	36	36	88	3
L2CC243618	1153	1425	1785	29	29.5	36	36	84	3
L2CC243620	1226	1536	1981	29	29.5	36	36	88	3
L2CC243624	1226	1536	1981	29	29.5	36	36	88	3
L2CC184218	1230	1526	1901	29	29.5	42	42	87	4
L2CC184220	1263	1565	1950	29	29.5	42	42	92	4
L2CC184224	1263	1565	1950	29	29.5	42	42	92	4
L2CC204218	1263	1565	1950	29	29.5	42	42	92	4
L2CC204220	1263	1565	1950	29	29.5	42	42	97	4
L2CC204224	1296	1604	2058	29	29.5	42	42	97	4
L2CC244218	1263	1565	1950	29	29.5	42	42	92	4
L2CC244220	1296	1604	2058	29	29.5	42	42	97	4
L2CC244224	1296	1604	2058	29	29.5	42	42	97	4
L2CC184818	1321	1620	2003	29	29.5	48	48	97	6
L2CC184820	1353	1661	2052	29	29.5	48	48	101	6
L2CC184824	1353	1661	2052	29	29.5	48	48	101	6
L2CC204818	1353	1661	2052	29	29.5	48	48	101	6
L2CC204820	1388	1700	2160	29	29.5	48	48	107	6
L2CC204824	1388	1700	2160	29	29.5	48	48	107	6
L2CC244818	1353	1661	2052	29	29.5	48	48	101	6
L2CC244820	1388	1700	2160	29	29.5	48	48	107	6
L2CC244824	1388	1700	2160	29	29.5	48	48	107	6

**L2CCH • Corner With Curved Front, Cut-Out Back Panel and Narrow End Gables**

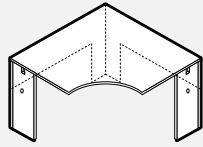

• For grain direction on surfaces larger than 42", please see grain direction chart at beginning of the Price List

PRODUCT CODE	FINISH			SIZE / INCHES				WEIGHT		VOL FT <sup>3</sup>
	LP	B	W	H (LP/B)	H (W)	W	D	LBS		
L2CCH183618	1161	1426	1903	29	29.5	36	36	51	3	
L2CCH183620	1191	1463	1909	29	29.5	36	36	55	3	
L2CCH183624	1191	1463	1909	29	29.5	36	36	55	3	
L2CCH203618	1191	1463	1909	29	29.5	36	36	55	3	
L2CCH203620	1237	1540	2067	29	29.5	36	36	59	3	
L2CCH203624	1267	1575	2067	29	29.5	36	36	59	3	
L2CCH243618	1191	1463	1909	29	29.5	36	36	55	3	
L2CCH243620	1267	1575	2067	29	29.5	36	36	59	3	
L2CCH243624	1267	1575	2067	29	29.5	36	36	59	3	
L2CCH184218	1274	1569	1943	29	29.5	42	42	57	4	
L2CCH184220	1308	1608	1993	29	29.5	42	42	63	4	
L2CCH184224	1308	1608	1993	29	29.5	42	42	63	4	
L2CCH204218	1308	1608	1993	29	29.5	42	42	63	4	
L2CCH204220	1308	1608	1993	29	29.5	42	42	68	4	
L2CCH204224	1339	1648	2100	29	29.5	42	42	68	4	
L2CCH244218	1308	1608	1993	29	29.5	42	42	63	4	
L2CCH244220	1339	1648	2100	29	29.5	42	42	68	4	
L2CCH244224	1339	1648	2100	29	29.5	42	42	68	4	
L2CCH184818	1375	1666	2046	29	29.5	48	48	65	6	
L2CCH184820	1399	1705	2096	29	29.5	48	48	70	6	
L2CCH184824	1399	1705	2096	29	29.5	48	48	70	6	
L2CCH204818	1399	1705	2096	29	29.5	48	48	70	6	
L2CCH204820	1399	1705	2096	29	29.5	48	48	76	6	
L2CCH204824	1432	1745	2204	29	29.5	48	48	76	6	
L2CCH244818	1399	1705	2096	29	29.5	48	48	70	6	
L2CCH244820	1432	1745	2204	29	29.5	48	48	76	6	
L2CCH244824	1432	1745	2204	29	29.5	48	48	76	6	

**L2CK • Split Corner Desk With Curved Front Keyboard, Full Back Panel and Narrow End Gables**

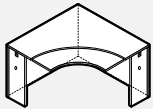

• For grain direction on surfaces larger than 42", please see grain direction chart at beginning of the Price List

PRODUCT CODE	FINISH			SIZE / INCHES				WEIGHT		VOL FT <sup>3</sup>
	LP	B	W	H (LP/B)	H (W)	W	D	LBS		
L2CK244224	2203	2586	3067	29	29.5	42	42	97	4	
L2CK244824	2309	2698	3186	29	29.5	48	48	107	6	

**L2CHK • Split Corner Desk With Curved Front Keyboard, Cut-Out Back Panel and Narrow End Gables**

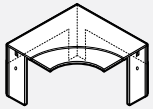

• For grain direction on surfaces larger than 42", please see grain direction chart at beginning of the Price List

PRODUCT CODE	FINISH			SIZE / INCHES				WEIGHT		VOL FT <sup>3</sup>
	LP	B	W	H (LP/B)	H (W)	W	D	LBS		
L2CHK244224	2246	2607	3089	29	29.5	42	42	68	4	
L2CHK244824	2353	2720	3207	29	29.5	48	48	76	6	

## TECHNICAL INFORMATION

- All Shaped tables are Shipped knocked down (KD).
- Monoleg or square leg ships in a separate box.
- All Units must be connected to an adjoining unit with flat brackets.
- For 24" deep returns that connect to an adjoining unit with included flat brackets.
- For 24" deep returns that connect to the corner units, the narrow panel is 10" and for 30" deep returns, the narrow panel is 14".
- All bottom edges are edge banded.
- Monolegs are drilled to accept shoulder screws to attach to the modesty.
- Modesty are offered 10" high only.
- Top plate with cut-out for 3" monoleg will accept modesty panel 1" thick.
- 8 x 8" plate is attached to surface with #10 3/4 wood screws, included.
- 1" height adjustment range.

## TABLES • GUIDELINES FOR ORDERING PRODUCT

**CODES:** The price list uses a numbering system with meaningful alphanumeric characters to create a simple-to-understand product number. This makes specifying the product much easier and more accurate.

### SPECIFICATION EXAMPLE OF A SHAPED TABLE

**PRODUCT CODE:**

L2TDH3060  
 L2 = New Licence  
 T = Table  
 D = D Shape Worksurface  
 H = Half Modesty (10"High)  
 3060 = Size: Depth x Width

**OPTIONS:**

Top: LP - LPL (Low Pressure Laminate) Thickness 1"  
 HP B - B Thickness 1 1/16"  
 HP W - W Thickness 1 7/16"

Leg Option: L2BHML03 (DEFAULT) Round Monoleg  
 L2LSQ3X3 - Square Leg

Top Finish Laminate: Choose Color

Top PVC Edging: Choose Color

Chassis Laminate: Choose Color

Chassis PVC Edging: Choose Color

Metal Leg Finish: Choose Color

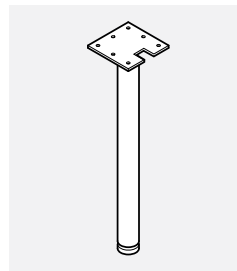

L2BHML03

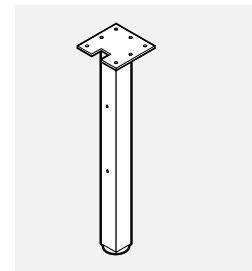

L2LSQ3X3

## L2TD • D-Shaped Top With T-Base and Leg

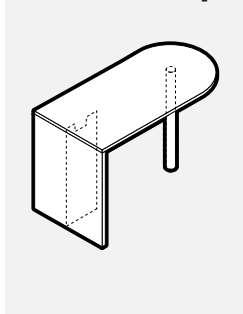

• Add \$103 to list price for chrome leg option.

PRODUCT CODE	FINISH		SIZE/INCHES				WEIGHT		VOL FT <sup>3</sup>
	LP	B	W	H (LP/B)	H(W)	W	D	LBS	
L2TD2442	973	1127	1237	29	29.5	42	24	64	3
L2TD2448	1002	1170	1294	29	29.5	48	24	68	3
L2TD2454	1030	1215	1350	29	29.5	54	24	72	3
L2TD2460	1057	1261	1408	29	29.5	60	24	76	4
L2TD2466	1086	1304	1466	29	29.5	66	24	79	4
L2TD2472	1113	1349	1524	29	29.5	72	24	84	4
L2TD2478	1142	1392	1578	29	29.5	78	24	87	6
L2TD2484	1170	1437	1637	29	29.5	84	24	91	6
L2TD3054	1119	1343	1504	29	29.5	54	30	97	4
L2TD3060	1153	1396	1570	29	29.5	60	30	107	7
L2TD3066	1187	1450	1641	29	29.5	66	30	117	8
L2TD3072	1221	1505	1707	29	29.5	72	30	127	9
L2TD3078	1256	1558	1776	29	29.5	78	30	136	9
L2TD3084	1289	1612	1846	29	29.5	84	30	146	10
L2TD3654	1203	1463	1645	29	29.5	54	36	107	4
L2TD3660	1241	1528	1725	29	29.5	60	36	111	10
L2TD3666	1278	1592	1807	29	29.5	66	36	116	9
L2TD3672	1317	1653	1884	29	29.5	72	36	153	10
L2TD3678	1356	1720	1965	29	29.5	78	36	165	11
L2TD3684	1394	1780	2042	29	29.5	84	36	176	12

**L2TDH • D-Shaped Top With Half Modesty and Leg**

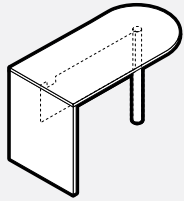

• Add \$103 to list price for chrome leg option.

PRODUCT CODE	FINISH			SIZE / INCHES				WEIGHT LBS	VOL FT <sup>3</sup>
	LP	B	W	H (LP/B)	H (W)	W	D		
L2TDH2442	954	1105	1218	29	29.5	42	24	63	3
L2TDH2448	995	1164	1286	29	29.5	48	24	69	3
L2TDH2454	1035	1219	1354	29	29.5	54	24	75	3
L2TDH2460	1073	1275	1426	29	29.5	60	24	81	4
L2TDH2466	1115	1334	1494	29	29.5	66	24	87	4
L2TDH2472	1155	1391	1565	29	29.5	72	24	94	4
L2TDH2478	1192	1446	1636	29	29.5	78	24	99	6
L2TDH2484	1232	1505	1702	29	29.5	84	24	106	6
L2TDH3054	1122	1343	1504	29	29.5	54	30	95	4
L2TDH3060	1166	1408	1583	29	29.5	60	30	102	7
L2TDH3066	1211	1478	1663	29	29.5	66	30	112	8
L2TDH3072	1257	1545	1744	29	29.5	72	30	122	9
L2TDH3078	1301	1610	1825	29	29.5	78	30	132	9
L2TDH3084	1346	1677	1909	29	29.5	84	30	142	10
L2TDH3654	1203	1466	1646	29	29.5	54	36	145	4
L2TDH3660	1256	1540	1737	29	29.5	60	36	151	10
L2TDH3666	1292	1604	1818	29	29.5	66	36	154	9
L2TDH3672	1343	1679	1909	29	29.5	72	36	156	10
L2TDH3678	1392	1755	2003	29	29.5	78	36	161	11
L2TDH3684	1445	1830	2095	29	29.5	84	36	172	12

**L2TR • Rectangular Top With T-Base and Mono Leg**

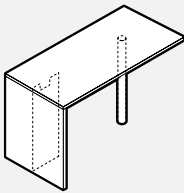

• Add \$103 to list price for chrome leg option.

PRODUCT CODE	FINISH			SIZE / INCHES				WEIGHT LBS	VOL FT <sup>3</sup>
	LP	B	W	H (LP/B)	H (W)	W	D		
L2TR2442	1040	1199	1317	29	29.5	42	24	64	3
L2TR2448	1065	1246	1378	29	29.5	48	24	68	3
L2TR2454	1097	1294	1440	29	29.5	54	24	72	3
L2TR2460	1128	1342	1502	29	29.5	60	24	76	4
L2TR2466	1157	1388	1560	29	29.5	66	24	79	4
L2TR2472	1184	1437	1624	29	29.5	72	24	84	4
L2TR2478	1218	1484	1683	29	29.5	78	24	87	6
L2TR2484	1246	1532	1745	29	29.5	84	24	91	6
L2TR3054	1191	1430	1601	29	29.5	54	30	97	4
L2TR3060	1227	1488	1674	29	29.5	60	30	107	7
L2TR3066	1265	1547	1748	29	29.5	66	30	112	8
L2TR3072	1300	1602	1818	29	29.5	72	30	127	9
L2TR3078	1337	1661	1893	29	29.5	78	30	136	9
L2TR3084	1373	1718	1966	29	29.5	84	30	146	10
L2TR3654	1279	1558	1753	29	29.5	54	36	107	4
L2TR3660	1321	1630	1837	29	29.5	60	36	111	7
L2TR3666	1361	1694	1925	29	29.5	66	36	116	8
L2TR3672	1403	1763	2007	29	29.5	72	36	153	9
L2TR3678	1445	1829	2093	29	29.5	78	36	165	9
L2TR3684	1485	1898	2177	29	29.5	84	36	176	10

**L2TRH • Rectangular Top With Half Modesty and Mono Leg**

• Add \$103 to list price for chrome leg option.

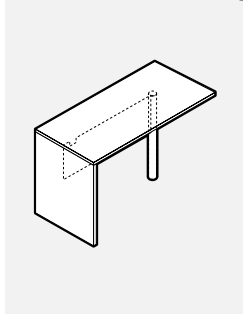

PRODUCT CODE	FINISH LP	B	W	SIZE/INCHES				WEIGHT LBS	VOL FT <sup>3</sup>
				H (L/P/B)	H (W)	W	D		
L2TRH2442	1015	1177	1296	29	29.5	42	24	63	3
L2TRH2448	1059	1237	1382	29	29.5	48	24	69	3
L2TRH2454	1101	1297	1443	29	29.5	54	24	75	3
L2TRH2460	1143	1359	1517	29	29.5	60	24	81	4
L2TRH2466	1187	1421	1593	29	29.5	66	24	87	4
L2TRH2472	1229	1482	1668	29	29.5	72	24	94	4
L2TRH2478	1272	1543	1740	29	29.5	78	24	99	6
L2TRH2484	1313	1602	1814	29	29.5	84	24	100	6
L2TRH3054	1192	1430	1601	29	29.5	54	30	95	4
L2TRH3060	1241	1502	1686	29	29.5	60	30	102	7
L2TRH3066	1290	1572	1772	29	29.5	66	30	112	8
L2TRH3072	1338	1645	1858	29	29.5	72	30	132	9
L2TRH3078	1386	1717	1944	29	29.5	78	30	142	9
L2TRH3084	1436	1783	2033	29	29.5	84	30	145	10
L2TRH3654	1279	1560	1754	29	29.5	54	36	145	4
L2TRH3660	1337	1641	1851	29	29.5	60	36	151	7
L2TRH3666	1377	1710	1937	29	29.5	66	36	154	8
L2TRH3672	1430	1790	2033	29	29.5	72	36	156	9
L2TRH3678	1484	1868	2133	29	29.5	78	36	161	9
L2TRH3684	1540	1950	2233	29	29.5	84	36	172	10

**L2TA • Axe-Shaped Top With T-Base and Leg**

• Add \$103 to list price for chrome leg option.

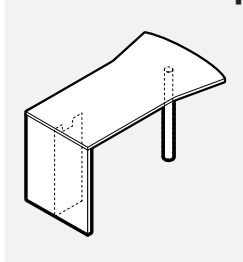

PRODUCT CODE	FINISH LP	B	W	SIZE/INCHES				WEIGHT LBS	VOL FT <sup>3</sup>
				H (L/P/B)	H (W)	W	D		
L2TA3060	1278	1605	1829	29	29.50	60	42	131	10
L2TA3066	1324	1679	1923	29	29.50	66	42	140	11
L2TA3072	1369	1752	2014	29	29.50	72	42	149	12
L2TA3078	1413	1823	2104	29	29.50	78	42	157	12
L2TA3084	1456	1898	2200	29	29.50	84	42	166	13
L2TA3672	1466	1900	2188	29	29.50	72	48	153	13
L2TA3678	1515	1982	2294	29	29.50	78	48	163	14
L2TA3684	1564	2066	2396	29	29.50	84	48	173	15

**L2TAH • Axe-Shaped Top With Half Modesty and Leg**

• Add \$103 to list price for chrome leg option.

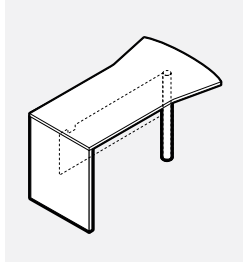

PRODUCT CODE	FINISH LP	B	W	SIZE/INCHES				WEIGHT LBS	VOL FT <sup>3</sup>
				H (L/P/B)	H (W)	W	D		
L2TAH3060	1292	1618	1846	29	29.50	60	42	127	10
L2TAH3066	1346	1702	1947	29	29.50	66	42	135	11
L2TAH3072	1403	1788	2051	29	29.50	72	42	144	12
L2TAH3078	1459	1877	2155	29	29.50	78	42	153	12
L2TAH3084	1515	1961	2258	29	29.50	84	42	162	13
L2TAH3672	1490	1926	2217	29	29.50	72	48	149	13
L2TAH3678	1553	2022	2332	29	29.50	78	48	158	14
L2TAH3684	1612	2117	2445	29	29.50	84	48	168	15

**L2TP-L • P-Shaped Top Left With T-Base and Leg**

• Add \$103 to list price for chrome leg option.

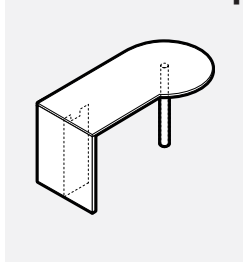

PRODUCT CODE	FINISH LP	B	W	SIZE/INCHES				WEIGHT LBS	VOL FT <sup>3</sup>
				H (L/P/B)	H (W)	W	D		
L2TP3060L	1219	1505	1707	29	29.50	60	36	121	9
L2TP3066L	1259	1569	1785	29	29.50	66	36	135	9
L2TP3072L	1297	1632	1867	29	29.50	72	36	150	10
L2TP3078L	1335	1695	1945	29	29.50	78	36	164	11
L2TP3084L	1376	1761	2026	29	29.50	84	36	178	12
L2TP3672L	1394	1780	2042	29	29.50	72	42	188	12
L2TP3678L	1441	1853	2134	29	29.50	78	42	202	12
L2TP3684L	1484	1927	2225	29	29.50	84	42	217	13

**L2TP-R • P-Shaped Top Right With T-Base and Leg**

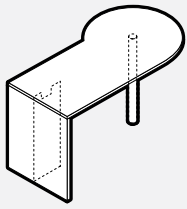

• Add \$103 to list price for chrome leg option.

PRODUCT CODE	FINISH LP	B	W	SIZE / INCHES				WEIGHT LBS	VOL FT <sup>3</sup>
				H (LP/B)	H (W)	W	D		
L2TP3060R	1219	1505	1707	29	29.50	60	36	121	9
L2TP3066R	1259	1569	1785	29	29.50	66	36	135	9
L2TP3072R	1297	1632	1867	29	29.50	72	36	150	10
L2TP3078R	1335	1695	1945	29	29.50	78	36	164	11
L2TP3084R	1376	1761	2026	29	29.50	84	36	178	12
L2TP3672R	1394	1780	2042	29	29.50	72	42	188	12
L2TP3678R	1441	1853	2134	29	29.50	78	42	202	12
L2TP3684R	1484	1927	2225	29	29.50	84	42	217	13

**L2TPH-L • P-Shaped Top Left With Half Modesty and Leg**

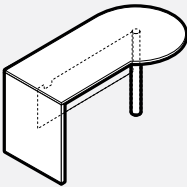

• Add \$103 to list price for chrome leg option.

PRODUCT CODE	FINISH LP	B	W	SIZE / INCHES				WEIGHT LBS	VOL FT <sup>3</sup>
				H (LP/B)	H (W)	W	D		
L2TPH3060L	1230	1516	1720	29	29.50	60	36	117	9
L2TPH3066L	1279	1592	1812	29	29.50	66	36	131	9
L2TPH3072L	1334	1668	1903	29	29.50	72	36	145	10
L2TPH3078L	1383	1744	1996	29	29.50	78	36	160	11
L2TPH3084L	1434	1819	2089	29	29.50	84	36	174	12
L2TPH3672L	1419	1807	2067	29	29.50	72	42	184	12
L2TPH3678L	1474	1890	2173	29	29.50	78	42	198	12
L2TPH3684L	1529	1976	2276	29	29.50	84	42	212	13

**L2TPH-R • P-Shaped Top Right With Half Modesty and Leg**

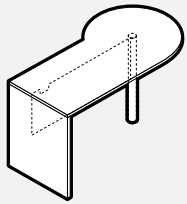

• Add \$103 to list price for chrome leg option.

PRODUCT CODE	FINISH LP	B	W	SIZE / INCHES				WEIGHT LBS	VOL FT <sup>3</sup>
				H (LP/B)	H (W)	W	D		
L2TPH3060R	1230	1516	1720	29	29.50	60	36	117	9
L2TPH3066R	1279	1592	1812	29	29.50	66	36	131	9
L2TPH3072R	1334	1668	1903	29	29.50	72	36	145	10
L2TPH3078R	1383	1744	1996	29	29.50	78	36	160	11
L2TPH3084R	1434	1819	2089	29	29.50	84	36	174	12
L2TPH3672R	1419	1807	2067	29	29.50	72	42	184	12
L2TPH3678R	1474	1890	2173	29	29.50	78	42	198	12
L2TPH3684R	1529	1976	2276	29	29.50	84	42	212	13

**L2TH-L • Hockey-Shaped Top Left With T-Base and Leg**

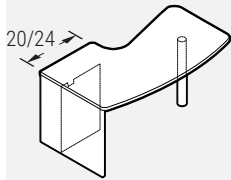

• Add \$103 to list price for chrome leg option.

PRODUCT CODE	FINISH LP	B	W	SIZE / INCHES				WEIGHT LBS	VOL FT <sup>3</sup>
				H (LP/B)	H (W)	W	D		
<b>For 20" Return Connection</b>									
L2TH203060L	1268	1561	1781	29	29.50	60	36	121	9
L2TH203066L	1308	1624	1863	29	29.50	66	36	135	9
L2TH203072L	1346	1690	1943	29	29.50	72	36	150	10
L2TH203078L	1387	1753	2026	29	29.50	78	36	164	11
L2TH203084L	1426	1819	2107	29	29.50	84	36	178	12
L2TH203660L	1356	1694	1939	29	29.50	60	42	188	10
L2TH203666L	1403	1769	2034	29	29.50	66	42	202	11
L2TH203672L	1448	1844	2126	29	29.50	72	42	217	12
L2TH203678L	1494	1918	2220	29	29.50	78	42	220	12
L2TH203684L	1537	1991	2312	29	29.50	84	42	237	13
<b>For 24" Return Connection</b>									
L2TH3060L	1268	1561	1781	29	29.50	60	36	121	9
L2TH3066L	1308	1624	1863	29	29.50	66	36	135	9
L2TH3072L	1346	1690	1943	29	29.50	72	36	150	10
L2TH3078L	1387	1753	2026	29	29.50	78	36	164	11
L2TH3084L	1426	1819	2107	29	29.50	84	36	178	12
L2TH3660L	1356	1694	1939	29	29.50	60	42	188	10
L2TH3666L	1403	1769	2034	29	29.50	66	42	202	11
L2TH3672L	1448	1844	2126	29	29.50	72	42	217	12
L2TH3678L	1494	1918	2220	29	29.50	78	42	220	12
L2TH3684L	1537	1991	2312	29	29.50	84	42	237	13

**L2TH-R • Hockey-Shaped Top Right With T-Base and Leg**

• Add \$103 to list price for chrome leg option.

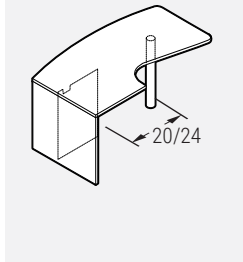

PRODUCT CODE	FINISH LP	B	W	SIZE/INCHES				WEIGHT LBS	VOL FT <sup>3</sup>
				H(LP/B)	H(W)	W	D		
<b>For 20" Return Connection</b>									
L2TH203060R	1268	1561	1781	29	29.50	60	36	121	9
L2TH203066R	1308	1624	1863	29	29.50	66	36	135	9
L2TH203072R	1346	1690	1943	29	29.50	72	36	150	10
L2TH203078R	1387	1753	2026	29	29.50	78	36	164	11
L2TH203084R	1426	1819	2107	29	29.50	84	36	178	12
L2TH203660R	1356	1694	1939	29	29.50	60	42	188	10
L2TH203666R	1403	1769	2034	29	29.50	66	42	202	11
L2TH203672R	1448	1844	2126	29	29.50	72	42	217	12
L2TH203678R	1494	1918	2220	29	29.50	78	42	220	12
L2TH203684R	1537	1991	2312	29	29.50	84	42	237	13
<b>For 24" Return Connection</b>									
L2TH3060R	1268	1561	1781	29	29.50	60	36	121	9
L2TH3066R	1308	1624	1863	29	29.50	66	36	135	9
L2TH3072R	1346	1690	1943	29	29.50	72	36	150	10
L2TH3078R	1387	1753	2026	29	29.50	78	36	164	11
L2TH3084R	1426	1819	2107	29	29.50	84	36	178	12
L2TH3660R	1356	1694	1939	29	29.50	60	42	188	10
L2TH3666R	1403	1769	2034	29	29.50	66	42	202	11
L2TH3672R	1448	1844	2126	29	29.50	72	42	217	12
L2TH3678R	1494	1918	2220	29	29.50	78	42	220	12
L2TH3684R	1537	1991	2312	29	29.50	84	42	237	13

**L2THH-L • Hockey-Shaped Top Left With Half Modesty and Leg**

• Add \$103 to list price for chrome leg option.

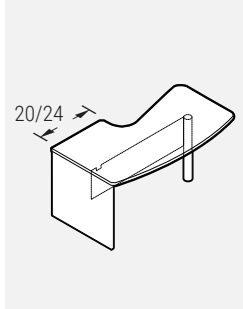

PRODUCT CODE	FINISH LP	B	W	SIZE/INCHES				WEIGHT LBS	VOL FT <sup>3</sup>
				H(LP/B)	H(W)	W	D		
<b>For 20" Return Connection</b>									
L2THH203060L	1279	1572	1794	29	29.50	60	36	117	9
L2THH203066L	1334	1650	1890	29	29.50	66	36	131	9
L2THH203072L	1385	1728	1984	29	29.50	72	36	145	10
L2THH203078L	1436	1807	2079	29	29.50	78	36	160	11
L2THH203084L	1488	1884	2173	29	29.50	84	36	174	12
L2THH203660L	1358	1694	1939	29	29.50	60	42	184	10
L2THH203666L	1418	1780	2046	29	29.50	66	42	198	11
L2THH203672L	1474	1867	2150	29	29.50	72	42	212	12
L2THH203678L	1532	1955	2258	29	29.50	78	42	220	12
L2THH203684L	1588	2042	2364	29	29.50	84	42	237	13
<b>For 24" Return Connection</b>									
L2THH3060L	1279	1572	1794	29	29.50	60	36	117	9
L2THH3066L	1334	1650	1890	29	29.50	66	36	131	9
L2THH3072L	1385	1728	1984	29	29.50	72	36	145	10
L2THH3078L	1436	1807	2079	29	29.50	78	36	160	11
L2THH3084L	1488	1884	2173	29	29.50	84	36	174	12
L2THH3660L	1358	1694	1939	29	29.50	60	42	184	10
L2THH3666L	1418	1780	2046	29	29.50	66	42	198	11
L2THH3672L	1474	1867	2150	29	29.50	72	42	212	12
L2THH3678L	1532	1955	2258	29	29.50	78	42	220	12
L2THH3684L	1588	2042	2364	29	29.50	84	42	237	13

**L2THH-R • Hockey-Shaped Top Right With Half Modesty and Leg**

• Add \$103 to list price for chrome leg option.

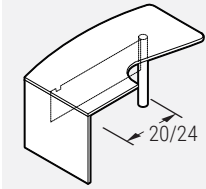

PRODUCT CODE	FINISH LP	B	W	SIZE / INCHES				WEIGHT LBS	VOL FT <sup>3</sup>
				H (LP/B)	H (W)	W	D		
<b>For 20" Return Connection</b>									
L2THH203060R	1279	1572	1794	29	29.50	60	36	117	9
L2THH203066R	1334	1650	1890	29	29.50	66	36	131	9
L2THH203072R	1385	1728	1984	29	29.50	72	36	145	10
L2THH203078R	1436	1807	2079	29	29.50	78	36	160	11
L2THH203084R	1488	1884	2173	29	29.50	84	36	174	12
L2THH203660R	1358	1694	1939	29	29.50	60	42	184	10
L2THH203666R	1418	1780	2046	29	29.50	66	42	198	11
L2THH203672R	1474	1867	2150	29	29.50	72	42	212	12
L2THH203678R	1532	1955	2258	29	29.50	78	42	220	12
L2THH203684R	1588	2042	2364	29	29.50	84	42	237	13
<b>For 24" Return Connection</b>									
L2THH3060R	1279	1572	1794	29	29.50	60	36	117	9
L2THH3066R	1334	1650	1890	29	29.50	66	36	131	9
L2THH3072R	1385	1728	1984	29	29.50	72	36	145	10
L2THH3078R	1436	1807	2079	29	29.50	78	36	160	11
L2THH3084R	1488	1884	2173	29	29.50	84	36	174	12
L2THH3660R	1358	1694	1939	29	29.50	60	42	184	10
L2THH3666R	1418	1780	2046	29	29.50	66	42	198	11
L2THH3672R	1474	1867	2150	29	29.50	72	42	212	12
L2THH3678R	1532	1955	2258	29	29.50	78	42	220	12
L2THH3684R	1588	2042	2364	29	29.50	84	42	237	13

**L2TEDH-L • Extended "D" With Half Modesty and Leg**

• Add \$103 to list price for chrome leg option.

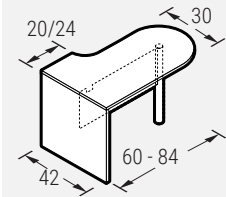

PRODUCT CODE	FINISH LP	B	W	SIZE / INCHES				WEIGHT LBS	VOL FT <sup>3</sup>
				H (LP/B)	H (W)	W	D		
<b>For 20" Return Connection</b>									
L2TEDH603020L	1388	1653	1894	29	29.50	60	42	110	8
L2TEDH663020L	1446	1737	1996	29	29.50	66	42	121	9
L2TEDH723020L	1505	1821	2099	29	29.50	72	42	132	10
L2TEDH783020L	1563	1906	2201	29	29.50	78	42	143	11
L2TEDH843020L	1618	1991	2304	29	29.50	84	42	154	12
<b>For 24" Return Connection</b>									
L2TEDH603024L	1388	1653	1894	29	29.50	60	42	110	8
L2TEDH663024L	1446	1737	1996	29	29.50	66	42	121	9
L2TEDH723024L	1505	1821	2099	29	29.50	72	42	132	10
L2TEDH783024L	1563	1906	2201	29	29.50	78	42	143	11
L2TEDH843024L	1618	1991	2304	29	29.50	84	42	154	12

**L2TED-L • Extended "D" With T-Base and Leg**

• Add \$103 to list price for chrome leg option.

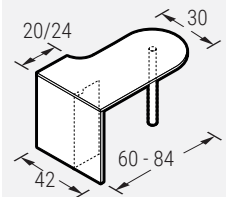

PRODUCT CODE	FINISH LP	B	W	SIZE / INCHES				WEIGHT LBS	VOL FT <sup>3</sup>
				H (LP/B)	H (W)	W	D		
<b>For 20" Return Connection</b>									
L2TED603020L	1376	1621	1860	29	29.50	60	42	110	8
L2TED663020L	1421	1694	1947	29	29.50	66	42	121	9
L2TED723020L	1466	1766	2039	29	29.50	72	42	132	10
L2TED783020L	1511	1836	2130	29	29.50	78	42	143	11
L2TED843020L	1556	1906	2218	29	29.50	84	42	154	12
<b>For 24" Return Connection</b>									
L2TED603024L	1376	1621	1860	29	29.50	60	42	110	8
L2TED663024L	1421	1694	1947	29	29.50	66	42	121	9
L2TED723024L	1466	1766	2039	29	29.50	72	42	132	10
L2TED783024L	1511	1836	2130	29	29.50	78	42	143	11
L2TED843024L	1556	1906	2218	29	29.50	84	42	154	12



**L2TEDH-R • Extended “D” With Half Modesty and Leg**

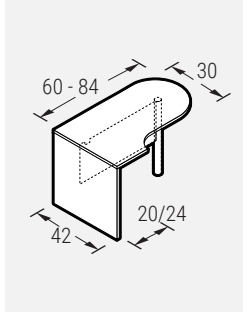

• Add \$103 to list price for chrome leg option.

PRODUCT CODE	FINISH LP	B	W	SIZE / INCHES			D	WEIGHT LBS	VOL FT <sup>3</sup>
				H (LP/B)	H (W)	W			
<b>For 20" Return Connection</b>									
L2TEDH603020R	1388	1653	1894	29	29.50	60	42	110	8
L2TEDH663020R	1446	1737	1996	29	29.50	66	42	121	9
L2TEDH723020R	1505	1821	2099	29	29.50	72	42	132	10
L2TEDH783020R	1563	1906	2201	29	29.50	78	42	143	11
L2TEDH843020R	1618	1991	2304	29	29.50	84	42	154	12
<b>For 24" Return Connection</b>									
L2TEDH603024R	1388	1653	1894	29	29.50	60	42	110	8
L2TEDH663024R	1446	1737	1996	29	29.50	66	42	121	9
L2TEDH723024R	1505	1821	2099	29	29.50	72	42	132	10
L2TEDH783024R	1563	1906	2201	29	29.50	78	42	143	11
L2TEDH843024R	1618	1991	2304	29	29.50	84	42	154	12

**L2TED-R • Extended “D” With T-Base and Leg**

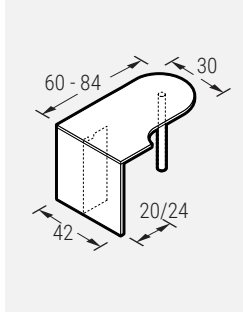

• Add \$103 to list price for chrome leg option.

PRODUCT CODE	FINISH LP	B	W	SIZE / INCHES			D	WEIGHT LBS	VOL FT <sup>3</sup>
				H (LP/B)	H (W)	W			
<b>For 20" Return Connection</b>									
L2TED603020R	1376	1621	1860	29	29.50	60	42	110	8
L2TED663020R	1421	1694	1947	29	29.50	66	42	121	9
L2TED723020R	1466	1766	2039	29	29.50	72	42	132	10
L2TED783020R	1511	1836	2130	29	29.50	78	42	143	11
L2TED843020R	1556	1906	2218	29	29.50	84	42	154	12
<b>For 24" Return Connection</b>									
L2TED603024R	1376	1621	1860	29	29.50	60	42	110	8
L2TED663024R	1421	1694	1947	29	29.50	66	42	121	9
L2TED723024R	1466	1766	2039	29	29.50	72	42	132	10
L2TED783024R	1511	1836	2130	29	29.50	78	42	143	11
L2TED843024R	1556	1906	2218	29	29.50	84	42	154	12

**L2TROL • Licence 2 Top With “O” Leg and T Base**

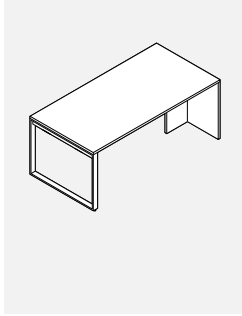

- Includes worksurface, loop leg and laminate T base.
- BG5 grommet please specify TC only.
- Loop leg is painted please specify standard paint color.

PRODUCT CODE	FINISH				W	WEIGHT		VOL FT <sup>3</sup>
	LP	B	W	D		LBS		
L2TROL2442	1128	1210	1322	24	42	138	5	
L2TROL2448	1177	1277	1380	24	48	153	5	
L2TROL2454	1230	1343	1436	24	54	168	6	
L2TROL2460	1273	1400	1494	24	60	183	6	
L2TROL2466	1291	1424	1549	24	66	198	6	
L2TROL2472	1308	1448	1609	24	72	213	7	
L2TROL2478	1340	1485	1661	24	78	228	7	
L2TROL2484	1378	1531	1716	24	84	243	7	
L2TROL3042	1322	1429	1524	30	42	168	7	
L2TROL3048	1340	1451	1539	30	48	187	7	
L2TROL3054	1372	1484	1661	30	54	206	8	
L2TROL3060	1400	1533	1729	30	60	225	8	
L2TROL3066	1415	1556	1799	30	66	243	8	
L2TROL3072	1442	1588	1866	30	72	262	9	
L2TROL3078	1472	1621	1933	30	78	281	9	
L2TROL3084	1526	1690	2003	30	84	300	10	
L2TROL3642	1451	1553	1716	36	42	200	7	
L2TROL3648	1505	1618	1801	36	48	222	8	
L2TROL3654	1556	1684	1885	36	54	245	8	
L2TROL3660	1610	1752	1972	36	60	267	9	
L2TROL3666	1663	1818	2057	36	66	290	9	
L2TROL3672	1716	1883	2142	36	72	312	10	
L2TROL3678	1767	1947	2228	36	78	335	10	
L2TROL3684	1821	2015	2312	36	84	357	11	

**L2TCROL • Licence 2 Return With “O” Leg**

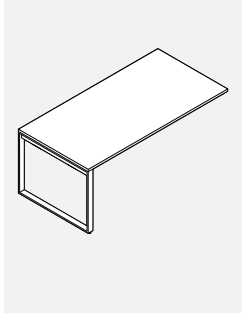

- Includes worksurface, loop leg and connecting brackets and connecting flat brackets
- HAT channel is standard on all tops except 42 and 48 wide
- BG5 grommet please specify TL,TC,TR
- Loop leg is painted please specify standard paint color
- Worksurface supporting pedestals and laterals will not fit due to the metal channel under the surface.

PRODUCT CODE	FINISH				W	WEIGHT		VOL FT <sup>3</sup>
	LP	B	W	D		LBS		
L2TCROL2442	901	988	1110	24	42	110	4	
L2TCROL2448	955	1060	1171	24	48	125	5	
L2TCROL2454	1095	1214	1315	24	54	140	5	
L2TCROL2460	1150	1288	1388	24	60	155	5	
L2TCROL2466	1181	1323	1458	24	66	170	6	
L2TCROL2472	1211	1361	1533	24	72	185	6	
L2TCROL2478	1257	1413	1599	24	78	200	6	
L2TCROL2484	1307	1473	1671	24	84	215	7	
L2TCROL3042	1076	1189	1292	30	42	137	6	
L2TCROL3048	1095	1214	1307	30	48	156	6	
L2TCROL3054	1213	1332	1521	30	54	175	7	
L2TCROL3060	1253	1396	1605	30	60	194	7	
L2TCROL3066	1279	1431	1691	30	66	212	8	
L2TCROL3072	1321	1477	1775	30	72	231	8	
L2TCROL3078	1362	1523	1857	30	78	250	8	
L2TCROL3084	1432	1609	1943	30	84	269	9	
L2TCROL3642	1214	1322	1497	36	42	164	7	
L2TCROL3648	1270	1392	1588	36	48	186	7	
L2TCROL3654	1409	1547	1763	36	54	209	8	
L2TCROL3660	1479	1629	1866	36	60	231	8	
L2TCROL3666	1548	1712	1969	36	66	254	9	
L2TCROL3672	1613	1792	2071	36	72	276	9	
L2TCROL3678	1679	1872	2173	36	78	299	10	
L2TCROL3684	1750	1955	2274	36	84	321	10	

**L2TDOL • Licence 2 Top With Two “O” Legs**

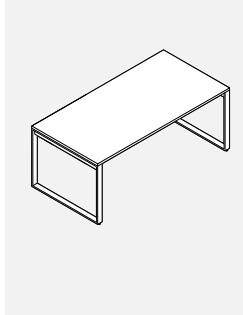

- Includes worksurface, 2 loop legs
- HAT channel is standard on all tops except 42 and 48 wide
- BG5 grommet please specify TL,TC,TR
- Loop leg is painted please specify standard paint color
- Worksurface supporting pedestals and laterals will not fit due to the metal channel under the surface.

PRODUCT CODE	FINISH					WEIGHT		VOL FT <sup>3</sup>
	LP	B	W	D	W	LBS		
L2TDOL2442	1434	1521	1642	24	42	115	6	
L2TDOL2448	1486	1593	1702	24	48	130	7	
L2TDOL2454	1628	1747	1847	24	54	145	7	
L2TDOL2460	1684	1820	1921	24	60	160	7	
L2TDOL2466	1715	1856	1991	24	66	175	8	
L2TDOL2472	1744	1894	2067	24	72	190	8	
L2TDOL2478	1788	1944	2133	24	78	205	8	
L2TDOL2484	1841	2006	2202	24	84	220	9	
L2TDOL3042	1691	1806	1907	30	42	143	9	
L2TDOL3048	1711	1830	1923	30	48	162	9	
L2TDOL3054	1828	1948	2138	30	54	181	10	
L2TDOL3060	1869	2012	2223	30	60	200	10	
L2TDOL3066	1896	2049	2308	30	66	218	11	
L2TDOL3072	1938	2094	2391	30	72	237	11	
L2TDOL3078	1979	2141	2474	30	78	256	11	
L2TDOL3084	2050	2225	2559	30	84	275	12	
L2TDOL3642	1893	2001	2176	36	42	170	10	
L2TDOL3648	1949	2071	2267	36	48	192	10	
L2TDOL3654	2089	2225	2441	36	54	215	11	
L2TDOL3660	2158	2308	2544	36	60	237	11	
L2TDOL3666	2227	2391	2648	36	66	260	12	
L2TDOL3672	2292	2471	2749	36	72	282	12	
L2TDOL3678	2358	2552	2851	36	78	305	13	
L2TDOL3684	2429	2635	2953	36	84	327	13	

**Technical Information**

All units must be connected to an adjoining unit with flat brackets included.  
 Grommet option for Runoff tables are "TC" only.  
 NOTE: All Runoff tables includes HAT CHANNEL support.

**OPTIONS:**

- Top: LP - LPL (Low Pressure Laminate) Thickness 1"  
 HP B - B Thickness 1 1/16"  
 HP W - W Thickness 1 7/16"
- Leg Option: BHML03 (DEFAULT) Round Monoleg  
 LLSQ3X3H28 - Square Leg
- Top Finish Laminate: Choose Color
- Top PVC Edging: Choose Color
- Metal Leg Finish: Choose Color

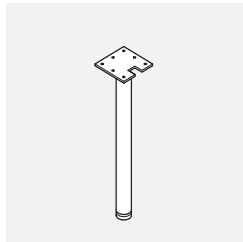

BHML03

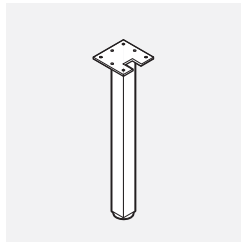

LLSQ3X3H28

**L2TCD • D-Shaped Runoff With Leg**



• Add \$103 to list price for chrome leg option.

PRODUCT CODE	FINISH			SIZE/INCHES				WEIGHT		VOL FT <sup>3</sup>
	LP	B	W	H (LP/B)	H (W)	W	D	LBS		
L2TCD3060	916	1151	1218	29	29.5	60	30	97	4	
L2TCD3066	972	1226	1310	29	29.5	66	30	106	6	
L2TCD3660	998	1272	1373	29	29.5	60	36	97	4	
L2TCD3666	1043	1343	1452	29	29.5	66	36	106	6	

**L2TCR1L • Rectangular-Shaped Runoff**

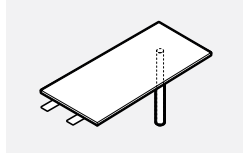

• Add \$103 to list price for chrome leg option.

PRODUCT CODE	FINISH			SIZE/INCHES				WEIGHT		VOL FT <sup>3</sup>
	LP	B	W	H (LP/B)	H (W)	W	D	LBS		
L2TCR1L3060	897	1123	1194	29	29.5	60	30	97	4	
L2TCR1L3066	937	1181	1261	29	29.5	66	30	106	6	
L2TCR1L3660	960	1225	1319	29	29.5	60	36	97	4	
L2TCR1L3666	1004	1294	1397	29	29.5	66	36	106	6	

**L2TCA1L • Axe-Shaped Runoff**

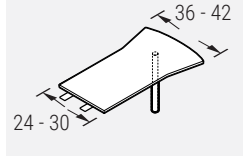

• Add \$103 to list price for chrome leg option.

PRODUCT CODE	FINISH			SIZE/INCHES				WEIGHT		VOL FT <sup>3</sup>
	LP	B	W	H (LP/B)	H (W)	W	D	LBS		
L2TCA1L2460	964	1229	1332	29	29.5	60	36	119	4	
L2TCA1L2466	1008	1297	1407	29	29.5	66	36	130	6	
L2TCA1L3060	1021	1328	1450	29	29.5	60	42	119	4	
L2TCA1L3066	1070	1403	1539	29	29.5	66	42	130	6	

**L2TCP • P-Shaped Runoff With Leg**

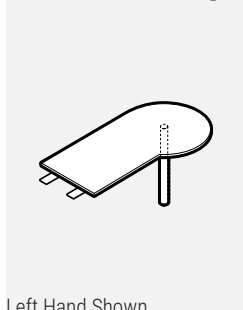

• Add \$103 to list price for chrome leg option.

PRODUCT CODE	FINISH			SIZE/INCHES				WEIGHT		VOL FT <sup>3</sup>
	LP	B	W	H (LP/B)	H (W)	W	D	LBS		
<b>Right</b>										
L2TCP3060R	995	1268	1373	29	29.5	60	36	119	4	
L2TCP3066R	1040	1342	1452	29	29.5	66	36	130	6	
L2TCP3660R	1059	1377	1504	29	29.5	60	42	119	4	
L2TCP3666R	1111	1456	1594	29	29.5	66	42	130	6	
<b>Left</b>										
L2TCP3060L	995	1268	1373	29	29.5	60	36	119	4	
L2TCP3066L	1040	1342	1452	29	29.5	66	36	130	6	
L2TCP3660L	1059	1377	1504	29	29.5	60	42	119	4	
L2TCP3666L	1111	1456	1594	29	29.5	66	42	130	6	

Left Hand Shown

**L2TCW • Wedge-Shaped Runoff With Leg**

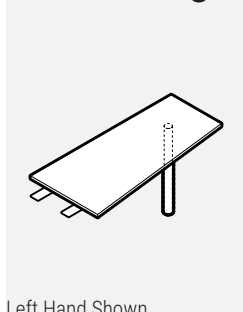

• Add \$103 to list price for chrome leg option.

PRODUCT CODE	FINISH			SIZE/INCHES				WEIGHT		VOL FT <sup>3</sup>
	LP	B	W	H (LP/B)	H (W)	W	D	LBS		
<b>Right</b>										
L2TCW3060R	941	1176	1261	29	29.5	60	30	119	4	
L2TCW3066R	982	1237	1331	29	29.5	66	30	130	6	
L2TCW3660R	1008	1284	1391	29	29.5	60	36	119	4	
L2TCW3666R	1053	1353	1470	29	29.5	66	36	130	6	
<b>Left</b>										
L2TCW3060L	941	1176	1261	29	29.5	60	30	119	4	
L2TCW3066L	982	1237	1331	29	29.5	66	30	130	6	
L2TCW3660L	1008	1284	1391	29	29.5	60	36	119	4	
L2TCW3666L	1053	1353	1470	29	29.5	66	36	130	6	

Left Hand Shown

**Floating Tops**

- Monolegs and Support channel ships in a separate box.
- Floating tops are not pre-drilled to accept monolegs or spacers.
- Grommet locations (TC only) must be specified at the time of order or it will default to "No Grommet" option.
- Floating top must be placed on top of 1H credenza or 1H lateral open.
- Grommet Option TC only
- All Floating tables include HAT CHANNEL support.

**L2SQ3X3 • "Spacer" Leg**

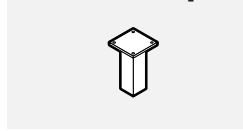

PRODUCT CODE	PRICE	CHROME OPT	SIZE/INCHES			WEIGHT LBS	VOL FT <sup>3</sup>
			H	W	D		
L2SQ3X3	183	285	8	3	3	4	0.09

**L2SQ3X3H28 • Square Leg**

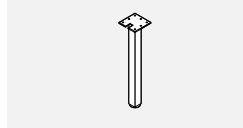

PRODUCT CODE	PRICE	CHROME OPT	SIZE/INCHES			WEIGHT LBS	VOL FT <sup>3</sup>
			H	W	D		
L2SQ3X3H28	328	428	28	3	3	4	0.17

**L2FD • Floating D-Shaped With Legs and Spacers**

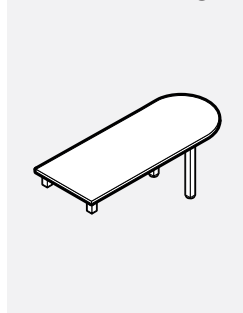

- Add \$415 to list price for chrome leg option.

PRODUCT CODE	FINISH			SIZE/INCHES				WEIGHT LBS	VOL FT <sup>3</sup>
	LP	B	W	H(LP/B)	H(W)	W	D		
L2FD3060	1208	1452	1478	29	29.5	60	30	53	7
L2FD3066	1248	1515	1545	29	29.5	66	30	57	7
L2FD3072	1289	1575	1610	29	29.5	72	30	62	8
L2FD3078	1334	1645	1677	29	29.5	78	30	64	8
L2FD3084	1388	1721	1740	29	29.5	84	30	68	9
L2FD3660	1267	1588	1705	29	29.5	60	36	57	8
L2FD3666	1312	1659	1788	29	29.5	66	36	63	8
L2FD3672	1356	1732	1868	29	29.5	72	36	68	9
L2FD3678	1408	1812	1952	29	29.5	78	36	70	9
L2FD3684	1470	1899	2035	29	29.5	84	36	75	10

**L2FR • Floating Rectangular-Shaped With Legs and Spacers**

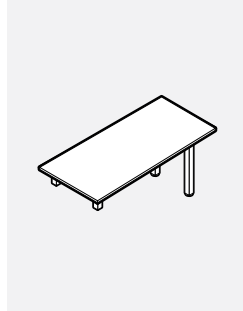

- Add \$415 to list price for chrome leg option.

PRODUCT CODE	FINISH			SIZE/INCHES				WEIGHT LBS	VOL FT <sup>3</sup>
	LP	B	W	H(LP/B)	H(W)	W	D		
L2FR2460	1142	1346	1383	29	29.5	60	24	51	6
L2FR2466	1177	1399	1437	29	29.5	66	24	55	6
L2FR2472	1215	1452	1494	29	29.5	72	24	59	7
L2FR2478	1256	1511	1550	29	29.5	78	24	62	7
L2FR2484	1304	1577	1607	29	29.5	84	24	66	8
L2FR3060	1203	1448	1507	29	29.5	60	30	53	7
L2FR3066	1245	1511	1572	29	29.5	66	30	57	7
L2FR3072	1286	1572	1642	29	29.5	72	30	62	8
L2FR3078	1332	1641	1707	29	29.5	78	30	64	8
L2FR3084	1385	1716	1774	29	29.5	84	30	68	9
L2FR3660	1226	1505	1617	29	29.5	60	36	57	8
L2FR3666	1270	1572	1694	29	29.5	66	36	63	8
L2FR3672	1315	1645	1772	29	29.5	72	36	68	9
L2FR3678	1364	1717	1851	29	29.5	78	36	70	9
L2FR3684	1424	1802	1930	29	29.5	84	36	75	10

**L2FA • Floating Axe-Shaped With Legs and Spacers**

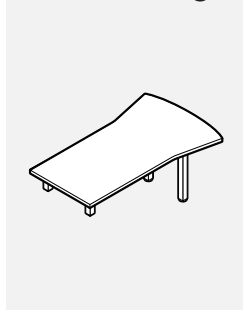

- Add \$415 to list price for chrome leg option.

PRODUCT CODE	FINISH			SIZE/INCHES				WEIGHT LBS	VOL FT <sup>3</sup>
	LP	B	W	H(LP/B)	H(W)	W	D		
L2FA3060	1334	1661	1770	29	29.5	60	42	77	8
L2FA3066	1385	1743	1860	29	29.5	66	42	81	8
L2FA3072	1436	1823	1950	29	29.5	72	42	84	9
L2FA3078	1491	1909	2039	29	29.5	78	42	88	9
L2FA3084	1558	2006	2130	29	29.5	84	42	95	10
L2FA3660	1421	1790	1936	29	29.5	60	48	83	9
L2FA3666	1475	1880	2038	29	29.5	66	48	88	9
L2FA3672	1533	1971	2138	29	29.5	72	48	90	10
L2FA3678	1594	2067	2239	29	29.5	78	48	95	11
L2FA3684	1666	2171	2341	29	29.5	84	48	101	11

**L2FP • Floating P-Shaped With Legs and Spacers**

• Add \$415 to list price for chrome leg option.

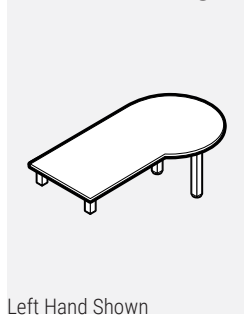

Left Hand Shown

PRODUCT CODE	FINISH LP	B	W	SIZE/INCHES			WEIGHT LBS	VOL FT <sup>3</sup>	
				H(LP/B)	H(W)	D			
<b>Right</b>									
L2FP3060R	1290	1577	1673	29	29.5	60	36	66	8
L2FP3066R	1335	1650	1752	29	29.5	66	36	70	8
L2FP3072R	1383	1721	1829	29	29.5	72	36	75	9
L2FP3078R	1432	1798	1906	29	29.5	78	36	77	9
L2FP3084R	1491	1884	1985	29	29.5	84	36	81	10
L2FP3660R	1353	1684	1803	29	29.5	60	42	70	9
L2FP3666R	1403	1765	1890	29	29.5	66	42	76	9
L2FP3672R	1456	1846	1981	29	29.5	72	42	81	10
L2FP3678R	1512	1930	2071	29	29.5	78	42	84	11
L2FP3684R	1577	2025	2163	29	29.5	84	42	88	11
<b>Left</b>									
L2FP3060L	1290	1577	1673	29	29.5	60	36	66	8
L2FP3066L	1335	1650	1752	29	29.5	66	36	70	8
L2FP3072L	1383	1721	1829	29	29.5	72	36	75	9
L2FP3078L	1432	1798	1906	29	29.5	78	36	77	9
L2FP3084L	1491	1884	1985	29	29.5	84	36	81	10
L2FP3660L	1353	1684	1803	29	29.5	60	42	70	9
L2FP3666L	1403	1765	1890	29	29.5	66	42	76	9
L2FP3672L	1456	1846	1981	29	29.5	72	42	81	10
L2FP3678L	1512	1930	2071	29	29.5	78	42	84	11
L2FP3684L	1577	2025	2163	29	29.5	84	42	88	11

**L2FW • Floating Wedge-Shaped With Legs and Spacers**

• Add \$415 to list price for chrome leg option.

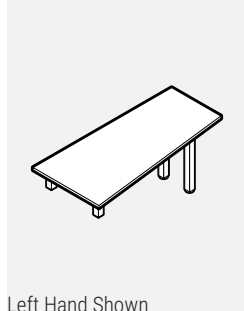

Left Hand Shown

PRODUCT CODE	FINISH LP	B	W	SIZE/INCHES			WEIGHT LBS	VOL FT <sup>3</sup>	
				H(LP/B)	H(W)	D			
<b>Right</b>									
L2FW3060R	1290	1534	1594	29	29.5	60	30	53	7
L2FW3066R	1337	1604	1716	29	29.5	66	30	57	7
L2FW3072R	1382	1668	1740	29	29.5	72	30	62	8
L2FW3078R	1432	1743	1814	29	29.5	78	30	64	8
L2FW3084R	1493	1824	1885	29	29.5	84	30	68	9
L2FW3660R	1351	1640	1721	29	29.5	60	36	57	8
L2FW3666R	1403	1717	1808	29	29.5	66	36	63	8
L2FW3672R	1457	1794	1887	29	29.5	72	36	68	9
L2FW3678R	1511	1872	1971	29	29.5	78	36	70	9
L2FW3684R	1577	1965	2078	29	29.5	84	36	75	10
<b>Left</b>									
L2FW3060L	1290	1534	1594	29	29.5	60	30	53	7
L2FW3066L	1337	1604	1716	29	29.5	66	30	57	7
L2FW3072L	1382	1668	1740	29	29.5	72	30	62	8
L2FW3078L	1432	1743	1814	29	29.5	78	30	64	8
L2FW3084L	1493	1824	1885	29	29.5	84	30	68	9
L2FW3660L	1351	1640	1721	29	29.5	60	36	57	8
L2FW3666L	1403	1717	1808	29	29.5	66	36	63	8
L2FW3672L	1457	1794	1887	29	29.5	72	36	68	9
L2FW3678L	1511	1872	1971	29	29.5	78	36	70	9
L2FW3684L	1577	1965	2078	29	29.5	84	36	75	10

**L2FBR • Floating Top Rectangular With Legs (Spacers Sold Separately)**

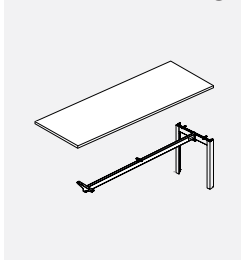

- Anodized aluminum leg upcharge \$44.
- Due to beam location, grommet is only available as a special request, please contact your customer service representative.
- Worksurface supporting pedestals and laterals will not fit due to the metal channel under the surface.

PRODUCT CODE	FINISH LP	B	W	SIZE / INCHES			D	WEIGHT LBS	VOL FT <sup>3</sup>
				H (LP/B)	H (W)	W			
L2FBR2466	1080	1238	1371	1	1.44	66	24	51	6
L2FBR2472	1112	1286	1426	1	1.44	72	24	55	6
L2FBR2478	1156	1344	1494	1	1.44	78	24	59	7
L2FBR2484	1207	1407	1569	1	1.44	84	24	62	7
L2FBR3066	1167	1365	1518	1	1.44	66	30	53	8
L2FBR3072	1205	1421	1588	1	1.44	72	30	57	8
L2FBR3078	1252	1488	1666	1	1.44	78	30	62	9
L2FBR3084	1308	1560	1752	1	1.44	84	30	64	9

**L2SPBOX • Laminate Spacers With Glass Shelf**

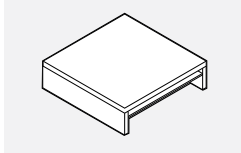

- Glazing is clear.

PRODUCT CODE	PRICE LP	SIZE / INCHES			WEIGHT LBS	VOL FT <sup>3</sup>
		H	W	D		
L2SPBOX1620	709	8	16	20	15	1
L2SPBOX1626	795	8	16	26	18	2
L2SPBOX1634	901	8	16	34	22	5

**L2FFL • Licence Floating Tops With "O" Leg**

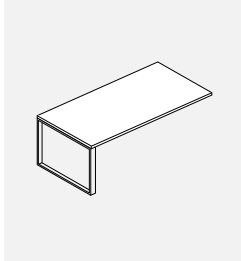

- Kit includes a worksurface, "O" leg and channel.
- Option for grommet - BG5, TC only.
- Painted loop leg, please specify standard paint color.
- Worksurface supporting pedestals and laterals will not fit due to the metal channel under the surface.

PRODUCT CODE	FINISH LP	B	W	SIZE / INCHES			D	WEIGHT LBS	VOL FT <sup>3</sup>
				H (LP/B)	H (W)	W			
L2FFL2466	1096	1238	1373	1	1.44	66	24	55	6
L2FFL2472	1123	1273	1445	1	1.44	72	24	59	7
L2FFL2478	1165	1319	1502	1	1.44	78	24	62	7
L2FFL2484	1214	1380	1574	1	1.44	84	24	66	8
L2FFL3066	1194	1346	1607	1	1.44	66	30	57	7
L2FFL3072	1232	1388	1686	1	1.44	72	30	62	8
L2FFL3078	1270	1432	1766	1	1.44	78	30	64	8
L2FFL3084	1339	1516	1850	1	1.44	84	30	68	9
L2FFL3666	1463	1628	1884	1	1.44	66	36	63	8
L2FFL3672	1524	1702	1980	1	1.44	72	36	68	9
L2FFL3678	1588	1781	2080	1	1.44	78	36	70	9
L2FFL3684	1656	1862	2181	1	1.44	84	36	75	10

**L2HGAMP • Hanging Aluminum-Framed Frosted Glazing Modesty**

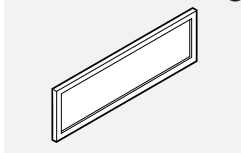

- Framed is anodize aluminum.
- Glazing is frosted acrylic.
- Hanging brackets are included.

PRODUCT CODE	PRICE	SIZE / INCHES			WEIGHT LBS	VOL FT <sup>3</sup>
		H	W	D		
L2HGAMP36	637	14	35.50	0.75	12	1
L2HGAMP42	685	14	41.50	0.75	13	1
L2HGAMP48	733	14	47.50	0.75	14	1
L2HGAMP54	782	14	53.50	0.75	16	1

**L2HGMP • Hanging Laminate Modesty**

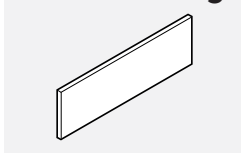

- Hanging brackets are included.

PRODUCT CODE	PRICE LP	SIZE / INCHES			WEIGHT LBS	VOL FT <sup>3</sup>
		H	W	D		
L2HGMP36	285	14	36	0.75	9	1
L2HGMP42	296	14	42	0.75	11	1
L2HGMP48	303	14	48	0.75	13	1
L2HGMP54	311	14	54	0.75	14	1

## GENERAL NOTES

**Pedestals****• Pedestals are shipped assembled.**

- Pedestals are offered in three types of applications: Worksurface-Supporting, Freestanding, and Mobile.
- Pedestal front width is 15-1/2" with a deep size variation 18" 23" 24" 29" 30" 36"
- If specifying a pedestal for a desk or credenza, please ensure you specify next depth lower ie. 23" deep pedestal for a 24" deep credenza or desk.
- Worksurface supporting Pedestals are 28"high
- Freestanding pedestals come with the choice of "LP", "B" for 29"high or "W" thickness top for 29.5"high
- Pedestals Freestanding are on adjustable levelers
- Mobile pedestals come with a top with the choice of "LP", "B" for 29"high or "W" thickness top for 29.5"high and have front locking casters to support the pedestal.
- Pencil tray included in the top box drawer of each pedestal.
- Box drawers mounted on full extension ball bearing slides
- File drawers mounted on full extension ball bearing slides
- All file drawers come with adjustable rails for legal or letter size hanging folders. See File Drawer Capacity chart page G2.
- Pull out shelf for CPU and printer units can support 75 lbs. per shelf and has telescopic extension.
- CPU and printer units have ventilation grommet on back panel.
- Interior clearance of printer shelf is 11".
- Printer pedestals have 2 pull out shelves and the back panel has four round grommets.
- CPU pedestals have 1 pull out shelf and the back panel has two round grommets.
- Both CPU and printer units must be installed under a worksurface to prevent tipping.
- All pedestals with a door, include 1 adjustable shelf.
- Cases and fronts are finished in low pressure laminate.
- Specify thickness of the top to match the thickness of the worksurface.
- Locks are standard on all units. Available in black or silver finish. The lock will match the handle finish.

**Hutches and Overheads****• Hutches and overheads are shipped assembled.**

- Hutches and overheads are offered in "LP" and "W" thickness with three option heights. See Storage Technical Info page G3.
- Specify thickness of hutch or overhead top to match the thickness of the worksurface.
- Cases and fronts are finished in low pressure laminate.
- Hutches and overheads with hinged doors (laminate or aluminum), flip up fronts have no handle option.
- Hutches with pigeon holes come with touch latch mechanism.
- Hutches and overheads with sliding laminate doors have standard handle options
- Hutches and overheads with sliding glass doors are offered with recessed handle only. The recessed handle is in chrome finish.
- Hutches and wall mounted overheads are offered in 4 styles: Open storage, Hinged doors - laminate or anodized aluminum frame doors with the option for glazing: frosted or clear, sliding doors are laminate or glass doors and flip-up doors.
- Once installed, the bottom of the flip-up door overhead will not line up with the bottom of the open or hinged door overhead.
- Wall mounted storage cabinets must be securely attached to wall studs.
- Panel-mounted overheads include attachment brackets for Boulevard panels.
- Back panels on hutches comes with a center round grommet for wire access.
- Top on hutch and overhead storage cabinets with flip-up doors is 3/4" thick Low Pressure Laminate. Doors slides on top of the unit.
- Inside dimension for hutches and wall mounted units with flip-up doors is 13 1/4" high x 14 1/2" deep.
- Inside dimension for hutches and wall mounted with hinged doors is 12 3/4" high x 15 1/4" deep.
- Inside dimension for open hutches and wall mounted is 12 3/4" high x 15 1/4" deep.
- Inside dimension for hutches and wall mounted with sliding doors is 12-3/4"high x 13" deep.
- Use double-sided tape to attach hutches to worksurface.
- Locks are standard on all units. Available in black or silver finish. The lock will match the handle finish.
- Recommended to be installed against and fixed to a wall using appropriate hardware (not included).

**Credenzas****• Credenzas are shipped assembled.**

- Credenza model # L2CR2H2H or L2CR1H1H must be ordered with counterweights to avoid tipping.
- Credenza come with the choice of "LP", "B" or "W" thickness top.
- Credenzas are offered with the choice of "LP", "B" for 20"h. or 29"high and "W" thickness top for 20.5"h or 29.5"high.
- Credenza come with hinged doors, laminate or anodized aluminum frame doors with the option for glazing: frosted or clear.
- Locks are standard on all units. Available in black or silver finish. The lock will match the handle finish.

**Bookcases****• Bookcases are Shipped knocked down (KD).**

- Available in 30" or 36" widths and 12.685" and 16.685"depths dimension at baseboard with range in height from 29" to 72" with 12" clearance between shelves.
- Bottom shelf is fixed and all other shelves are adjustable.
- Specify thickness of the top to match the thickness and profile of the worksurface.
- Tops are offered "LP" or "B" or "W".
- Up to 42"h, Bookcases are offered in "LP", "B", "W".
- 54"h. and up are offered in "LP" and "W".
- Recommended to be installed against and fixed to a wall using appropriate hardware (not included).

**Laterals****• Laterals are shipped assembled.**

- Laterals are available in three widths, 30" 36", 42" with a height variation of 28" to 54" and a depth of 20" and 24".
- Tops are offered LP, B or W.
- Worksurface supporting units do not come with a top.
- Up to 42"h, laterals are offered in "LP", "B", "W".
- 54"h and Up are offered in "LP" and "W".
- Cases and fronts are finished in low pressure laminate.
- Laterals with hinged doors, laminate or anodized aluminum frame doors with the option for glazing: frosted or clear.
- Lateral files are offered in 2 types of applications: Worksurface-Supporting and Freestanding.
- All lateral files feature a drawer interlocking mechanism.
- Up to 42"h, Laterals are offered in "LP", "B", "W".
- 54"h, and up are offered in "LP" and "W".
- All file drawer come with adjustable rails for legal or letter size hanging folders.
- Counterweights must be specified in a lateral configurations except worksurface-supporting.
- "C" combo lateral have a pencil drawer included in the box drawer. The pencil tray is parallel with the depth of the drawer.
- In "C" combo lateral, only one side can be locked.
- All laterals with a door, include 1 adjustable shelf.
- File drawers mounted on full extension ball bearing slides.
- Locks are standard on all units. Available in black or silver finish. The lock will match the handle finish.

**Towers and cabinets****• Towers and cabinets are shipped assembled.**

- Towers offered 24"w and cabinets 30"w and 36"w are offered in "LP" and "W".
- Cases are finished in low pressure laminate.
- Towers or cabinets are offered with hinged doors, laminate or anodized aluminum frame with the option for glazing: frosted or clear.
- Towers or cabinets with anodized aluminum doors are offered without handles. Touch latch mechanism is included.
- Storage tower with the cupboard above FF or BBF and wardrobe will lock only the wardrobe and drawers.
- Storage tower with the wardrobe include a coat rod.
- Locks are standard on all units. Available in black or silver finish. The lock will match the handle finish.
- Counterweights must be specified for units 20" deep by 60" to 72" high with 2H2D or 2H/Open, please order 2 x LACWB for each unit.



## LATERAL FILE DRAWERS

**Lateral File Drawer:**

36W &amp; 42W

Legal Filing - front to back

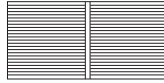

Drawer file with plastic rail

30"W Size 9.44"H x 25.75"W x 16"L

36"W Size 9.44"H x 31.75"W x 16"L

42"W Size 9.44"H x 37.75"W x 16"L

**Lateral File Drawer:**

36W &amp; 42W

Legal Filing - side to side

Letter Filing - front to back

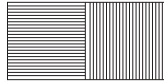
**Lateral File Drawer:**

30W, 36W &amp; 42W

Letter Filing - front to back

**Lateral File Drawer:**

36W &amp; 42W

Letter &amp; Legal Filing - front to back

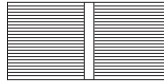
**Lateral File Drawer:**

30W, 36W &amp; 42W

Legal Filing - side to side

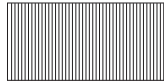

## PEDESTAL DRAWERS

**Box Drawer:**

15.5W

Legal Filing - side to side



18"D Drawer Box Size 3.93"H x 13"W x 16"L

20.23.24.29.30.36"D Drawer Box Size 3.93"H x 13"W x 20"L

**File Drawer:**

15.5W

Letter Filing - front to back



18"D Drawer File with plastic rail Size 9.4"H x 13"W x 16"L

20"D and up Drawer File with plastic rail Size 9.4"H x 13"W x 20"L

**File Drawer:**

15.5W

Legal Filing - side to side



18"D Drawer File with plastic rail Size 9.4"H x 13"W x 16"L

20"D and up Drawer File with plastic rail Size 9.4"H x 13"W x 20"L

## COMBO LATERAL FILE DRAWERS

For 30" wide units: Drawer width is 11 3/4" and can accommodate only side to side legal or letter filing.

For 36" wide units: Drawer width is 14 3/4" and can accommodate only side to side legal or letter filing.

**STORAGE TECHNICAL INFORMATION**

**1" LPL TOP  
LP HUTCH  
LP DESK 29H  
LP CABINET**

**1-1/16" HPL TOP  
LP HUTCH  
B TOP DESK 29H  
LP CABINET**

**1-7/16" HPL TOP  
W TOP HUTCH  
W TOP DESK 29.5H  
W CABINET**

**NO TACKBOARD  
LTB  
50"High**

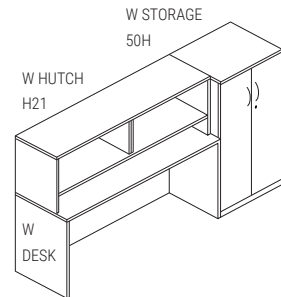
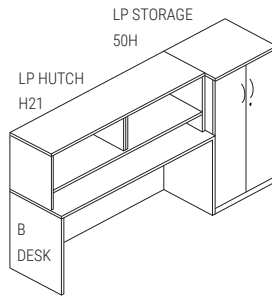
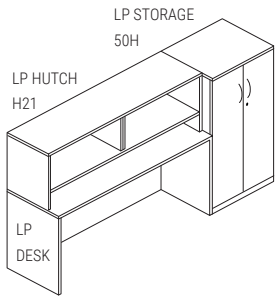

**TACKBOARD  
LTB21  
66" High**

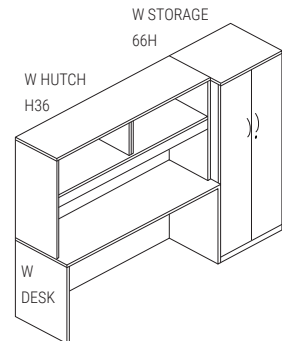
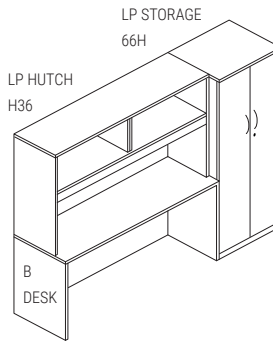
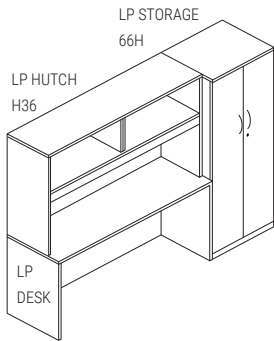

**TACKBOARD  
LTB27  
72" High**

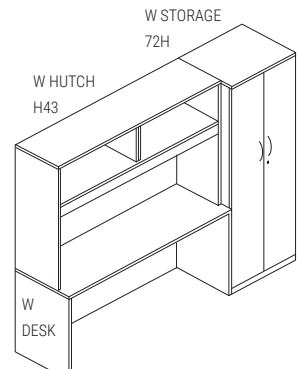
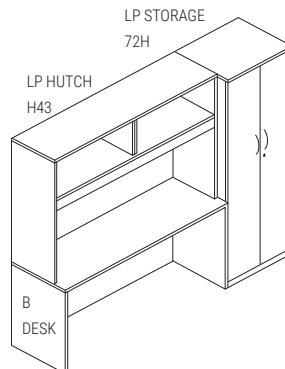
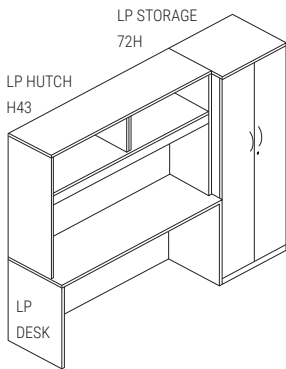

**STACK-ON TWO-HEIGHT CABINET IS TO BE PLACED ON 1-HIGH CREDENZA**

**50" High  
Only**

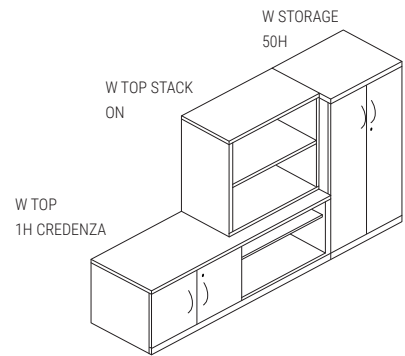
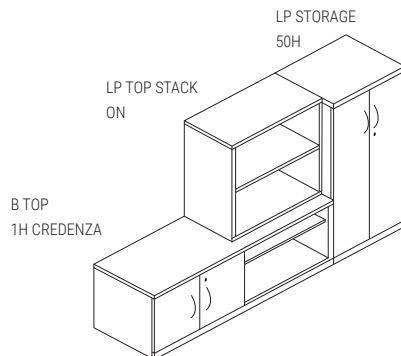
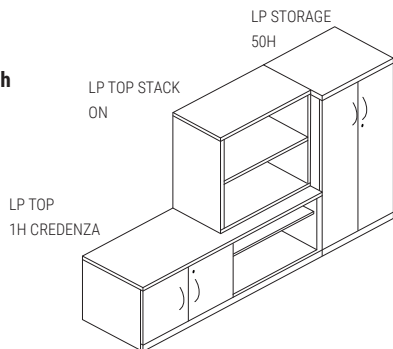

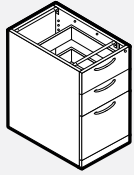
**L2PBBF • Worksurface-Supporting Box/Box/File Pedestal**

- One lock included.
- Optional e-lock available in the vertical position. Please specify V - Vertical and add \$304 list.
- Counter weight must be ordered separately.

PRODUCT CODE	PRICE	SIZE/INCHES			WEIGHT LBS	VOL FT <sup>3</sup>
		H	W	D		
L2PBBF18	1056	28	15.5	18	94	8
L2PBBF20	1151	28	15.5	20	94	8
L2PBBF23	1169	28	15.5	23	94	8
L2PBBF24	1169	28	15.5	24	99	10
L2PBBF29	1211	28	15.5	29	105	10
L2PBBF30	1211	28	15.5	30	110	10
L2PBBF36	1270	28	15.5	36	116	11

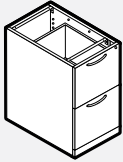
**L2PFF • Worksurface-Supporting File/File Pedestal**

- One lock included.
- Optional e-lock available in the vertical position. Please specify V - Vertical and add \$304 list.

PRODUCT CODE	PRICE	SIZE/INCHES			WEIGHT LBS	VOL FT <sup>3</sup>
		H	W	D		
L2PFF18	960	28	15.5	18	94	8
L2PFF20	1073	28	15.5	20	94	8
L2PFF23	1089	28	15.5	23	94	8
L2PFF24	1089	28	15.5	24	99	8
L2PFF29	1143	28	15.5	29	105	10
L2PFF30	1143	28	15.5	30	110	10
L2PFF36	1188	28	15.5	36	116	11

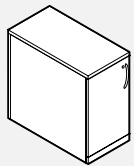
**L2P1D • Worksurface-Supporting 1-Door Pedestal**

- Includes one adjustable shelf.
- One lock included.
- Optional e-lock available in the horizontal position. Please specify HL - Horizontal Left and add \$304 list.

PRODUCT CODE	PRICE	SIZE/INCHES			WEIGHT LBS	VOL FT <sup>3</sup>
		H	W	D		
L2P1D18	806	28	15.5	18	66	8
L2P1D20	869	28	15.5	20	74	8
L2P1D23	891	28	15.5	23	74	8
L2P1D24	891	28	15.5	24	75	10
L2P1D29	977	28	15.5	29	84	10
L2P1D30	977	28	15.5	30	85	10

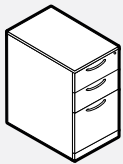
**L2PBBF-F • Freestanding Box/Box/File Pedestal**

- One lock included.
- Optional e-lock available in the vertical position. Please specify V - Vertical and add \$304 list.
- Counter weight must be ordered separately.

PRODUCT CODE	FINISH LP	B	W	SIZE/INCHES				WEIGHT LBS	VOL FT <sup>3</sup>
				H (LP/B)	H (W)	W	D		
L2PBBF20F	1251	1286	1335	29	29.5	15.5	20	94	8
L2PBBF24F	1267	1304	1353	29	29.5	15.5	24	99	8
L2PBBF30F	1319	1364	1421	29	29.5	15.5	30	105	10
L2PBBF36F	1385	1437	1501	29	29.5	15.5	36	116	11

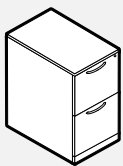
**L2PFF-F • Freestanding File/File Pedestal**

- One lock included.
- Optional e-lock available in the vertical position. Please specify V - Vertical and add \$304 list.
- Counter weight must be ordered separately.

PRODUCT CODE	FINISH LP	B	W	SIZE/INCHES				WEIGHT LBS	VOL FT <sup>3</sup>
				H (LP/B)	H (W)	W	D		
L2PFF20F	1132	1169	1251	29	29.5	15.5	20	99	8
L2PFF24F	1148	1183	1268	29	29.5	15.5	24	99	8
L2PFF30F	1245	1289	1342	29	29.5	15.5	30	110	10
L2PFF36F	1350	1404	1425	29	29.5	15.5	36	116	11

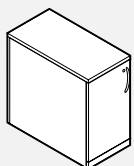
**L2P1D-F • Freestanding 1-Door Pedestal**

- Includes one adjustable shelf.
- One lock included.
- Optional e-lock available in the horizontal position. Please specify HL - Horizontal Left and add \$304 list.
- Counter weight must be ordered separately.

PRODUCT CODE	FINISH LP	B	W	SIZE/INCHES				WEIGHT LBS	VOL FT <sup>3</sup>
				H (LP/B)	H (W)	W	D		
L2P1D20F	965	1031	1078	29	29.5	15.5	20	78	8
L2P1D24F	981	1048	1092	29	29.5	15.5	24	98	8
L2P1D30F	1078	1161	1215	29	29.5	15.5	30	103	10
L2P1D36F	1181	1279	1343	29	29.5	15.5	36	110	11

**L2PBFF-MIT • Mobile Box/Box/File Pedestal to fit Under Worksurface**



- One lock included.
- Optional e-lock available in the vertical position. Please specify V - Vertical and add \$304 list.
- Counter weight must be ordered separately.
- 18" deep mobile pedestal has a fifth caster at center bottom.

PRODUCT CODE	PRICE	SIZE/INCHES			WEIGHT LBS	VOL FT <sup>3</sup>
		H	W	D		
L2PBFF18MIT	1522	28	15.5	18	99	8
L2PBFF23MIT	1610	28	15.5	23	105	8
L2PBFF29MIT	1690	28	15.5	29	110	10

**L2PBFF-M • Mobile Box/Box/File Pedestal With Standard Top**



- One lock included.
- Optional e-lock available in the vertical position. Please specify V - Vertical and add \$304 list.
- Counter weight must be ordered separately.
- 20" deep mobile pedestal has a fifth caster at center bottom.

PRODUCT CODE	FINISH LP	B	W	SIZE/INCHES				WEIGHT LBS	VOL FT <sup>3</sup>
				H (LP/B)	H (W)	W	D		
L2PBFF20M	1642	1652	1728	29	29.5	15.5	20	99	8
L2PBFF24M	1668	1679	1755	29	29.5	15.5	24	99	8
L2PBFF30M	1702	1743	1799	29	29.5	15.5	30	105	10
L2PBFF36M	1772	1819	1872	29	29.5	15.5	36	110	11

**L2PFF-MIT • Mobile File/File Pedestal to fit Under Worksurface**

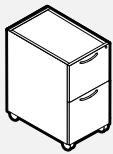

- One lock included.
- Optional e-lock available in the vertical position. Please specify V - Vertical and add \$304 list.
- Counter weight must be ordered separately.
- 18" deep mobile pedestal has a fifth caster at center bottom.

PRODUCT CODE	PRICE	SIZE/INCHES			WEIGHT LBS	VOL FT <sup>3</sup>
		H	W	D		
L2PFF18MIT	1300	28	15.5	18	99	8
L2PFF23MIT	1383	28	15.5	23	105	8
L2PFF29MIT	1452	28	15.5	29	110	10

**L2PFF-M • Mobile File/File Pedestal With Standard Top**

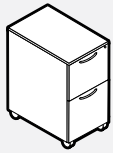

- One lock included.
- Optional e-lock available in the vertical position. Please specify V - Vertical and add \$304 list.
- Counter weight must be ordered separately.
- 20" deep mobile pedestal has a fifth caster at center bottom.

PRODUCT CODE	FINISH LP	B	W	SIZE/INCHES				WEIGHT LBS	VOL FT <sup>3</sup>
				H (LP/B)	H (W)	W	D		
L2PFF20M	1391	1425	1467	29	29.5	15.5	20	99	8
L2PFF24M	1413	1446	1490	29	29.5	15.5	24	99	8
L2PFF30M	1463	1504	1582	29	29.5	15.5	30	105	10
L2PFF36M	1537	1587	1642	29	29.5	15.5	36	110	11

**L2PBF-M • Mobile Box/File Pedestal With Standard Top**



- One lock included.
- Optional e-lock available in the vertical position. Please specify V - Vertical and add \$304 list.
- Counter weight must be ordered separately.
- 20" deep mobile pedestal has a fifth caster at center bottom.

PRODUCT CODE	FINISH LP	B	W	SIZE/INCHES				WEIGHT LBS	VOL FT <sup>3</sup>
				H (LP/B)	H (W)	W	D		
L2PBF20M	1214	1251	1317	22.69	23.15	15.5	20	78	7
L2PBF24M	1229	1267	1335	22.69	23.15	15.5	24	80	7
L2PBF30M	1270	1316	1369	22.69	23.15	15.5	30	90	9

**L2PBF-MIT • Mobile Box/File Pedestal With Inset Top**



- One lock included.
- Optional e-lock available in the vertical position. Please specify V - Vertical and add \$304 list.
- Counter weight must be ordered separately.
- 18" deep mobile pedestal has a fifth caster at center bottom.

PRODUCT CODE	PRICE	SIZE/INCHES			WEIGHT LBS	VOL FT <sup>3</sup>
		H	W	D		
L2PBF18MIT	1135	22	15.5	18	99	8
L2PBF23MIT	1208	22	15.5	23	99	8
L2PBF24MIT	1208	22	15.5	24	105	8
L2PBF29MIT	1275	22	15.5	29	105	8
L2PBF30MIT	1275	22	15.5	30	110	10

**L2PU • Printer Unit With 2 Pull-Out Shelves**

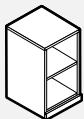

PRODUCT CODE	PRICE	SIZE/INCHES			WEIGHT LBS	VOL FT <sup>3</sup>
		H (LP/B)	W	D		
L2PU18	1164	28	22	18	83	8
L2PU22	1264	28	22	22	88	9
L2PU24	1319	28	22	24	94	10

**L2L2H • Worksurface-Supporting File/File Lateral for 18" Deep and 22" Deep Units**

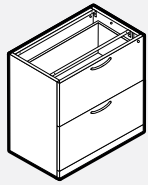

- One lock included.
- Optional e-lock available in the vertical position. Please specify V - Vertical and add \$304 list.

PRODUCT CODE	PRICE	SIZE / INCHES			WEIGHT LBS	VOL FT <sup>3</sup>
		H (LP/B)	W	D		
L2L2H1830	1550	28	30	18	189	12
L2L2H1836	1648	28	36	18	209	14
L2L2H1842	1713	28	42	18	216	20
L2L2H2230	1592	28	30	22	189	12
L2L2H2236	1695	28	36	22	209	14
L2L2H2242	1814	28	42	22	216	20

**L2L2D • Worksurface-Supporting 2-Door Storage Lateral With 1 Adjustable Shelf**

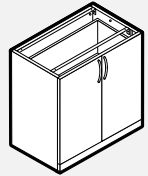

- One lock included.
- Optional e-lock available in the horizontal position. Please specify HR - Horizontal Right and add \$304 list.

PRODUCT CODE	PRICE	SIZE / INCHES			WEIGHT LBS	VOL FT <sup>3</sup>
		H (LP/B)	W	D		
L2L2D1830	1081	28	30	18	171	12
L2L2D1836	1139	28	36	18	178	14
L2L2D1842	1252	28	42	18	180	20
L2L2D2230	1170	28	30	22	171	12
L2L2D2236	1203	28	36	22	178	14
L2L2D2242	1385	28	42	22	180	20

**L2L2AD • Worksurface-Supporting 2-Aluminum-Door Storage Lateral With 1 Adjustable Shelf**

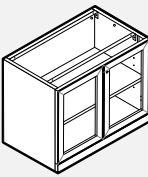

- One lock included.
- E-lock not available for aluminum-framed glass doors.

PRODUCT CODE	PRICE	SIZE / INCHES			WEIGHT LBS	VOL FT <sup>3</sup>
		H (LP/B)	W	D		
L2L2AD1830	1866	28	30	18	165	12
L2L2AD1836	1999	28	36	18	172	14
L2L2AD1842	2185	28	42	18	174	20
L2L2AD2230	1954	28	30	22	165	12
L2L2AD2236	2063	28	36	22	172	14
L2L2AD2242	2317	28	42	22	174	20

**L2LCR • Worksurface-Supporting Lateral File Combo**

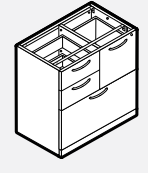

- One lock included.
- Optional e-lock available in the vertical position. Please specify V - Vertical and add \$304 list.

PRODUCT CODE	PRICE	SIZE / INCHES			WEIGHT LBS	VOL FT <sup>3</sup>
		H (LP/B)	W	D		
L2LCR1830	1899	28	30	18	204	12
L2LCR1836	2218	28	36	18	215	14
L2LCR2230	2208	28	30	22	204	12
L2LCR2236	2320	28	36	22	215	14

**L2LCL • Worksurface-Supporting Lateral File Combo**

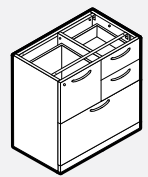

- One lock included.
- E-lock not available.

PRODUCT CODE	PRICE	SIZE / INCHES			WEIGHT LBS	VOL FT <sup>3</sup>
		H (LP/B)	W	D		
L2LCL1830	1899	28	30	18	204	12
L2LCL1836	2218	28	36	18	215	14
L2LCL2230	2208	28	30	22	204	12
L2LCL2236	2320	28	36	22	215	14

**L2LCR • Lateral File Combo With Top**

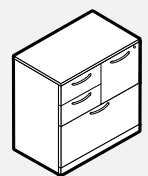

- One lock included.
- Optional e-lock available in the vertical position. Please specify V - Vertical and add \$304 list.

PRODUCT CODE	FINISH LP	B	W	SIZE / INCHES			WEIGHT LBS	VOL FT <sup>3</sup>	
				H (LP/B)	H (W)	D			
L2LCR2030	2346	2400	2461	29	29.5	30	20	204	12
L2LCR2036	2460	2493	2618	29	29.5	36	20	215	14
L2LCR2430	2440	2494	2562	29	29.5	30	24	204	12
L2LCR2436	2558	2595	2726	29	29.5	36	24	215	14

**L2LCL • Lateral File Combo With Top**

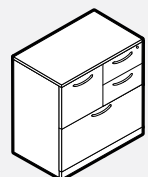

- One lock included.
- E-lock not available.

PRODUCT CODE	FINISH LP	B	W	SIZE / INCHES			WEIGHT LBS	VOL FT <sup>3</sup>	
				H (LP/B)	H (W)	D			
L2LCL2030	2346	2400	2461	29	29.5	30	20	204	12
L2LCL2036	2460	2493	2618	29	29.5	36	20	215	14
L2LCL2430	2440	2494	2562	29	29.5	30	24	204	12
L2LCL2436	2558	2595	2726	29	29.5	36	24	215	14

**L2LO • Freestanding 1-High Open Unit**

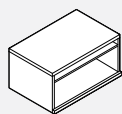

PRODUCT CODE	FINISH			SIZE/INCHES				WEIGHT LBS	VOL FT <sup>3</sup>
	LP	B	W	H(LP/B)	H(W)	W	D		
L2LO2030	837	952	1031	19.94	20.4	30	20	75	11
L2LO2036	994	1130	1176	19.94	20.4	36	20	86	13
L2LO2430	870	989	1036	19.94	20.4	30	24	75	11
L2LO2436	1035	1176	1223	19.94	20.4	36	24	86	13

**L2L2D-H20 • Freestanding 2 Doors, 1-High Unit**

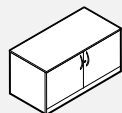

- One lock included.
- Includes one adjustable shelf.
- Optional e-lock available in the horizontal position. Please specify HR - Horizontal Right and add \$304 list.

PRODUCT CODE	FINISH			SIZE/INCHES				WEIGHT LBS	VOL FT <sup>3</sup>
	LP	B	W	H(LP/B)	H(W)	W	D		
L2L2D2030H20	1148	1251	1312	19.94	20.4	30	20	95	11
L2L2D2036H20	1251	1372	1441	19.94	20.4	36	20	106	13
L2L2D2430H20	1196	1300	1367	19.94	20.4	30	24	95	11
L2L2D2436H20	1300	1425	1500	19.94	20.4	36	24	106	13

**L2L2AD • Freestanding 2 Aluminum Doors, 1-High Unit**

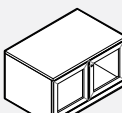

- One lock included.
- Includes one adjustable shelf.
- E-lock not available for aluminum-framed glass doors.

PRODUCT CODE	FINISH			SIZE/INCHES				WEIGHT LBS	VOL FT <sup>3</sup>
	LP	B	W	H(LP/B)	H(W)	W	D		
L2L2AD2030H20	1783	1885	1950	19.5	20	30	20	86	10
L2L2AD2036H20	1938	2061	2130	19.5	20	36	20	96	12
L2L2AD2430H20	1831	1937	2006	19.5	20	30	24	86	10
L2L2AD2436H20	1988	2115	2190	19.5	20	36	24	96	12

**L2L2D • Freestanding 2 Doors, 2-High Unit**

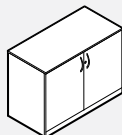

- One lock included.
- Includes one adjustable shelf.
- Optional e-lock available in the horizontal position. Please specify HR - Horizontal Right and add \$304 list.

PRODUCT CODE	FINISH			SIZE/INCHES				WEIGHT LBS	VOL FT <sup>3</sup>
	LP	B	W	H(LP/B)	H(W)	W	D		
L2L2D2030	1267	1407	1445	29	29.5	30	20	171	12
L2L2D2036	1396	1516	1591	29	29.5	36	20	178	14
L2L2D2042	1563	1702	1781	29	29.5	42	20	208	20
L2L2D2430	1316	1466	1504	29	29.5	30	24	171	12
L2L2D2436	1452	1578	1652	29	29.5	36	24	178	14
L2L2D2442	1624	1770	1856	29	29.5	42	24	208	20

**L2L2AD • Freestanding 2 Aluminum Doors, 2-High Unit**

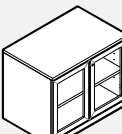

- One lock included.
- Includes one adjustable shelf.
- E-lock not available for aluminum-framed glass doors.

PRODUCT CODE	FINISH			SIZE/INCHES				WEIGHT LBS	VOL FT <sup>3</sup>
	LP	B	W	H(LP/B)	H(W)	W	D		
L2L2AD2030	2053	2197	2234	29	29.5	30	20	165	12
L2L2AD2036	2261	2384	2455	29	29.5	36	20	172	14
L2L2AD2042	2501	2644	2724	29	29.5	42	20	174	20
L2L2AD2430	2104	2254	2293	29	29.5	30	24	165	12
L2L2AD2436	2316	2445	2519	29	29.5	36	24	172	14
L2L2AD2442	2563	2710	2796	29	29.5	42	24	174	20

**L2L1H • Freestanding 1-High Lateral Unit**

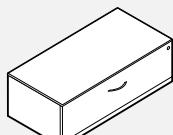

- One lock included.
- Optional e-lock available in the vertical position. Please specify V - Vertical and add \$304 list.

PRODUCT CODE	FINISH			SIZE/INCHES				WEIGHT LBS	VOL FT <sup>3</sup>
	LP	B	W	H(LP/B)	H(W)	W	D		
L2L1H2030	1142	1207	1248	19.94	20.4	30	20	105	11
L2L1H2036	1221	1296	1364	19.94	20.4	36	20	114	13
L2L1H2042	1319	1404	1484	19.94	20.4	42	20	133	15
L2L1H2430	1187	1252	1297	19.94	20.4	30	24	105	11
L2L1H2436	1270	1346	1419	19.94	20.4	36	24	114	13
L2L1H2442	1373	1462	1543	19.94	20.4	42	24	133	15

**L2LBFH20 • Freestanding Box/File Lateral Unit**

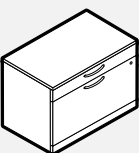

- One lock included.
- Optional e-lock available in the vertical position. Please specify V - Vertical and add \$304 list.

PRODUCT CODE	FINISH			SIZE/INCHES				WEIGHT LBS	VOL FT <sup>3</sup>
	LP	B	W	H(LP/B)	H(W)	W	D		
L2LBF2030H20	1753	1800	1894	19.94	20	30	20	108	11
L2LBF2036H20	1886	1941	2050	19.94	20	36	20	117	13
L2LBF2042H20	2009	2070	2195	19.94	20	42	20	136	15
L2LBF2430H20	1817	1864	1958	19.94	20	30	24	108	11
L2LBF2436H20	1951	2005	2114	19.94	20	36	24	117	13
L2LBF2442H20	2074	2135	2259	19.94	20	42	24	136	15

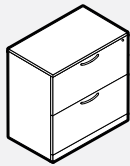
**L2L2H • Freestanding 2-High Lateral Unit**

- One lock included.
- Optional e-lock available in the vertical position. Please specify V - Vertical and add \$304 list.

PRODUCT CODE	FINISH LP	B	W	SIZE/INCHES				D	WEIGHT LBS	VOL FT <sup>3</sup>
				H (LP/B)	H (W)	W	D			
L2L2H2030	1728	1788	1853	29	29.5	30	20	189	12	
L2L2H2036	1852	1922	1991	29	29.5	36	20	209	14	
L2L2H2042	1988	2073	2142	29	29.5	42	20	242	20	
L2L2H2430	1799	1860	1927	29	29.5	30	24	189	12	
L2L2H2436	1923	1997	2071	29	29.5	36	24	209	14	
L2L2H2442	2068	2155	2229	29	29.5	42	24	242	20	

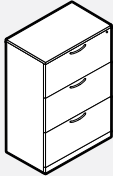
**L2L3H • Freestanding 3-High Lateral Unit**

- One lock included.
- Optional e-lock available in the vertical position. Please specify V - Vertical and add \$304 list.

PRODUCT CODE	FINISH LP	B	W	SIZE/INCHES				D	WEIGHT LBS	VOL FT <sup>3</sup>
				H (LP/B)	H (W)	W	D			
L2L3H2030	2360	2419	2486	41.75	42.18	30	20	252	18	
L2L3H2036	2543	2613	2630	41.75	42.18	36	20	264	21	
L2L3H2430	2456	2516	2584	41.75	42.18	30	24	252	18	
L2L3H2436	2645	2720	2735	41.75	42.18	36	24	264	21	

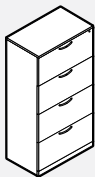
**L2L4H • Freestanding 4-High Lateral Unit**

- One lock included.
- Optional e-lock available in the vertical position. Please specify V - Vertical and add \$304 list.

PRODUCT CODE	FINISH LP	W	D	SIZE/INCHES			WEIGHT LBS	VOL FT <sup>3</sup>
				H (LP/B)	H (W)	W		
L2L4H2030	3051	3178	20	54.5	54.94	30	315	23
L2L4H2036	3206	3390	20	54.5	54.94	36	336	28
L2L4H2430	3172	3303	24	54.5	54.94	30	315	23
L2L4H2436	3334	3525	24	54.5	54.94	36	336	28

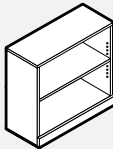
**L2B2H • Bookcase 1 Adjustable Shelf**

- Shipped knocked down (KD).

PRODUCT CODE	FINISH LP	B	W	SIZE/INCHES				D	WEIGHT LBS	VOL FT <sup>3</sup>
				H (LP/B)	H (W)	W	D			
L2B2H3012	676	739	795	29	29.5	30	12	95	8	
L2B2H3612	784	858	932	29	29.5	36	12	106	9	
L2B2H30	806	896	989	29	29.5	30	17	95	11	
L2B2H36	930	1003	1078	29	29.5	36	17	106	13	

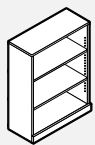
**L2B3H • Bookcase 2 Adjustable Shelves**

- Shipped knocked down (KD).

PRODUCT CODE	FINISH LP	B	W	SIZE/INCHES				D	WEIGHT LBS	VOL FT <sup>3</sup>
				H (LP/B)	H (W)	W	D			
L2B3H3012	865	925	965	41.75	42.18	30	12	160	9	
L2B3H3612	950	1043	1090	41.75	42.18	36	12	171	12	
L2B3H30	1076	1166	1268	41.75	42.18	30	17	160	15	
L2B3H36	1246	1349	1391	41.75	42.18	36	17	171	18	

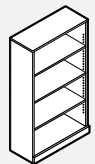
**L2B4H • Bookcase 3 Adjustable Shelves**

- Shipped knocked down (KD).

PRODUCT CODE	FINISH LP	W	D	SIZE/INCHES			WEIGHT LBS	VOL FT <sup>3</sup>
				H (LP/B)	H (W)	W		
L2B4H3012	1033	1176	12	54.5	54.94	30	178	13
L2B4H3612	1157	1321	12	54.5	54.94	36	189	15
L2B4H30	1312	1464	17	54.5	54.94	30	178	19
L2B4H36	1436	1575	17	54.5	54.94	36	189	22

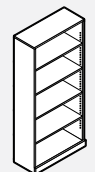
**L2B5H • Bookcase 4 Adjustable Shelves**

- Shipped knocked down (KD).

PRODUCT CODE	FINISH LP	W	D	SIZE/INCHES			WEIGHT LBS	VOL FT <sup>3</sup>
				H (LP/B)	H (W)	W		
L2B5H3012	1245	1386	12	65.81	66.25	30	193	15
L2B5H3612	1356	1526	12	65.81	66.25	36	204	19
L2B5H30	1474	1594	17	65.81	66.25	30	193	23
L2B5H36	1647	1825	17	65.81	66.25	36	204	28

**L2B6H • Bookcase 5 Adjustable Shelves**

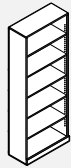

- Shipped knocked down (KD).

PRODUCT CODE	FINISH		SIZE/INCHES				WEIGHT LBS	VOL FT <sup>3</sup>
	LP	W	H(LP/B)	H(W)	W	D		
L2B6H3012	1342	1510	72.81	73.24	30	12	237	17
L2B6H3612	1504	1704	72.81	73.24	36	12	248	20
L2B6H30	1511	1695	72.81	73.24	30	17	242	25
L2B6H36	1806	2067	72.81	73.24	36	17	253	30

**L2BC • Corner Bookcase 20"D x 20"W /24"D x 24"W**

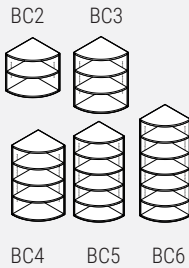

- Shipped knocked down (KD).

PRODUCT CODE	FINISH			SIZE/INCHES				WEIGHT LBS	VOL FT <sup>3</sup>
	LP	B	W	H(LP/B)	H(W)	W	D		
L2BC2H20	1087	1321	1319	29.00	29.50	20	20	90	11
L2BC2H24	1129	1331	1376	29.00	29.50	24	24	90	11
L2BC3H20	1378	1566	1618	41.75	42.18	20	20	125	15
L2BC3H24	1432	1631	1685	41.75	42.18	24	24	125	15
L2BC4H20	1671	-	1916	54.50	54.94	20	20	158	20
L2BC4H24	1738	-	1991	54.50	54.94	24	24	158	20
L2BC5H20	1965	-	2217	65.81	66.25	20	20	188	24
L2BC5H24	2090	-	2304	65.81	66.25	24	24	188	24
L2BC6H20	2207	-	2474	72.81	73.24	20	20	218	26
L2BC6H24	2294	-	2571	72.81	73.24	24	24	218	26

**L2TW2D-D • Storage Tower With 2 Doors and 4 Adjustable Shelves**

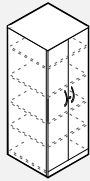

- 50"-High Tower comes with 3 adjustable shelves.
- One lock on right door included.
- Optional e-lock available in the horizontal position. Please specify HR - Horizontal Right and add \$304 list.

PRODUCT CODE	FINISH		SIZE/INCHES				WEIGHT LBS	VOL FT <sup>3</sup>
	LP	W	H(LP/B)	H(W)	W	D		
L2TW2D50H20D	1899	2031	49.56	50.00	24	20	211	22
L2TW2D66H20D	2098	2288	65.81	66.25	24	20	268	24
L2TW2D72H20D	2191	2370	72.81	73.24	24	20	283	26
L2TW2D50H24D	1971	2117	49.56	50.00	24	24	211	22
L2TW2D66H24D	2180	2376	65.81	66.25	24	24	268	24
L2TW2D72H24D	2276	2462	72.81	73.24	24	24	283	26

**L2TW2DCS-D • Storage Tower With 2 Doors, Coat Rod and Hat Shelf**

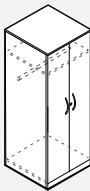

- 50"-High Tower comes with one shelf.
- One lock on right door included.
- Optional e-lock available in the horizontal position. Please specify HR - Horizontal Right and add \$304 list.

PRODUCT CODE	FINISH		SIZE/INCHES				WEIGHT LBS	VOL FT <sup>3</sup>
	LP	W	H(LP/B)	H(W)	W	D		
L2TW2DCS50H20D	1698	1894	49.56	50.00	24	20	178	22
L2TW2DCS66H20D	1922	2063	65.81	66.25	24	20	268	24
L2TW2DCS72H20D	2006	2144	72.81	73.24	24	20	284	26
L2TW2DCS50H24D	1765	1968	49.56	50.00	24	24	178	22
L2TW2DCS66H24D	1996	2141	65.81	66.25	24	24	268	24
L2TW2DCS72H24D	2083	2225	72.81	73.24	24	24	284	26

**L2TW2H2D-D • Storage Tower With a 3-High Cupboard Over a 2-High Lateral Unit**

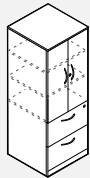

- 50"-High Tower comes with one adjustable shelf.
- Two locks included.
- Optional e-lock available in the vertical position for the file drawers. Please specify V - Vertical and add \$304 list.
- Optional e-lock available in the horizontal position for the upper storage cabinet. Please specify HR - Horizontal Right and add \$304 list.

PRODUCT CODE	FINISH		SIZE/INCHES				WEIGHT LBS	VOL FT <sup>3</sup>
	LP	W	H(LP/B)	H(W)	W	D		
L2TW2H2D50H20D	2569	2622	49.56	50.00	24	20	222	22
L2TW2H2D66H20D	2855	2902	65.81	66.25	24	20	279	24
L2TW2H2D72H20D	2938	3141	72.81	73.24	24	20	295	26
L2TW2H2D50H24D	2673	2730	49.56	50.00	24	24	222	22
L2TW2H2D66H24D	2972	3018	65.81	66.25	24	24	279	24
L2TW2H2D72H24D	3056	3264	72.81	73.24	24	24	295	26

**L2TW3H2D-D • Storage Tower With a 2-High Cupboard Over a 3-High Lateral Unit**

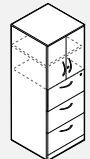

- Two locks included.
- Optional e-lock available in the vertical position for the file drawers. Please specify V - Vertical and add \$304 list.
- Optional e-lock available in the horizontal position for the upper storage cabinet. Please specify HR - Horizontal Right and add \$304 list.

PRODUCT CODE	FINISH		SIZE/INCHES				WEIGHT LBS	VOL FT <sup>3</sup>
	LP	W	H(LP/B)	H(W)	W	D		
L2TW3H2D66H20D	3150	3287	65.81	66.25	24	20	296	24
L2TW3H2D72H20D	3244	3344	72.81	73.24	24	20	311	26
L2TW3H2D66H24D	3274	3418	65.81	66.25	24	24	296	24
L2TW3H2D72H24D	3372	3477	72.81	73.24	24	24	311	26



**L2TW4H2D-D • Tower With a 2-Door Storage Cabinet Over a 4-High Lateral Unit**

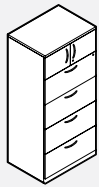

- Two locks included.
- Lock on cupboard is not available for UB, UC or RN handles.
- Optional e-lock available in the vertical position for the file drawers. Please specify V - Vertical and add \$304 list.
- Optional e-lock available in the horizontal position for the upper storage cabinet . Please specify HR - Horizontal Right and add \$304 list.

PRODUCT CODE	FINISH LP	W	SIZE/INCHES				WEIGHT LBS	VOL FT <sup>3</sup>
			H (LP/B)	H (W)	W	D		
L2TW4H2D66H20D	3575	3717	65.81	66.25	24	20	307	24
L2TW4H2D72H20D	3690	3734	72.81	73.24	24	20	322	26
L2TW4H2D66H24D	3718	3864	65.81	66.25	24	24	307	24
L2TW4H2D72H24D	3771	3882	72.81	73.24	24	24	322	26

**L2TWBBF2DL • Storage Tower With a 3-High Cupboard, Box/Box/File Drawers and Wardrobe**

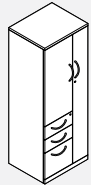

Right Hand Shown

- Storage compartment includes 1 adjustable shelves for 50" h unit and 2 adjustable shelves for 66" h and 72" h units
- Two locks included.
- Optional e-lock available in the vertical position for the box, box, file drawers. Please specify V - Vertical and add \$304 list.
- Optional e-lock available in the horizontal position for the wardrobe. Please specify HR - Horizontal Right or HL - Horizontal Left and add \$304 list.

PRODUCT CODE	FINISH LP	W	SIZE/INCHES				WEIGHT LBS	VOL FT <sup>3</sup>
			H (LP/B)	H (W)	W	D		
<b>Left</b>								
L2TWBBF2DL50H20D	2666	2866	49.56	50.00	24	20	288	20
L2TWBBF2DL66H20D	2969	3107	65.81	66.25	24	20	348	22
L2TWBBF2DL72H20D	3078	3215	72.81	73.25	24	20	378	24
L2TWBBF2DL50H24D	2774	2980	49.5	50.00	24	24	288	20
L2TWBBF2DL66H24D	3087	3231	65.81	66.25	24	24	348	22
L2TWBBF2DL72H24D	3201	3344	72.81	73.25	24	24	378	24
<b>Right</b>								
L2TWBBF2DR50H20D	2666	2866	49.56	50.00	24	20	288	20
L2TWBBF2DR66H20D	2969	3107	65.81	66.25	24	20	348	22
L2TWBBF2DR72H20D	3078	3215	72.81	73.25	24	20	378	24
L2TWBBF2DR50H24D	2774	2980	49.5	50.00	24	24	288	20
L2TWBBF2DR66H24D	3087	3231	65.81	66.25	24	24	348	22
L2TWBBF2DR72H24D	3201	3344	72.81	73.25	24	24	378	24

**L2TW2F2D-D • Storage Tower With a 3-High Cupboard, File/File Drawers and Wardrobe**

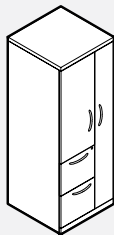

Right Hand Shown

- Wardrobe has a coat rod.
- Two locks included.
- Optional e-lock available in the vertical position for the file drawers. Please specify V - Vertical and add \$304 list.
- Optional e-lock available in the horizontal position for the wardrobe. Please specify HR - Horizontal Right or HL - Horizontal Left and add \$304 list.

PRODUCT CODE	FINISH LP	W	SIZE/INCHES				WEIGHT LBS	VOL FT <sup>3</sup>
			H (LP/B)	H (W)	W	D		
<b>Left</b>								
L2TW2F2DL50H20D	2471	2666	49.56	50.00	24	20	222	22
L2TW2F2DL66H20D	2769	2904	65.81	66.25	24	20	279	24
L2TW2F2DL72H20D	2876	3010	72.81	73.24	24	20	295	26
L2TW2F2DL50H24D	2569	2773	49.56	50.00	24	24	222	22
L2TW2F2DL66H24D	2878	3022	65.81	66.25	24	24	279	24
L2TW2F2DL72H24D	2991	3131	72.81	73.24	24	24	295	26
<b>Right</b>								
L2TW2F2DR50H20D	2471	2666	49.56	50.00	24	20	222	22
L2TW2F2DR66H20D	2769	2904	65.81	66.25	24	20	279	24
L2TW2F2DR72H20D	2876	3010	72.81	73.24	24	20	295	26
L2TW2F2DR50H24D	2569	2773	49.56	50.00	24	24	222	22
L2TW2F2DR66H24D	2878	3022	65.81	66.25	24	24	279	24
L2TW2F2DR72H24D	2991	3131	72.81	73.24	24	24	295	26

**L2TW3F2D-D • Storage Tower With a 2-High Cupboard, File/File/File Drawers and Wardrobe**

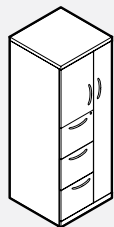

Right Hand Shown

- Two locks included.
- Optional e-lock available in the vertical position for the file drawers. Please specify V - Vertical and add \$304 list.
- Optional e-lock available in the horizontal position for the wardrobe. Please specify HR - Horizontal Right or HL - Horizontal Left and add \$304 list.

PRODUCT CODE	FINISH LP	W	SIZE/INCHES				WEIGHT LBS	VOL FT <sup>3</sup>
			H (LP/B)	H (W)	W	D		
<b>Left</b>								
L2TW3F2DL66H20D	2927	3075	65.81	66.25	24	20	296	24
L2TW3F2DL72H20D	3037	3152	72.81	73.24	24	20	311	26
L2TW3F2DL66H24D	3045	3199	65.81	66.25	24	24	296	24
L2TW3F2DL72H24D	3158	3276	72.81	73.24	24	24	311	26
<b>Right</b>								
L2TW3F2DR66H20D	2927	3075	65.81	66.25	24	20	296	24
L2TW3F2DR72H20D	3037	3152	72.81	73.24	24	20	311	26
L2TW3F2DR66H24D	3045	3199	65.81	66.25	24	24	296	24
L2TW3F2DR72H24D	3158	3276	72.81	73.24	24	24	311	26

**L2TWBFFDO • Storage Tower With 3-High Side-Open Cupboard, Box/Box/File Drawers and Wardrobe**

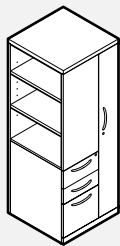

Right Hand Shown

- Open bookcase compartment includes 1 adjustable shelves for 50" unit and 2 adjustable shelves for 66" and 72" units
- Two locks included.
- Optional e-lock available in the vertical position for the box, box, file drawers. Please specify V - Vertical and add \$304 list.
- Optional e-lock available in the horizontal position for the wardrobe. Please specify HR - Horizontal Right or HL - Horizontal Left and add \$304 list.

PRODUCT CODE	FINISH		SIZE/INCHES				WEIGHT LBS	VOL FT <sup>3</sup>
	LP	W	H (LP/B)	H (W)	W	D		
<b>Left</b>								
L2TWBFFDOL50H20D	2481	2635	49.50	50.00	24	20	285	20
L2TWBFFDOL66H20D	2742	2833	65.81	66.25	24	20	345	22
L2TWBFFDOL72H20D	2834	2919	72.81	73.25	24	20	375	24
L2TWBFFDOL50H24D	2579	2740	49.50	50.00	24	24	285	20
L2TWBFFDOL66H24D	2853	2946	65.81	66.25	24	24	345	22
L2TWBFFDOL72H24D	2948	3035	72.81	73.25	24	24	375	24
<b>Right</b>								
L2TWBFFDOR50H20D	2481	2635	49.50	50.00	24	20	285	20
L2TWBFFDOR66H20D	2742	2833	65.81	66.25	24	20	345	22
L2TWBFFDOR72H20D	2834	2919	72.81	73.25	24	20	375	24
L2TWBFFDOR50H24D	2579	2740	49.50	50.00	24	24	285	20
L2TWBFFDOR66H24D	2853	2946	65.81	66.25	24	24	345	22
L2TWBFFDOR72H24D	2948	3035	72.81	73.25	24	24	375	24

**L2TW2FDO-D • Storage Tower With a 3-High Side-Open Cupboard, File/File Drawers and Wardrobe**

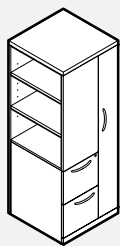

Right Hand Shown

- 50"-High Tower comes with one adjustable shelf.
- Two locks included.
- Optional e-lock available in the vertical position for the file drawers. Please specify V - Vertical and add \$304 list.
- Optional e-lock available in the horizontal position for the wardrobe. Please specify HR - Horizontal Right or HL - Horizontal Left and add \$304 list.

PRODUCT CODE	FINISH		SIZE/INCHES				WEIGHT LBS	VOL FT <sup>3</sup>
	LP	W	H (LP/B)	H (W)	W	D		
<b>Left</b>								
L2TW2FDOL50H20D	2288	2440	49.56	50.00	24	20	211	22
L2TW2FDOL66H20D	2548	2635	65.81	66.25	24	20	268	24
L2TW2FDOL72H20D	2637	2720	72.81	73.24	24	20	284	26
L2TW2FDOL50H24D	2384	2536	49.56	50.00	24	24	211	22
L2TW2FDOL66H24D	2649	2738	65.81	66.25	24	24	268	24
L2TW2FDOL72H24D	2740	2829	72.81	73.24	24	24	284	26
<b>Right</b>								
L2TW2FDOR50H20D	2288	2440	49.56	50.00	24	20	211	22
L2TW2FDOR66H20D	2548	2635	65.81	66.25	24	20	268	24
L2TW2FDOR72H20D	2637	2720	72.81	73.24	24	20	284	26
L2TW2FDOR50H24D	2384	2536	49.56	50.00	24	24	211	22
L2TW2FDOR66H24D	2649	2738	65.81	66.25	24	24	268	24
L2TW2FDOR72H24D	2741	2829	72.81	73.24	24	24	284	26

**L2TW3FDO-D • Storage Tower With a 2-High Side-Open Cupboard, File/File/File Drawers and Wardrobe**

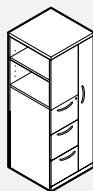

Right Hand Shown

- Two locks included.
- Optional e-lock available in the vertical position for the file drawers. Please specify V - Vertical and add \$304 list.
- Optional e-lock available in the horizontal position for the wardrobe. Please specify HR - Horizontal Right or HL - Horizontal Left and add \$304 list.

PRODUCT CODE	FINISH		SIZE/INCHES				WEIGHT LBS	VOL FT <sup>3</sup>
	LP	W	H (LP/B)	H (W)	W	D		
<b>Left</b>								
L2TW3FDOL66H20D	2751	2942	65.81	66.25	24	20	285	24
L2TW3FDOL72H20D	2921	2943	72.81	73.24	24	20	300	26
L2TW3FDOL66H24D	2860	3061	65.81	66.25	24	24	285	24
L2TW3FDOL72H24D	3038	3058	72.81	73.24	24	24	300	26
<b>Right</b>								
L2TW3FDOR66H20D	2751	2942	65.81	66.25	24	20	285	24
L2TW3FDOR72H20D	2921	2943	72.81	73.24	24	20	300	26
L2TW3FDOR66H24D	2860	3061	65.81	66.25	24	24	285	24
L2TW3FDOR72H24D	3038	3058	72.81	73.24	24	24	300	26

**L2TWA2DCS • Storage Tower With 2 Aluminum Doors, Coat Rod and Hat Shelf**

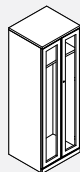

- 50"-High Tower comes with 1 shelf above hang rod.
- One lock included.
- E-locks not available for aluminum-framed glass doors.

PRODUCT CODE	FINISH		SIZE/INCHES				WEIGHT LBS	VOL FT <sup>3</sup>
	LP	W	H (LP/B)	H (W)	W	D		
L2TWA2DCS50H20D	2783	2984	49.56	50.00	24	20	162	20
L2TWA2DCS66H20D	3247	3390	65.81	66.25	24	20	244	22
L2TWA2DCS72H20D	3418	3563	72.81	73.25	24	20	258	24
L2TWA2DCS50H24D	2851	3054	49.56	50.00	24	24	162	20
L2TWA2DCS66H24D	3323	3470	65.81	66.25	24	24	244	22
L2TWA2DCS72H24D	3499	3643	72.81	73.25	24	24	258	24

**L2TWA2D • Storage Tower With 2 Aluminum Doors and 4 Adjustable Shelves**

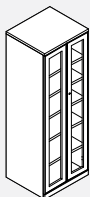

- 50"-High Tower comes with 3 adjustable shelves.
- One lock included.
- E-locks not available for aluminum-framed glass doors.

PRODUCT CODE	FINISH		SIZE/INCHES				WEIGHT LBS	VOL FT <sup>3</sup>
	LP	W	H (LP/B)	H (W)	W	D		
L2TWA2D50H20D	2988	3127	49.56	50.00	24	20	192	20
L2TWA2D66H20D	3427	3618	65.81	66.25	24	20	244	22
L2TWA2D72H20D	3609	3790	72.81	73.25	24	20	257	24
L2TWA2D50H24D	3062	3207	49.56	50.00	24	24	192	20
L2TWA2D66H24D	3510	3707	65.81	66.25	24	24	244	22
L2TWA2D72H24D	3695	3882	72.81	73.25	24	24	257	24

**L2TWA2H2D • Storage Tower With a 3-High Cupboard Over a 2-High Lateral Unit**

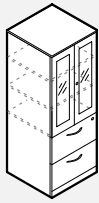

- 50"-High Tower comes with 1 adjustable shelf.
- Lock is on the upper drawer.
- Two locks included.
- Optional e-lock available in the vertical position. Please specify V - Vertical and add \$304 list.
- E-locks not available for aluminum-framed glass doors.

PRODUCT CODE	FINISH		SIZE/INCHES				WEIGHT LBS	VOL FT <sup>3</sup>
	LP	W	H (LP/B)	H (W)	W	D		
L2TWA2H2D50H20D	3258	3312	49.56	50.00	24	20	202	20
L2TWA2H2D66H20D	3783	3828	65.81	66.25	24	20	254	22
L2TWA2H2D72H20D	3955	4160	72.81	73.25	24	20	258	24
L2TWA2H2D50H24D	3363	3420	49.56	50.00	24	24	202	20
L2TWA2H2D66H24D	3901	3947	65.81	66.25	24	24	254	22
L2TWA2H2D72H24D	4075	4285	72.81	73.25	24	24	258	24

**L2TWA3H2D • Storage Tower With a 2-High Cupboard With Aluminum Doors Over a 3-High Lateral Unit**

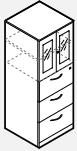

- Lock is on the upper drawer.
- Two locks included.
- Optional e-lock available in the vertical position. Please specify V - Vertical and add \$304 list.
- E-locks not available for aluminum-framed glass doors.

PRODUCT CODE	FINISH		SIZE/INCHES				WEIGHT LBS	VOL FT <sup>3</sup>
	LP	W	H (LP/B)	H (W)	W	D		
L2TWA3H2D66H20D	3892	4033	65.81	66.25	24	20	269	22
L2TWA3H2D72H20D	4076	4178	72.81	73.25	24	20	283	24
L2TWA3H2D66H24D	4020	4165	65.81	66.25	24	24	269	22
L2TWA3H2D72H24D	4208	4314	72.81	73.25	24	24	283	24

**L2TWA4H2D • Storage Tower With Cupboard With Aluminum Doors Over a 4-High Lateral Unit**

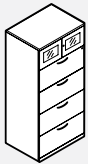

- Lock is on the upper drawer.
- Two locks included.
- Optional e-lock available in the vertical position. Please specify V - Vertical and add \$304 list.
- E-locks not available for aluminum-framed glass doors.

PRODUCT CODE	FINISH		SIZE/INCHES				WEIGHT LBS	VOL FT <sup>3</sup>
	LP	W	H (LP/B)	H (W)	W	D		
L2TWA4H2D66H20D	4068	4211	65.81	66.25	24	20	279	22
L2TWA4H2D72H20D	4285	4332	72.81	73.25	24	20	293	24
L2TWA4H2D66H24D	4213	4360	65.81	66.25	24	24	293	22
L2TWA4H2D72H24D	4436	4483	72.81	73.25	24	24	293	24

**L2TWA2F2D • Storage Tower With a 3-High Cupboard, File/File Drawers and Wardrobe**

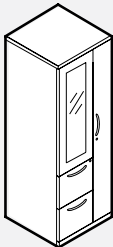

Right Hand Shown

- Storage compartment includes 1 adjustable shelves for 50"h unit and 2 adjustable shelves for 66"h and 72"h units
- Two locks included.
- Optional e-lock available in the vertical position for the file drawers. Please specify V - Vertical and add \$304 list.
- Optional e-lock available in the horizontal position for the wardrobe. Please specify HR - Horizontal Right or HL - Horizontal Left and add \$304 list.
- E-locks not available for aluminum-framed glass doors.

PRODUCT CODE	FINISH		SIZE/INCHES				WEIGHT LBS	VOL FT <sup>3</sup>
	LP	W	H (LP/B)	H (W)	W	D		
L2TWA2F2DR50H20D	2834	3034	49.56	50.00	24	20	219	20
L2TWA2F2DR66H20D	3278	3415	65.81	66.25	24	20	276	22
L2TWA2F2DR72H20D	3438	3575	72.81	73.25	24	20	292	24
L2TWA2F2DR50H24D	2936	3142	49.56	50.00	24	24	219	20
L2TWA2F2DR66H24D	3391	3531	65.81	66.25	24	24	276	22
L2TWA2F2DR72H24D	3556	3698	72.81	73.25	24	24	292	24
L2TWA2F2DL50H20D	2834	3034	49.56	50.00	24	20	219	20
L2TWA2F2DL66H20D	3278	3415	65.81	66.25	24	20	276	22
L2TWA2F2DL72H20D	3438	3575	72.81	73.25	24	20	292	24
L2TWA2F2DL50H24D	2936	3142	49.56	50.00	24	24	219	20
L2TWA2F2DL66H24D	3391	3531	65.81	66.25	24	24	276	22
L2TWA2F2DL72H24D	3556	3698	72.81	73.25	24	24	292	24

**L2TWABBF2D • Storage Tower With a 3-High Cupboard, Box/Box/File Drawers and Wardrobe**

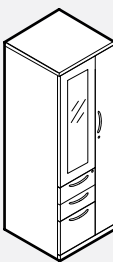

Right Hand Shown

- Storage compartment includes 1 adjustable shelves for 50"h unit and 2 adjustable shelves for 66"h and 72"h units
- Two locks included.
- Optional e-lock available in the vertical position for the box, box, file drawers. Please specify V - Vertical and add \$304 list.
- Optional e-lock available in the horizontal position for the wardrobe. Please specify HR - Horizontal Right or HL - Horizontal Left and add \$304 list.
- E-locks not available for aluminum-framed glass doors.

PRODUCT CODE	FINISH		SIZE/INCHES				WEIGHT LBS	VOL FT <sup>3</sup>
	LP	W	H (LP/B)	H (W)	W	D		
L2TWABBF2DL50H20D	2995	3195	49.56	50.00	24	20	288	20
L2TWABBF2DL66H20D	3438	3574	65.81	66.25	24	20	348	22
L2TWABBF2DL72H20D	3598	3736	72.81	73.25	24	20	378	24
L2TWABBF2DL50H24D	3094	3302	49.56	50.00	24	24	288	20
L2TWABBF2DL66H24D	3552	3692	65.81	66.25	24	24	348	22
L2TWABBF2DL72H24D	3717	3859	72.81	73.25	24	24	378	24
L2TWABBF2DR50H20D	2995	3195	49.56	50.00	24	20	288	20
L2TWABBF2DR66H20D	3438	3574	65.81	66.25	24	20	348	22
L2TWABBF2DR72H20D	3598	3736	72.81	73.25	24	20	378	24
L2TWABBF2DR50H24D	3094	3302	49.56	50.00	24	24	288	20
L2TWABBF2DR66H24D	3552	3692	65.81	66.25	24	24	348	22
L2TWABBF2DR72H24D	3717	3859	72.81	73.25	24	24	378	24

**L2TW3F2D-D • Storage Tower With a 2-High Cupboard, File/File/File Drawers and Wardrobe**

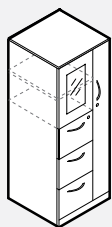

- Lock is on the upper drawer.
- Storage compartment includes 1 adjustable shelf.
- Two locks included.
- Optional e-lock available in the vertical position for the file drawers. Please specify V - Vertical and add \$304 list.
- Optional e-lock available in the horizontal position for the wardrobe. Please specify HR - Horizontal Right or HL - Horizontal Left and add \$304 list.
- E-locks not available for aluminum-framed glass doors.

PRODUCT CODE	FINISH		SIZE/INCHES				WEIGHT		VOL FT <sup>3</sup>
	LP	W	H (LP/B)	H (W)	W	D	LBS		
L2TWA3F2DR66H20D	3358	3504	65.81	66.25	24	20	340	22	
L2TWA3F2DR72H20D	3514	3654	72.81	73.25	24	20	370	24	
L2TWA3F2DR66H24D	3479	3631	65.81	66.25	24	24	340	22	
L2TWA3F2DR72H24D	3638	3758	72.81	73.25	24	24	370	24	
L2TWA3F2DL66H20D	3358	3504	65.81	66.25	24	20	340	22	
L2TWA3F2DL72H20D	3514	3631	72.81	73.25	24	20	370	24	
L2TWA3F2DL66H24D	3479	3654	65.81	66.25	24	24	340	22	
L2TWA3F2DL72H24D	3638	3758	72.81	73.25	24	24	370	24	

**L2CB • Storage Cabinet With 2 Doors and 4 Adjustable Shelves**

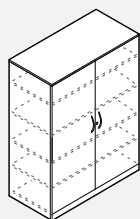

- 50"h. cabinet comes with 3 adjustable shelves.
- 66"h. and 72"h. Cabinet comes with 4 adjustable shelves.
- One lock included.
- Optional e-lock available in the horizontal position. Please specify HR - Horizontal Right and add \$304 list.

PRODUCT CODE	FINISH		SIZE/INCHES				WEIGHT		VOL FT <sup>3</sup>
	LP	W	H (LP/B)	H (W)	W	D	LBS		
L2CB20302D50H	2163	2341	49.56	50.00	30	20	245	21	
L2CB20362D50H	2315	2522	49.56	50.00	36	20	281	25	
L2CB20302D66H	2456	2630	65.81	66.25	30	20	310	28	
L2CB20362D66H	2640	2840	65.81	66.25	36	20	354	33	
L2CB20302D72H	2553	2724	72.81	73.24	30	20	327	30	
L2CB20362D72H	2738	2938	72.81	73.24	36	20	372	36	
L2CB24302D50H	2249	2434	49.56	50.00	30	24	245	25	
L2CB24362D50H	2407	2621	49.56	50.00	36	24	281	30	
L2CB24302D66H	2557	2735	65.81	66.25	30	24	310	33	
L2CB24362D66H	2746	2954	65.81	66.25	36	24	354	39	
L2CB24302D72H	2655	2833	72.81	73.24	30	24	327	36	
L2CB24362D72H	2850	3056	72.81	73.24	36	24	372	43	

**L2CB • Storage Cabinet With 2 Doors, Coat Rod and 1 Fixed Shelf**

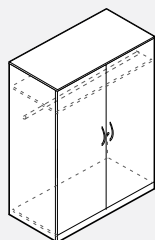

- One lock included.
- Optional e-lock available in the horizontal position. Please specify HR - Horizontal Right and add \$304 list.

PRODUCT CODE	FINISH		SIZE/INCHES				WEIGHT		VOL FT <sup>3</sup>
	LP	W	H (LP/B)	H (W)	W	D	LBS		
L2CB20302DCS50H	1977	2141	49.56	50.00	30	20	204	21	
L2CB20362DCS50H	2088	2287	49.56	50.00	36	20	231	25	
L2CB20302DCS66H	2168	2374	65.81	66.25	30	20	249	28	
L2CB20362DCS66H	2283	2483	65.81	66.25	36	20	281	33	
L2CB20302DCS72H	2262	2600	72.81	73.24	30	20	265	30	
L2CB20362DCS72H	2386	2586	72.81	73.24	36	20	298	36	
L2CB24302DCS50H	2056	2228	49.56	50.00	30	24	204	25	
L2CB24362DCS50H	2171	2378	49.56	50.00	36	24	231	30	
L2CB24302DCS66H	2254	2471	65.81	66.25	30	24	249	33	
L2CB24362DCS66H	2373	2579	65.81	66.25	36	24	281	39	
L2CB24302DCS72H	2354	2702	72.81	73.24	30	24	265	36	
L2CB24362DCS72H	2481	2689	72.81	73.24	36	24	298	43	

**L2CB • Storage Cabinet With 3-High Cupboard, 2 Adjustable Shelves Over a 2-High Lateral Unit**

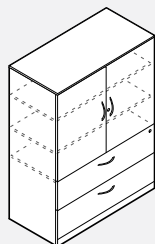

- 50"h. cabinet comes with one adjustable shelf.
- 66" and 72" Cabinet comes with 2 adjustable shelves.
- Two locks included.
- Optional e-lock available for the file drawers vertical position. Please specify V - Vertical and add \$304 list.
- Optional e-lock available in the horizontal position for upper storage cabinet. Please specify HR - Horizontal Right and add \$304 list.

PRODUCT CODE	FINISH		SIZE/INCHES				WEIGHT		VOL FT <sup>3</sup>
	LP	W	H (LP/B)	H (W)	W	D	LBS		
L2CB20302H2D50H	2811	2967	49.56	50.00	30	20	256	21	
L2CB20362H2D50H	2988	3129	49.56	50.00	36	20	292	25	
L2CB20302H2D66H	3146	3305	65.81	66.25	30	20	321	28	
L2CB20362H2D66H	3352	3488	65.81	66.25	36	20	365	33	
L2CB20302H2D72H	3245	3405	72.81	73.24	30	20	338	30	
L2CB20362H2D72H	3422	3584	72.81	73.24	36	20	383	36	
L2CB24302H2D50H	2921	3086	49.56	50.00	30	24	256	25	
L2CB24362H2D50H	3108	3253	49.56	50.00	36	24	292	30	
L2CB24302H2D66H	3272	3438	65.81	66.25	30	24	321	33	
L2CB24362H2D66H	3485	3631	65.81	66.25	36	24	365	39	
L2CB24302H2D72H	3377	3540	72.81	73.24	30	24	338	36	
L2CB24362H2D72H	3558	3728	72.81	73.24	36	24	383	43	

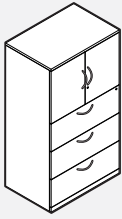
**L2CB • Storage Cabinet With a 2-High Cupboard, 1 Adjustable Shelf Over a 3-High Lateral Unit**

- One lock on right door.
- Two locks included.
- Optional e-lock available for the file drawers vertical position. Please specify V - Vertical and add \$304 list.
- Optional e-lock available in the horizontal position for upper storage cabinet. Please specify HR - Horizontal Right and add \$304 list.

PRODUCT CODE	FINISH LP	W	SIZE/INCHES			D	WEIGHT LBS	VOL FT <sup>3</sup>
			H (LP/B)	H (W)	W			
L2CB20303H2D66H	3345	3508	65.81	66.25	30	20	337	28
L2CB20363H2D66H	3556	3749	65.81	66.25	36	20	381	33
L2CB20303H2D72H	3479	3641	72.81	73.25	30	20	354	30
L2CB20363H2D72H	3686	3884	72.81	73.25	36	20	399	36
L2CB24303H2D66H	3480	3649	65.81	66.25	30	24	337	28
L2CB24363H2D66H	3698	3900	65.81	66.25	36	24	381	33
L2CB24303H2D72H	3617	3787	72.81	73.25	30	24	354	30
L2CB24363H2D72H	3834	4041	72.81	73.25	36	24	399	36

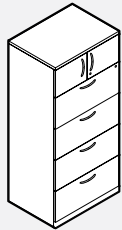
**L2CB • Storage Cabinet With a 2-Door Storage Cupboard above a 4-High Lateral Unit**

- Two locks included.
- Lock on cupboard is not available for UB, UC or RN handles.
- Optional e-lock available for the file drawers vertical position. Please specify V - Vertical and add \$304 list.
- Optional e-lock available in the horizontal position for upper storage cabinet. Please specify HR - Horizontal Right and add \$304 list.

PRODUCT CODE	FINISH LP	W	SIZE/INCHES			D	WEIGHT LBS	VOL FT <sup>3</sup>
			H (LP/B)	H (W)	W			
L2CB20304H2D66H	3795	3992	65.81	66.25	30	20	343	28
L2CB20364H2D66H	4095	4294	65.81	66.25	36	20	387	33
L2CB20304H2D72H	3896	4064	72.81	73.24	30	20	360	30
L2CB20364H2D72H	4135	4334	72.81	73.24	36	20	405	36
L2CB24304H2D66H	3950	4152	65.81	66.25	30	24	278	33
L2CB24364H2D66H	4259	4467	65.81	66.25	36	24	314	39
L2CB24304H2D72H	4052	4226	72.81	73.24	30	24	343	36
L2CB24364H2D72H	4301	4507	72.81	73.24	36	24	387	43

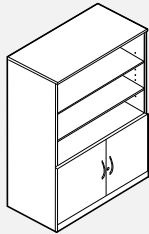
**L2CB • Storage Cabinet With Open Bookcase and 2 Adjustable Shelves and 2-Door Cupboard**

- 50" h cabinet comes with one adjustable shelf.
- 66" h and 72" h. Cabinet comes with 2 adjustable Shelves.
- One lock included.
- Optional e-lock available in the horizontal position. Please specify HR - Horizontal Right and add \$304 list.

PRODUCT CODE	FINISH LP	W	SIZE/INCHES			D	WEIGHT LBS	VOL FT <sup>3</sup>
			H (LP/B)	H (W)	W			
L2CB20302D050H	1814	2056	49.56	50.00	30	20	212	21
L2CB20362D050H	1938	2276	49.56	50.00	36	20	248	25
L2CB20302D066H	2035	2342	65.81	66.25	30	20	277	28
L2CB20362D066H	2498	2656	65.81	66.25	36	20	321	33
L2CB20302D072H	2103	2436	72.81	73.24	30	20	294	30
L2CB20362D072H	2294	2754	72.81	73.24	36	20	339	36
L2CB24302D050H	1905	2158	49.56	50.00	30	24	212	25
L2CB24362D050H	2035	2391	49.56	50.00	36	24	248	30
L2CB24302D066H	2137	2460	65.81	66.25	30	24	277	33
L2CB24362D066H	2306	2789	65.81	66.25	36	24	321	39
L2CB24302D072H	2207	2557	72.81	73.24	30	24	294	36
L2CB24362D072H	2407	2893	72.81	73.24	36	24	339	43

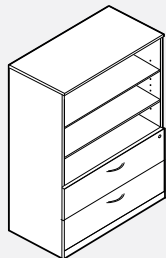
**L2CB • Storage Cabinet With Open Bookcase and 2 Adjustable Shelves Over a 2-High Lateral Unit**

- 50" h cabinet comes with one adjustable shelf.
- 66" h and 72" h. Cabinet comes with 2 adjustable Shelves.
- One lock included.
- Optional e-lock available in the vertical position. Please specify V - Vertical and add \$304 list.

PRODUCT CODE	FINISH LP	W	SIZE/INCHES			D	WEIGHT LBS	VOL FT <sup>3</sup>
			H (LP/B)	H (W)	W			
L2CB20302H050H	2191	2351	49.56	50.00	30	20	226	21
L2CB20362H050H	2300	2471	49.56	50.00	36	20	261	25
L2CB20302H066H	2414	2573	65.81	66.25	30	20	290	28
L2CB20362H066H	2610	2714	65.81	66.25	36	20	334	33
L2CB20302H072H	2509	2554	72.81	73.24	30	20	307	30
L2CB20362H072H	2677	2779	72.81	73.24	36	20	352	36
L2CB24302H050H	2299	2470	49.56	50.00	30	24	226	25
L2CB24362H050H	2414	2596	49.56	50.00	36	24	261	30
L2CB24302H066H	2533	2702	65.81	66.25	30	24	290	33
L2CB24362H066H	2738	2848	65.81	66.25	36	24	334	39
L2CB24302H072H	2632	2682	72.81	73.24	30	24	307	36
L2CB24362H072H	2811	2918	72.81	73.24	36	24	352	43

**L2CBA • Storage Cabinet With 2 Doors and 4 Adjustable Shelves**

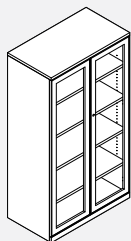

- One lock included.
- Door frame is anodized aluminum.
- Glazing is frosted acrylic.
- Doors standard with no handles.
- E-locks not available for aluminum-framed glass doors.

PRODUCT CODE	FINISH LP	W	SIZE / INCHES				WEIGHT		VOL FT <sup>3</sup>
			H (LP/B)	H (W)	W	D	LBS		
L2CBA20302D50H	3379	3560	49.56	50.00	30	20	235	21	
L2CBA20362D50H	3660	3871	49.56	50.00	36	20	281	25	
L2CBA20302D66H	3947	4123	65.81	66.25	30	20	300	28	
L2CBA20362D66H	4295	4500	65.81	66.25	36	20	344	33	
L2CBA20302D72H	4147	4322	72.81	73.25	30	20	317	30	
L2CBA20362D72H	4508	4712	72.81	73.25	36	20	362	36	
L2CBA24302D50H	3467	3655	49.56	50.00	30	24	235	21	
L2CBA24362D50H	3753	3969	49.56	50.00	36	24	281	25	
L2CBA24302D66H	4048	4230	65.81	66.25	30	24	300	28	
L2CBA24362D66H	4399	4611	65.81	66.25	36	24	344	33	
L2CBA24302D72H	4252	4431	72.81	73.25	30	24	317	30	
L2CBA24362D72H	4621	4832	72.81	73.25	36	24	362	36	

**L2CBA • Storage Cabinet With 2 Doors, Coat Rod and 1 Adjustable Shelf**

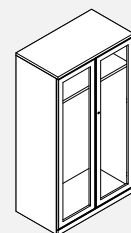

- One lock included.
- Door frame is anodized aluminum.
- Glazing is frosted acrylic.
- Doors standard with no handles.
- E-locks not available for aluminum-framed glass doors.

PRODUCT CODE	FINISH LP	W	SIZE / INCHES				WEIGHT		VOL FT <sup>3</sup>
			H (LP/B)	H (W)	W	D	LBS		
L2CBA20302DCS50H	3195	3359	49.56	50.00	30	20	195	21	
L2CBA20362DCS50H	3427	3631	49.56	50.00	36	20	221	25	
L2CBA20302DCS66H	3654	3864	65.81	66.25	30	20	239	28	
L2CBA20362DCS66H	3931	4134	65.81	66.25	36	20	271	33	
L2CBA20302DCS72H	3854	4197	72.81	73.25	30	20	255	30	
L2CBA20362DCS72H	4152	4352	72.81	73.25	36	20	288	36	
L2CBA24302DCS50H	3274	3448	49.56	50.00	30	24	195	21	
L2CBA24362DCS50H	3512	3723	49.56	50.00	36	24	221	25	
L2CBA24302DCS66H	3742	3962	65.81	66.25	30	24	239	28	
L2CBA24362DCS66H	4022	4232	65.81	66.25	36	24	271	33	
L2CBA24302DCS72H	3947	4300	72.81	73.25	30	24	255	30	
L2CBA24362DCS72H	4248	4460	72.81	73.25	36	24	288	36	

**L2CBA • Storage Cabinet With 3-High Cupboard, 2 Adjustable Shelves Over a 2-High Lateral Unit**

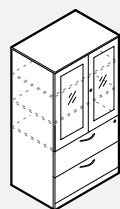

- Cabinet 2h2d.
- One lock on right door.
- One lock on upper drawer.
- Door frame is anodized aluminum with lock(s).
- Glazing is frosted acrylic.
- Doors standard with no handles.
- Two locks included.
- Optional e-lock available in the vertical position. Please specify V-Vertical and add \$304 list.
- E-locks not available for aluminum-framed glass doors.

PRODUCT CODE	FINISH LP	W	SIZE / INCHES				WEIGHT		VOL FT <sup>3</sup>
			H (LP/B)	H (W)	W	D	LBS		
L2CBA20302H2D50H	3568	3728	49.56	50.00	30	20	233	19	
L2CBA20362H2D50H	3810	3956	49.56	50.00	36	20	265	22	
L2CBA20302H2D66H	4176	4339	65.81	66.25	30	20	292	25	
L2CBA20362H2D66H	4484	4674	65.81	66.25	36	20	332	29	
L2CBA20302H2D72H	4377	4540	72.81	73.25	30	20	307	27	
L2CBA20362H2D72H	4669	4832	72.81	73.25	36	20	348	32	
L2CBA24302H2D50H	3682	3847	49.56	50.00	30	24	233	22	
L2CBA24362H2D50H	3933	4082	49.56	50.00	36	24	265	27	
L2CBA24302H2D66H	4305	4473	65.81	66.25	30	24	292	29	
L2CBA24362H2D66H	4621	4819	65.81	66.25	36	24	332	35	
L2CBA24302H2D72H	4508	4676	72.81	73.25	30	24	307	32	
L2CBA24362H2D72H	4808	4980	72.81	73.25	36	24	348	38	

**L2CBA • Storage Cabinet With 2-High Cupboard, 1 Adjustable Shelf Over a 3-High Lateral Unit**

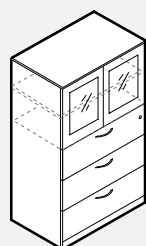

- Cabinet 3h2d.
- One lock on right door.
- One lock on upper drawer.
- Door frame is anodized aluminum with lock(s).
- Glazing is frosted acrylic.
- Doors standard with no handles.
- Two locks included.
- Optional e-lock available in the vertical position. Please specify V-Vertical and add \$304 list.
- E-locks not available for aluminum-framed glass doors.

PRODUCT CODE	FINISH LP	W	SIZE / INCHES				WEIGHT		VOL FT <sup>3</sup>
			H (LP/B)	H (W)	W	D	LBS		
L2CBA20303H2D66H	4117	4280	65.81	66.25	30	20	337	28	
L2CBA20363H2D66H	4398	4592	65.81	66.25	36	20	381	33	
L2CBA20303H2D72H	4351	4513	72.81	73.25	30	20	354	30	
L2CBA20363H2D72H	4643	4842	72.81	73.25	36	20	399	36	
L2CBA24303H2D66H	4252	4420	65.81	66.25	30	24	337	28	
L2CBA24363H2D66H	4541	4742	65.81	66.25	36	24	381	33	
L2CBA24303H2D72H	4489	4659	72.81	73.25	30	24	354	30	
L2CBA24363H2D72H	4792	4998	72.81	73.25	36	24	399	36	

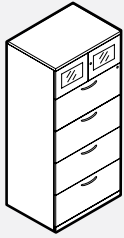
**L2CBA • Storage Cabinet With 2 Aluminum Door Storage Cupboard Above a 4-High Lateral Unit**

- Two locks included.
- Door frame is anodized aluminum.
- Glazing is frosted acrylic.
- Doors standard with no handles.
- One lock on right door.
- One lock on upper drawer.
- Optional e-lock available in the vertical position. Please specify V - Vertical and add \$304 list.
- E-locks not available for aluminum-framed glass doors.

PRODUCT CODE	FINISH		SIZE/INCHES				WEIGHT VOL	
	LP	W	H (LP/B)	H (W)	W	D	LBS	FT <sup>3</sup>
L2CBA20304H2D66H	4381	4577	65.81	66.25	30	20	343	28
L2CBA20364H2D66H	4815	5018	65.81	66.25	36	20	387	33
L2CBA20304H2D72H	4593	4764	72.81	73.25	30	20	360	30
L2CBA20364H2D72H	4894	5093	72.81	73.25	36	20	345	36
L2CBA24304H2D66H	4535	4739	65.81	66.25	30	24	343	28
L2CBA24364H2D66H	4981	5192	65.81	66.25	36	24	387	33
L2CBA24304H2D72H	4751	4929	72.81	73.25	30	24	360	30
L2CBA24364H2D72H	5061	5269	72.81	73.25	36	24	345	36

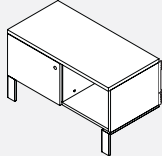
**L2BRTPSLSxx • Panel-Supporting Lateral Sliding Door**

- Fits below a 29" high table, can join with other 21" high, 18" and 23" deep storage units along the panel. Can serve as an additional worksurface or an ad-hoc guest seating with optional cushion.
- Storage compartment internal height: 12.36".
- Sliding door locks on left side.
- Anodized aluminum leg upcharge \$74.
- Optional e-lock available in the vertical position. Please specify V - Vertical and add \$304 list.

PRODUCT CODE	FINISH GROUP		SIZE/INCHES				WEIGHT VOL	
	LP	HP	H	W	D	LBS	FT <sup>3</sup>	
L2BRTPSLS30	1367	1456	1186	30	19	53	6.56	
L2BRTPSLS36	1477	1567	1277	36	19	60	7.87	
L2BRTPSLS42	1590	1678	1367	42	19	67	9.18	
L2BRTPSLS2330	1821	1941	1581	30	24	61	8.39	
L2BRTPSLS2336	1970	2088	1701	36	24	70	10.06	
L2BRTPSLS2342	2119	2239	1824	42	24	79	11.74	

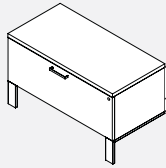
**L2BRTPSLxx • Panel-Supporting Lateral File Drawer**

- Fits below a 29" high table, can join with other 21" high, 18" and 23" deep storage units along the panel. Can serve as an additional worksurface or an ad-hoc guest seating with optional cushion.
- One file drawer (holds letter, legal and A4 suspended file folders).
- Anodized aluminum leg upcharge \$74.
- Optional e-lock available in the vertical position. Please specify V - Vertical and add \$304 list.

PRODUCT CODE	FINISH GROUP		SIZE/INCHES				WEIGHT VOL	
	LP	HP	H	W	D	LBS	FT <sup>3</sup>	
L2BRTPSL30	1412	1432	1167	30	19	77	6.56	
L2BRTPSL36	1544	1634	1331	36	19	84	7.87	
L2BRTPSL42	1701	1790	1458	42	19	92	9.18	
L2BRTPSL2330	1879	1910	1556	30	24	86	8.39	
L2BRTPSL2336	2058	2179	1775	36	24	95	10.06	
L2BRTPSL2342	2277	2387	1945	42	24	104	11.74	

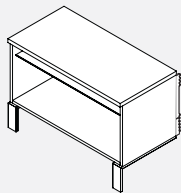
**L2BRTP25LOxxL • Panel-Supporting Open Storage**

- Fits below a 29" high table, can join with other 25" high, 18" and 23" deep storage units along the panel. Can serve as an additional worksurface or an ad-hoc guest seating with optional cushion.
- Open compartment with glass adjustable shelf. Storage compartment internal height without height-adjustable shelf: 15.8"
- Anodized aluminum leg upcharge \$74.

PRODUCT CODE	FINISH GROUP		SIZE/INCHES				WEIGHT VOL	
	LP	HP	H	W	D	LBS	FT <sup>3</sup>	
L2BRTP25LO30L	783	939	765	30	19	49	7.81	
L2BRTP25LO36L	984	1073	874	36	19	55	9.37	
L2BRTP25LO42L	1073	1187	967	42	19	62	10.93	
L2BRTP25LO2330L	1046	1253	1021	30	24	59	10.42	
L2BRTP25LO2336L	1312	1432	1167	36	24	66	12.50	
L2BRTP25LO2342L	1432	1581	1288	42	24	72	14.58	

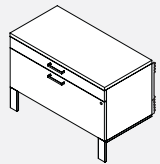
**L2BRTPPLBFxx • Panel-Supporting Lateral Box/File**

- Fits below a 29" high table, can join with other 25" high, 18" and 23" deep storage units along the panel.
- One lockable file drawer (holds letter, legal and A4 suspended file folders), one box drawer.
- Anodized aluminum leg upcharge \$74.
- Black injection moulded pencil tray included (can be secured inside the drawer anywhere along the perimeter wall).
- Optional e-lock available in the vertical position. Please specify V - Vertical and add \$304 list.

PRODUCT CODE	FINISH GROUP		SIZE/INCHES				WEIGHT VOL	
	LP	HP	H	W	D	LBS	FT <sup>3</sup>	
L2BRTPPLBF30	1523	1613	1314	30	19	88	7.81	
L2BRTPPLBF36	1745	1835	1495	36	19	96	9.37	
L2BRTPPLBF42	1904	2014	1641	42	19	104	10.93	
L2BRTPPLBF2330	2136	2239	1824	30	24	98	10.42	
L2BRTPPLBF2336	2327	2445	1992	36	24	107	12.50	
L2BRTPPLBF2342	2538	2686	2188	42	24	116	14.58	

**L2BRT25L2Dxxxx • Panel-Supporting Lateral With Hinged Doors**

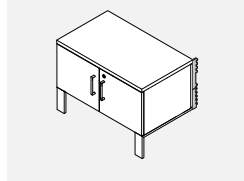

- Fits below a 29" high table, can join with other 25" high, 18" or 23" deep storage units along the panel.
- Can serve as an additional worksurface or an ad-hoc guest seating with optional cushion.
- Two lockable doors
- LP chassis and door fronts (specify LP finish)
- 1" top (specify LP or HP finish); metal handles, powder coated aluminum or anodized aluminum legs. Anodized aluminum leg upcharge \$74.

PRODUCT CODE	FINISH GROUP		SIZE/INCHES			D	WEIGHT LBS	VOL FT <sup>3</sup>
	LP	HP	H	W	D			
L2BRT25L2D30	1208	1324	1079	30	19	69	7.81	
L2BRT25L2D36	1304	1442	1175	36	19	78	9.38	
L2BRT25L2D42	1369	1529	1246	42	19	90	10.94	
L2BRT25L2D3024	1382	1537	1252	30	24	75	10.42	
L2BRT25L2D3624	1499	1682	1370	36	24	84	12.50	
L2BRT25L2D4224	1610	1772	1444	42	24	96	14.58	

**L2BRT25BFxxL • 25" Box/File Pedestal**

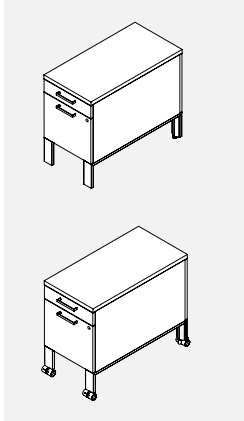

- Fits below a 29" high table.
- Can join with other 25" high storage units of corresponding depth to form a spine or slides out on casters to serve as an additional worksurface.
- Floor clearance allows for access to panel floor raceway duplex outlets; units on levelers accommodate installation of an optional Cable Basket to manage cords and data cables under storage spine.
- One box drawer, one file drawer (holds letter, legal and A4 suspended file folders except 18" pedestals).
- Optional Cable Basket suspends off storage unit's bottom and manages cables along the horizontal plane. (NO CASTER models only)
- Fits under 30" worksurface table beams as is.
- LP chassis and drawer fronts (specify LP finish) 1" top (specify LP or HP finish); metal handles, powder coated aluminum or anodized aluminum legs specify 5/16x2" levelers or 40mm white/grey, locking casters
- Anodized aluminum leg upcharge \$74.
- Pedestal with cushion will not fit under beam.
- Black injection moulded pencil tray included.
- Optional e-lock available in the vertical position. Please specify V - Vertical and add \$304 list.

PRODUCT CODE	FINISH GROUP		SIZE/INCHES			D	WEIGHT LBS	VOL FT <sup>3</sup>
	LP	HP	H	W	D			
<b>Levelers</b>								
L2BRT25BF18L	1118	1187	967	15.5	18	69	3.89	
L2BRT25BF24L	1297	1366	1113	15.5	24	74	5.02	
L2BRT25BF30L	1410	1500	1222	15.5	30	82	6.15	
<b>Casters</b>								
L2BRT25BF18C	1208	1277	1040	15.5	18	69	3.89	
L2BRT25BF24C	1388	1456	1186	15.5	24	74	5.02	
L2BRT25BF30C	1500	1590	1295	15.5	30	82	6.15	

**L2BRTTW50xxL/R • Storage Tower With Coat Storage**

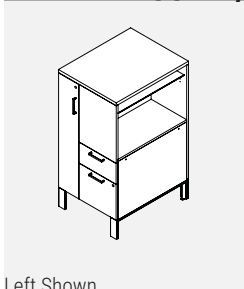

Left Shown

- Provides storage and privacy at the end of a table
- Box+file drawers; open compartment with adjustable shelf (50" high); coat storage with hinged door.
- Specify Left or Right handed.
- Capable of supporting worksurface on one side (built-in threaded inserts to secure dedicated worksurface-supporting beam).
- Open side storage compartment internal height: 19.6".
- Optional Cable Basket suspends off storage unit's bottom and manages cables along the horizontal plane.
- LP chassis (specify LP finish), 1" top (specify LP or HP finish); metal handles; powder coated aluminum or anodized aluminum legs (specify paint finish).
- Anodized aluminum leg upcharge \$74.
- Black injection moulded pencil tray included.
- Optional e-lock available in the vertical position for the box, file drawer. Please specify V - Vertical and add \$304 list.
- Optional e-lock available in the horizontal position for the wardrobe. Please specify HR - Horizontal Right or HL - Horizontal Left and add \$284 list.

PRODUCT CODE	FINISH GROUP		SIZE/INCHES			D	WEIGHT LBS	VOL FT <sup>3</sup>
	LP	HP	H	W	D			
L2BRTTW5024L	2440	2596	2115	24	24	142	16.66	
L2BRTTW5024R	2440	2596	2115	24	24	142	16.66	
L2BRTTW5030L	2710	2865	2334	24	30	163	20.83	
L2BRTTW5030R	2710	2865	2334	24	30	163	20.83	

**L2BRTTW66xxL/R • Storage Tower With Coat Storage**

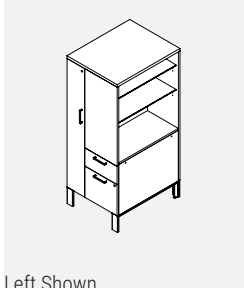

Left Shown

- Provides storage and privacy at the end of a table
- Box+file drawers; open compartment (66" high); coat storage with hinged door and 2 shelves.
- Specify Left or Right handed.
- Capable of supporting worksurface on one side (built-in threaded inserts to secure dedicated worksurface-supporting beam).
- Open side storage compartment internal height: 35.6".
- Optional Cable Basket suspends off storage unit's bottom and manages cables along the horizontal plane.
- LP chassis (specify LP finish), 1" top (specify LP or HP finish); metal handles; powder coated aluminum or anodized aluminum legs (specify paint finish).
- Anodized aluminum leg upcharge \$74.
- Black injection moulded pencil tray included.
- Optional e-lock available in the vertical position for the box, file drawer. Please specify V - Vertical and add \$304 list.
- Optional e-lock available in the horizontal position for the wardrobe. Please specify HR - Horizontal Right or HL - Horizontal Left and add \$284 list.

PRODUCT CODE	FINISH GROUP		SIZE/INCHES			D	WEIGHT LBS	VOL FT <sup>3</sup>
	LP	HP	H	W	D			
L2BRTTW6624L	3173	3375	2750	24	24	170	22	
L2BRTTW6624R	3173	3375	2750	24	24	170	22	
L2BRTTW6630L	3523	3723	3033	24	30	195	27.5	
L2BRTTW6630R	3523	3723	3033	24	30	195	27.5	



**L2BRTC • Cushion**

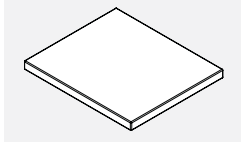

- Optional seat cushion may be added to any storage component.

PRODUCT CODE	SIZE/INCHES			WEIGHT VOL	
	H	W	D	LBS	FT <sup>3</sup>
L2BRTC	1.25	15.5	18	1	0.41

PRODUCT CODE	PRICE									
	GR1	GR2	GR3	GR4	GR5	GR6	GR7	GR8	GR9	GR10
L2BRTC	257	306	340	387	454	518	582	643	707	776

**L2BRPX3MA25xx • 25"-High System 3 Panel**

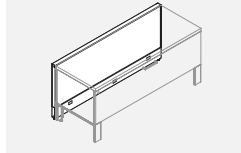

- 25" high System 3 panel facilitates seamless transition from a panel-based, enclosed office to an open one. It can be connected to a cluster of panels on one side and continue with power / data spine distribution into collaborative areas.
- 25" high System 3 panel also enables creation of a storage-based spine with full 8-wire, 4-circuit power and data capacity.

PRODUCT CODE	PRICE			SIZE/INCHES			WEIGHT VOL		
	GR1	GR2	OPT	H	W	D	LBS	FT <sup>3</sup>	
L2BRPX3MA2530	609	638	666	543	543	2.5	5.00	1.09	
L2BRPX3MA2536	663	720	757	617	617	2.5	6.00	1.30	
L2BRPX3MA2542	720	777	816	665	665	2.5	7.00	1.52	

**L2BRPX3GMA25xx • 25"-High System 3 Panel**

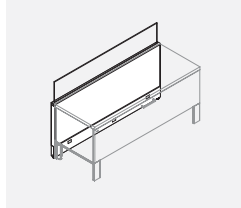

- 25" high System 3 panel facilitates seamless transition from a panel-based, enclosed office to an open one. It can be connected to a cluster of panels on one side and continue with power / data spine distribution into collaborative areas.
- 25" high System 3 panel also enables creation of a storage-based spine with full 8-wire, 4-circuit power and data capacity.
- B3 panel Top trim option provided with embedded, frame-less glass pane rising 8" above the top of the panel. For instance, when installed on 42" high B3 panel, overall height will be 50" high.
- There is 1.25" gap between two adjacent glass panes.
- Glass shipped separately, Allen key to set the glass pane plumb is provided with each panel.
- 5mm tempered glass, acid etched on one side or clear.
- Square corners on glass.
- Integrated adjustable brackets and extruded aluminum trim.
- Cannot be retrofit on-site.

PRODUCT CODE	PRICE			SIZE/INCHES			WEIGHT VOL		
	GR1	GR2	OPT	H	W	D	LBS	FT <sup>3</sup>	
L2BRPX3GMA2530	1193	1221	1284	1046	1046	2.5	5.00	1.09	
L2BRPX3GMA2536	1254	1311	1376	1121	1121	2.5	6.00	1.30	
L2BRPX3GMA2542	1331	1386	1456	1186	1186	2.5	7.00	1.52	

**L2HH • Hutch With Hinged Doors**

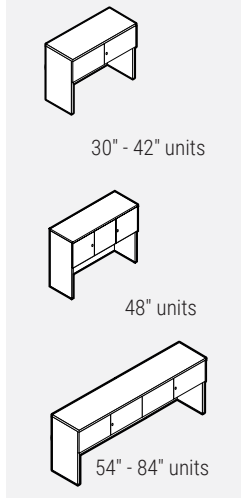

- 30" - 42" units come with one lock.
- 48" - 84" units come with two locks.
- Optional e-lock available in the horizontal position. Please specify HR - Horizontal Right or HL - Horizontal Left for the 48" wide unit and add \$304 list.
- Hutches 48" or longer require two e-locks.

PRODUCT CODE	FINISH		SIZE/INCHES			WEIGHT VOL	
	LP	W	H (LP/B)	W	D	LBS	FT <sup>3</sup>
L2HH30H36	1092	1223	36.81	30	16	138	17
L2HH36H36	1155	1304	36.81	36	16	145	18
L2HH42H36	1252	1436	36.81	42	16	163	19
L2HH48H36	1582	1772	36.81	48	16	180	22
L2HH54H36	1871	2067	36.81	54	16	208	26
L2HH60H36	1910	2154	36.81	60	16	216	29
L2HH66H36	2013	2284	36.81	66	16	233	30
L2HH72H36	2068	2357	36.81	72	16	251	32
L2HH78H36	2186	2553	36.81	78	16	264	46
L2HH84H36	2249	2584	36.81	84	16	277	50
L2HH30H43	1176	1296	43.81	30	16	158	19
L2HH36H43	1215	1364	43.81	36	16	166	20
L2HH42H43	1342	1536	43.81	42	16	175	22
L2HH48H43	1650	1840	43.81	48	16	191	24
L2HH54H43	2114	2311	43.81	54	16	209	31
L2HH60H43	1987	2229	43.81	60	16	227	32
L2HH66H43	2095	2366	43.81	66	16	249	33
L2HH72H43	2196	2487	43.81	72	16	259	36
L2HH78H43	2276	2640	43.81	78	16	272	48
L2HH84H43	2337	2682	43.81	84	16	285	53

**L2HH-A • Hutch With Aluminum Hinged Doors**

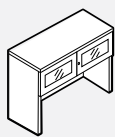

30" - 42" units

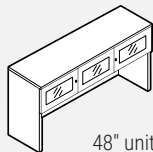

48" units

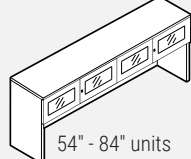

54" - 84" units

- 30" - 42" units come with one lock.
- 48" - 84" units come with two locks.
- Door frame is anodized aluminum.
- Glazing is frosted acrylic.
- Doors standard with no handles.
- E-locks not available for aluminum-framed glass doors.

PRODUCT CODE	FINISH LP	W	SIZE/INCHES			D	WEIGHT LBS	VOL FT <sup>3</sup>
			H (LP/B)	W	D			
L2HH30H36A	1736	1861	36.81	30	16	138	17	
L2HH36H36A	1836	1985	36.81	36	16	145	18	
L2HH42H36A	1955	2099	36.81	42	16	163	19	
L2HH48H36A	2564	2754	36.81	48	16	180	22	
L2HH54H36A	3125	3319	36.81	54	16	208	26	
L2HH60H36A	3206	3448	36.81	60	16	216	29	
L2HH66H36A	3323	3356	36.81	66	16	233	30	
L2HH72H36A	3411	3699	36.81	72	16	251	32	
L2HH78H36A	3530	3896	36.81	78	16	264	46	
L2HH84H36A	3629	3984	36.81	84	16	277	50	
L2HH30H43A	1815	1938	43.81	30	16	158	19	
L2HH36H43A	1899	2047	43.81	36	16	166	20	
L2HH42H43A	2042	2243	43.81	42	16	175	22	
L2HH48H43A	2632	2823	43.81	48	16	191	24	
L2HH54H43A	3200	3399	43.81	54	16	209	31	
L2HH60H43A	3286	3526	43.81	60	16	227	32	
L2HH66H43A	3402	3556	43.81	66	16	249	33	
L2HH72H43A	3544	3837	43.81	72	16	259	36	
L2HH78H43A	3621	3987	43.81	78	16	272	48	
L2HH84H43A	3725	4069	43.81	84	16	285	53	

**L2HO • Open Hutch**

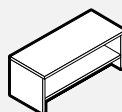

30"-48" 21" high units

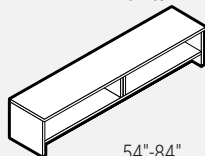

54"-84" 21" high units

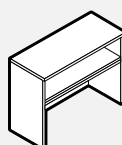

30"-48" units

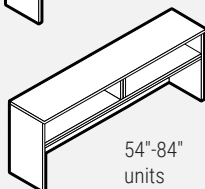

54"-84" units

PRODUCT CODE	FINISH LP	W	SIZE/INCHES			D	WEIGHT LBS	VOL FT <sup>3</sup>
			H (LP/B)	W	D			
L2HO30H21	741	876	20.56	30	16	73	11	
L2HO36H21	806	964	20.56	36	16	81	13	
L2HO42H21	886	1081	20.56	42	16	96	15	
L2HO48H21	1024	1226	20.56	48	16	100	18	
L2HO54H21	1161	1369	20.56	54	16	124	20	
L2HO60H21	1203	1462	20.56	60	16	134	22	
L2HO66H21	1278	1572	20.56	66	16	144	24	
L2HO72H21	1338	1646	20.56	72	16	152	26	
L2HO78H21	1407	1798	20.56	78	16	161	29	
L2HO84H21	1479	1839	20.56	84	16	169	31	
L2HO30H36	829	957	36.81	30	16	91	18	
L2HO36H36	870	981	36.81	36	16	109	19	
L2HO42H36	1027	1241	36.81	42	16	127	22	
L2HO48H36	1097	1301	36.81	48	16	131	24	
L2HO54H36	1251	1490	36.81	54	16	145	29	
L2HO60H36	1367	1624	36.81	60	16	138	31	
L2HO66H36	1446	1737	36.81	66	16	142	33	
L2HO72H36	1554	1867	36.81	72	16	149	36	
L2HO78H36	1587	1976	36.81	78	16	154	46	
L2HO84H36	1661	2026	36.81	84	16	158	50	
L2HO30H43	606	745	43.81	30	16	99	22	
L2HO36H43	662	776	43.81	36	16	108	26	
L2HO42H43	739	932	43.81	42	16	122	31	
L2HO48H43	820	1024	43.81	48	16	127	35	
L2HO54H43	989	1196	43.81	54	16	151	40	
L2HO60H43	1022	1279	43.81	60	16	161	44	
L2HO66H43	1090	1381	43.81	66	16	171	48	
L2HO72H43	1132	1441	43.81	72	16	178	53	
L2HO78H43	1197	1505	43.81	78	16	187	57	
L2HO84H43	1257	1619	43.81	84	16	196	62	

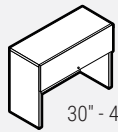
**L2HF • Hutch With Flip-Up Doors**

30" - 48" units

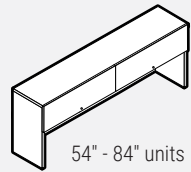

54" - 84" units

- 30" - 48" units come with one lock.
- 54" - 84" units come with two locks.
- Optional e-lock available in the horizontal position. Please specify HR - Horizontal Right and add \$304 list.
- Hutches 48" or longer require two e-locks.

PRODUCT CODE	FINISH		SIZE/INCHES				WEIGHT		VOL FT <sup>3</sup>
	LP	W	H (LP/B)	W	D	LBS			
L2HF30H36	1099	1142	36.81	30	16	142	18		
L2HF36H36	1173	1221	36.81	36	16	146	19		
L2HF42H36	1263	1312	36.81	42	16	158	22		
L2HF48H36	1268	1319	36.81	48	16	180	24		
L2HF54H36	1905	1980	36.81	54	16	182	29		
L2HF60H36	2022	2100	36.81	60	16	220	31		
L2HF66H36	2115	2200	36.81	66	16	253	33		
L2HF72H36	2179	2266	36.81	72	16	259	36		
L2HF78H36	2279	2369	36.81	78	16	264	46		
L2HF84H36	2362	2456	36.81	84	16	275	50		
L2HF30H43	1211	1259	43.81	30	16	150	22		
L2HF36H43	1219	1268	43.81	36	16	154	26		
L2HF42H43	1310	1362	43.81	42	16	166	31		
L2HF48H43	1403	1459	43.81	48	16	188	35		
L2HF54H43	1926	2003	43.81	54	16	194	40		
L2HF60H43	2079	2163	43.81	60	16	232	44		
L2HF66H43	2186	2274	43.81	66	16	265	48		
L2HF72H43	2245	2333	43.81	72	16	271	53		
L2HF78H43	2412	2511	43.81	78	16	276	57		
L2HF84H43	2501	2602	43.81	84	16	287	62		

**L2HHP • Hutch With Laminate Doors and Pigeon Holes**

36" - 42" units



48" units

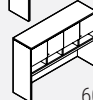

60" - 72" units

- For tackboards, please use LTB21xx.
- 36" - 42" units come with one lock.
- 48" - 72" units come with two locks.
- Optional e-lock available in the horizontal position. Please specify HR - Horizontal Right or HL - Horizontal Left for the 48" wide unit and add \$304 list.
- Hutches 48" or longer require two e-locks.

PRODUCT CODE	FINISH		SIZE/INCHES				WEIGHT		VOL FT <sup>3</sup>
	LP	W	H (LP/B)	W	D	LBS			
L2HHP36	1399	1549	43.81	36	16	145	17		
L2HHP42	1486	1656	43.81	42	16	163	19		
L2HHP48	2007	2201	43.81	48	16	180	22		
L2HHP60	2424	2656	43.81	60	16	216	26		
L2HHP66	2503	2785	43.81	66	16	233	30		
L2HHP72	2607	2893	43.81	72	16	251	32		

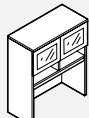
**L2HHP-A • Hutch With Aluminum Hinged Doors and Pigeon Holes**

36" - 42" units

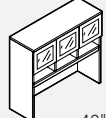

48" units

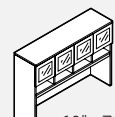

60" - 72" units

- For tackboards, please use LTB21xx.
- 36" - 42" units come with one lock.
- 48" - 72" units come with two locks.
- Door frame is anodized aluminum.
- Glazing is frosted acrylic.
- Doors standard with no handles.
- E-locks not available for aluminum-framed glass doors.

PRODUCT CODE	FINISH		SIZE/INCHES				WEIGHT		VOL FT <sup>3</sup>
	LP	W	H (LP/B)	W	D	LBS			
L2HHP36A	1993	2142	43.81	36	16.8	132	15		
L2HHP42A	2177	2349	43.81	42	16.8	148	17		
L2HHP48A	2918	3115	43.81	48	16.8	164	20		
L2HHP60A	3607	3839	43.81	60	16.8	196	24		
L2HHP66A	3733	4019	43.81	66	16.8	212	27		
L2HHP72A	3887	4176	43.81	72	16.8	228	29		

**L2HSD • Hutch With Sliding Laminate Doors**

• One lock included.

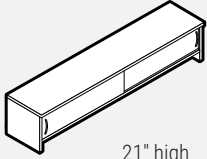

21" high units

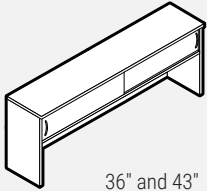

36" and 43" high units

PRODUCT CODE	FINISH LP	W	SIZE/INCHES			WEIGHT LBS	VOL FT <sup>3</sup>
			H (LP/B)	W	D		
L2HSD48H21	1364	1572	20.56	48	16	122	18
L2HSD54H21	1495	1731	20.56	54	16	146	20
L2HSD60H21	1550	1810	20.56	60	16	156	22
L2HSD66H21	1648	1938	20.56	66	16	166	24
L2HSD72H21	1698	1977	20.56	72	16	174	26
L2HSD78H21	1780	2146	20.56	78	16	183	29
L2HSD84H21	1834	2196	20.56	84	16	191	31
L2HSD48H36	1690	1906	36.81	48	16	141	24
L2HSD54H36	1867	2083	36.81	54	16	165	29
L2HSD60H36	1910	2180	36.81	60	16	175	31
L2HSD66H36	2025	2328	36.81	66	16	185	33
L2HSD72H36	2079	2378	36.81	72	16	193	36
L2HSD78H36	2191	2602	36.81	78	16	201	46
L2HSD84H36	2238	2639	36.81	84	16	210	50
L2HSD48H43	1790	2009	43.81	48	16	149	35
L2HSD54H43	1977	2182	43.81	54	16	173	40
L2HSD60H43	2029	2299	43.81	60	16	183	44
L2HSD66H43	2149	2449	43.81	66	16	193	48
L2HSD72H43	2265	2564	43.81	72	16	200	53
L2HSD78H43	2326	2731	43.81	78	16	209	57
L2HSD84H43	2400	2773	43.81	84	16	218	62

**L2HGSD • Hutch With Sliding Glass Doors**

• One lock included.  
• Glass is frosted tempered.

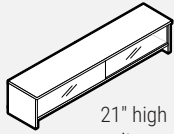

21" high units

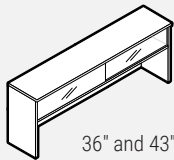

36" and 43" high units

PRODUCT CODE	FINISH LP	W	SIZE/INCHES			WEIGHT LBS	VOL FT <sup>3</sup>
			H (LP/B)	W	D		
L2HGSD48H21	2927	3146	20.56	48	16	139	18
L2HGSD54H21	3087	3330	20.56	54	16	163	20
L2HGSD60H21	3150	3418	20.56	60	16	184	22
L2HGSD66H21	3264	3567	20.56	66	16	194	24
L2HGSD72H21	3341	3663	20.56	72	16	201	26
L2HGSD78H21	3465	3842	20.56	78	16	210	29
L2HGSD84H21	3551	3922	20.56	84	16	219	31
L2HGSD48H36	3108	3330	36.81	48	16	157	24
L2HGSD54H36	3307	3523	36.81	54	16	182	29
L2HGSD60H36	3356	3626	36.81	60	16	202	31
L2HGSD66H36	3483	3787	36.81	66	16	212	33
L2HGSD72H36	3567	3915	36.81	72	16	220	36
L2HGSD78H36	3708	4116	36.81	78	16	229	46
L2HGSD84H36	3807	4181	36.81	84	16	238	50
L2HGSD48H43	3178	3488	43.81	48	16	165	35
L2HGSD54H43	3356	3693	43.81	54	16	189	40
L2HGSD60H43	3433	3795	43.81	60	16	210	44
L2HGSD66H43	3567	3915	43.81	66	16	220	48
L2HGSD72H43	3663	4098	43.81	72	16	228	53
L2HGSD78H43	3803	4271	43.81	78	16	237	57
L2HGSD84H43	3907	4372	43.81	84	16	245	62

**L2DSH • Double-Sided Hutch With Laminate Doors**

• Two locks included.

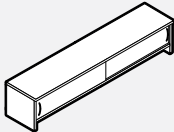

PRODUCT CODE	FINISH LP	W	SIZE/INCHES			WEIGHT LBS	VOL FT <sup>3</sup>
			H (LP/B)	W	D		
L2DSH60H21	1632	1890	20.56	60	16	156	22
L2DSH66H21	1732	2023	20.56	66	16	166	24
L2DSH72H21	1785	2035	20.56	72	16	201	26
L2DSH78H21	1880	2243	20.56	78	16	210	29
L2DSH84H21	1938	2294	20.56	84	16	219	31

**LTB27 • Tackboards for 43"-High Hutches**

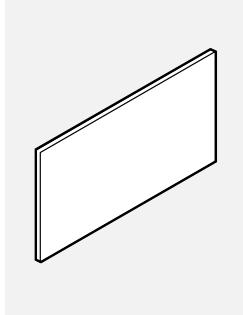

- Provides a tackable surface for notes and memos.
- Velcro for installation is included.
- Tackboards for hutches are 3" shorter than the overall size of the hutch.

PRODUCT CODE	FABRIC		SIZE/INCHES				WEIGHT		VOL FT <sup>3</sup>
	GR1	GR2	H	W	D	LBS			
LTB2727	384	422	27	27	1	7	0.46		
LTB2733	416	457	27	33	1	7	0.57		
LTB2739	449	475	27	39	1	7	0.67		
LTB2745	514	539	27	45	1	8	0.78		
LTB2751	589	606	27	51	1	8	0.88		
LTB2757	658	691	27	57	1	9	0.98		
LTB2763	725	768	27	63	1	9	1.09		
LTB2769	798	843	27	69	1	10	1.19		
LTB2775	892	950	27	75	1	10	1.30		
LTB2781	962	1035	27	81	1	11	1.40		

**LTB21 • Tackboards for 36"-High Hutches**

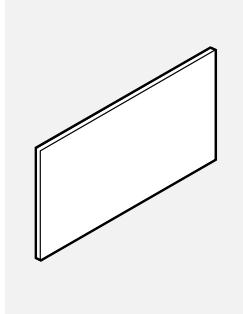

- Provides a tackable surface for notes and memos.
- Velcro for installation is included.
- Tackboards for hutches are 3" shorter than the overall size of the hutch.

PRODUCT CODE	FABRIC		SIZE/INCHES				WEIGHT		VOL FT <sup>3</sup>
	GR1	GR2	H	W	D	LBS			
LTB2127	302	330	21	27	1	4	0.38		
LTB2133	323	355	21	33	1	4	0.42		
LTB2139	352	372	21	39	1	4	0.49		
LTB2145	403	422	21	45	1	5	0.56		
LTB2151	462	475	21	51	1	5	0.63		
LTB2157	514	539	21	57	1	6	0.69		
LTB2163	567	600	21	63	1	6	0.76		
LTB2169	625	659	21	69	1	7	0.83		
LTB2175	697	743	21	75	1	7	0.89		
LTB2181	781	836	21	81	1	8	0.96		

**L2HC • Corner Curved Bookcase**

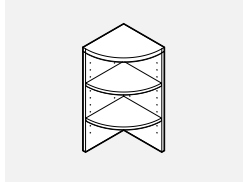

- Shipped knocked down (KD).

PRODUCT CODE	FINISH		SIZE/INCHES				WEIGHT		VOL FT <sup>3</sup>
	LP	W	H (LP/B)	W	D	LBS			
L2HC1637	794	914	36.81	16.87	16.87	57	7		
L2HC1644	843	965	43.81	16.87	16.87	63	8		

**L2HBK • Open Hutch Bookcase**

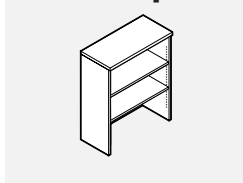

- Shipped knocked down (KD).

PRODUCT CODE	FINISH		SIZE/INCHES				WEIGHT		VOL FT <sup>3</sup>
	LP	W	H (LP/B)	W	D	LBS			
L2HBK303	928	1086	36.81	30	16.875	109	12		
L2HBK363	1005	1191	36.81	36	16.875	123	14		
L2HBK304	1018	1176	43.81	30	16.875	119	13		
L2HBK364	1073	1261	43.81	36	16.875	135	17		

**L2WHO • Wall-Mounted Open Storage**

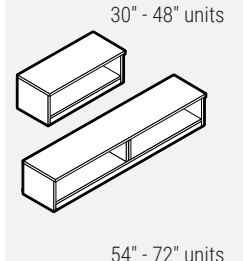

PRODUCT CODE	FINISH		SIZE/INCHES				WEIGHT		VOL FT <sup>3</sup>
	LP	W	H (LP/B)	H(W)	W	D	LBS		
L2WHO30	665	794	16.75	17.18	30	16	69	7	
L2WHO36	711	892	16.75	17.18	36	16	78	8	
L2WHO42	820	998	16.75	17.18	42	16	87	9	
L2WHO48	873	1068	16.75	17.18	48	16	97	10	
L2WHO54	941	1184	16.75	17.18	54	16	106	11	
L2WHO60	1176	1326	16.75	17.18	60	16	117	12	
L2WHO66	1232	1369	16.75	17.18	66	16	125	13	
L2WHO72	1289	1505	16.75	17.18	72	16	139	14	

**L2WHH • Wall-Mounted Hinged Door**

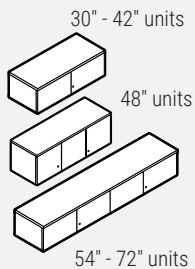

- 30" - 42" units come with one lock.
- 48" - 72" units come with two locks.
- Optional e-lock available in the horizontal position. Please specify HR - Horizontal Right or HL - Horizontal Left for the 48" wide unit and add \$304 list.
- Hitches 48" or longer require two e-locks.

PRODUCT CODE	FINISH LP	W	SIZE / INCHES		W	D	WEIGHT LBS	VOL FT <sup>3</sup>
			H (LP/B)	H (W)				
L2WHH30	900	998	16.75	17.18	30	16	120	7
L2WHH36	965	1081	16.75	17.18	36	16	139	8
L2WHH42	1056	1197	16.75	17.18	42	16	143	9
L2WHH48	1319	1475	16.75	17.18	48	16	145	10
L2WHH54	1563	1739	16.75	17.18	54	16	155	11
L2WHH60	1619	1759	16.75	17.18	60	16	165	12
L2WHH66	1695	1856	16.75	17.18	66	16	175	13
L2WHH72	1769	2003	16.75	17.18	72	16	187	14

**L2WHF • Wall-Mounted Flip-Up Door**

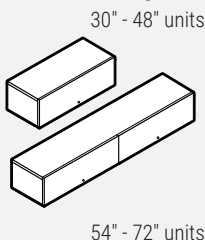

- 30" - 48" units come with one lock.
- 54" - 72" units come with two locks.
- Optional e-lock available in the horizontal position. Please specify HR - Horizontal Right or HL - Horizontal Left add \$304 list.
- Hitches 48" or longer require two e-locks.

PRODUCT CODE	FINISH LP	W	SIZE / INCHES		W	D	WEIGHT LBS	VOL FT <sup>3</sup>
			H (LP/B)	H (W)				
L2WHF30	1005		17.63	17.63	30	16	94	7
L2WHF36	1065		17.63	17.63	36	16	103	8
L2WHF42	1161		17.63	17.63	42	16	113	9
L2WHF48	1219		17.63	17.63	48	16	123	10
L2WHF54	1798		17.63	17.63	54	16	130	11
L2WHF60	1852		17.63	17.63	60	16	141	12
L2WHF66	1961		17.63	17.63	66	16	151	13
L2WHF72	2011		17.63	17.63	72	16	163	14

**L2WHH • Wall-Mounted Unit With Aluminum Doors**

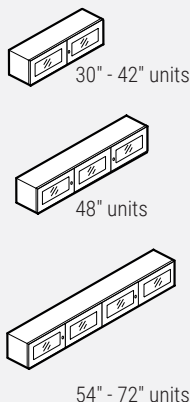

- Horizontal wall rails included.
- 30" - 42" units come with one lock.
- 48" - 72" units come with two locks.
- Door frame is anodized aluminum.
- Glazing is frosted acrylic.
- Doors standard with no handles.
- E-locks not available for aluminum-framed glass doors.

PRODUCT CODE	FINISH LP	W	SIZE / INCHES		W	D	WEIGHT LBS	VOL FT <sup>3</sup>
			H (LP/B)	H (W)				
L2WHH30A	1520	1617	16.75	17.19	30	16	109	6
L2WHH36A	1639	1756	16.75	17.19	36	16	126	7
L2WHH42A	1780	1926	16.75	17.19	42	16	130	8
L2WHH48A	2274	2434	16.75	17.19	48	16	132	9
L2WHH54A	2746	2925	16.75	17.19	54	16	141	10
L2WHH60A	2859	2995	16.75	17.19	60	16	150	11
L2WHH66A	2967	3127	16.75	17.19	66	16	159	12
L2WHH72A	3112	3347	16.75	17.19	72	16	170	13

**L2WSD • Wall-Mounted Unit With Sliding Laminate Doors**

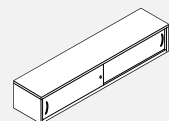

- Wall mounting horizontal rails included.
- One lock included.

PRODUCT CODE	FINISH LP	W	SIZE / INCHES		W	D	WEIGHT LBS	VOL FT <sup>3</sup>
			H (LP/B)	H (W)				
L2WSD36	1334	1501	16.75	17.19	36	16	128	7
L2WSD42	1456	1652	16.75	17.19	42	16	130	8
L2WSD48	1509	1704	16.75	17.19	48	16	132	9
L2WSD54	1669	1907	16.75	17.19	54	16	141	10
L2WSD60	1743	2006	16.75	17.19	60	16	150	11
L2WSD66	1862	2163	16.75	17.19	66	16	159	12
L2WSD72	1916	2234	16.75	17.19	72	16	170	13

**L2WGSD • Wall-Mounted Unit With Sliding Glass Doors**

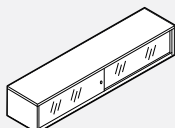

- Wall mounting horizontal rails included.
- Standard recessed chrome pull.
- Lock is included and must be installed at time of manufacturing, please specify key number.
- Frosted tempered glass.

PRODUCT CODE	FINISH LP	W	SIZE / INCHES		W	D	WEIGHT LBS	VOL FT <sup>3</sup>
			H (LP/B)	H (W)				
L2WGSD36	2479	2873	16.75	17.19	36	16	128	7
L2WGSD42	2898	3099	16.75	17.19	42	16	130	8
L2WGSD48	2967	3186	16.75	17.19	48	16	132	9
L2WGSD54	3103	3347	16.75	17.19	54	16	141	10
L2WGSD60	3184	3455	16.75	17.19	60	16	150	11
L2WGSD66	3319	3628	16.75	17.19	66	16	159	12
L2WGSD72	3448	3776	16.75	17.19	72	16	170	13

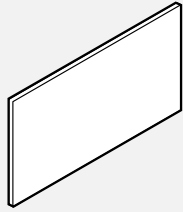
**LTB20 • Tackboards for Wall-Mounted Units**

- Please specify wall rails BHV01 and BHV02 separately, see Boulevard Price List.
- Provides a tackable surface for notes and memos.
- Mounting brackets for installation included.
- Tackboards for Wall-Mounted Unit. Wall Rails (BHV01 and BHV02) must be ordered separately.
- For tackboards longer than 60", please include an additional BHV01 at the center.

PRODUCT CODE	FABRIC		SIZE/INCHES			WEIGHT		VOL FT <sup>3</sup>
	GR1	GR2	H	W	D	LBS		
LTB2030	302	317	19.5	30	1	4	0.38	
LTB2036	323	342	19.5	36	1	4	0.42	
LTB2042	352	378	19.5	42	1	4	0.49	
LTB2048	403	427	19.5	48	1	5	0.56	
LTB2054	462	475	19.5	54	1	5	0.63	
LTB2060	514	539	19.5	60	1	6	0.69	
LTB2066	567	600	19.5	66	1	6	0.76	
LTB2072	625	649	19.5	72	1	7	0.83	
LTB2078	697	723	19.5	78	1	7	0.89	
LTB2084	781	805	19.5	84	1	8	0.96	

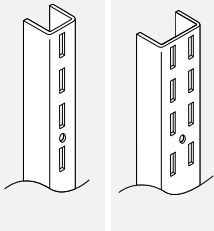
**BHV • Component Wall Adapter - Single and Double**

- Used to attach system components to fixed wall.
- Panel frame finish.
- The vertical wall adapter is a "U" shaped channel with a vertical row of slots with 1" centers.
- The double Component Wall Adapter has a double row of slots with 1" centers.
- Comes in 60" length only.
- Care should be taken to mount adapters only to wall studs using correct fasteners.
- Does not include mounting hardware. Mounting hardware selection to be based on wall material.
- Failure to do this may result in collapse of the unit and subsequent possible personal injury.
- Sold in pairs.

PRODUCT CODE	PRICE	SIZE/INCHES			WEIGHT		VOL FT <sup>3</sup>
		H	W	D	LBS		
BHV01	77	60	0.75	0.5	4	0.009	
BHV02	91	60	1.50	0.5	5	0.026	

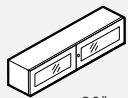
**L2PHH • Boulevard Panel-Mounted Unit With Aluminum Doors**

30" - 42" units

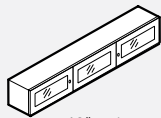

48" unit

- 30" - 42" units comes with one lock
- 48" Unit comes with two locks.
- Door frame is anodized aluminum.
- Glazing is frosted acrylic.
- Doors standard with no handles.
- E-locks not available for aluminum-framed glass doors.

PRODUCT CODE	FINISH		SIZE/INCHES				WEIGHT		VOL FT <sup>3</sup>
	LP	W	H (LP/B)	H (W)	W	D	LBS		
L2PHH30A	1694	1862	16.75	17.19	30	14.75	111	6	
L2PHH36A	1803	2006	16.75	17.19	36	14.75	128	7	
L2PHH42A	1934	2165	16.75	17.19	42	14.75	132	8	
L2PHH48A	2411	2726	16.75	17.19	48	14.75	134	9	

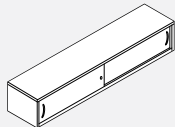
**L2PSD • Boulevard Panel-Mounted Unit With Sliding Laminate Doors**

- Hardware included to mount the unit on the panel.
- One lock included.

PRODUCT CODE	FINISH		SIZE/INCHES				WEIGHT		VOL FT <sup>3</sup>
	LP	W	H (LP/B)	H (W)	W	D	LBS		
L2PSD36	1404	1565	16.75	17.19	36	14.75	123	7	
L2PSD42	1502	1698	16.75	17.19	42	14.75	132	8	
L2PSD48	1539	1733	16.75	17.19	48	14.75	141	9	

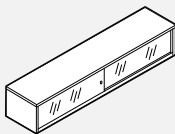
**L2PGSD • Boulevard Panel-Mounted Unit With Sliding Glass Doors**

- Hardware included to mount the unit on the panel.
- One lock included.
- Standard recessed chrome pull.

PRODUCT CODE	FINISH		SIZE/INCHES				WEIGHT		VOL FT <sup>3</sup>
	LP	W	H (LP/B)	H (W)	W	D	LBS		
L2PGSD36	2829	2988	16.75	17.19	36	14.75	123	7	
L2PGSD42	2946	3148	16.75	17.19	42	14.75	132	8	
L2PGSD48	2999	3217	16.75	17.19	48	14.75	141	9	

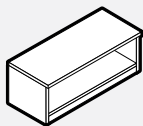
**L2PHO • Boulevard Panel-Mounted Unit, Open Shelf**

- Hardware included to mount the unit on the panel.

PRODUCT CODE	FINISH		SIZE/INCHES				WEIGHT		VOL FT <sup>3</sup>
	LP	W	H (LP/B)	H (W)	W	D	LBS		
L2PHO30	696	799	16.75	17.18	30	14.75	72	7	
L2PHO36	739	902	16.75	17.18	36	14.75	80	8	
L2PHO42	757	977	16.75	17.18	42	14.75	89	9	
L2PHO48	802	1060	16.75	17.18	48	14.75	99	10	

**L2PHH • Boulevard Panel-Mounted Hinged Door Overhead Storage**

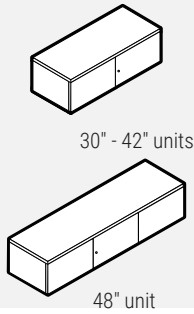

- Hardware included to mount the unit on the panel.
- One lock included.
- Optional e-lock available in the horizontal position. Please specify HR - Horizontal Right or HL - Horizontal Left for the 48" wide unit and add \$304 list.
- Hatches 48" or longer require two e-locks.

PRODUCT CODE	FINISH LP	W	SIZE/INCHES				WEIGHT		VOL FT <sup>3</sup>
			H(LP/B)	H(W)	W	D	LBS		
L2PHH30	1072	1237	16.75	17.18	30	14.75	122	7	
L2PHH36	1128	1328	16.75	17.18	36	14.75	141	8	
L2PHH42	1208	1432	16.75	17.18	42	14.75	145	9	
L2PHH48	1456	1765	16.75	17.18	48	14.75	147	10	

**L2PHF • Boulevard Panel-Mounted Flip-Up Door Overhead Storage**

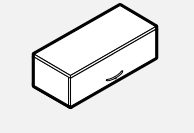

- Hardware included to mount the unit on the panel.
- One lock included.
- Optional e-lock available in the horizontal position. Please specify HR - Horizontal Right and add \$304 list.

PRODUCT CODE	FINISH LP	SIZE/INCHES				WEIGHT		VOL FT <sup>3</sup>
		H(LP)	W	D	LBS			
L2PHF30	1092	17.63	30	16	94	7		
L2PHF36	1145	17.63	36	16	103	8		
L2PHF42	1211	17.63	42	16	113	9		
L2PHF48	1274	17.63	48	16	123	10		

**L2SOHD • Stack-On 2-High Cabinet With Hinged Doors and Adjustable Shelf for 1-High Storage**

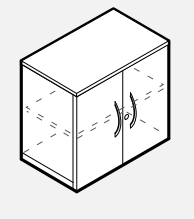

- One lock included.
- Optional e-lock available in the horizontal position. Please specify HR - Horizontal Right and add \$304 list.

PRODUCT CODE	FINISH LP	W	SIZE/INCHES				WEIGHT		VOL FT <sup>3</sup>
			H(LP)	H(W)	W	D	LBS		
<b>one door</b>									
L2SOHDL15	806	895	29.63	29.63	15	16	95	7	
L2SOHDR15	806	895	29.63	29.63	15	16	95	7	
L2SOHDL18	829	916	29.63	29.63	18	16	99	9	
L2SOHDR18	829	916	29.63	29.63	18	16	99	9	
<b>double door</b>									
L2SOHD30	1156	1294	29.63	29.63	30	16	171	11	
L2SOHD36	1290	1456	29.63	29.63	36	16	178	13	

**L2SOALD • Stack-On 2-High Cabinet With Aluminum Hinged Doors and Adjustable Shelf for 1-High Storage**

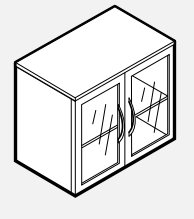

- No lock available for the one door units, one lock included for the double door units.
- Door frame is anodized aluminum.
- Glazing is frosted acrylic.
- Doors standard with no handles.
- E-locks not available for aluminum-framed glass doors.

PRODUCT CODE	FINISH LP	W	SIZE/INCHES				WEIGHT		VOL FT <sup>3</sup>
			H(LP)	H(W)	W	D	LBS		
<b>one door</b>									
L2SOALDL15	1342	1429	29.63	29.63	15	16	88	7	
L2SOALDR15	1342	1429	29.63	29.63	15	16	88	7	
L2SOALDL18	1398	1486	29.63	29.63	18	16	94	9	
L2SOALDR18	1398	1486	29.63	29.63	18	16	94	9	
<b>double door</b>									
L2SOALD30	2266	2403	29.63	29.63	30	16	164	11	
L2SOALD36	2456	2617	29.63	29.63	36	16	172	13	

**L2SOO • Stack-On 2-High Cabinet With Adjustable Shelf for 1-High Storage**

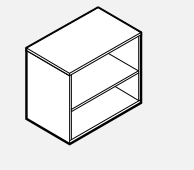

PRODUCT CODE	FINISH LP	W	SIZE/INCHES				WEIGHT		VOL FT <sup>3</sup>
			H(LP)	H(W)	W	D	LBS		
L2SOO15	589	684	29.63	29.63	15	16	61	7	
L2SOO18	603	700	29.63	29.63	18	16	72	8	
L2SOO30	775	923	29.63	29.63	30	16	88	14	
L2SOO36	907	1086	29.63	29.63	36	16	94	19	

**L2SOSD • Stack-On 2-High Cabinet With Sliding Door, Divider and Adjustable Shelves for 1-High Storage**

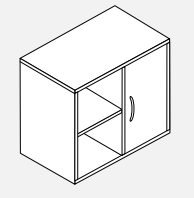

- Includes one sliding door.
- Lock not included.

PRODUCT CODE	FINISH LP	W	SIZE/INCHES				WEIGHT		VOL FT <sup>3</sup>
			H(LP)	H(W)	W	D	LBS		
L2SOSD30	1184	1321	29.63	29.63	30	16	116	14	
L2SOSD36	1394	1561	29.63	29.63	36	16	121	19	

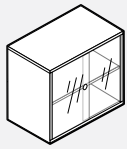

**L2SOGSD • Stack-On 2-High Cabinet With Sliding Glass Doors and Adjustable Shelf for 1-High Storage**

- One lock included.
- Standard recessed chrome pull.
- Glass is frosted tempered.

PRODUCT CODE	FINISH LP	W	SIZE/INCHES				D	WEIGHT LBS	VOL FT <sup>3</sup>
			H(LP)	H(W)	W	D			
L2SOGSD30	2792	2914	29.63	29.63	30	16	116	14	
L2SOGSD36	3056	3204	29.63	29.63	36	16	121	19	

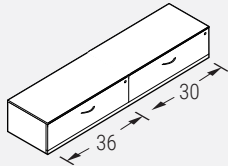
**L2CR1H1H • Credenza, 1-High File/File**

- Two locks included.
- Optional e-lock available in the vertical position. Please specify V - Vertical and add \$304 list.
- Hutches 48" or longer require two e-locks.

PRODUCT CODE	FINISH LP	B	W	SIZE/INCHES				D	WEIGHT LBS	VOL FT <sup>3</sup>
				H(LP/B)	H(W)	W	D			
L2CR1H1H2060	2137	2246	2295	19.94	20.5	60	20	189	22	
L2CR1H1H2066	2238	2358	2411	19.94	20.5	66	20	209	24	
L2CR1H1H2072	2272	2403	2461	19.94	20.5	72	20	246	26	
L2CR1H1H2460	2222	2337	2391	19.94	20.5	60	24	189	22	
L2CR1H1H2466	2328	2451	2509	19.94	20.5	66	24	209	24	
L2CR1H1H2472	2362	2501	2560	19.94	20.5	72	24	246	26	

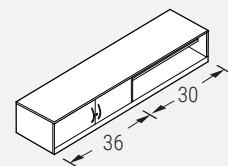
**L2CR2DO • Credenza, 1-High 2 Doors / Open Shelf**

- One lock included.
- One height-adjustable shelf included.
- Optional e-lock available in the horizontal position. Please specify HR - Horizontal Right and add \$304 list.

PRODUCT CODE	FINISH LP	B	W	SIZE/INCHES				D	WEIGHT LBS	VOL FT <sup>3</sup>
				H(LP/B)	H(W)	W	D			
L2CR2DO2060	1829	2030	2141	19.94	20.5	60	20	169	22	
L2CR2DO2066	1910	2133	2250	19.94	20.5	66	20	180	24	
L2CR2DO2072	1993	2238	2369	19.94	20.5	72	20	191	26	
L2CR2DO2460	1903	2114	2225	19.94	20.5	60	24	169	22	
L2CR2DO2466	1987	2218	2342	19.94	20.5	66	24	180	24	
L2CR2DO2472	2076	2326	2463	19.94	20.5	72	24	191	26	

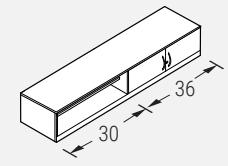
**L2CRO2D • Credenza, 1-High Open Shelf / 2 Doors**

- One lock included.
- One height-adjustable shelf included.
- Optional e-lock available in the horizontal position. Please specify HR - Horizontal Right and add \$304 list.

PRODUCT CODE	FINISH LP	B	W	SIZE/INCHES				D	WEIGHT LBS	VOL FT <sup>3</sup>
				H(LP/B)	H(W)	W	D			
L2CRO2D2060	1829	2030	2141	19.94	20.5	60	20	169	22	
L2CRO2D2066	1910	2133	2250	19.94	20.5	66	20	180	24	
L2CRO2D2072	1993	2238	2369	19.94	20.5	72	20	191	26	
L2CRO2D2460	1903	2114	2225	19.94	20.5	60	24	169	22	
L2CRO2D2466	1987	2218	2342	19.94	20.5	66	24	180	24	
L2CRO2D2472	2076	2326	2463	19.94	20.5	72	24	191	26	

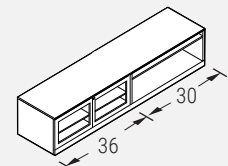
**L2CR2ADO • Credenza, 2 Aluminum Doors / 1-High Open Shelf**

- One lock included.
- One height-adjustable shelf included.
- Door frame is anodized aluminum.
- Glazing is frosted acrylic.
- Doors standard with no handles.

PRODUCT CODE	FINISH LP	B	W	SIZE/INCHES				D	WEIGHT LBS	VOL FT <sup>3</sup>
				H(LP/B)	H(W)	W	D			
L2CR2ADO2060	2474	2679	2790	19.94	20.5	60	20	154	20	
L2CR2ADO2066	2610	2833	2953	19.94	20.5	66	20	164	22	
L2CR2ADO2072	2693	2940	3073	19.94	20.5	72	20	174	24	
L2CR2ADO2460	2551	2763	2949	19.94	20.5	60	24	154	20	
L2CR2ADO2466	2687	2921	3046	19.94	20.5	66	24	164	22	
L2CR2ADO2472	2775	3031	3167	19.94	20.5	72	24	174	24	

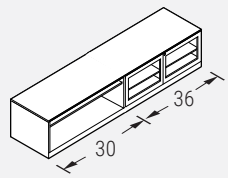
**L2CRO2AD • Credenza, 1-High Open Shelf / 2 Aluminum Doors**

- One lock included.
- One height-adjustable shelf included.
- Door frame is anodized aluminum.
- Glazing is frosted acrylic.
- Doors standard with no handles.

PRODUCT CODE	FINISH LP	B	W	SIZE/INCHES				D	WEIGHT LBS	VOL FT <sup>3</sup>
				H(LP/B)	H(W)	W	D			
L2CRO2AD2060	2474	2679	2790	19.94	20.5	60	20	154	20	
L2CRO2AD2066	2610	2833	2953	19.94	20.5	66	20	164	22	
L2CRO2AD2072	2693	2940	3073	19.94	20.5	72	20	174	24	
L2CRO2AD2460	2551	2763	2949	19.94	20.5	60	24	154	20	
L2CRO2AD2466	2687	2921	3046	19.94	20.5	66	24	164	22	
L2CRO2AD2472	2775	3031	3167	19.94	20.5	72	24	174	24	

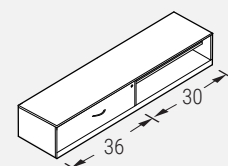
**L2CR1HO • Credenza, 1-High File / Open Shelf**

- One lock included.
- One height-adjustable shelf included.
- Optional e-lock available in the vertical position. Please specify V - Vertical and add \$304 list.

PRODUCT CODE	FINISH LP	B	W	SIZE/INCHES				D	WEIGHT LBS	VOL FT <sup>3</sup>
				H(LP/B)	H(W)	W	D			
L2CR1HO2060	1860	2023	2138	19.94	20.5	60	20	179	22	
L2CR1HO2066	1938	2115	2254	19.94	20.5	66	20	189	24	
L2CR1HO2072	2079	2274	2386	19.94	20.5	72	20	200	26	
L2CR1HO2460	1934	2103	2224	19.94	20.5	60	24	179	22	
L2CR1HO2466	2014	2197	2344	19.94	20.5	66	24	189	24	
L2CR1HO2472	2163	2364	2481	19.94	20.5	72	24	200	26	

**L2CR01H • Credenza, Open Shelf / 1-High File**

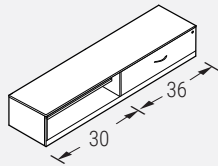

- One lock included.
- One height-adjustable shelf included.
- Optional e-lock available in the vertical position. Please specify V - Vertical and add \$304 list.

PRODUCT CODE	FINISH			SIZE/INCHES				WEIGHT		VOL FT <sup>3</sup>
	LP	B	W	H(LP/B)	H(W)	W	D	LBS		
L2CR01H2060	1860	2023	2138	19.94	20.5	60	20	179	22	
L2CR01H2066	1938	2115	2254	19.94	20.5	66	20	189	24	
L2CR01H2072	2079	2274	2386	19.94	20.5	72	20	200	26	
L2CR01H2460	1934	2103	2224	19.94	20.5	60	24	179	22	
L2CR01H2466	2014	2197	2344	19.94	20.5	66	24	189	24	
L2CR01H2472	2163	2364	2481	19.94	20.5	72	24	200	26	

**L2CR01H • Credenza, 1-High File / 2 Door**

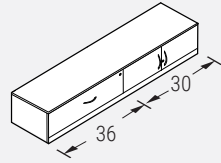

- Two locks included.
- Optional e-lock available in the vertical position for the file drawer. Please specify V - Vertical and add \$304 list.
- Optional e-lock available in the horizontal position. Please specify HR - Horizontal Right and add \$304 list.

PRODUCT CODE	FINISH			SIZE/INCHES				WEIGHT		VOL FT <sup>3</sup>
	LP	B	W	H(LP/B)	H(W)	W	D	LBS		
L2CR1H2D2060	2262	2378	2531	19.94	20.5	60	20	199	22	
L2CR1H2D2066	2284	2416	2733	19.94	20.5	66	20	209	24	
L2CR1H2D2072	2424	2671	2800	19.94	20.5	72	20	220	26	
L2CR1H2D2460	2353	2473	2635	19.94	20.5	60	24	199	22	
L2CR1H2D2466	2374	2515	2841	19.94	20.5	66	24	209	24	
L2CR1H2D2472	2520	2776	2913	19.94	20.5	72	24	220	26	

**L2CR2D1H • Credenza, 2 Doors / 1-High File**

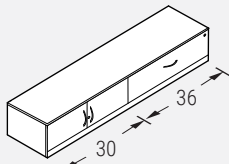

- Two locks included.
- Optional e-lock available in the vertical position for the file drawer. Please specify V - Vertical and add \$304 list.
- Optional e-lock available in the horizontal position. Please specify HR - Horizontal Right and add \$304 list.

PRODUCT CODE	FINISH			SIZE/INCHES				WEIGHT		VOL FT <sup>3</sup>
	LP	B	W	H(LP/B)	H(W)	W	D	LBS		
L2CR2D1H2060	2262	2378	2531	19.94	20.5	60	20	199	22	
L2CR2D1H2066	2284	2416	2733	19.94	20.5	66	20	209	24	
L2CR2D1H2072	2424	2671	2800	19.94	20.5	72	20	220	26	
L2CR2D1H2460	2353	2473	2635	19.94	20.5	60	24	199	22	
L2CR2D1H2466	2374	2515	2841	19.94	20.5	66	24	209	24	
L2CR2D1H2472	2520	2776	2913	19.94	20.5	72	24	220	26	

**L2CR1H2AD • Credenza, 1-High File / 2 Aluminum Doors**

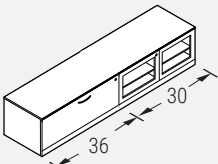

- Two locks included.
- One height-adjustable shelf included.
- Door frame is anodized aluminum.
- Glazing is frosted acrylic.
- Doors standard with no handles.
- Optional e-lock available in the vertical position. Please specify V - Vertical and add \$304 list.
- E-locks not available for aluminum-framed glass doors.

PRODUCT CODE	FINISH			SIZE/INCHES				WEIGHT		VOL FT <sup>3</sup>
	LP	B	W	H(LP/B)	H(W)	W	D	LBS		
L2CR1H2AD2060	2915	3031	3188	19.94	20.5	60	20	181	20	
L2CR1H2AD2066	2988	3121	3444	19.94	20.5	66	20	190	22	
L2CR1H2AD2072	3131	3378	3512	19.94	20.5	72	20	200	24	
L2CR1H2AD2460	3005	3127	3292	19.94	20.5	60	24	181	20	
L2CR1H2AD2466	3080	3221	3556	19.94	20.5	66	24	190	22	
L2CR1H2AD2472	3227	3487	3623	19.94	20.5	72	24	200	24	

**L2CR2AD1H • Credenza, 2 Aluminum Doors / 1-High File**

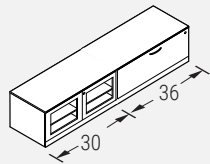

- Two locks included.
- One height-adjustable shelf included.
- Door frame is anodized aluminum.
- Glazing is frosted acrylic.
- Doors standard with no handles.
- Optional e-lock available in the vertical position. Please specify V - Vertical and add \$304 list.
- E-locks not available for aluminum-framed glass doors.

PRODUCT CODE	FINISH			SIZE/INCHES				WEIGHT		VOL FT <sup>3</sup>
	LP	B	W	H(LP/B)	H(W)	W	D	LBS		
L2CR2AD1H2060	2915	3031	3188	19.94	20.5	60	20	181	20	
L2CR2AD1H2066	2988	3121	3444	19.94	20.5	66	20	190	22	
L2CR2AD1H2072	3131	3378	3512	19.94	20.5	72	20	200	24	
L2CR2AD1H2460	3005	3127	3292	19.94	20.5	60	24	181	20	
L2CR2AD1H2466	3080	3221	3556	19.94	20.5	66	24	190	22	
L2CR2AD1H2472	3227	3487	3623	19.94	20.5	72	24	200	24	

**L2DSCR1H • Double-Sided 1-High Credenza Lateral**

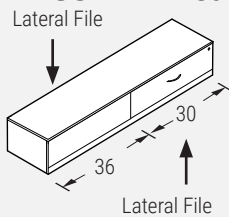

- Two locks included.
- Optional e-lock available in the vertical position. Please specify V - Vertical and add \$304 list.
- Credenzas require two e-locks.

PRODUCT CODE	FINISH			SIZE/INCHES				WEIGHT		VOL FT <sup>3</sup>
	LP	B	W	H(LP/B)	H(W)	W	D	LBS		
L2DSCR1H2060	2519	2640	2727	19.94	20.5	60	20	196	22	
L2DSCR1H2066	2598	2731	2841	19.94	20.5	66	20	206	24	
L2DSCR1H2072	2677	2823	2958	19.94	20.5	72	20	217	26	
L2DSCR1H2460	2618	2746	2837	19.94	20.5	60	24	196	22	
L2DSCR1H2466	2700	2840	2957	19.94	20.5	66	24	206	24	
L2DSCR1H2472	2784	2935	3078	19.94	20.5	72	24	217	26	

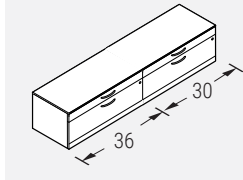
**L2CRBFBF • Credenza, Box/File / Box/File**

- Two locks included.
- Optional e-lock available in the vertical position. Please specify V - Vertical and add \$304 list.
- Credenzas require two e-locks.

PRODUCT CODE	FINISH LP	B	W	SIZE/INCHES				WEIGHT LBS	VOL FT <sup>3</sup>
				H (LP/B)	H (W)	W	D		
L2CRBFBF2060	2902	3010	3062	19.94	20.5	60	20	218	20
L2CRBFBF2066	3015	3139	3193	19.94	20.5	66	20	228	22
L2CRBFBF2072	3066	3200	3258	19.94	20.5	72	20	239	24
L2CRBFBF2460	2988	3103	3158	19.94	20.5	60	24	218	20
L2CRBFBF2466	3108	3235	3292	19.94	20.5	66	24	228	22
L2CRBFBF2472	3158	3298	3358	19.94	20.5	72	24	239	24

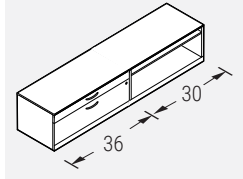
**L2CRBFO • Credenza, Box/File / Open**

- One lock included.
- One height-adjustable shelf included.
- Optional e-lock available in the vertical position. Please specify V - Vertical and add \$304 list.

PRODUCT CODE	FINISH LP	B	W	SIZE/INCHES				WEIGHT LBS	VOL FT <sup>3</sup>
				H (LP/B)	H (W)	W	D		
L2CRBFO2060	2252	2418	2537	19.94	20.5	60	20	202	20
L2CRBFO2066	2347	2525	2666	19.94	20.5	66	20	220	22
L2CRBFO2072	2489	2687	2801	19.94	20.5	72	20	254	24
L2CRBFO2460	2343	2515	2639	19.94	20.5	60	24	202	20
L2CRBFO2466	2440	2639	2774	19.94	20.5	66	24	220	22
L2CRBFO2472	2587	2794	2913	19.94	20.5	72	24	254	24

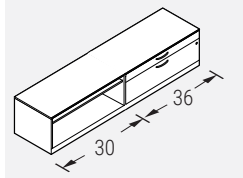
**L2CROBF • Credenza, Open / Box/File**

- One lock included.
- One height-adjustable shelf included.
- Optional e-lock available in the vertical position. Please specify V - Vertical and add \$304 list.

PRODUCT CODE	FINISH LP	B	W	SIZE/INCHES				WEIGHT LBS	VOL FT <sup>3</sup>
				H (LP/B)	H (W)	W	D		
L2CROBF2060	2252	2418	2537	19.94	20.5	60	20	202	20
L2CROBF2066	2347	2525	2666	19.94	20.5	66	20	220	22
L2CROBF2072	2489	2687	2801	19.94	20.5	72	20	254	24
L2CROBF2460	2343	2515	2639	19.94	20.5	60	24	202	20
L2CROBF2466	2440	2639	2774	19.94	20.5	66	24	220	22
L2CROBF2472	2587	2794	2913	19.94	20.5	72	24	254	24

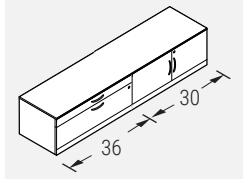
**L2CRBF • Credenza, Box/File / 2 Doors**

- Two locks included.
- One height-adjustable shelf included.
- Optional e-lock available in the vertical position for the file drawer. Please specify V - Vertical and add \$304 list.
- Optional e-lock available in the horizontal position. Please specify HR - Horizontal Right and add \$304 list.

PRODUCT CODE	FINISH LP	B	W	SIZE/INCHES				WEIGHT LBS	VOL FT <sup>3</sup>
				H (LP/B)	H (W)	W	D		
L2CRBF2D2060	2662	2778	2936	19.94	20.5	60	20	214	20
L2CRBF2D2066	2698	2830	3154	19.94	20.5	66	20	224	22
L2CRBF2D2072	2840	3087	3221	19.94	20.5	72	20	235	24
L2CRBF2D2460	2770	2889	3051	19.94	20.5	60	24	214	20
L2CRBF2D2466	2806	2945	3280	19.94	20.5	66	24	224	22
L2CRBF2D2472	2954	3211	3351	19.94	20.5	72	24	235	24

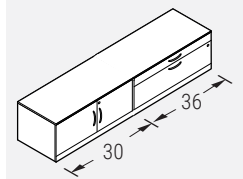
**L2CR2DBF • Credenza, 2 Doors / Box/File**

- Two locks included.
- One height-adjustable shelf included.
- Optional e-lock available in the vertical position for the file drawer. Please specify V - Vertical and add \$304 list.
- Optional e-lock available in the horizontal position. Please specify HR - Horizontal Right and add \$304 list.

PRODUCT CODE	FINISH LP	B	W	SIZE/INCHES				WEIGHT LBS	VOL FT <sup>3</sup>
				H (LP/B)	H (W)	W	D		
L2CR2DBF2060	2662	2778	2936	19.94	20.5	60	20	214	20
L2CR2DBF2066	2698	2830	3154	19.94	20.5	66	20	224	22
L2CR2DBF2072	2840	3087	3221	19.94	20.5	72	20	235	24
L2CR2DBF2460	2770	2889	3051	19.94	20.5	60	24	214	20
L2CR2DBF2466	2806	2945	3280	19.94	20.5	66	24	224	22
L2CR2DBF2472	2954	3211	3351	19.94	20.5	72	24	235	24

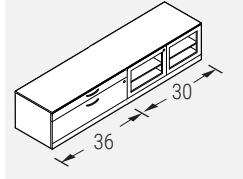
**L2CRBF2AD • Credenza, Box/File / 2 Aluminum Door**

- Two locks included.
- One height-adjustable shelf included.
- Door frame is anodized aluminum.
- Glazing is frosted acrylic.
- Doors standard with no handles.
- Optional e-lock available in the vertical position. Please specify V - Vertical and add \$304 list.
- E-locks not available for aluminum-framed glass doors.

PRODUCT CODE	FINISH LP	B	W	SIZE/INCHES				WEIGHT LBS	VOL FT <sup>3</sup>
				H (LP/B)	H (W)	W	D		
L2CRBF2AD2060	3282	3396	3555	19.94	20.5	60	20	214	20
L2CRBF2AD2066	3368	3503	3825	19.94	20.5	66	20	224	22
L2CRBF2AD2072	3512	3758	3892	19.94	20.5	72	20	235	24
L2CRBF2AD2460	3412	3530	3696	19.94	20.5	60	24	214	20
L2CRBF2AD2466	3504	3642	3979	19.94	20.5	66	24	224	22
L2CRBF2AD2472	3652	3908	4048	19.94	20.5	72	24	235	24

**L2CR2ADBF • Credenza, 2 Aluminum Doors / Box/File**

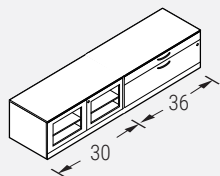

- Two locks included.
- One height-adjustable shelf included.
- Door frame is anodized aluminum.
- Glazing is frosted acrylic.
- Doors standard with no handles.
- Optional e-lock available in the vertical position. Please specify V - Vertical and add \$304 list.
- E-locks not available for aluminum-framed glass doors.

PRODUCT CODE	FINISH			SIZE / INCHES				WEIGHT		VOL FT <sup>3</sup>
	LP	B	W	H (LP/B)	H (W)	W	D	LBS		
L2CR2ADBF2060	3282	3396	3555	19.94	20.5	60	20	214	20	
L2CR2ADBF2066	3368	3503	3825	19.94	20.5	66	20	224	22	
L2CR2ADBF2072	3512	3758	3892	19.94	20.5	72	20	235	24	
L2CR2ADBF2460	3412	3530	3696	19.94	20.5	60	24	214	20	
L2CR2ADBF2466	3504	3642	3979	19.94	20.5	66	24	224	22	
L2CR2ADBF2472	3652	3908	4048	19.94	20.5	72	24	235	24	

**L2CR2H2D • Credenza, 2-High File / 2 Doors**

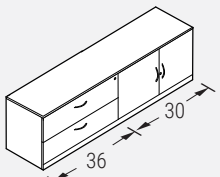

- Two locks included.
- Optional e-lock available in the vertical position for the file drawer. Please specify V - Vertical and add \$304 list.
- Optional e-lock available in the horizontal position. Please specify HR - Horizontal Right and add \$304 list.

PRODUCT CODE	FINISH			SIZE / INCHES				WEIGHT		VOL FT <sup>3</sup>
	LP	B	W	H (LP/B)	H (W)	W	D	LBS		
L2CR2H2D2060	2949	3151	3249	29	29.5	60	20	363	24	
L2CR2H2D2066	3071	3282	3388	29	29.5	66	20	374	26	
L2CR2H2D2072	3200	3394	3534	29	29.5	72	20	396	30	
L2CR2H2D2460	3066	3276	3380	29	29.5	60	24	363	24	
L2CR2H2D2466	3193	3413	3525	29	29.5	66	24	374	26	
L2CR2H2D2472	3328	3526	3675	29	29.5	72	24	396	30	

**L2CR2D2H • Credenza, 2 Doors / 2-High File**

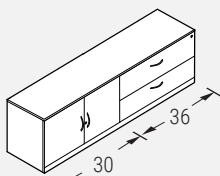

- Two locks included.
- Optional e-lock available in the vertical position for the file drawer. Please specify V - Vertical and add \$304 list.
- Optional e-lock available in the horizontal position. Please specify HR - Horizontal Right and add \$304 list.

PRODUCT CODE	FINISH			SIZE / INCHES				WEIGHT		VOL FT <sup>3</sup>
	LP	B	W	H (LP/B)	H (W)	W	D	LBS		
L2CR2D2H2060	2949	3151	3249	29	29.5	60	20	363	24	
L2CR2D2H2066	3071	3282	3388	29	29.5	66	20	374	26	
L2CR2D2H2072	3200	3394	3534	29	29.5	72	20	396	30	
L2CR2D2H2460	3066	3276	3380	29	29.5	60	24	363	24	
L2CR2D2H2466	3193	3413	3525	29	29.5	66	24	374	26	
L2CR2D2H2472	3328	3526	3675	29	29.5	72	24	396	30	

**L2CR2H2H • Credenza, 2-High File/File**

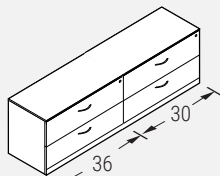

- Two locks included.
- Optional e-lock available in the vertical position. Please specify V - Vertical and add \$304 list.
- Credenzas require two e-locks.

PRODUCT CODE	FINISH			SIZE / INCHES				WEIGHT		VOL FT <sup>3</sup>
	LP	B	W	H (LP/B)	H (W)	W	D	LBS		
L2CR2H2H2060	3420	3539	3666	29	29.5	60	20	385	24	
L2CR2H2H2066	3540	3671	3804	29	29.5	66	20	407	26	
L2CR2H2H2072	3660	3803	3945	29	29.5	72	20	418	30	
L2CR2H2H2460	3556	3679	3812	29	29.5	60	24	385	24	
L2CR2H2H2466	3680	3819	3956	29	29.5	66	24	407	26	
L2CR2H2H2472	3806	3956	4102	29	29.5	72	24	418	30	

**L2CR2D2D • Credenza, 2-High 4 Doors**

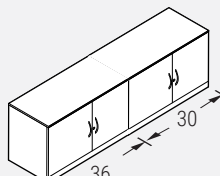

- Two locks included.
- Optional e-lock available in the horizontal position. Please specify HR - Horizontal Right and add \$304 list.
- Credenzas require two e-locks.

PRODUCT CODE	FINISH			SIZE / INCHES				WEIGHT		VOL FT <sup>3</sup>
	LP	B	W	H (LP/B)	H (W)	W	D	LBS		
L2CR2D2D2060	2486	2769	2841	29	29.5	60	20	341	24	
L2CR2D2D2066	2614	2878	2988	29	29.5	66	20	352	26	
L2CR2D2D2072	2747	2989	3131	29	29.5	72	20	363	30	
L2CR2D2D2460	2584	2880	2954	29	29.5	60	24	341	24	
L2CR2D2D2466	2722	2995	3108	29	29.5	66	24	352	26	
L2CR2D2D2472	2859	3109	3255	29	29.5	72	24	363	30	

**L2CR4AD • Credenza, 2-High 4 Aluminum Doors**

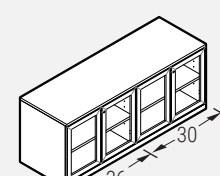

- Two locks included.
- Door frame is anodized aluminum.
- Glazing is frosted acrylic.
- Doors standard with no handles.
- E-lock not available for aluminum-framed glass doors.

PRODUCT CODE	FINISH			SIZE / INCHES				WEIGHT		VOL FT <sup>3</sup>
	LP	B	W	H (LP/B)	H (W)	W	D	LBS		
L2CR4AD2060	4060	4348	4425	29	29.5	60	20	336	24	
L2CR4AD2066	4336	4603	4713	29	29.5	66	20	347	26	
L2CR4AD2072	4616	4861	5008	29	29.5	72	20	358	30	
L2CR4AD2460	4161	4462	4538	29	29.5	60	24	336	24	
L2CR4AD2466	4443	4721	4836	29	29.5	66	24	347	26	
L2CR4AD2472	4729	4983	5133	29	29.5	72	24	358	30	

**LPSTC/LLSTC • Pedestal/Lateral Seat Cushion**

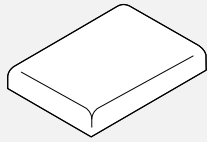

PRODUCT CODE	YRDS	SIZE/INCHES			WEIGHT VOL	
		H	W	D	LBS	FT <sup>3</sup>
LPSTC1518	0.75	2	15.5	18	2	0.34
LPSTC1520	0.75	2	15.5	20	2	0.40
LPSTC1523	0.75	2	15.5	23	3	0.44
LPSTC1524	0.75	2	15.5	24	3	0.46
LPSTC1529	1.00	2	15.5	29	3	0.55
LPSTC1530	1.00	2	15.5	30	3	0.24
LLSTC2030	1.00	2	20	30	5	0.76
LLSTC2036	1.25	2	20	36	6	0.91
LLSTC2230	1.00	2	22	30	6	0.84
LLSTC2236	1.25	2	22	36	7	1.01
LLSTC2430	1.00	2	24	30	6	0.91
LLSTC2436	1.25	2	24	36	7	1.10

PRODUCT CODE	PRICE									
	GR1	GR2	GR3	GR4	GR5	GR6	GR7	GR8	GR9	GR10
LPSTC1518	321	353	392	449	504	560	607	666	723	799
LPSTC1520	328	361	399	458	513	567	616	673	732	807
LPSTC1523	336	367	406	465	519	575	623	679	738	813
LPSTC1524	346	376	414	473	529	582	630	688	746	822
LPSTC1529	425	467	517	594	669	739	807	881	959	1059
LPSTC1530	434	474	525	603	676	748	815	889	966	1067
LLSTC2030	456	498	548	626	700	770	838	913	990	1091
LLSTC2036	544	598	660	758	849	939	1021	1115	1212	1338
LLSTC2230	461	504	555	632	707	785	845	919	997	1098
LLSTC2236	552	71	669	765	856	947	1029	1126	1222	1348
LLSTC2430	467	508	560	637	712	782	817	922	1002	1102
LLSTC2436	562	613	676	774	865	958	1039	1134	1229	1357

**LACWB • Counterweight Balance for use in Licence Storage Units**

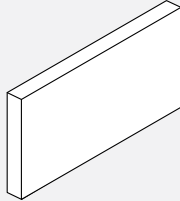

PRODUCT CODE	PRICE	SIZE/INCHES			WEIGHT VOL	
		H	W	D	LBS	FT <sup>3</sup>
LACWB	123	0.5	11.62	11.62	10	0.07

**BHTP01 • Bracket to Connect Licence Towers to Boulevard Panels**

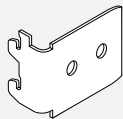

Panel Frame Finish

PRODUCT CODE	PRICE	SIZE/INCHES			WEIGHT VOL	
		H	W	D	LBS	FT <sup>3</sup>
BHTP01	111	2	2.5	1	2	0.05

**L2PO • Pantry Storage**



Left Hand Shown

- The pull out cabinet serves as a multifunction, customizable storage unit that both defines space and enhances privacy in an open plan environment.
- Can be used in conjunction with Licence, FreeFit and Boulevard.
- Internal organization consists of two fixed shelves top and bottom. The two middle shelves are adjustable. Two accessory rails are standard and will accept GC metal accessories
- Interior cabinet shelves and back are standard in Designer White. Cabinet shell, drawer and top can be specified in any standard laminate.
- L2PO-NL/R does not fit binders.
- Only available with FA handle.

**Finish**

While the Pantry Storage cabinet walls, top and pull-out drawer front door and back panel finish can be specified, The internal cabinet back and adjustable shelves are standard white. Please specify the cabinet top and pull-out drawer front finish.

**Options**

- Dual USB outlet kit - please add "USB" at the end of the code. Add \$512 to the list price
- When you specify dual USB outlet the top shelf will come with grey felt surface and grommet which allows for cable passage from the USB outlet (located below the top shelf). A two-prong power cord exits the cabinet through the floor at the back.
- Dry-erase marker board - Choose "DE" option. Please add \$361 to the list price. If specified the Dry-erase marker laminate will be applied to the external surface of the pull-out drawer side wall.

PRODUCT CODE	PRICE LP	SIZE/INCHES				WEIGHT LBS	VOL FT <sup>3</sup>		
		B	W	H(LP/B)	H(W)				
L2PO1224H42NL	2179	2205	2254	41.56	42	12	24	128	7
L2PO1230H42NL	2287	2320	2380	41.56	42	12	30	143	9
L2PO1236H42NL	2395	2433	2505	41.56	42	12	36	157	11
L2PO1824H42NL	2504	2543	2611	41.56	42	18	24	156	11
L2PO1830H42NL	2624	2674	2755	41.56	42	18	30	172	13
L2PO1836H42NL	2745	2803	2900	41.56	42	18	36	187	16
L2PO1224NL	2369	2393	2439	49.56	50	12	24	133	8
L2PO1230NL	2483	2529	2568	49.56	50	12	30	148	10
L2PO1236NL	2599	2665	2700	49.56	50	12	36	162	15
L2PO1824NL	2751	2798	2846	49.56	50	18	24	161	12
L2PO1830NL	2873	2950	2992	49.56	50	18	30	177	15
L2PO1836NL	2998	3101	3136	49.56	50	18	36	192	18
L2PO1224H54NL	2397	2420	2465	53.56	54	12	24	138	9
L2PO1230H54NL	2510	2539	2568	53.56	54	12	30	153	11
L2PO1236H54NL	2624	2660	2699	53.56	54	12	36	167	14
L2PO1824H54NL	2779	2814	2875	53.56	54	18	24	166	14
L2PO1830H54NL	2902	2947	3019	53.56	54	18	30	182	17
L2PO1836H54NL	3027	3078	3163	53.56	54	18	36	197	20
L2PO1224H42NR	2179	2205	2254	41.56	42	12	24	128	7
L2PO1230H42NR	2287	2320	2380	41.56	42	12	30	143	9
L2PO1236H42NR	2395	2433	2505	41.56	42	12	36	157	11
L2PO1824H42NR	2504	2543	2611	41.56	42	18	24	156	11
L2PO1830H42NR	2624	2674	2755	41.56	42	18	30	172	13
L2PO1836H42NR	2745	2803	2900	41.56	42	18	36	187	16
L2PO1224NR	2369	2393	2439	49.56	50	12	24	133	8
L2PO1230NR	2483	2529	2568	49.56	50	12	30	148	10
L2PO1236NR	2599	2665	2700	49.56	50	12	36	162	15
L2PO1824NR	2751	2798	2846	49.56	50	18	24	161	12
L2PO1830NR	2873	2950	2992	49.56	50	18	30	177	15
L2PO1836NR	2998	3101	3136	49.56	50	18	36	192	18
L2PO1224H54NR	2397	2420	2465	53.56	54	12	24	138	9
L2PO1230H54NR	2510	2539	2568	53.56	54	12	30	153	11
L2PO1236H54NR	2624	2660	2699	53.56	54	12	36	167	14
L2PO1824H54NR	2779	2814	2875	53.56	54	18	24	166	14
L2PO1830H54NR	2902	2947	3019	53.56	54	18	30	182	17
L2PO1836H54NR	3027	3078	3163	53.56	54	18	36	197	20

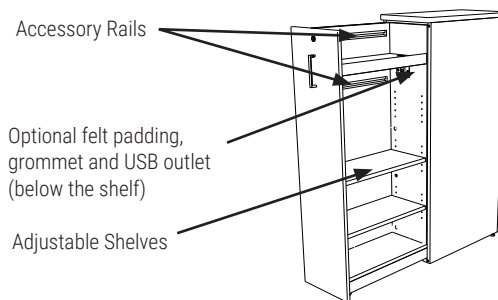
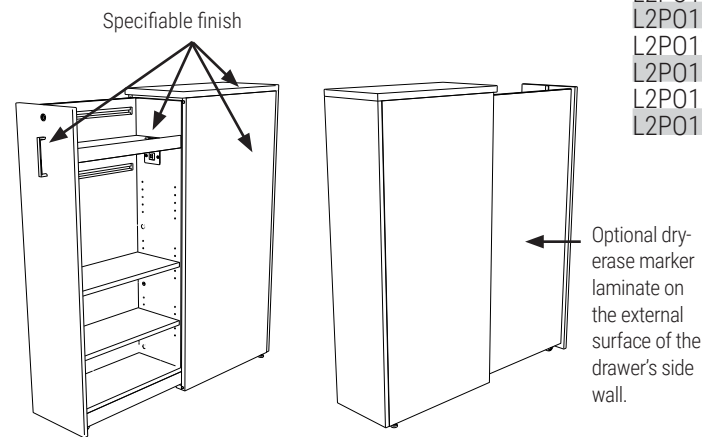

**Integrated Accessory rails**

Two accessory rails (each 18.25" long) are provided to further enhance customization with Teknion metal accessories.

Upper Accessory Rail:

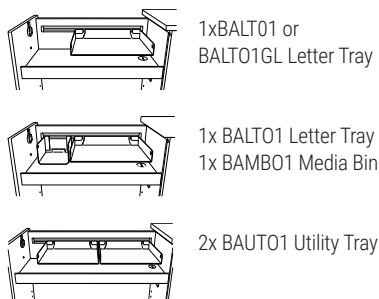

Lower Accessory Rail:

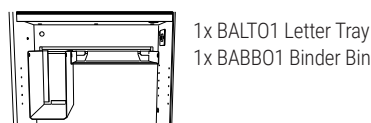
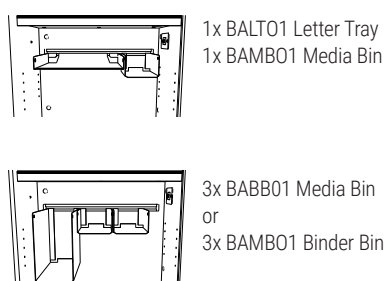

L2PW • Pantry Storage

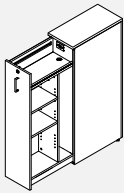

Left Hand Shown

- The pull out cabinet serves as a multifunction, customizable storage unit that both defines space and enhances privacy in an open plan environment.
- Can be used in conjunction with Licence, FreeFit and Boulevard.
- Internal organization consists of two fixed shelves top and bottom. The two middle shelves are adjustable. Two accessory rails are standard and will accept GC metal accessories
- Interior cabinet shelves and back are standard in Designer White. Cabinet shell, drawer and top can be specified in any standard laminate.
- L2P0-NL/R does not fit binders.
- Only available with FA handle.

**Finish**

While the Pantry Storage cabinet walls, top and pull-out drawer front door and back panel finish can be specified, The internal cabinet back and adjustable shelves are standard white. Please specify the cabinet top and pull-out drawer front finish.

**Options**

- Dual USB outlet kit - please add "USB" at the end of the code. Add \$512 to the list price
- When you specify dual USB outlet the top shelf will come with grey felt surface and grommet which allows for cable passage from the USB outlet (located below the top shelf). A two-prong power cord exits the cabinet through the floor at the back.
- Dry-erase marker board - Choose "DE" option. Please add \$361 to the list price. If specified the Dry-erase marker laminate will be applied to the external surface of the pull-out drawer side wall.

PRODUCT CODE	PRICE			SIZE/INCHES				WEIGHT LBS	VOL FT³
	LP	B	W	H(LP/B)	H(W)	W	D		
L2PW1224H42NL	2447	2474	2526	41.56	42	12	24	128	7
L2PW1230H42NL	2559	2592	2654	41.56	42	12	30	143	9
L2PW1236H42NL	2669	2709	2783	41.56	42	12	36	157	11
L2PW1824H42NL	2834	2876	2945	41.56	42	18	24	156	11
L2PW1830H42NL	2958	3009	3093	41.56	42	18	30	172	13
L2PW1836H42NL	3081	3143	3240	41.56	42	18	36	187	16
L2PW1224NL	2667	2691	2738	49.56	50	12	24	133	8
L2PW1230NL	2784	2832	2871	49.56	50	12	30	148	10
L2PW1236NL	2903	2972	3006	49.56	50	12	36	162	15
L2PW1824NL	3117	3165	3215	49.56	50	18	24	161	12
L2PW1830NL	3243	3323	3365	49.56	50	18	30	177	15
L2PW1836NL	3372	3477	3513	49.56	50	18	36	192	18
L2PW1224H54NL	2718	2744	2790	53.56	54	12	24	138	9
L2PW1230H54NL	2835	2865	2895	53.56	54	12	30	153	11
L2PW1236H54NL	2954	2990	3029	53.56	54	12	36	167	14
L2PW1824H54NL	3177	3213	3276	53.56	54	18	24	166	14
L2PW1830H54NL	3305	3351	3425	53.56	54	18	30	182	17
L2PW1836H54NL	3434	3486	3573	53.56	54	18	36	197	20
L2PW1224H42NR	2447	2474	2526	41.56	42	12	24	128	7
L2PW1230H42NR	2559	2592	2654	41.56	42	12	30	143	9
L2PW1236H42NR	2669	2709	2783	41.56	42	12	36	157	11
L2PW1824H42NR	2834	2876	2945	41.56	42	18	24	156	11
L2PW1830H42NR	2958	3009	3093	41.56	42	18	30	172	13
L2PW1836H42NR	3081	3143	3240	41.56	42	18	36	187	16
L2PW1224NR	2667	2691	2738	49.56	50	12	24	133	8
L2PW1230NR	2784	2832	2871	49.56	50	12	30	148	10
L2PW1236NR	2903	2972	3006	49.56	50	12	36	162	15
L2PW1824NR	3117	3165	3215	49.56	50	18	24	161	12
L2PW1830NR	3243	3323	3365	49.56	50	18	30	177	15
L2PW1836NR	3372	3477	3513	49.56	50	18	36	192	18
L2PW1224H54NR	2718	2744	2790	53.56	54	12	24	138	9
L2PW1230H54NR	2835	2865	2895	53.56	54	12	30	153	11
L2PW1236H54NR	2954	2990	3029	53.56	54	12	36	167	14
L2PW1824H54NR	3177	3213	3276	53.56	54	18	24	166	14
L2PW1830H54NR	3305	3351	3425	53.56	54	18	30	182	17
L2PW1836H54NR	3434	3486	3573	53.56	54	18	36	197	20

Specifiable finish

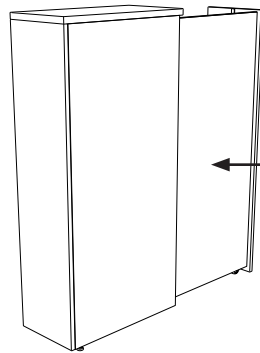
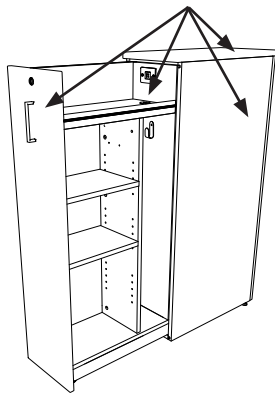

Optional dry-erase marker laminate on the external surface of the drawer's side wall.

Accessory Rails

Optional felt padding, grommet and USB outlet (below the shelf)

Adjustable Shelves

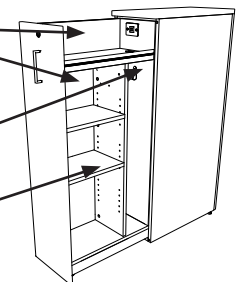

**Integrated Accessory rails**

Two accessory rails (each 18.25" long) are provided to further enhance customization with Teknion metal accessories.

Upper Accessory Rail:

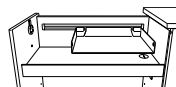

1x BALTO1 or BALTO1GL Letter Tray

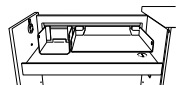

1x BALTO1 Letter Tray  
1x BAMBO1 Media Bin

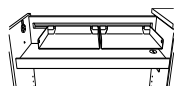

2x BAUTO1 Utility Tray

Lower Accessory Rail:

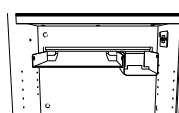

1x BALTO1 Letter Tray  
1x BAMBO1 Media Bin

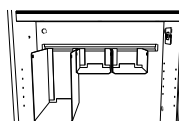

3x BABBO1 Media Bin  
or  
3x BAMBO1 Binder Bin

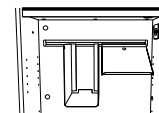

1x BATHO1 Telephone Holder  
1x BABBO1 Binder Bin

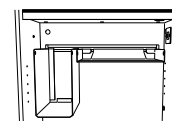

1x BALTO1 Letter Tray  
1x BABBO1 Binder Bin

**TECHNICAL INFORMATION - TABLES**

**Tables**

- All table surfaces are High Pressure Laminate in "B" or "W" thickness.
- All tables have "T" mold edge band, unless otherwise indicated.
- Tables up to and including 96" long are manufactured in one piece, 120" to 192" long are manufactured in two pieces and over 216" are manufactured in three pieces. If wood grain laminate is chosen, the wood grain pattern will not line up.
- Tables in 2 or 3 pieces will have the joining edge finished with PVC edge (0.5mm), hardware will be shipped for assembly.
- Power modules and grommets are not included, they must be specified separately.
- Grommet locations must be specified at the time of order or it will default to "no grommet" option.
- Positions for drop in power and data grommets are intended for use on tops with the following bases: LR, LSQ, LDRUM, TELRS, TELRR, TELBS, TELBR. For any other base, please consult Customer Service Representative.
- Tables are not pre-drilled to accept legs or bases.
- "LTR" Rectangular shape tables with edge B and W have a 1" radius at each corner.
- For table tops with square corners, please add "NR" at the end of the product code, no upcharge required. The "NR" option is available only with the B and W edge profiles.
- "LBT" Boat shape tables are 6" narrower at the ends. The nominal size is identified at the center.
- "LBTB" Boat shape tables with bow ends are 12" narrower at the ends. The nominal size is identified at the center.
- Trapezoid tables can be used in several combinations.

**Bases**

- Available in variety of materials metal, high pressure laminate or low pressure laminate, please refer to specific base in price list
- "LR" Rectangular and "LSQ" square bases come standard with removable access door and cut out on the bottom of the base for pass-thru cables.
- "TELRS / TELBS" square and "TELRR / TELBR" rectangular bases come standard with cut out on the bottom of the base for pass-thru cables. Hinged access doors are optional and must be specified with an "HD" at the end of the code. There will be an upcharge of \$83 to the list price.
- Drum bases are finished in high pressure only and comes with a full bottom and notch at the top. Sand bag included. Access door is not an option.
- Drum, rectangular and square bases are shipped assembled.

**Folding Legs**

- Legs are folded by pressing the lever. Once folded, the legs are held securely by the interlocking springs.
- Includes adjustable levelers offering 12mm (1/2") of adjustment.
- Minimum special sizing for tables is 54" in length and 25" in depth.
- Sold per pair.

**Flip-Top Training Tables**

- "GFT" Rectangular Flip tables with edge B and W edge have straight corners.

**Visual Board**

- Unit offered in high pressure laminate (B) comes with 2 high pressure laminate doors
- Cork board included on one inside door.
- Unit closes with a touch latch mechanism, but no lock option.
- "MG" indicates a magnetic white board.

**TABLES • GUIDELINES FOR ORDERING PRODUCT**

**CODES:** The price list uses a numbering system with meaningful alphanumeric characters to create a simple-to-understand product number. This makes specifying the product much easier and more accurate.

**SPECIFICATION EXAMPLE OF A TABLE UNIT**

**PRODUCT CODE:**           LTS2424  
                                   L = Licence  
                                   T = Table  
                                   S = Square  
                                   2424 = Size: Depth x Width

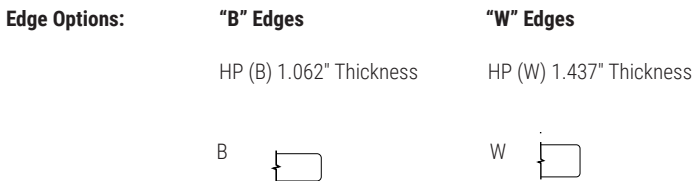



## BASE SPECIFICATION GUIDE (SEE INSTALLATION MANUAL FOR EXAMPLES)

- Tables up to 96" in length require 2 T bases
- Tables 108" to 144" in length require 3 T bases
- Tables 156" to 192" in length require 4 T bases
- Tables 216" to 240" in length require 6 T bases

### FLAT BAR 3-PRONG "TTFL"

BASE SPREAD	TOP WIDTH
18"	24W
22"	30W
24"	36W
30"	42W
36"	48W
36"	54W

### LLT/LLTT W/BULLNOSE ENDS

BASE SPREAD	TOP WIDTH
18"	24W
26"	30W
26"	36W
30"	42W
36"	48W
36"	54W
42"	60W

### TTFLT FLAT BAR "T"

BASE SPREAD	TOP WIDTH
18"	24W
22"	30W
24"	36W
30"	42W
36"	48W
36"	54W

### LD DRUM

BASE SPREAD	ROUND TOP SIZE
18" dia	30" dia
18" dia	36" dia
24" dia	42" dia
24" dia	48" dia
30" dia	54" dia
30" dia	60" dia

### LSQ, TELRS & TELBS SQUARE

BASE SPREAD	TOP SIZE
18"	30x30
18"	36x36
24"	42x42
24"	48x48
30"	54x54
30"	60x60

### LCT CROSS BASE

BASE SPREAD	TOP SIZE
18"	24x24
24"	30x30
24"	36x36
30"	42x42
30"	48x48
36"	54x54
42"	60x60

- 1 Piece Tables up to 96" in length require 2 bases
- Tables 108" to 192" in length require 3 bases
- Tables 216" to 240" in length require 4 bases

### LR, LSQ, TELRS, TELRR, TELBS, TELBR

BASE SPREAD	TOP WIDTH
18"	30
18"	36
24"	42
24"	48
30"	54
30"	60

### LELBA

BASE SPREAD	TOP WIDTH
18"	30
18"	36
24"	42
30"	48
36"	54
36"	60

### TRUMPET 28H

BASE SPREAD	TOP SIZE
18"	24x24
24"	30x30
24"	36x36
30"	42x42
30"	48x48

### FLAT SQUARE

BASE SPREAD	TOP SIZE
18"	24x24
18"	30x30
23"	36x36
23"	42x42
30"	48x48

### FLAT DISC 28H

BASE SPREAD	TOP SIZE
18"	24x24
18"	30x30
24"	36x36
30"	42x42
30"	48x48
36"	54x54

### FLATBAR X

BASE SPREAD	TOP SIZE
18"	24x24
18"	30x30
24"	36x36
24"	42x42
30"	48x48
36"	54x54

### TRUMPET 40.5H

BASE SPREAD	TOP SIZE
18"	24x24
24"	30x30
24"	36x36

### FLAT SQUARE 40.5H

BASE SPREAD	TOP SIZE
18"	24x24
23"	30x30

### FLAT DISC 40.5H

BASE SPREAD	TOP SIZE
18"	24x24
22"	30x30
24"	36x36

### FLATBAR X 40.5H

BASE SPREAD	TOP SIZE
18"	24x24
22"	30x30

### LL4S W/BULLNOSE ENDS

BASE SPREAD	TOP SIZE
18"	24x24
26"	30x30
26"	36x36
26"	42x42
30"	48x48
36"	54x54

### LHC HAT CHANNEL

LHC40	For Table 54" Wide
LHC46	For Table 60" Wide
LHC52	For Table 66" Wide
LHC58	For Table 72" Wide
LHC64	For Table 78" Wide
LHC70	For Table 84" Wide

### LL4S W/BULLNOSE ENDS 40.5H

BASE SPREAD	TOP SIZE
26"	30x30
30"	36x36
36"	42x42

Tops with post legs must be specified with HAT Channels for structural reinforcement.

**GROMMET CUT DIMENSIONS (INCHES)**

**BG5**

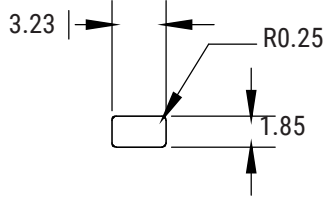
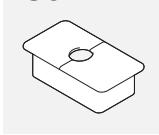

**MSPDM**

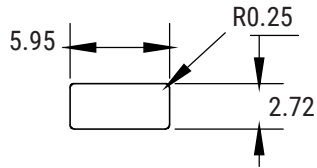
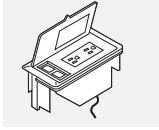

**GAAD**

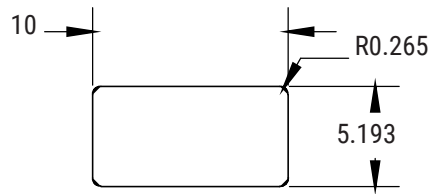
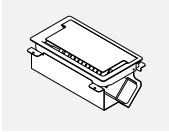

**GCRTMCS4xx**

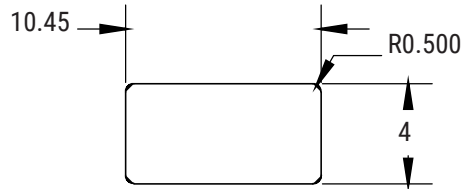
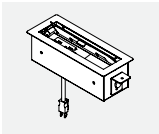

**GCRTMCS6xx**

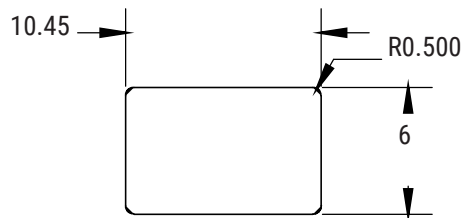
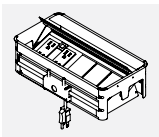

## TABLE DIMENSION CHART AND GROMMET LOCATION

LELBA - Elliptical Base

For One Piece Top

LELBA BASE SPREAD	TOP WIDTH
18"	30
18"	36
24"	42
30"	48
36"	54
36"	60

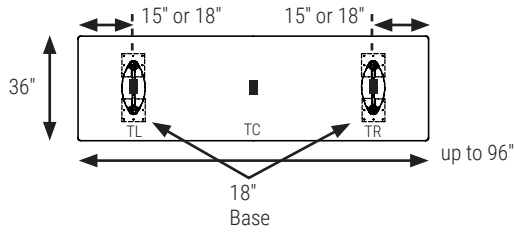

\*15" for table widths between 60" and 72" and 18" for table widths between 78" and 96"

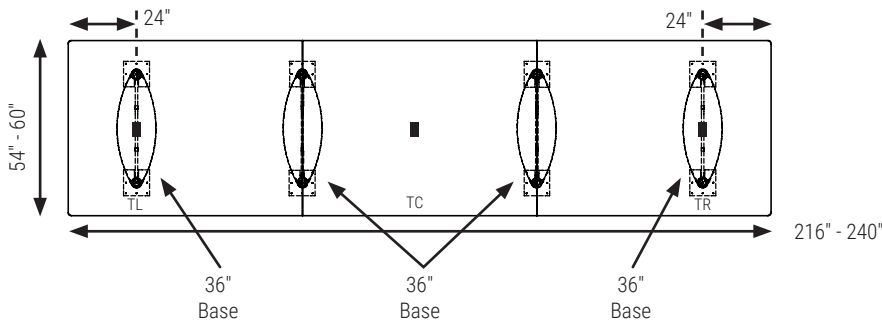
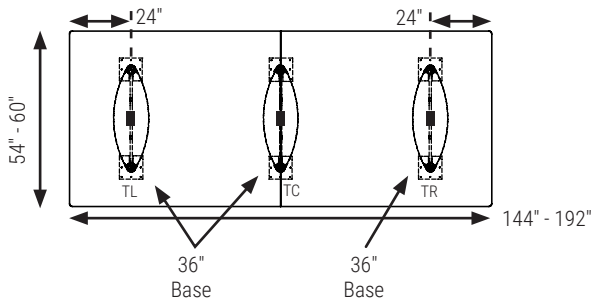
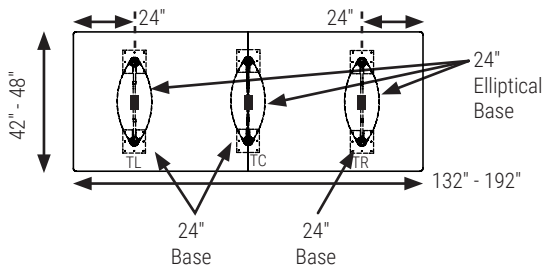
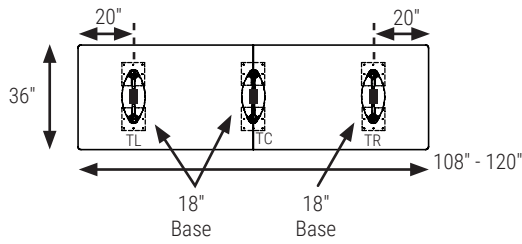

Note: Grommet orientation is perpendicular to the length of table.

**TABLE DIMENSION CHART AND GROMMET LOCATION**

LR - Rectangular Base

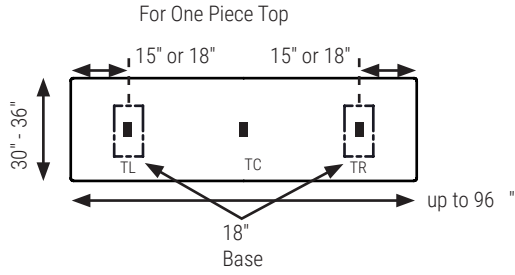

\*15" for table widths between 60" and 72" and 18" for table widths between 78" and 96"

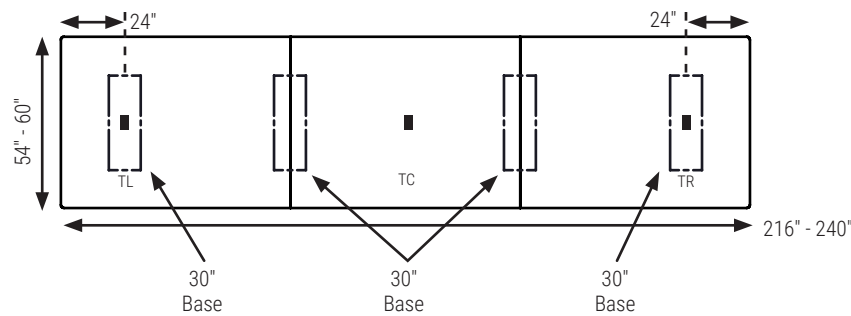
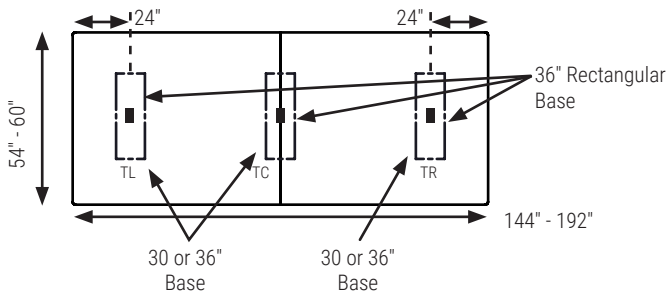
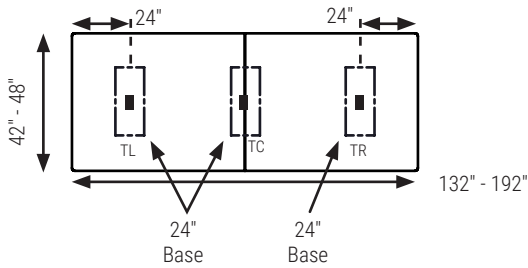
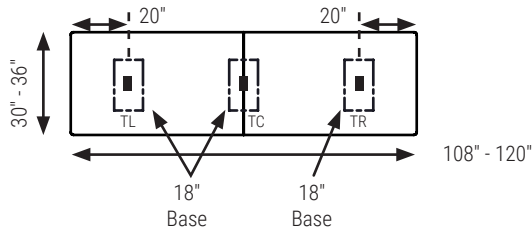

Note: Grommet orientation is perpendicular to the length of table.

TABLE DIMENSION CHART AND GROMMET LOCATION

For One Piece Top

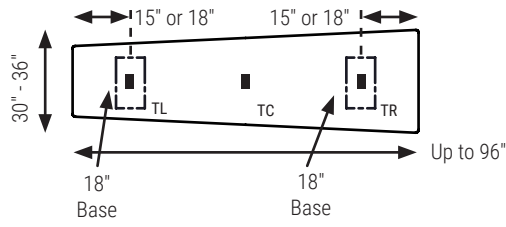

\*15" for table widths between 60" and 72" and 18" for table widths between 78" and 96"

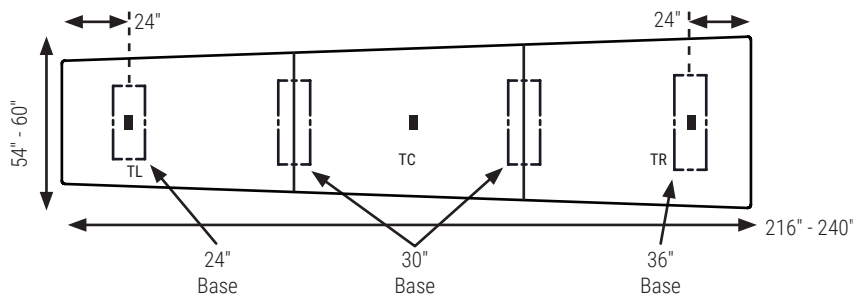
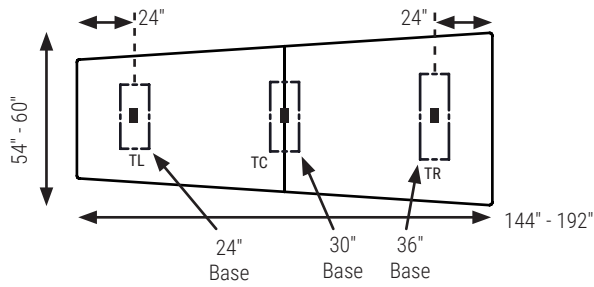
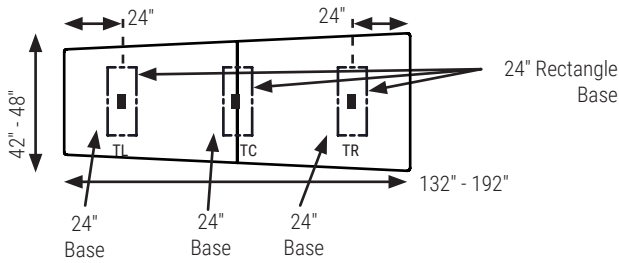
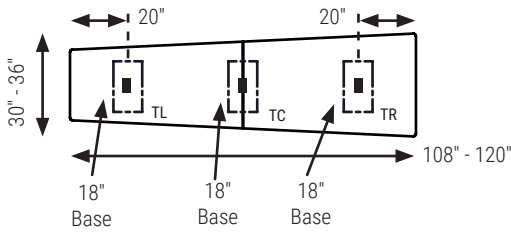

Note: Grommet orientation is perpendicular to the length of table.

**TABLE DIMENSION CHART AND GROMMET LOCATION**

LELBA - Elliptical Base

For One Piece Top

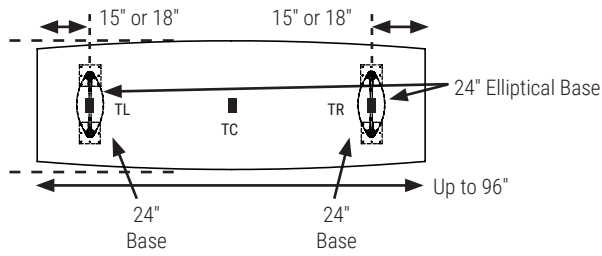

\*15" for table widths between 60" and 72" and 18" for table widths between 78" and 96"

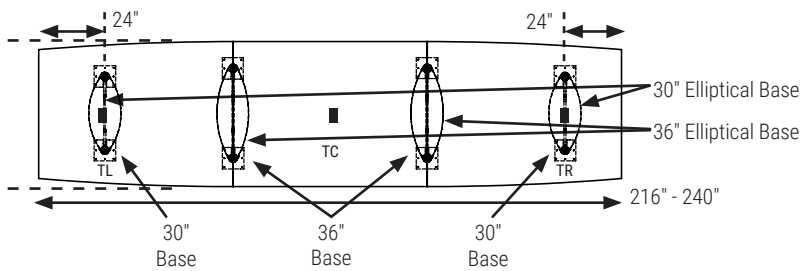
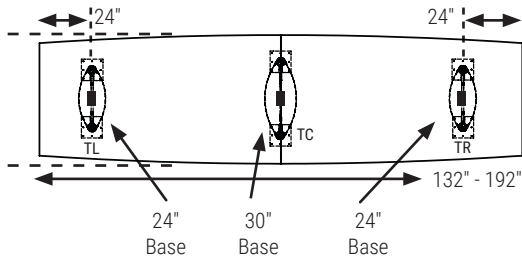
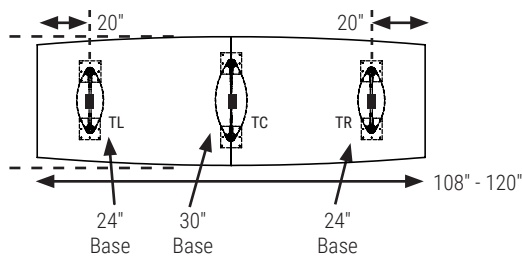

Note: Grommet orientation is perpendicular to the length of table.

## TABLE DIMENSION CHART AND GROMMET LOCATION

LELBA - Rectangular Base

For One Piece Top

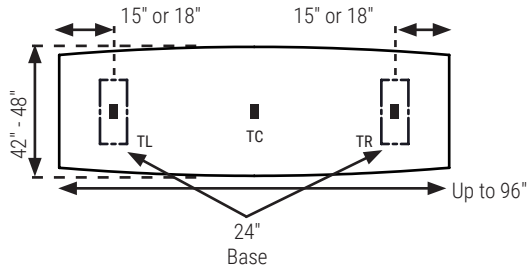

\*15" for table widths between 60" and 72" and 18" for table widths between 78" and 96"

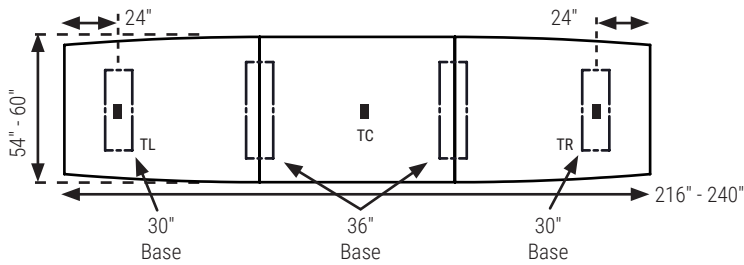
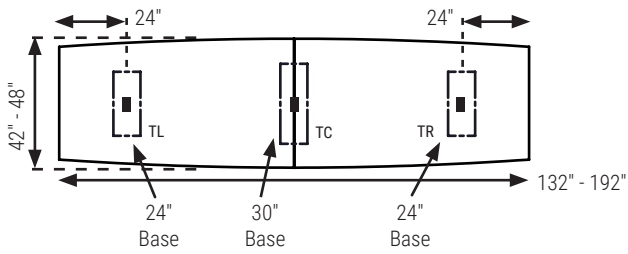
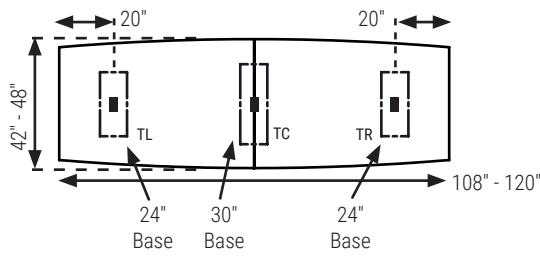

Note: Grommet orientation is perpendicular to the length of table.

**TABLE DIMENSION CHART AND GROMMET LOCATION**

LR - Elliptical Base

For One Piece Top

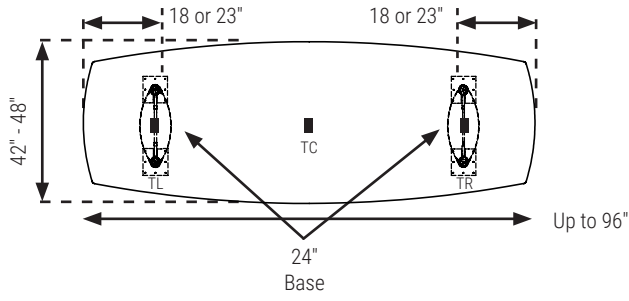

\*18\"/>

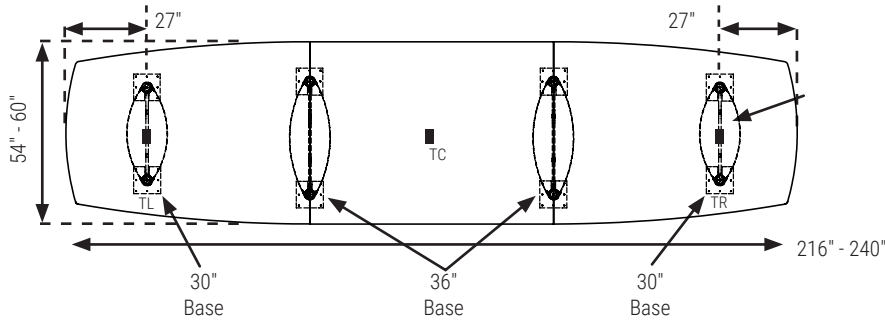
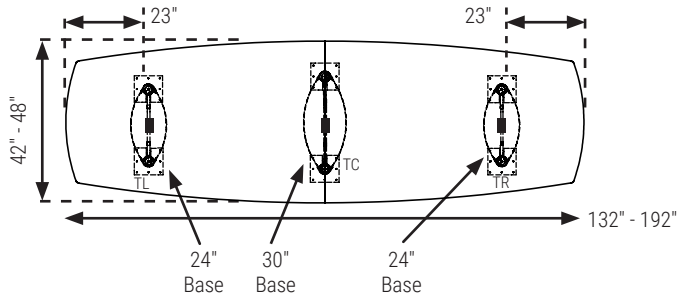
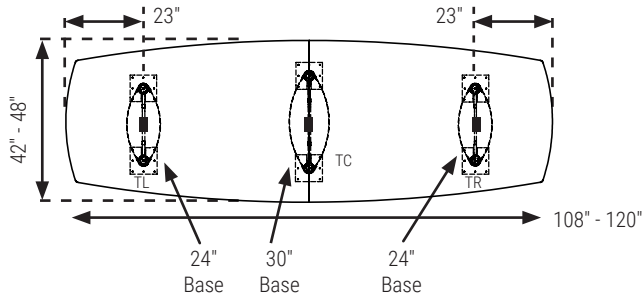

Note: Grommet orientation is perpendicular to the length of table.



**TABLE DIMENSION CHART**

LR - Rectangular Base

For One Piece Top

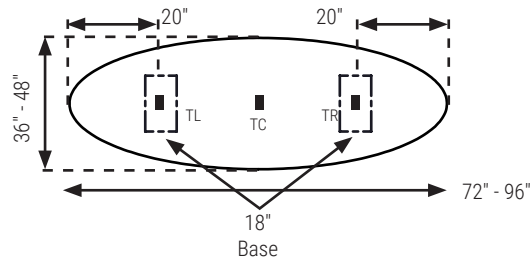

\*15" for table widths between 60" and 72" and 18" for table widths between 78" and 96"

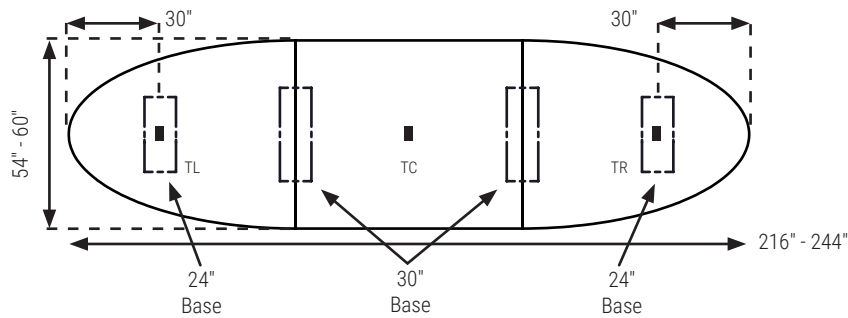
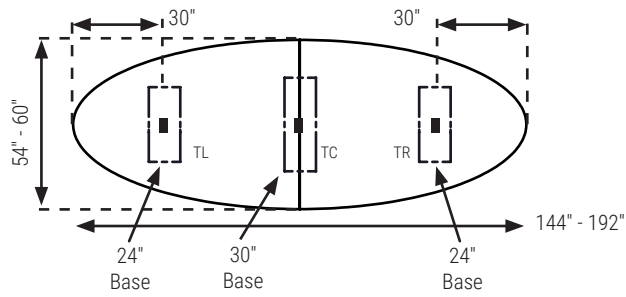
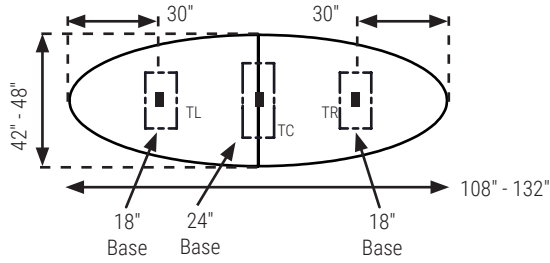

Note: Grommet orientation is perpendicular to the length of table.

**TABLE DIMENSION CHART**

LR - Rectangular Base

For One Piece Top

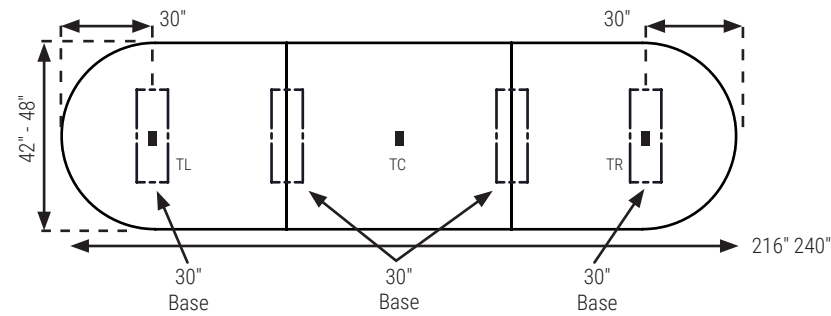
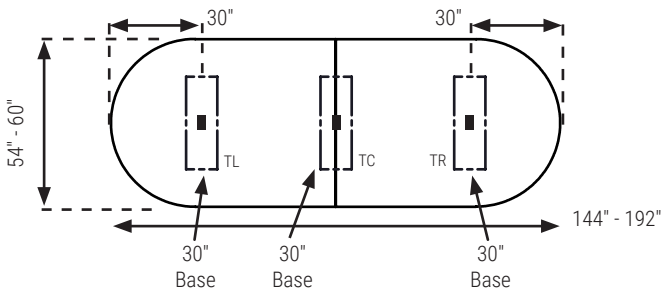
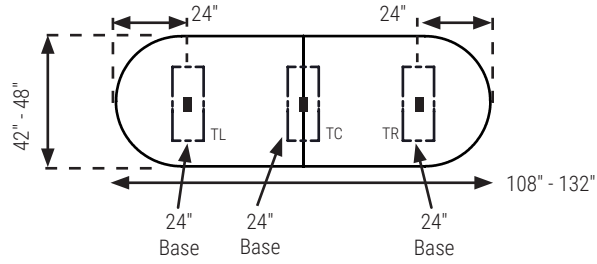
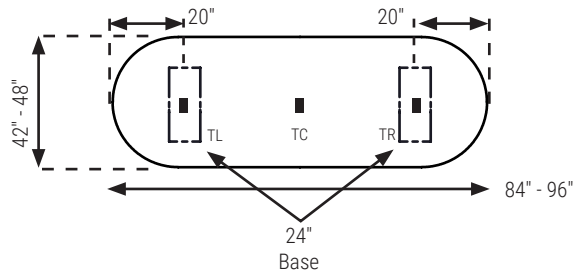

Note: Grommet orientation is perpendicular to the length of table.

**LTS • Square Table Top**

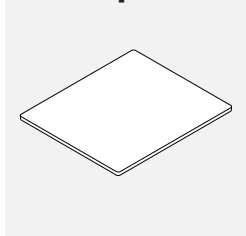

• Tops with Band W thickness have 1" radius corners.

PRODUCT CODE	EDGE		SIZE/INCHES				WEIGHT LBS	VOL FT <sup>3</sup>
	B	W	H(B)	H(W)	W	D		
LTS2424	193	279	1	1.5	24	24	29	3
LTS3030	285	403	1	1.5	30	30	32	3
LTS3636	351	514	1	1.5	36	36	46	4
LTS4242	520	676	1	1.5	42	42	57	6
LTS4848	669	857	1	1.5	48	48	75	7
LTS5454	832	1060	1	1.5	54	54	86	10
LTS6060	1013	1289	1	1.5	60	60	99	12

**L-DIA • Circle Table Top**

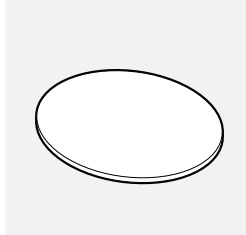

PRODUCT CODE	EDGE		SIZE/INCHES				WEIGHT LBS	VOL FT <sup>3</sup>
	B	W	H(B)	H(W)	W	D		
L24DIA	199	287	1	1.5	24 dia	24 dia	29	3
L30DIA	250	416	1	1.5	30	30	32	3
L36DIA	360	528	1	1.5	36	36	46	4
L42DIA	538	696	1	1.5	42	42	57	6
L48DIA	687	884	1	1.5	48	48	75	7
L54DIA	857	1095	1	1.5	54	54	86	10
L60DIA	1043	1329	1	1.5	60	60	99	12

**LTR • Rectangle Table Top**

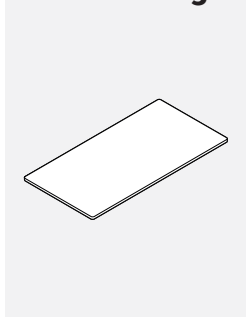

• Tops with B and W thickness have 1" radius corners.

PRODUCT CODE	EDGE		SIZE/INCHES				WEIGHT LBS	VOL FT <sup>3</sup>
	B	W	H(B)	H(W)	W	D		
LTR2430	204	309	1	1.5	30	24	26	2
LTR2436	231	357	1	1.5	36	24	31	2
LTR2442	304	408	1	1.5	42	24	33	3
LTR2448	365	462	1	1.5	48	24	35	3
LTR2454	426	513	1	1.5	54	24	40	3
LTR2460	479	563	1	1.5	60	24	42	4
LTR2466	498	617	1	1.5	66	24	47	4
LTR2472	522	670	1	1.5	72	24	53	4
LTR3036	286	430	1	1.5	36	30	31	2
LTR3042	405	491	1	1.5	42	30	35	2
LTR3048	426	555	1	1.5	48	30	40	3
LTR3054	457	619	1	1.5	54	30	44	3
LTR3060	498	681	1	1.5	60	30	48	3
LTR3066	520	744	1	1.5	66	30	53	3
LTR3072	551	806	1	1.5	72	30	57	3
LTR3078	582	869	1	1.5	78	30	59	4
LTR3084	644	932	1	1.5	84	30	62	4
LTR3096	748	1058	1	1.5	96	30	66	4
LTR3642	464	616	1	1.5	42	36	42	2
LTR3648	524	693	1	1.5	48	36	46	2
LTR3654	587	771	1	1.5	54	36	51	2
LTR3660	646	851	1	1.5	60	36	57	3
LTR3666	707	928	1	1.5	66	36	63	3
LTR3672	767	1005	1	1.5	72	36	68	3
LTR3678	829	1084	1	1.5	78	36	72	3
LTR3684	891	1164	1	1.5	84	36	74	4
LTR3696	1011	1319	1	1.5	96	36	79	4
LTR4248	628	794	1	1.5	48	42	57	3
LTR4254	702	884	1	1.5	54	42	59	3
LTR4260	777	973	1	1.5	60	42	62	3
LTR4266	851	1064	1	1.5	66	42	68	3
LTR4272	921	1154	1	1.5	72	42	73	3
LTR4278	995	1245	1	1.5	78	42	76	3
LTR4284	1069	1334	1	1.5	84	42	78	3
LTR4296	1215	1512	1	1.5	96	42	92	4
LTR4854	795	995	1	1.5	54	48	62	3
LTR4860	878	1097	1	1.5	60	48	66	3
LTR4866	961	1197	1	1.5	66	48	73	3
LTR4872	1043	1299	1	1.5	72	48	79	3
LTR4878	1127	1399	1	1.5	78	48	84	3
LTR4884	1210	1502	1	1.5	84	48	88	4
LTR4896	1376	1704	1	1.5	96	48	110	4

**LTR • Rectangle Table Top 2-Piece**

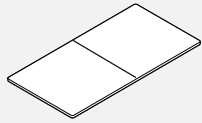

- Tables larger than 192" long are manufactured in 3 pieces.
- Tops with B and W thickness have 1" radius corners.

PRODUCT CODE	EDGE		SIZE/INCHES				WEIGHT LBS	VOL FT <sup>3</sup>
	B	W	H(B)	H(W)	W	D		
LTR36108	1500	1765	1	1.5	108	36	105	4
LTR36120	1650	1945	1	1.5	120	36	114	4
LTR42108	1710	2011	1	1.5	108	42	108	6
LTR42120	1880	2208	1	1.5	120	42	123	6
LTR48108	1909	2238	1	1.5	108	48	110	6
LTR48120	2107	2473	1	1.5	120	48	132	7
LTR48132	2299	2697	1	1.5	132	48	143	7
LTR48144	2332	2737	1	1.5	144	48	158	8
LTR48156	2681	3145	1	1.5	156	48	167	8
LTR48168	2871	3366	1	1.5	168	48	176	9
LTR48180	3218	3773	1	1.5	180	48	189	10
LTR48192	3253	3812	1	1.5	192	48	201	10
LTR54144	2829	3298	1	1.5	144	54	169	10
LTR54168	3253	3794	1	1.5	168	54	187	10
LTR54192	3680	4292	1	1.5	192	54	212	13
LTR54216	4106	4789	1	1.5	216	54	234	18
LTR54240	4533	5287	1	1.5	240	54	259	20
LTR60144	3100	3610	1	1.5	144	60	180	11
LTR60168	3571	4157	1	1.5	168	60	198	13
LTR60192	4041	4703	1	1.5	192	60	223	18
LTR60216	4512	5251	1	1.5	216	60	245	22
LTR60240	4981	5800	1	1.5	240	60	270	24

**LTRB • Rectangle Table Top With Bow Ends**

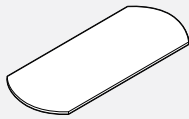

PRODUCT CODE	EDGE		SIZE/INCHES				WEIGHT LBS	VOL FT <sup>3</sup>
	B	W	H(B)	H(W)	W	D		
LTRB4284	1270	1583	1	1.5	84	42	78	3
LTRB4296	1445	1798	1	1.5	96	42	92	4
LTRB4884	1436	1783	1	1.5	84	48	88	4
LTRB4896	1634	2025	1	1.5	96	48	110	4

**LTRB • Rectangle Table Top With Bow Ends 2-Piece**

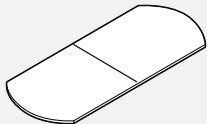

- Tables larger than 192" long are manufactured in 3 pieces.

PRODUCT CODE	EDGE		SIZE/INCHES				WEIGHT LBS	VOL FT <sup>3</sup>
	B	W	H(B)	H(W)	W	D		
LTRB42108	1763	2071	1	1.5	108	42	108	6
LTRB42120	1936	2276	1	1.5	120	42	123	6
LTRB48108	1968	2303	1	1.5	108	48	110	6
LTRB48120	2171	2548	1	1.5	120	48	132	7
LTRB48132	2366	2776	1	1.5	132	48	143	7
LTRB48144	2402	2821	1	1.5	144	48	158	8
LTRB48156	2762	3238	1	1.5	156	48	167	8
LTRB48168	2957	3467	1	1.5	168	48	176	9
LTRB48180	3315	3886	1	1.5	180	48	189	10
LTRB48192	3352	3930	1	1.5	192	48	201	10
LTRB54144	2914	3395	1	1.5	144	54	169	10
LTRB54168	3353	3908	1	1.5	168	54	187	10
LTRB54192	3790	4421	1	1.5	192	54	212	13
LTRB54216	4228	4932	1	1.5	216	54	234	18
LTRB54240	4669	5444	1	1.5	240	54	259	20
LTRB60144	3195	3718	1	1.5	144	60	180	11
LTRB60168	3679	4281	1	1.5	168	60	198	13
LTRB60192	4163	4846	1	1.5	192	60	223	18
LTRB60216	4646	5408	1	1.5	216	60	245	22
LTRB60240	5131	5973	1	1.5	240	60	270	24

**LRT • Racetrack Table Top**



PRODUCT CODE	EDGE		SIZE/INCHES				WEIGHT LBS	VOL FT <sup>3</sup>
	B	W	H(B)	H(W)	W	D		
LRT4284	1270	1583	1	1.5	84	42	78	3
LRT4296	1445	1798	1	1.5	96	42	92	4
LRT4884	1436	1783	1	1.5	84	48	88	4
LRT4896	1634	2025	1	1.5	96	48	110	4

**LRT • Racetrack Table Top 2-Piece**

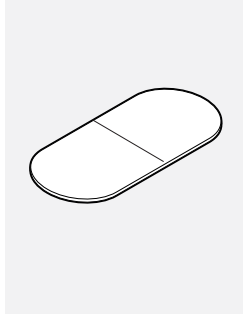

• Tables larger than 192" long are manufactured in 3 pieces.

PRODUCT CODE	EDGE		SIZE / INCHES				WEIGHT LBS	VOL FT <sup>3</sup>
	B	W	H(B)	H(W)	W	D		
LRT42108	1763	2071	1	1.5	108	42	108	6
LRT42120	1936	2276	1	1.5	120	42	123	6
LRT48108	1968	2303	1	1.5	108	48	110	6
LRT48120	2171	2548	1	1.5	120	48	132	7
LRT48132	2366	2776	1	1.5	132	48	143	7
LRT48144	2402	2821	1	1.5	144	48	158	8
LRT48156	2762	3238	1	1.5	156	48	167	8
LRT48168	2957	3467	1	1.5	168	48	176	9
LRT48180	3315	3886	1	1.5	180	48	189	10
LRT48192	3352	3930	1	1.5	192	48	201	10
LRT54144	2914	3395	1	1.5	144	54	169	10
LRT54168	3353	3908	1	1.5	168	54	187	10
LRT54192	3790	4421	1	1.5	192	54	204	10
LRT54216	4228	4932	1	1.5	216	54	226	11
LRT54240	4669	5444	1	1.5	240	54	253	11
LRT60144	3195	3718	1	1.5	144	60	180	11
LRT60168	3679	4281	1	1.5	168	60	198	13
LRT60192	4163	4846	1	1.5	192	60	223	18
LRT60216	4646	5408	1	1.5	216	60	245	22
LRT60240	5131	5973	1	1.5	240	60	270	24

**LO • Oval Table Top**

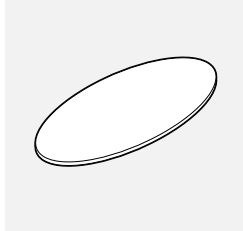

PRODUCT CODE	EDGE		SIZE / INCHES				WEIGHT LBS	VOL FT <sup>3</sup>
	B	W	H(B)	H(W)	W	D		
LO3672	912	1196	1	1.5	72	36	68	3
LO3684	1057	1383	1	1.5	84	36	74	3
LO3696	1203	1569	1	1.5	96	36	79	3
LO4284	1270	1583	1	1.5	84	42	78	3
LO4296	1445	1798	1	1.5	96	42	92	4
LO4884	1436	1783	1	1.5	84	48	88	4
LO4896	1634	2025	1	1.5	96	48	110	4

**LBT • Boat Table Top**

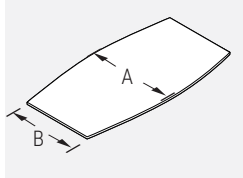

A	B
42	36
48	42

PRODUCT CODE	EDGE		SIZE / INCHES				WEIGHT LBS	VOL FT <sup>3</sup>
	B	W	H(B)	H(W)	W	D		
LBT4284	1270	1583	1	1.5	84	42	78	3
LBT4296	1445	1798	1	1.5	96	42	92	4
LBT4884	1436	1783	1	1.5	84	48	99	4
LBT4896	1634	2025	1	1.5	96	48	110	4

**LBT • Boat Table Top 2-Piece**

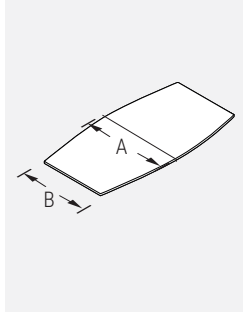

• Tables larger than 192" long are manufactured in 3 pieces.  
• 6" narrower at the ends.

A	B
42	36
48	42
54	48
60	54

PRODUCT CODE	EDGE		SIZE / INCHES				WEIGHT LBS	VOL FT <sup>3</sup>
	B	W	H(B)	H(W)	W	D		
LBT42108	1763	2071	1	1.5	108	42	108	6
LBT42120	1936	2276	1	1.5	120	42	123	6
LBT48108	1968	2303	1	1.5	108	48	110	6
LBT48120	2171	2548	1	1.5	120	48	132	7
LBT48132	2366	2776	1	1.5	132	48	143	7
LBT48144	2402	2821	1	1.5	144	48	158	8
LBT48156	2762	3238	1	1.5	156	48	167	8
LBT48168	2957	3467	1	1.5	168	48	176	9
LBT48180	3315	3886	1	1.5	180	48	189	10
LBT48192	3352	3930	1	1.5	192	48	201	10
LBT54144	2914	3395	1	1.5	144	54	169	10
LBT54168	3353	3908	1	1.5	168	54	187	10
LBT54192	3790	4421	1	1.5	192	54	212	13
LBT54216	4228	4932	1	1.5	216	54	234	18
LBT54240	4669	5444	1	1.5	240	54	259	20
LBT60144	3195	3718	1	1.5	144	60	180	11
LBT60168	3679	4281	1	1.5	168	60	198	13
LBT60192	4163	4846	1	1.5	192	60	223	18
LBT60216	4646	5408	1	1.5	216	60	245	22
LBT60240	5131	5973	1	1.5	240	60	270	24

**LBTB • Boat Table Top With Bow Ends**

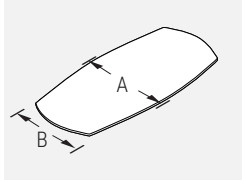

A	B
42	30
48	36

PRODUCT CODE	EDGE		SIZE/INCHES				WEIGHT LBS	VOL FT <sup>3</sup>
	B	W	H(B)	H(W)	W	D		
LBTB4284	1270	1583	1	1.5	84	42	78	3
LBTB4296	1445	1798	1	1.5	96	42	92	4
LBTB4884	1436	1783	1	1.5	84	48	88	4
LBTB4896	1634	2025	1	1.5	96	48	110	4

**LBTB • Boat Table Top With Bow Ends 2-Piece**

• Tables larger than 192" long are manufactured in 3 pieces.

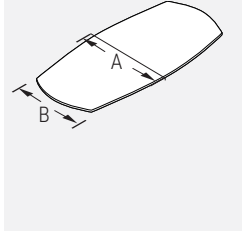

A	B
60	48
54	42
48	36
42	30

PRODUCT CODE	EDGE		SIZE/INCHES				WEIGHT LBS	VOL FT <sup>3</sup>
	B	W	H(B)	H(W)	W	D		
LBTB42108	1763	2071	1	1.5	108	42	108	6
LBTB42120	1936	2276	1	1.5	120	42	123	6
LBTB48108	1968	2303	1	1.5	108	48	110	6
LBTB48120	2171	2548	1	1.5	120	48	132	7
LBTB48132	2366	2776	1	1.5	132	48	143	7
LBTB48144	2402	2821	1	1.5	144	48	158	8
LBTB48156	2762	3238	1	1.5	156	48	167	8
LBTB48168	2957	3467	1	1.5	168	48	176	9
LBTB48180	3315	3886	1	1.5	180	48	189	10
LBTB48192	3352	3930	1	1.5	192	48	204	11
LBTB54144	2914	3395	1	1.5	144	54	176	9
LBTB54168	3353	3908	1	1.5	168	54	187	10
LBTB54192	3790	4421	1	1.5	192	54	212	13
LBTB54216	4228	4932	1	1.5	216	54	234	18
LBTB54240	4669	5444	1	1.5	240	54	259	20
LBTB60144	3195	3718	1	1.5	144	60	180	11
LBTB60168	3679	4281	1	1.5	168	60	198	13
LBTB60192	4163	4846	1	1.5	192	60	223	18
LBTB60216	4646	5408	1	1.5	216	60	245	22
LBTB60240	5131	5973	1	1.5	240	60	270	24

**LTW • Wedge Table Top**

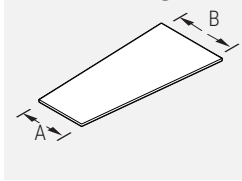

A	B
36	48

PRODUCT CODE	EDGE		SIZE/INCHES				WEIGHT LBS	VOL FT <sup>3</sup>
	B	W	H(B)	H(W)	W	D		
LTW4896	1634	2025	1	1.5	96	48	110	4

**LTW • Wedge Table Top 2-Piece**

• Tables larger than 192" long are manufactured in 3 pieces.

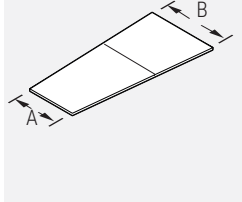

A	B
48	60
42	54
36	48

PRODUCT CODE	EDGE		SIZE/INCHES				WEIGHT LBS	VOL FT <sup>3</sup>
	B	W	H(B)	H(W)	W	D		
LTW48108	1968	2303	1	1.5	108	48	110	6
LTW48120	2171	2548	1	1.5	120	48	132	7
LTW48132	2366	2776	1	1.5	132	48	143	7
LTW48144	2402	2821	1	1.5	144	48	158	8
LTW48156	2762	3238	1	1.5	156	48	167	8
LTW48168	2957	3467	1	1.5	168	48	176	9
LTW48180	3315	3886	1	1.5	180	48	189	10
LTW48192	3352	3930	1	1.5	192	48	201	10
LTW54144	2914	3395	1	1.5	144	54	169	10
LTW54168	3353	3908	1	1.5	168	54	187	10
LTW54192	3790	4421	1	1.5	192	54	212	13
LTW54216	4228	4932	1	1.5	216	54	234	18
LTW54240	4669	5444	1	1.5	240	54	259	20
LTW60144	3195	3718	1	1.5	144	60	180	11
LTW60168	3679	4281	1	1.5	168	60	198	13
LTW60192	4163	4846	1	1.5	192	60	223	18
LTW60216	4646	5408	1	1.5	216	60	245	22
LTW60240	5131	5973	1	1.5	240	60	270	24

LTW \_ \_ - first dash is A and second dash is the length, B is not included in code.

**LTWB • Wedge Table Top With Bow Ends**

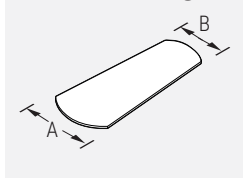

A	B
48	36

PRODUCT CODE	EDGE		H(B)	H(W)	W	D	WEIGHT LBS	VOL FT <sup>3</sup>
	B	W						
LTWB4896	1634	2025	1	1.5	96	48	110	4

**LTWB • Wedge Table Top With Bow Ends 2-Piece**

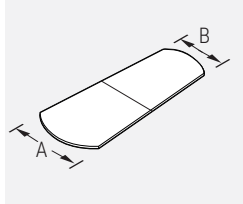

• Tables larger than 192" long are manufactured in 3 pieces.

A	B
48	36
54	42
60	48

PRODUCT CODE	EDGE		H(B)	H(W)	W	D	WEIGHT LBS	VOL FT <sup>3</sup>
	B	W						
LTWB48108	1968	2303	1	1.5	108	48	110	6
LTWB48120	2171	2548	1	1.5	120	48	132	7
LTWB48132	2366	2776	1	1.5	132	48	143	7
LTWB48144	2402	2821	1	1.5	144	48	158	8
LTWB48156	2762	3238	1	1.5	156	48	167	8
LTWB48168	2957	3467	1	1.5	168	48	176	9
LTWB48180	3315	3886	1	1.5	180	48	189	10
LTWB48192	3352	3930	1	1.5	192	48	198	11
LTWB54144	2914	3395	1	1.5	144	54	178	9
LTWB54168	3353	3908	1	1.5	168	54	187	10
LTWB54192	3790	4421	1	1.5	192	54	212	13
LTWB54216	4228	4932	1	1.5	216	54	234	18
LTWB54240	4669	5444	1	1.5	240	54	259	20
LTWB60144	3195	3718	1	1.5	144	60	180	11
LTWB60168	3679	4281	1	1.5	168	60	198	13
LTWB60192	4163	4846	1	1.5	192	60	223	18
LTWB60216	4646	5408	1	1.5	216	60	245	22
LTWB60240	5131	5973	1	1.5	240	60	270	24

**LHM • Halfmoon Table Top**

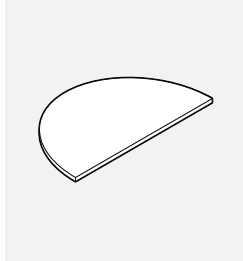

PRODUCT CODE	EDGE		H(B)	H(W)	W	D	WEIGHT LBS	VOL FT <sup>3</sup>
	B	W						
LHM2424	227	331	1	1.5	24	24	29	3
LHM2448	433	547	1	1.5	48	24	35	3
LHM2460	571	671	1	1.5	60	24	42	4
LHM2472	622	795	1	1.5	72	24	53	6
LHM3030	288	479	1	1.5	30	30	32	3
LHM3048	506	659	1	1.5	48	30	40	4
LHM3060	593	808	1	1.5	60	30	48	6
LHM3072	655	960	1	1.5	72	30	57	7

**LTZ • Trapezoid Table Top**

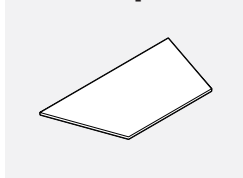

PRODUCT CODE	EDGE		H(B)	H(W)	W	D	WEIGHT LBS	VOL FT <sup>3</sup>
	B	W						
LTZ2460	571	671	1	1.5	60	24	42	4
LTZ2472	622	795	1	1.5	72	24	53	6
LTZ3060	593	808	1	1.5	60	30	48	6
LTZ3072	655	960	1	1.5	72	30	57	7

**LW • Wave Table Top**

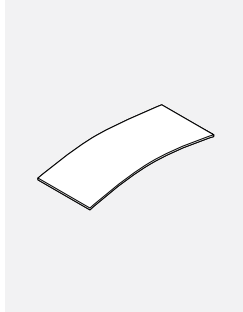

PRODUCT CODE	EDGE		H(B)	H(W)	W	D	WEIGHT LBS	VOL FT <sup>3</sup>
	B	W						
LW2448	433	547	1	1.5	48	24	35	3
LW2460	571	671	1	1.5	60	24	42	4
LW2466	593	734	1	1.5	66	24	47	6
LW2472	622	795	1	1.5	72	24	53	6
LW3060	593	808	1	1.5	60	30	48	6
LW3066	621	883	1	1.5	66	30	53	7
LW3072	655	960	1	1.5	72	30	64	8
LW3660	766	1010	1	1.5	60	36	53	7
LW3666	840	1102	1	1.5	66	36	63	8
LW3672	912	1196	1	1.5	72	36	68	9

**LCT • Cross Base for Table Tops**

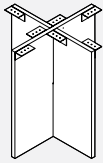

PRODUCT CODE	PRICE	SIZE/INCHES			WEIGHT		VOL FT <sup>3</sup>
		H	W	D	LBS		
LCT18	600	28	18	18	29	6	
LCT24	600	28	24	24	39	4	
LCT30	676	28	30	30	48	6	
LCT36	676	28	36	36	57	8	
LCT42	870	28	42	42	62	9	

**LR • Rectangular Base for Table Tops**

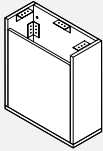

• Short side panel is removable for full wire access.

PRODUCT CODE	PRICE	SIZE/INCHES			WEIGHT		VOL FT <sup>3</sup>
		H	W	D	LBS		
LR18	520	28	18	10	39	3	
LR24	589	28	24	10	46	4	
LR30	649	28	30	10	54	6	
LR36	728	28	36	10	66	8	
LR42	836	28	42	10	83	9	

**LSQ • Square Base for Table Tops**

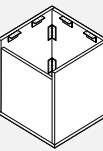

• Short side panel is removable for full wire access.

PRODUCT CODE	PRICE	SIZE/INCHES			WEIGHT		VOL FT <sup>3</sup>
		H	W	D	LBS		
LSQ18	655	28	18	18	50	7	
LSQ24	802	28	24	24	66	11	
LSQ30	957	28	30	30	83	17	

**LDRUM • Drum Base for Table Tops**

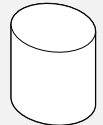

PRODUCT CODE	PRICE	SIZE/INCHES			WEIGHT		VOL FT <sup>3</sup>
		H	W	D	LBS		
LDRUM18	1059	28	18	18	32	8	
LDRUM24	1130	28	24	24	43	11	
LDRUM30	1161	28	30	30	54	14	

**LV • "V" Base for Table Tops**

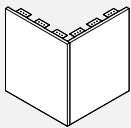

PRODUCT CODE	PRICE	SIZE/INCHES			WEIGHT		VOL FT <sup>3</sup>
		H	W	D	LBS		
LV1818	349	28	18	18	29	3	
LV2424	396	28	24	24	39	4	
LV3030	469	28	30	30	48	6	

**LELBA • Elliptical Base With Aluminum Extrusion**

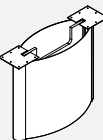

- Laminate side panels are removable for full wire access.
- Standard in metal paint finishes.
- Optional anodized aluminum finish available, please add \$45 list.

PRODUCT CODE	PRICE	SIZE/INCHES			WEIGHT		VOL FT <sup>3</sup>
		H	W	D	LBS		
LELBA18	1396	28	18	9	33	2	
LELBA24	1450	28	24	10	44	2	
LELBA30	1507	28	30	12	55	4	
LELBA36	1570	28	36	13	66	7	
LELBA42	1630	28	42	14	77	9	



**TELRR • Rectangular Panel Base With Anodized Aluminum Radius Corner Detail**

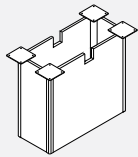

• Single hinged access door is optional. Add "HD" to the end of the code. Add \$108 to list price.

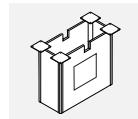

PRODUCT CODE	PRICE	SIZE/INCHES			WEIGHT LBS	VOL FT <sup>3</sup>
		H	W	D		
TELRR18	883	28	18	12	66	7
TELRR24	932	28	24	12	72	9
TELRR30	984	28	30	12	105	11
TELRR36	1036	28	36	12	129	13
TELRR42	1086	28	42	12	129	15

**TELBR • Rectangular Base With Rectangular Anodized Aluminum Corner Detail**

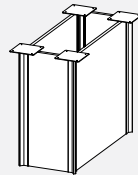

• Single hinged access door is optional. Add "HD" to the end of the code. Add \$108 to list price.

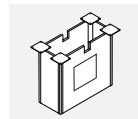

PRODUCT CODE	PRICE	SIZE/INCHES			WEIGHT LBS	VOL FT <sup>3</sup>
		H	W	D		
TELBR18	912	28	18	12	66	7
TELBR24	964	28	24	12	72	9
TELBR30	1014	28	30	12	105	11
TELBR36	1065	28	36	12	129	13
TELBR42	1118	28	42	12	129	15

**TELRS • Square Panel Base With Anodized Aluminum Radius Corner Detail**

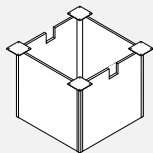

• Single hinged access door is optional. Add "HD" to the end of the code. Add \$108 to list price.

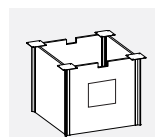

PRODUCT CODE	PRICE	SIZE/INCHES			WEIGHT LBS	VOL FT <sup>3</sup>
		H	W	D		
TELRS18	949	28	18	18	77	7
TELRS24	1045	28	24	24	83	9
TELRS30	1142	28	30	30	117	20
TELRS36	1241	28	36	36	140	24
TELRS42	1339	28	42	42	140	24

**TELBS • Square Base With Rectangular Anodized Aluminum End Detail**

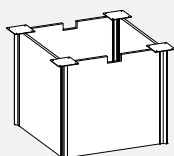

• Single hinged access door is optional. Add "HD" to the end of the code. Add \$108 to list price.

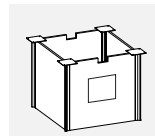

PRODUCT CODE	PRICE	SIZE/INCHES			WEIGHT LBS	VOL FT <sup>3</sup>
		H	W	D		
TELBS18	977	28	18	18	77	7
TELBS24	1092	28	24	24	83	9
TELBS30	1215	28	30	30	117	20
TELBS36	1346	28	36	36	140	24
TELBS42	1486	28	42	42	140	24

**TRUM • Trumpet Column Base**

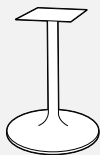

PRODUCT CODE	PRICE		SIZE/INCHES			WEIGHT LBS	VOL FT <sup>3</sup>
	PAINTED	CHROME	H	W	D		
TRUM18	581	705	28	18	18	15	9
TRUM24	663	788	28	24	24	18	13
TRUM30	1078	1203	28	30	30	20	15
TRUM18BH	854	945	40.5	18	18	26	18
TRUM24BH	978	1069	40.5	24	24	29	15

**TTFD • Flat Disk Column Base**

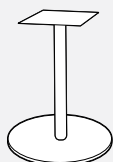

PRODUCT CODE	PRICE		SIZE/INCHES			WEIGHT LBS	VOL FT <sup>3</sup>
	PAINTED	CHROME	H	W	D		
TTFD18	1036	1119	28	18	18	50	9
TTFD22	1119	1203	28	22	22	55	13
TTFD24	1203	1286	28	24	24	66	14
TTFD30	1615	1699	28	30	30	88	15
TTFD36	2320	2487	28	36	36	110	15
TTFD18BH	1268	1350	40.5	18	18	72	11
TTFD22BH	1350	1434	40.5	22	22	77	15
TTFD24BH	1434	1516	40.5	24	24	110	17

**TTSQ • Flat Square Column Base**

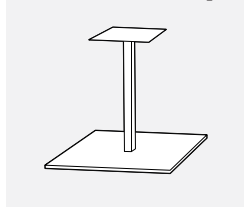

- Plate size: (18" - 30" 11" x 11"), (36" 14" x 14").
- Column size: (18" - 24" 2.1/2"), (30" - 36" 3")

PRODUCT CODE	PRICE		SIZE/INCHES			WEIGHT		VOL FT <sup>3</sup>
	PAINTED	CHROME	H	W	D	LBS		
TTSQ18	1450	1533	28	18	18	50	9	
TTSQ23	1615	1699	28	23	23	61	13	
TTSQ30	2073	2155	28	30	30	88	15	
TTSQ18BH	1684	1766	40.5	18	18	72	11	
TTSQ23BH	1850	1931	40.5	23	23	83	15	

**TTFLTX • Flat Bar "X" Column Base**



- Plate size: (18" - 30" 11" x 11"), (36" 14" x 14").
- Column size: (18" - 24" 2.1/2"), (30" - 36" 3")

PRODUCT CODE	PRICE		SIZE/INCHES			WEIGHT		VOL FT <sup>3</sup>
	PAINTED	CHROME	H	W	D	LBS		
TTFLTX18	1533	1740	28	18	18	15	9	
TTFLTX22	1554	1763	28	22	22	17	11	
TTFLTX24	1575	1781	28	24	24	18	13	
TTFLTX30	1615	1823	28	30	30	20	15	
TTFLTX36	1657	1864	28	36	36	22	24	
TTFLTX18BH	1766	1972	40.5	18	18	26	11	
TTFLTX22BH	1785	1993	40.5	22	22	28	13	
TTFLTX24BH	1850	2014	40.5	24	24	29	15	

**TTFLT • Flat Bar "T" Column Base**

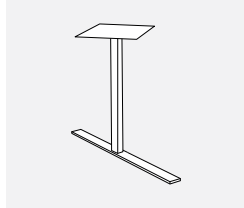

- Plate size: (18" - 30" 11" x 11"), (36" 14" x 14").
- Column size: (18" - 24" 2.1/2"), (30" - 36" 3")

PRODUCT CODE	PRICE		SIZE/INCHES			WEIGHT		VOL FT <sup>3</sup>
	PAINTED	CHROME	H	W	D	LBS		
TTFLT18	1161	1328	28		18	9	2	
TTFLT22	1181	1346	28		22	10	2	
TTFLT24	1203	1369	28		24	11	3	
TTFLT30	1245	1408	28		30	13	3	
TTFLT36	1286	1450	28		36	15	3	

**TTFL3P • Flat Bar 3-Prong Column Base**



- Plate size: (18" - 30" 11" x 11"), (36" 14" x 14").
- Column size: (18" - 24" 2.1/2"), (30" - 36" 3")

PRODUCT CODE	PRICE		SIZE/INCHES			WEIGHT		VOL FT <sup>3</sup>
	PAINTED	CHROME	H	W	D	LBS		
TTFL3P18	1450	1657	28		18	11	7	
TTFL3P22	1472	1679	28		22	12	13	
TTFL3P24	1491	1699	28		24	13	15	
TTFL3P30	1533	1740	28		30	15	15	
TTFL3P36	1554	1781	28		36	18	24	

**LL4S • 4-Star Table Leg With Bullnose End**



- Leg Plate is 11" x 11" for 26" and 30" spread and 14" x 14" for 36" spread.
- For the caster option specify "CS" at the end of the code with a \$68 upcharge

PRODUCT CODE	PRICE		SIZE/INCHES			WEIGHT		VOL FT <sup>3</sup>
	PAINTED	CHROME	H	W	D	LBS		
LL4S18	589	696	28	18	18	15	7	
LL4S26	697	804	28	26	26	18	15	
LL4S30	745	852	28	30	30	20	15	
LL4S36	816	923	28	36	36	22	24	

**LL4S-42 • Bistro Leg With Bullnose End**



- Leg Plate is 11" x 11" for 26" and 30" spread.

PRODUCT CODE	PRICE		SIZE/INCHES			WEIGHT		VOL FT <sup>3</sup>
	PAINTED	CHROME	H	W	D	LBS		
LL4S2642	799	907	40.5	26	26	22	18	
LL4S3042	851	957	40.5	30	30	24	23	
LL4S3642	1029	1135	40.5	36	36	26	28	

**LLT • "T" Table Leg With Bullnose End**

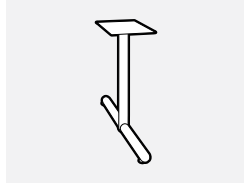

- Leg Plate is 11" x 11"
- For the caster option specify "CS" at the end of the code with a \$34 upcharge

PRODUCT CODE	PRICE		SIZE/INCHES			WEIGHT		VOL FT <sup>3</sup>
	PAINTED	CHROME	H	W	D	LBS		
LLT18	258	365	28	18	6	9	2	
LLT26	275	382	28	26	6	11	3	
LLT30	284	389	28	30	6	13	3	
LLT36	501	606	28	36	6	15	3	

**LLTT • "TT" Table Leg With Bullnose End**



- Leg Plate is 11"x 24"
- For the caster option specify "CS" at the end of the code with a \$34 upcharge

PRODUCT CODE	PRICE		SIZE / INCHES			WEIGHT		VOL FT <sup>3</sup>
	PAINTED	CHROME	H	W	D	LBS		
LLTT18	431	565	28	18	6	13	2	
LLTT26	452	587	28	26	6	20	3	
LLTT30	479	612	28	30	6	24	3	
LLTT36	685	817	28	36	6	26	3	
LLTT42	858	993	28	42	6	31	4	

**LLSQ • Square Post Leg**

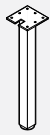

- 2.5" x 2.5" square tubular leg provides support for worksurfaces.
- Top plate welded to leg.
- 8" x 8" plate attached with #10 3/4" wood screws included.
- 1" height adjustment range.

PRODUCT CODE	PRICE		SIZE / INCHES			WEIGHT		VOL FT <sup>3</sup>
	PAINTED	CHROME	H	W	D	LBS		
LLSQ25X25H28	200	302	28	2.5	2.5	9	0.17	

**LATBL • Tapered Leg**



- Tapered leg provides support for worksurfaces.
- Top plate welded to leg.
- 8" x 8" plate attached with #10 3/4" wood screws included.
- 1" height adjustment range.
- Bottom of leg tube is a 1" diameter and top is 2 3/8" diameter.

PRODUCT CODE	PRICE		SIZE / INCHES			WEIGHT		VOL FT <sup>3</sup>
	PAINTED	CHROME	H	W	D	LBS		
LATBL28	227	334	28	3	3	9	0.17	

**BHML • Monoleg**



- 3" diameter Monoleg provides support for worksurfaces.
- Top plate welded to leg.
- 8" x 8" plate attached with #10 3/4" wood screws included.
- 1" height adjustment range.

PRODUCT CODE	PRICE		SIZE / INCHES			WEIGHT		VOL FT <sup>3</sup>
	PAINTED	CHROME	H	W	D	LBS		
BHML03	190	297	28	3	3	9	0.17	

**L2BHML • Monoleg**

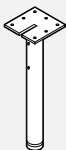

- 3" diameter Monoleg provides support for worksurfaces.
- Cut-out top plate welded to leg. Cut-out accepts 3/4" modesty panel.
- 8" x 8" plate attached with #10 3/4" wood screws included.
- 1" height adjustment range.

PRODUCT CODE	PRICE		SIZE / INCHES			WEIGHT		VOL FT <sup>3</sup>
	PAINTED	CHROME	H	W	D	LBS		
L2BHML03	173	280	28	3	3	9	0.17	

**LBHML06 • 6" Monoleg**

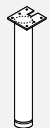

- 6" diameter Monoleg provides support for worksurfaces.
- Top plate welded to leg flush.
- 8" x 8" plate attached with #10 3/4" wood screws, included.
- 1" height adjustment range.
- Leg is offset flush to edge.

PRODUCT CODE	PRICE		SIZE / INCHES			WEIGHT		VOL FT <sup>3</sup>
	PAINTED	CHROME	H	W	D	LBS		
LBHML06	287	421	28	6	6	9	0.17	

**FOLDLEG • Folding Leg**



- Sold as a set of two.
- Available in only in (SIL) Silver or (BLK) Black.

PRODUCT CODE	PRICE	SIZE / INCHES			WEIGHT LBS	VOL FT <sup>3</sup>
		H	W	D		
FOLDLEG	541	28	24.625	3	11	7

**LHC • HAT Channel for Conference Tables**

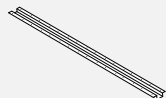

- See chart on page H.2

PRODUCT CODE	PRICE	SIZE / INCHES			WEIGHT LBS	VOL FT <sup>3</sup>
		H	W	D		
LHC40	75	1.4	40	5	4	0.20
LHC46	83	1.4	46	5	6	0.22
LHC52	91	1.4	52	5	7	0.25
LHC58	102	1.4	58	5	8	0.28
LHC64	113	1.4	64	5	9	0.31
LHC70	124	1.4	70	5	10	0.33

**BRTSLxxC • Single Leg Assembly (Casters)**

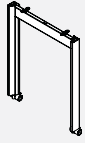

- Two Single Leg Assemblies form the structure of a table.
- 40mm white locking casters with grey tires; steel frame, aluminum legs.
- Anodized aluminum leg upcharge \$67.
- Please specify paint finish for support.

PRODUCT CODE	PRICE	SIZE/INCHES			WEIGHT VOL	
		H	W	D	LBS	FT <sup>3</sup>
L2BRTSL24C	592	28	2.5	24	8	1.34
L2BRTSL30C	615	28	2.5	30	8	1.41
L2BRTSL36C	641	28	2.5	36	8	1.81

**BRTSLxxL • Single Leg Assembly (Levelers)**

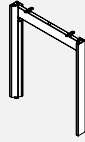

- Two Single Leg Assemblies form the structure of a table.
- One leg can be shared by 2 adjoining worksurfaces.
- Leveling glides, steel frame, aluminum legs.
- Anodized aluminum leg upcharge \$67.
- Please specify paint finish for support.
- Please specify 2 beams when using BRTSL36L.

PRODUCT CODE	PRICE	SIZE/INCHES			WEIGHT VOL	
		H	W	D	LBS	FT <sup>3</sup>
L2BRTSL24L	590	28	2.5	24	8	1.34
L2BRTSL30L	616	28	2.5	30	8	1.34
L2BRTSL36L	653	28	2.5	36	9	1.50

**BRTBAxxL • Back-2-Back Leg Assembly (Levelers)**

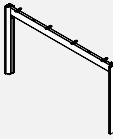

- Two Back-2-Back Leg Assemblies form the structure of Back-2-Back Tables.
- One double leg can be shared by 4 adjoining worksurfaces.
- Leveling, steel frame, aluminum legs.
- Anodized aluminum leg upcharge \$67.
- Please specify paint finish for support.

PRODUCT CODE	PRICE	SIZE/INCHES			WEIGHT VOL	
		H	W	D	LBS	FT <sup>3</sup>
L2BRTBA34L	538	28	2.5	34	10	2.47
L2BRTBA51L	582	28	2.5	50.5	12	2.96
L2BRTBA63L	606	28	2.5	62.5	13	3.21

**BRTHLxxxxC • Single "H" Leg Assembly (Casters)**

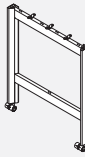

- Two Single Leg Assemblies form the structure of a table.
- Leveling glides, steel frame, aluminum legs.
- Anodized aluminum leg upcharge \$67.
- Please specify paint finish for support.
- Note:
- 24" deep tables must have three (3) beams at the top, and one beam (BRTBBxxC "Bottom Table Beam") at the bottom.
- 30" and 36" deep tables must have four (4) beams at the top, and one beam (BRTBBxxC "Bottom Table Beam") at the bottom.

PRODUCT CODE	PRICE	SIZE/INCHES			WEIGHT VOL	
		H	W	D	LBS	FT <sup>3</sup>
L2BRTHL3624C	673	35	2.5	24	14	1.68
L2BRTHL3630C	713	35	2.5	30	16	1.76
L2BRTHL3636C	806	35	2.5	36	18	2.26
L2BRTHL4224C	703	41	2.5	24	15	1.96
L2BRTHL4230C	744	41	2.5	30	17	2.06
L2BRTHL4236C	838	41	2.5	36	19	2.65

**BRTHLxxxxL • Single "H" Leg Assembly (Levelers)**

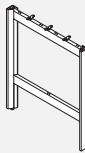

- Two Single Leg Assemblies form the structure of a table.
- One leg can be shared by 2 adjoining worksurfaces.
- Leveling glides, steel frame, aluminum legs.
- Anodized aluminum leg upcharge \$67.
- Please specify paint finish for support.
- Note:
- 24" deep tables must have three (3) beams at the top, and one beam (BRTBBxxC "Bottom Table Beam") at the bottom.
- 30" and 36" deep tables must have four (4) beams at the top, and one beam (BRTBBxxC "Bottom Table Beam") at the bottom.

PRODUCT CODE	PRICE	SIZE/INCHES			WEIGHT VOL	
		H	W	D	LBS	FT <sup>3</sup>
L2BRTHL3624L	619	35	2.5	24	14	1.68
L2BRTHL3630L	659	35	2.5	30	16	1.76
L2BRTHL3636L	751	35	2.5	36	18	2.26
L2BRTHL4224L	651	41	2.5	24	15	1.96
L2BRTHL4230L	691	41	2.5	30	17	2.06
L2BRTHL4236L	783	41	2.5	36	19	2.65

**BRTSLLxx • Single Loop Leg**

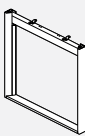

- Two Single Leg Assemblies form the structure of a table.
- One leg can be shared by 2 adjoining worksurfaces.
- Leveling glides, steel frame, aluminum legs.
- Anodized aluminum leg upcharge \$67.
- Please specify paint finish for support.
- Please specify two beams when using BRTSLL36L.

PRODUCT CODE	PRICE	SIZE/INCHES			WEIGHT VOL	
		H	W	D	LBS	FT <sup>3</sup>
L2BRTSLL24L	512	28	2.5	24	11.00	1.01
L2BRTSLL30L	545	28	2.5	30	13.75	1.26
L2BRTSLL36L	589	28	2.5	36	16.50	1.51

**BRTBALLxx • Back-2-Back Loop Leg**

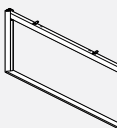

- Two Back-2-Back Leg Assemblies form the structure of Back-2-Back Tables.
- One double leg can be shared by 4 adjoining worksurfaces.
- Leveling glides, steel frame, aluminum legs.
- Anodized aluminum leg upcharge \$67.
- Please specify paint finish for support.

PRODUCT CODE	PRICE	SIZE/INCHES			WEIGHT VOL	
		H	W	D	LBS	FT <sup>3</sup>
L2BRTBALL51L	711	28	2.5	50.5	23.14	2.12
L2BRTBALL63L	743	28	2.5	62.5	28.64	2.62

**LVB • Visual Board**

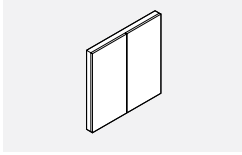

• See page H.1 for technical information.

PRODUCT CODE	FINISH		SIZE/INCHES			WEIGHT		VOL FT <sup>3</sup>
	LP/B	HP/B	H (LP/B)	W	D	LBS		
LVB48	1969	2180	48	48	8	154	10	
LVB48MG	2009	2337	48	48	8	154	10	

**L2CT • Collaboration Tables With Integrated Wire Management**

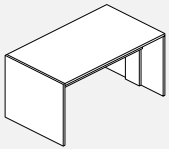

- Units Shipped knocked down (KD)
- Footrest to be ordered separately.
- Add "FR" to the end of the code for a footrail and add \$2,446 to the list price.
- Foot rail kit will include a quantity of two 2" diameter rails and 4 flanges.
- "W" thick (1 7/16") top and gables.
- Low pressure modesty panel.

**Standard Grommet Location:**

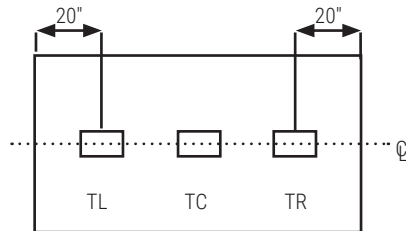

Please see Accessories Section for power grommets.

Half Modesty at 15" high.

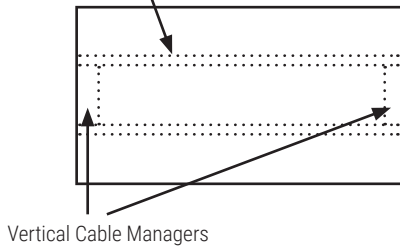

PRODUCT CODE	FINISH "W"	SIZE / INCHES		WEIGHT LBS	VOL FT <sup>3</sup>
		W	D		
L2CT3060H29	2310	60	30	171	13
L2CT3066H29	2411	66	30	180	14
L2CT3072H29	2511	72	30	189	15
L2CT3078H29	2610	78	30	198	16
L2CT3084H29	2709	84	30	207	18
L2CT3096H29	2907	96	30	216	20
L2CT3060H36	2450	60	30	176	19
L2CT3066H36	2554	66	30	185	21
L2CT3072H36	2651	72	30	194	23
L2CT3078H36	2749	78	30	203	24
L2CT3084H36	2851	84	30	212	26
L2CT3096H36	3050	96	30	221	30
L2CT3060H42	2650	60	30	181	25
L2CT3066H42	2749	66	30	190	28
L2CT3072H42	2850	72	30	199	30
L2CT3078H42	2949	78	30	208	33
L2CT3084H42	3049	84	30	217	35
L2CT3096H42	3248	96	30	226	40
L2CT3660H29	2595	60	36	180	15
L2CT3666H29	2703	66	36	189	17
L2CT3672H29	2816	72	36	198	18
L2CT3678H29	2926	78	36	207	20
L2CT3684H29	3035	84	36	216	21
L2CT3696H29	3259	96	36	225	24
L2CT3660H36	2764	60	36	185	23
L2CT3666H36	2871	66	36	194	25
L2CT3672H36	2984	72	36	203	27
L2CT3678H36	3094	78	36	212	29
L2CT3684H36	3206	84	36	221	32
L2CT3696H36	3427	96	36	230	36
L2CT3660H42	2988	60	36	190	30
L2CT3666H42	3099	66	36	199	33
L2CT3672H42	3210	72	36	208	36
L2CT3678H42	3319	78	36	217	39
L2CT3684H42	3431	84	36	226	42
L2CT3696H42	3654	96	36	235	48
L2CT4260H29	2875	60	42	189	18
L2CT4266H29	2997	66	42	198	19
L2CT4272H29	3119	72	42	207	21
L2CT4278H29	3243	78	42	216	23
L2CT4284H29	3363	84	42	225	25
L2CT4296H29	3609	96	42	234	28
L2CT4260H36	3072	60	42	194	26
L2CT4266H36	3195	66	42	203	29
L2CT4272H36	3315	72	42	212	32
L2CT4278H36	3438	78	42	221	34
L2CT4284H36	3563	84	42	230	37
L2CT4296H36	3806	96	42	239	42
L2CT4260H42	3326	60	42	199	35
L2CT4266H42	3448	66	42	208	39
L2CT4272H42	3571	72	42	217	42
L2CT4278H42	3692	78	42	226	46
L2CT4284H42	3815	84	42	235	49
L2CT4296H42	4059	96	42	244	56

L2CTV • Collaboration Tables With Media-Wall-Integrated Wire Management

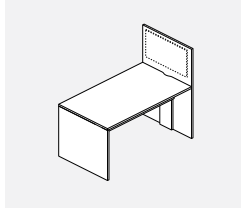

- Units Shipped knocked down (KD)
- Footrest to be ordered separately.
- Add "FR" to the end of the code for a foot rail and add \$2,446 to the list price.
- Foot rail kit will include a quantity of two 2" diameter rails and 4 flanges.
- Unit includes TV/Display bracket & mounting hardware.
- "W" thick (1 7/16") top and gables.
- Low pressure modesty panel.

Standard Grommet Location:

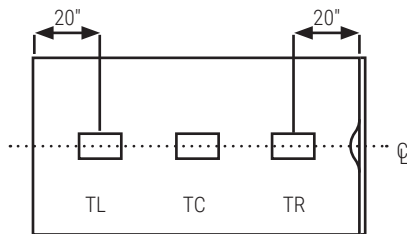

Please see Accessories Section for power grommets.

Half Modesty at 15" high.

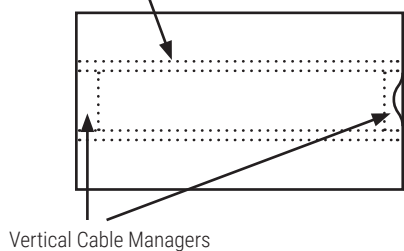

PRODUCT CODE	FINISH "W"	SIZE/INCHES		WEIGHT LBS	VOL FT <sup>3</sup>
		W	D		
L2CTV4260H29H66	4253	60	42	192	18
L2CTV4266H29H66	4376	66	42	201	19
L2CTV4272H29H66	4497	72	42	210	21
L2CTV4278H29H66	4620	78	42	219	23
L2CTV4284H29H66	4742	84	42	228	25
L2CTV4296H29H66	4987	96	42	237	28
L2CTV4860H29H66	4620	60	48	198	20
L2CTV4866H29H66	4751	66	48	207	22
L2CTV4872H29H66	4886	72	48	216	24
L2CTV4878H29H66	5018	78	48	225	26
L2CTV4884H29H66	5154	84	48	234	28
L2CTV4896H29H66	5418	96	48	243	32
L2CTV4260H36H72	4448	60	42	197	26
L2CTV4266H36H72	4573	66	42	206	29
L2CTV4272H36H72	4695	72	42	215	32
L2CTV4278H36H72	4816	78	42	224	34
L2CTV4284H36H72	4937	84	42	233	37
L2CTV4296H36H72	5181	96	42	242	42
L2CTV4860H36H72	4842	60	48	203	30
L2CTV4866H36H72	4976	66	48	212	33
L2CTV4872H36H72	5110	72	48	221	36
L2CTV4878H36H72	5244	78	48	230	39
L2CTV4884H36H72	5377	84	48	239	42
L2CTV4896H36H72	4969	96	48	248	48
L2CTV4260H42H72	4604	60	42	202	35
L2CTV4266H42H72	4726	66	42	211	39
L2CTV4272H42H72	4848	72	42	220	42
L2CTV4278H42H72	5016	78	42	229	46
L2CTV4284H42H72	5093	84	42	238	49
L2CTV4296H42H72	5382	96	42	247	56
L2CTV4860H42H72	5012	60	48	208	40
L2CTV4866H42H72	5144	66	48	217	44
L2CTV4872H42H72	5280	72	48	226	48
L2CTV4878H42H72	5412	78	48	235	52
L2CTV4884H42H72	5547	84	48	244	56
L2CTV4896H42H72	5813	96	48	253	64

**MSPDM • 1 Duplex, 1 Data**



- Includes one duplex and two data jacks (both RJ45, Cat6)..
- Black plastic

PRODUCT CODE	PRICE	SIZE/INCHES			WEIGHT LBS	VOL FT <sup>3</sup>
		H	W	D		
MSPDM	355	2.75	6.5	3.5	2	0.1

**BG5 • Rectangular Grommet**

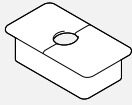

- Option (BLK) Black Plastic (GRY) Grey Plastic (WHT) White Plastic

PRODUCT CODE	PRICE	SIZE/INCHES			WEIGHT LBS	VOL FT <sup>3</sup>
		H	W	D		
BG5	58		3.5	2		

**GCRTMCS401 • Recessed Power Block, 1 Duplex, 1 Data Knock-out, 1 Power Duplex**

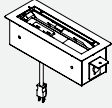

- Single sided recessed power block with 1 regular duplex and 1 data knock-out on top, 1 power duplex on bottom.
- 10 ft power cord with straight plug.
- Telecom plates ordered separately.
- Available in Black - B, Tungsten - T or Designer White - W as indicated by last letter of model number; duplexes always grey.
- Not approved for daisy-chain applications.

PRODUCT CODE	PRICE	SIZE/INCHES			WEIGHT LBS	VOL FT <sup>3</sup>
		H	W	D		
GCRTMCS401B	867	10.78	4.22	4.86	4.3	0.51
GCRTMCS401T	867	10.78	4.22	4.86	4.3	0.51
GCRTMCS401W	867	10.78	4.22	4.86	4.3	0.51

**GCRTMCS421 • Recessed Power Block, 1 Power including USB A+C, 1 Data Knock-out, 1 Power Duplex**

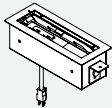

- Single sided recessed power block with 1 power and USB A+C duplex and 1 data knock-out on top, 1 power duplex on bottom.
- USB Type A port charges maximum 2.4 amps at 5V and Type C port charges maximum 3 amps at 5V.
- 10 ft power cord with straight plug.
- Telecom plates ordered separately.
- Available in Black - B, Tungsten - T or Designer White - W as indicated by last letter of model number; duplexes always grey.
- Not approved for daisy-chain applications.

PRODUCT CODE	PRICE	SIZE/INCHES			WEIGHT LBS	VOL FT <sup>3</sup>
		H	W	D		
GCRTMCS421B	1139	10.78	4.22	4.86	4.3	0.51
GCRTMCS421T	1139	10.78	4.22	4.86	4.3	0.51
GCRTMCS421W	1139	10.78	4.22	4.86	4.3	0.51

**GCRTMCS602 • Recessed Power Block, 2 Duplex, 2 Data Knock-outs, 1 Power Duplex**

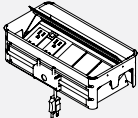

- Double-sided recessed power block with 2 regular duplex and 2 data knock-outs on top, 1 power duplex on bottom.
- 10 ft power cord with straight plug.
- Telecom plates ordered separately.
- Available in Black - B, Tungsten - T or Designer White - W as indicated by last letter of model number; duplexes always grey.
- Not approved for daisy-chain applications.

PRODUCT CODE	PRICE	SIZE/INCHES			WEIGHT LBS	VOL FT <sup>3</sup>
		H	W	D		
GCRTMCD602B	990	10.78	6.22	4.86	5.9	0.51
GCRTMCD602T	990	10.78	6.22	4.86	5.9	0.51
GCRTMCD602W	990	10.78	6.22	4.86	5.9	0.51

**GCRTMCS602 • Recessed Power Block, 2 Duplex, 2 Data Knock-outs, 1 Power Duplex**

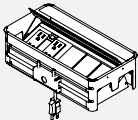

- Double-sided recessed power block with 1 regular duplex, 1 power and USB A+C and 2 data knock-outs on top, 1 power duplex on bottom.
- USB Type A port charges maximum 2.4 amps at 5V and Type C port charges maximum 3 amps at 5V.
- 10 ft power cord with straight plug.
- Telecom plates ordered separately.
- Available in Black - B, Tungsten - T or Designer White - W as indicated by last letter of model number; duplexes always grey.
- Not approved for daisy-chain applications.

PRODUCT CODE	PRICE	SIZE/INCHES			WEIGHT LBS	VOL FT <sup>3</sup>
		H	W	D		
GCRTMCD622B	1247	10.78	6.22	4.86	6.1	0.51
GCRTMCD622T	1247	10.78	6.22	4.86	6.1	0.51
GCRTMCD622W	1247	10.78	6.22	4.86	6.1	0.51

**GCRTMCS622 • Recessed Power Block, 2 Power Including USB A+C, 2 Data Knock-outs, 1 Power Duplex**

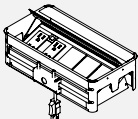



- Double-sided recessed power block with 2 power and USB A+C and 2 data knock-outs on top, 1 power duplex on bottom.
- USB Type A port charges maximum 2.4 amps at 5V and Type C port charges maximum 3 amps at 5V.
- 10 ft power cord with straight plug.
- Telecom plates ordered separately.
- Available in Black - B, Tungsten - T or Designer White - W as indicated by last letter of model number; duplexes always grey.
- Not approved for daisy-chain applications.

PRODUCT CODE	PRICE	SIZE/INCHES			WEIGHT LBS	VOL FT <sup>3</sup>
		H	W	D		
GCRTMCD642B	1502	10.78	6.22	4.86	6.3	0.51
GCRTMCD642T	1502	10.78	6.22	4.86	6.3	0.51
GCRTMCD642W	1502	10.78	6.22	4.86	6.3	0.51



**Telecom Plates**

	PRODUCT CODE	PRICE
	Black telecom plate with 2 RJ45 cat 6 data ABLBB	336
	Black telecom plate with 3 RJ45 cat 6 data ABLBBB	493
	Black telecom plate with 4 RJ45 cat 6 data ABLBBBB	652

**TERINA TABLES**

Terina™ is a multi-purpose table that allows you to quickly adapt your space to suit your needs. The simple flip-top mechanism is designed for single-handed operation. Tables nest in an upright position to minimize storage space.

**Worksurfaces**

Laminate surfaces (B) are 1-1/16" thick tops constructed of 45lb. density particle board with high pressure laminate and finished on the underside of the surface with a kraft paper backing. Veneer (V) surfaces are 1-3/16" thick tops constructed of 45 lb. density particle board and are balanced on the underside with veneer (unfinished). Worksurfaces are pre-drilled for alignment of the Terina base.

**Base**

Tables feature an aluminum leg, cross beam and die-cast foot. Legs and cross beam are available in all standard panel painted finishes. Die-cast foot is always in polished aluminum finish. Foot span is 36". Stacking depth of 9".

**Casters**

Casters are standard on all tables. 2-3/8" dual wheel casters with manual lock. Full 360° swivel. Suggested for carpeted surfaces. Available in grey only.

**Ganging Plates**

Ganging plates are available for ganging adjoining tables together. Ganging plates are black epoxy coated steel plates with two thumbscrews.

**Wire Management**

Wire management option is a snap-in channel that fits on the interior of the leg or on the understand of the flip-top cross beam.

**Modesty Panels**

10" Modesty panel affixes to the top and base, articulating when it folds down. available in all standard LP laminate and veneer finishes.

**GFT-R • Rectangular Flip-Top Training Table**



- B and V edge tops have square corners

PRODUCT CODE	PRICE B	SIZE/INCHES			WEIGHT		VOL FT <sup>3</sup>
		H	W	D	LBS		
GFT2448R	1668	29	48	24	48	6	
GFT2454R	1740	29	54	24	53	6	
GFT2460R	1809	29	60	24	55	7	
GFT2466R	1834	29	66	24	61	7	
GFT2472R	1861	29	72	24	66	7	
GFT3048R	1740	29	48	30	53	6	
GFT3054R	1776	29	54	30	55	6	
GFT3060R	1834	29	60	30	61	7	
GFT3066R	1858	29	66	30	66	7	
GFT3072R	1898	29	72	30	68	7	

**GFT-M • Folding Modesty Panel**

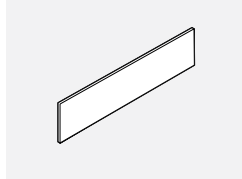

- Includes hardware to connect to Terina Tables.
- Woodgrain modesty panels over 60" will have the woodgrain run horizontally, whereas others will run vertically.
- Due to location of the modesty panel, only MSPDM and GMDSF10 grommets can be used on Terina tables with modesty panels.

PRODUCT CODE	PRICE LP	SIZE/INCHES			WEIGHT		VOL FT <sup>3</sup>
		H	W	D	LBS		
GFT48M	292	10	46	0.75	11	1	
GFT54M	308	10	52	0.75	13	1	
GFT60M	324	10	58	0.75	15	1	
GFT66M	340	10	64	0.75	18	2	
GFT72M	360	10	70	0.75	20	2	

**GFTCM • Wire Manager**

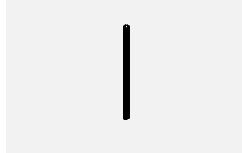

- Set of four
- Each piece is 10" long

PRODUCT CODE	PRICE	SIZE/INCHES			WEIGHT		VOL FT <sup>3</sup>
		H	W	D	LBS		
GFTCM04BLK	52	2	10	2	1	1	

**GFCNGFP • Ganging Flush Plate**

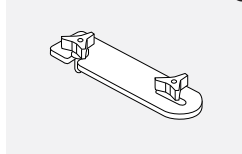

- Please specify application so that inserts may be added to surface.

PRODUCT CODE	PRICE	SIZE/INCHES			WEIGHT		VOL FT <sup>3</sup>
		H	W	D	LBS		
GFCNGFP	52	2.5	5	0.1	0.22	0.01	



**GUIDELINE FOR ORDERING PRODUCT**

**CODES:** The price list uses a numbering system with meaningful alphanumeric characters to create a simple-to-understand product number. This makes specifying the product much easier and more accurate.

**SPECIFICATION EXAMPLE OF A HEIGHT ADJUSTABLE TABLE**

Ordered as components, please order:

**1. BASE**

**PRODUCT CODE:**

- FT - FreeFit
- 5 - Standard Range Legs
- 2 - Leg Quantity
- SF - Small Frame
- 24 - Depth
- CL - C-leg Style
- S - Standard Controller

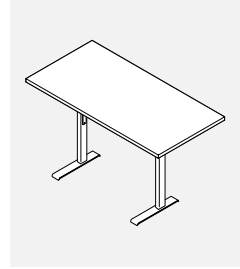

**OPTIONS:**

Frame Style: 5 - Standard Range Frame 27.5" to 47"  
6 - Extended Range Frame 22.5" to 48.5"

Leg Quantity: 1 - 1 Leg for return Kit  
2 - 2 Leg table Kit  
3 - 3 Leg Table Kit  
4 - 4 Leg Table Kit

Frame Size: SF - Small Frame, for 48" to 60" wide Tables  
LF - Large Frame, for 66" to 84" wide Tables

Worksurface Depth: 24 - For 23" deep worksurfaces  
30 - For 29" and 35" deep worksurfaces

Leg Style: CL - C Shaped Table Leg  
TL - T Shaped Table Leg

Controller Style: S - Standard Controller

**Base Finish:**

- BLK - Black
  - DWT - Designer White
  - TUN - Tungsten
- The following finishes are available for minimum orders of 72 legs for special projects. For customer who request the finishes below, and do not meet the 72 legs threshold, a 30% surcharge will apply to the base and an extended lead time of 6 weeks.

- BZD - Blizzard
- CHR - Charcoal
- NEV - Nevada
- SDT - Stonedust
- SIL - Silver
- FOG - Steel
- TPE - Taupe

**2. TOP**

**PRODUCT CODE:**

FTWR2436

Top: LP = LP (Low Pressure Laminate) Thickness 1"  
HP = HP (High Pressure Laminate) Thickness 1 1/16"

Top Finish Laminate: Choose Colour

Top PVC Edging: Choose Colour

**3. ACCESSORIES**

**PRODUCT CODE:**

FTAEC12

**Base Finish:**

- BLK - Black
  - DWT - Designer White
  - TUN - Tungsten
- The following finishes are available for minimum orders of 72 legs for special projects. For customer who request the finishes below, and do not meet the 72 legs threshold, a 30% surcharge will apply to the base and an extended lead time of 6 weeks.

- BZD - Blizzard
- CHR - Charcoal
- NEV - Nevada
- SDT - Stonedust
- SIL - Silver
- FOG - Steel
- TPE - Taupe

## HEIGHT-ADJUSTABLE TABLES • PRODUCT MAP

### C-Leg Base

Standard and Extended Range

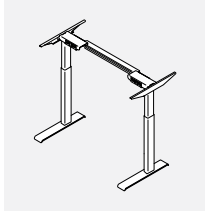

### 90 Degree Retrofit Kit with C-Leg

Standard and Extended Range



### Single Frame

Standard and Extended Range

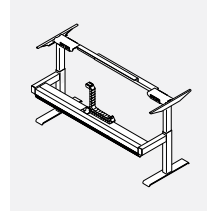

### T-Leg Base

Standard and Extended Range

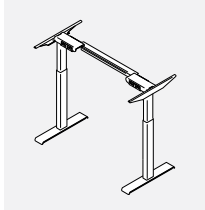

### 90 Degree Retrofit Kit with T-Leg

Standard and Extended Range



### Single End-of-Run Frame

Standard and Extended Range

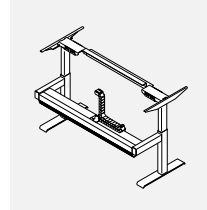

### 90 Degree Table Base

Equal Sides  
Standard and Extended Range

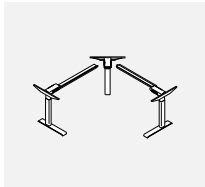

### 120 Degree Table Base

Standard and Extended Range

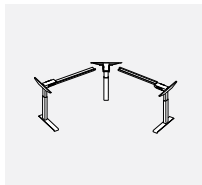

### Media Table Frame

Standard and Extended Range

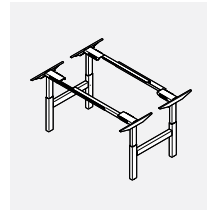

### 90 Degree Table Base, Unequal Sides

Standard and Extended Range

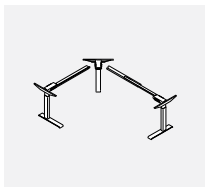

### Back-to-Back Frame

Standard and Extended Range



**FREEFIT GROMMET LOCATION**

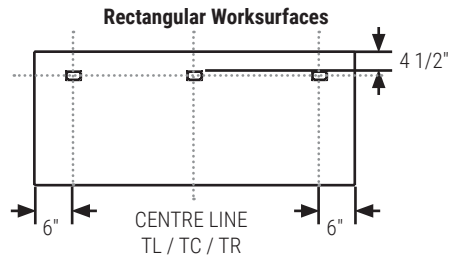
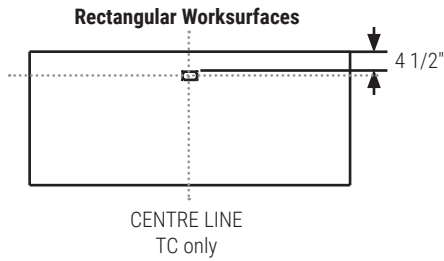

**120° Corner Table Top**

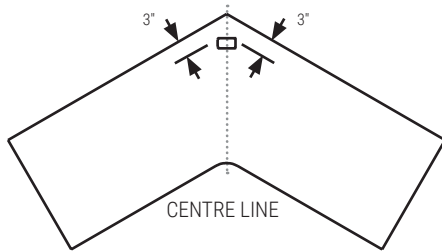

**90° Extended Corner Worksurface**

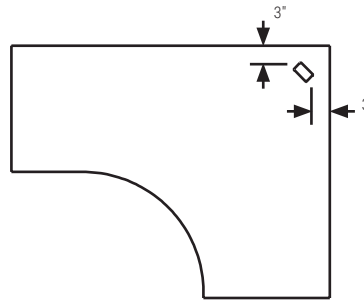

For FTWR worksurfaces 64" and larger, TL/TR, TL/TC and TC/TR are also available.

**GAADxx Grommets Rectangular Worksurface TL**

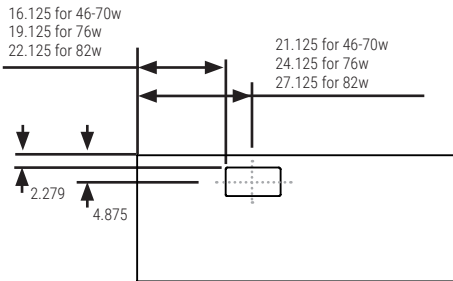

**GAADxx Grommets Rectangular Worksurface TR**

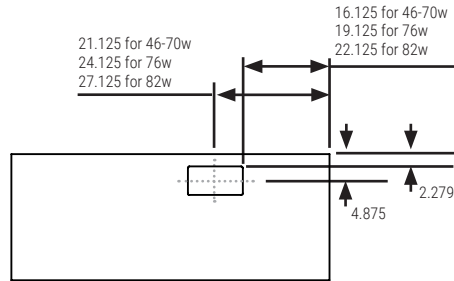

For Back-to-Back Tables and Freestanding Tables only. Not available for return table tops.

**Media Table Tops**

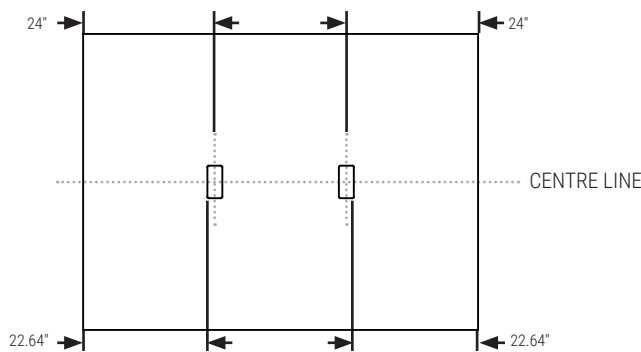

**GENERAL SPECIFICATION****FEATURES**

- Table frames feature 80 X 50 mm rectangular outer leg with the large tube attached to the foot.
- Open base design with ample room for chair and user's legs.
- Flat foot design includes adjustable (10mm) glides.
- All table frames include expandable width upper crossbars to create a variety of size tables.
- Tables have no lower crossbars.
- All table frames are easy to assemble with few parts.
- Tables are designed so that the paint will never mar on the leg during operation.
- Steel construction of the leg assembly tubing, feet and upper structure assemblies.
- Powder coat finishes for bases standard in (DWT) Designer White, (BLK) Black and (TUN) Tungsten.
- All standard Teknion laminate finishes are available.
- Sizes of tops are "nominal". Unless otherwise stated, actual depth is 1" less and actual width is 2" less than "nominal" size.
- Additional Finishes available minimum quantity of 72 legs (36 - 2 leg tables, 24 - 3 leg tables or 18 B2B Tables) Blizzard, Charcoal, Nevada, Silver, Steel, Stonedust, and Taupe
- All bases lift 350 lbs on two leg tables.
- All bases operate at 1.5" per second.
- Standard Range Frame adjusts from 27.5" to 47" including the worksurface.
- Extended Range Frame adjusts from 22.5" to 48.5" including the worksurface.
- Tops are warrantied for lifetime and bases are warrantied for 7 years.

**CERTIFICATIONS**

- Products are fully compliant with ANSI/BIFMA X5.5 – 2014, CAN/CGSB-44.227 - 2017; EN 60335-1 and UL962
- All Teknion Extended Range tables meet the BIFMA G1-2013 Ergonomic Guideline for "recommended adjustment range".

**EXTENDED RANGE COLUMNS**

- The 3-part construction ensures a short installation dimension combined with a long stroke length making the Extended Range Column the optimum choice no matter the height of the person using it. The middle profile of the column moves synchronously so the profiles are always in the same height optimizing the desk design and the stability.
- Compact design where guide and actuator functions are an integrated unit
- Reinforced column and optimized motor housing design for extra strength and stability
- Max. thrust 1200 N per column (12 mm spindle pitch)
- Max. speed 38 mm/s unloaded
- Installation dimension: 560 mm 518 mm (BIFMA)
- Stroke length: 650 mm 665 mm (BIFMA)
- Dimensions column: 50 x 80 mm (outer profile), 43.5 x 73.5 mm (middle profile) and 37 x 67 mm (inner profile)
- Low noise level
- No visible gliding pads

**STANDARD RANGE COLUMNS**

- The 2-part lifting column is a perfect choice for a wide range of different desk applications in the office.
- Compact design where guide and actuator functions are an integrated unit
- Reinforced column and optimized motor housing design for extra strength and stability
- Max. load 800 N per column
- Max. speed: 38 mm/s unloaded
- Standard installation dimension 645 mm
- Standard stroke length 500 mm
- Dimensions column: 50 x 80 mm (outer profile) and 43.5 x 73.5 mm (inner profile)
- Dimension motor housing: 177 x 97 x 46 mm
- Low noise level
- No visible gliding pads

**FOOT**

- FreeFit offers two foot styles either a "T" or "C".
- The feet are available in two different lengths (560 mm and 710 mm). The foot offers a recessed connection for the column and connects from the bottom with 4 bolts. Adjustable glides are standard

**DESK-MOUNT FRAME**

- Can be specified in two lengths Short Frame (SF) for tables 42" – 60" in length. Long Frames (LF) for tables 66"- 84" in length
- All metal parts Black
- Cantilever length: 550 mm
- Central or off-center placement of columns (T-desk and C-desk)
- Includes all connecting hardware

**CONTROL BOX****• Two leg tables come standard with a 200 W Control Box**

- Mains voltage 230 VAC, 50 Hz, or 120 VAC, 60 Hz
- Ultra-compact; length 210 mm length
- Lightweight control box; weight only approx. 400 g

**• Three Leg Tables come standard with a 300 W Control Box**

- can be connected up to 4 columns
- Mains voltage 100-240 VAC, 50-60 Hz (universal)
- Ultra-compact; length 265 mm length
- Lightweight control box; weight only approx. 500 g

**• Common features for the (200 W and 300 W):**

- Ultra-low; height only 38 mm
- Environment: Operation Storage
- Ambient temperature: 5 to 40 °C -10 to +50 °C
- Relative humidity: 20 to 80 % at 30 °C 20 to 80 % at 30 °C
- Atmospheric pressure: 700 to 1060 hPa 700 to 1060 hPa
  - Compact high-power SMPS (Switch Mode Power Supply)
  - Color: black
  - Protection against overload (EOP), by individual current limitation
  - The control box is designed with a soft start/stop function
  - Autodetection of the number and type of columns connected
  - Cable grooves at the bottom to optimize cable management
  - White plugs for easy recognition when mounting/dismounting
  - PVC-Free™
  - Low standby power consumption – only 0.1 W.
  - Exchangeable standard mains cable

**STANDARD UP/DOWN CONTROLLER**

- Features Bluetooth® connection, two favorite positions and a reminder via an LED to remind the users to use their desk. The Controller is activated by tilting the desk panel in the same direction as the desk is intended to drive. Via pulsating green and orange lights, the LED reminds the users to change positions. Using the integrated Bluetooth® and downloading the Desk Control™ App the user can also be reminded via notifications on computers and smart devices.

- Color: Black
- Black cable with RJ45 modular plug, 1700 mm straight
- PVC-Free™
- Featuring ZERO™: Very low power consumption in standby mode
- Approved according to EN 60335-1
- Approved according to UL962

**GENERAL SPECIFICATION ... CONTINUED****DISPLAY UP/DOWN CONTROLLER**

Features Bluetooth® connection, four favorite positions, a display to guide the users and a reminder via a light strip to remind the users to use their desks. The Controller is activated by tilting the desk panel in the same direction as the desk is intended to drive. The Display Controller features a modern discreet design with a glossy surface and an integrated display to ensure a clean and minimalist design. The display provides guidance to the users when operating the desk. Via pulsating green and orange lights, the light strip reminds the users to change positions. Using the integrated Bluetooth® and downloading the Desk Control™ App the users can also be reminded via notifications on smart devices.

- Color: Black
- Black cable with RJ45 modular plug, 1700 mm straight
- PVC-Free™
- Featuring ZERO™: Very low power consumption in standby mode
- Approved according to EN 60335-1
- Approved according to UL962

**ANTI-COLLISION SENSOR**

Features enhanced Anti-Collision protection which can limit material damage to a desk or an object if a collision occurs during driving of the desk. The sensor is a compact plug-in adapter based on gyroscope-technology, and it detects even little tilting of the desk when the desk is driving up or down. Upon detected tilting, the system stops and drives in the opposite direction to avoid collision and damage to the desk or the object. The sensor can detect both hard and soft obstacles. The Anti-Collision Sensor is standard on all desks.

- Reacts to angle changes bigger than 0.7° per second
- Just plug it in – no mounting required
- ZEROTM Power capable
- PVC-Free

**BATTERY BOX**

A high-performance lithium-Ion battery with a capacity of 2.15 Ah. On a full charge the table can cycle from 35 to 45 stroke lengths based upon the range of column selected and load on the table.

- Compact unit for easy handling and installation
- Battery alarm (audio) when charging is needed
- Battery charging indicator (LED light bars) indicating the capacity level
- Thermal switch protection, overcurrent protection
- Color: black
- Battery capacity: 2.15 Ah / 52 Wh
- Nominal voltage: 24 V DC
- Discharge current: 9 A (max)
- Maximum charging voltage: 40 V DC
- Charging current: 0.5 A
- Weight: 600 g

**USAGE**

- Ambient temperature: 5 to 40 °C
- Storage temperature: 0 to 45 °C
- Approved according to:  
EN 62133 (Battery safety testing)  
UL 1642 (Lithium cells, standard test)  
UN 38.3 (transportation of Lithium batteries)  
UL 2054 (Household and commercial batteries)  
EN 60335-1 with CBH Advanced

NOTE: All grommets must be specified separately.



**FT52xxxxCL • Standard Range Base With C-Legs**

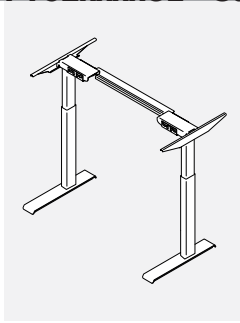

- Kit includes one beam, two cantilevers, two standard range columns and two C styled feet.
- SF indicates small frame for 42" to 60" tables.
- LF indicates large frame: 66" to 84" tables.
- For 23" deep worksurfaces, use 24" CL leg.
- For 29" and 35" deep worksurface, use 30" CL leg.
- For enhanced collision detection an Anti-Collision Desk Sensor included with every base.
- For Standard Up/Down Controller add (S) at the end of the code. For Display Controller, please add at "D" at the end of the product code and \$114 to the list price.
- Specify paint finish: BLK-Black, DWT-Designer White, TUN-Tungsten.

PRODUCT CODE	PRICE	HEIGHT MIN/MAX	WIDTH MIN/MAX	DEPTH MIN/MAX	WEIGHT LBS	VOL FT <sup>3</sup>
FT52SF24CL	2600	27.5" - 47"	42" - 60"	24" - 24"	56.12	2.3
FT52SF30CL	2621	27.5" - 47"	42" - 60"	30" - 36"	56.12	2.3
FT52LF24CL	2610	27.5" - 47"	66" - 84"	24" - 24"	59.3	2.3
FT52LF30CL	2629	27.5" - 47"	66" - 84"	30" - 36"	59.3	2.3

**FT52xxxxTL • Standard Range Base With T-Legs**

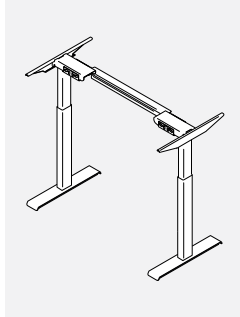

- Kit includes one beam, two cantilevers, two standard range columns and two T styled feet.
- SF indicates small frame for 42" to 60" tables.
- LF indicates large frame: 66" to 84" tables.
- For 23" deep worksurfaces, use 24" TL leg.
- For 29" deep worksurface, use 30" TL leg.
- For enhanced collision detection an Anti-Collision Desk Sensor included with every base.
- For Standard Up/Down Controller add (S) at the end of the code. For Display Controller, please add at "D" at the end of the product code and \$114 to the list price.
- Specify paint finish: BLK-Black, DWT-Designer White, TUN-Tungsten.

PRODUCT CODE	PRICE	HEIGHT MIN/MAX	WIDTH MIN/MAX	DEPTH MIN/MAX	WEIGHT LBS	VOL FT <sup>3</sup>
FT52SF24TL	2537	27.5" - 47"	42" - 60"	24" - 24"	56.12	2.3
FT52SF30TL	2557	27.5" - 47"	42" - 60"	30" - 36"	56.12	2.3
FT52LF24TL	2547	27.5" - 47"	66" - 84"	24" - 24"	59.3	2.3
FT52LF30TL	2567	27.5" - 47"	66" - 84"	30" - 36"	59.3	2.3

**FT62xxxxCL • Extended Range Base With C-Legs**

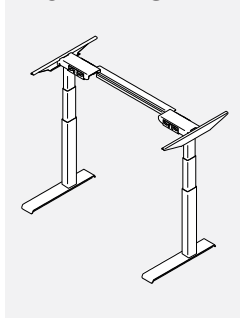

- Kit includes one beam, two cantilevers, two extended range columns and two C styled feet.
- SF indicates small frame for 42" to 60" tables.
- LF indicates large frame: 66" to 84" tables.
- For 23" deep worksurfaces, use 24" CL leg.
- For 29" and 35" deep worksurface, use 30" CL leg.
- For enhanced collision detection an Anti-Collision Desk Sensor included with every base.
- For Standard Up/Down Controller add (S) at the end of the code. For Display Controller, please add at "D" at the end of the product code and \$114 to the list price.
- Specify paint finish: BLK-Black, DWT-Designer White, TUN-Tungsten.

PRODUCT CODE	PRICE	HEIGHT MIN/MAX	WIDTH MIN/MAX	DEPTH MIN/MAX	WEIGHT LBS	VOL FT <sup>3</sup>
FT62SF24CL	2773	22.5" - 48.5"	42" - 60"	24" - 24"	59.3	2.3
FT62SF30CL	2792	22.5" - 48.5"	42" - 60"	30" - 36"	59.3	2.3
FT62LF24CL	2781	22.5" - 48.5"	66" - 84"	24" - 24"	64.7	2.3
FT62LF30CL	2802	22.5" - 48.5"	66" - 84"	30" - 36"	64.7	2.3

**FT62xxxxTL • Extended Range Base With T-Legs**

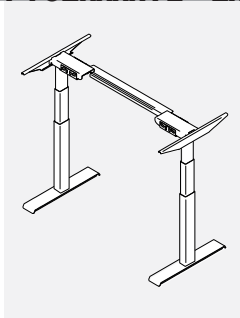

- Kit includes one beam, two cantilevers, two extended range columns and two T styled feet.
- SF indicates small frame for 42" to 60" tables.
- LF indicates large frame: 66" to 84" tables.
- For 23" deep worksurfaces, use 24" TL leg.
- For 29" deep worksurface, use 30" TL leg.
- For enhanced collision detection an Anti-Collision Desk Sensor included with every base.
- For Standard Up/Down Controller add (S) at the end of the code. For Display Controller, please add at "D" at the end of the product code and \$114 to the list price.
- Specify paint finish: BLK-Black, DWT-Designer White, TUN-Tungsten.

PRODUCT CODE	PRICE	HEIGHT MIN/MAX	WIDTH MIN/MAX	DEPTH MIN/MAX	WEIGHT LBS	VOL FT <sup>3</sup>
FT62SF24TL	2710	22.5" - 48.5"	42" - 60"	24" - 24"	59.3	2.3
FT62SF30TL	2730	22.5" - 48.5"	42" - 60"	30" - 36"	59.3	2.3
FT62LF24TL	2719	22.5" - 48.5"	66" - 84"	24" - 24"	64.7	2.3
FT62LF30TL	2738	22.5" - 48.5"	66" - 84"	30" - 36"	64.7	2.3

**FT539FxxxCL • Standard Range 90 Degree Table Base, Equal Sides**

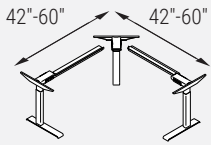

FS Base

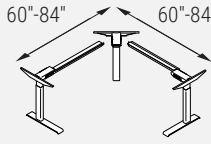

FL Base

- Kit includes two equal length beams, three cantilevers, one standard range corner column, two standard range columns and two C styled feet.

- FS indicates small base for 54" to 60" sided tables.

- FL indicates large base for 66" to 84" sided tables.

- For 23" deep worksurfaces, use 24" CL leg.

- For 29" and 35" deep worksurface, use 30" CL leg.

- For enhanced collision detection an Anti-Collision Desk Sensor included with every base.

- For Standard Up/Down Controller add (S) at the end of the code. For Display Controller, please add at "D" at the end of the product code and \$114 to the list price.

- Specify paint finish: BLK-Black, DWT-Designer White, TUN-Tungsten.

PRODUCT CODE	PRICE	HEIGHT MIN/MAX	WIDTH MIN/MAX	DEPTH MIN/MAX	WEIGHT LBS	VOL FT <sup>3</sup>
FT539FS24CL	3784	27.5" - 47"	42" - 60"	54" - 60"	79.1	4.7
FT539FS30CL	3804	27.5" - 47"	42" - 60"	54" - 60"	79.1	4.7
FT539FL24CL	3852	27.5" - 47"	66" - 84"	66" - 84"	59.3	4.7
FT539FL30CL	3871	27.5" - 47"	66" - 84"	66" - 84"	59.3	4.7

**FT539FSLxxCL • Standard Range 90 Degree Table Base, Unequal Sides**

42" - 60"      66" - 84"  
OR  
42" - 60"      66" - 84"

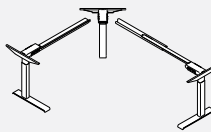

- Kit includes two beams (one small and one large), three cantilevers, one standard range corner column, two standard range columns and two C styled feet.

- For 23" deep worksurfaces, use 24" CL leg.

- For 29" and 35" deep worksurface, use 30" CL leg.

- For enhanced collision detection an Anti-Collision Desk Sensor included with every base.

- For Standard Up/Down Controller add (S) at the end of the code. For Display Controller, please add at "D" at the end of the product code and \$114 to the list price.

- Specify paint finish: BLK-Black, DWT-Designer White, TUN-Tungsten.

PRODUCT CODE	PRICE	HEIGHT MIN/MAX	WIDTH MIN/MAX	DEPTH MIN/MAX	WEIGHT LBS	VOL FT <sup>3</sup>
FT539FSL24CL	3817	27.5" - 47"	42" - 60"	66" - 84"	85.4	4.7
FT539FSL30CL	3837	27.5" - 47"	42" - 60"	66" - 84"	85.4	4.7

**FT639FxxxCL • Extended Range 90 Degree Table Base, Equal Sides**

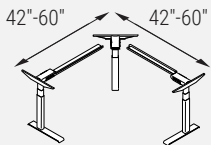

FS Base

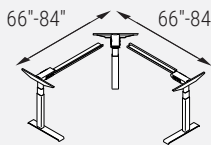

FL Base

- Kit includes two equal length beams, three cantilevers, one extended range corner column, two extended range columns and two C styled feet.

- FS indicates small base for 54" to 60" sided tables.

- FL indicates large base for 66" to 84" sided tables.

- For 23" deep worksurfaces, use 24" CL leg.

- For 29" and 35" deep worksurface, use 30" CL leg.

- For enhanced collision detection an Anti-Collision Desk Sensor included with every base.

- For Standard Up/Down Controller add (S) at the end of the code. For Display Controller, please add at "D" at the end of the product code and \$114 to the list price.

- Specify paint finish: BLK-Black, DWT-Designer White, TUN-Tungsten.

PRODUCT CODE	PRICE	HEIGHT MIN/MAX	WIDTH MIN/MAX	DEPTH MIN/MAX	WEIGHT LBS	VOL FT <sup>3</sup>
FT639FS24CL	4042	22.5" - 48.5"	42" - 60"	48" - 60"	76.5	4.7
FT639FS30CL	4062	22.5" - 48.5"	42" - 60"	48" - 60"	76.5	4.7
FT639FL24CL	4109	22.5" - 48.5"	66" - 84"	66" - 84"	82.7	4.7
FT639FL30CL	4129	22.5" - 48.5"	66" - 84"	66" - 84"	82.7	4.7

**FT639FSLxxCL • Extended Range 90 Degree Table Base, Unequal Sides**

42" - 60"      66" - 84"  
OR  
42" - 60"      66" - 84"

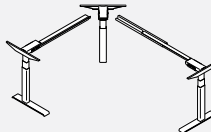

- Kit includes two beams (one small and one large), three cantilevers, one extended range corner column, two extended range columns and two C styled feet.

- For 23" deep worksurfaces, use 24" CL leg.

- For 29" and 35" deep worksurface, use 30" CL leg.

- For enhanced collision detection an Anti-Collision Desk Sensor included with every base.

- For Standard Up/Down Controller add (S) at the end of the code. For Display Controller, please add at "D" at the end of the product code and \$114 to the list price.

- Specify paint finish: BLK-Black, DWT-Designer White, TUN-Tungsten.

PRODUCT CODE	PRICE	HEIGHT MIN/MAX	WIDTH MIN/MAX	DEPTH MIN/MAX	WEIGHT LBS	VOL FT <sup>3</sup>
FT639FSL24CL	4076	22.5" - 48.5"	48" - 60"	48" - 84"	85.4	4.7
FT639FSL30CL	4096	22.5" - 48.5"	48" - 60"	48" - 84"	85.4	4.7

**FT51xRxxCL • Standard Range 90 Degree Table Retrofit Kit With C-Leg**

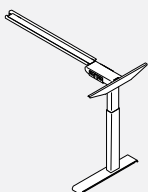

- Kit includes one beam, one cantilever, one standard range column and one C styled foot.

- SR indicates for short returns of 43" to 67" wide.

- LR indicates for long returns of 66" to 84" wide.

- For 23" deep worksurfaces, use 24" CL leg.

- For 29" and 35" deep worksurface, use 30" CL leg.

- Specify paint finish: BLK-Black, DWT-Designer White, TUN-Tungsten.

PRODUCT CODE	PRICE	HEIGHT MIN/MAX	WIDTH MIN/MAX	DEPTH MIN/MAX	WEIGHT LBS	VOL FT <sup>3</sup>
FT51SR24CL	1689	27.5" - 47"	24" - 48"	24" - 24"	24.9	4.7
FT51LR24CL	1723	27.5" - 47"	54" - 72"	24" - 24"	26.9	4.7
FT51SR30CL	1699	27.5" - 47"	24" - 48"	30" - 36"	24.9	4.7
FT51LR30CL	1733	27.5" - 47"	54" - 72"	30" - 36"	26.9	4.7

**FT51xRxxTL • Standard Range 90 Degree Table Retrofit Kit With T-Leg**

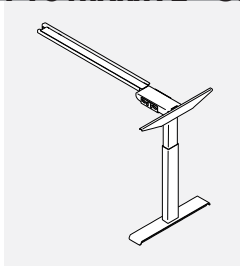

- Kit includes one beam, one cantilever, one standard range column and one T styled foot.
- SR indicates for short returns of 43" to 67" wide.
- LR indicates for long returns of 66" to 84" wide.
- For 23" deep worksurfaces, use 24" TL leg.
- For 29" and 35" deep worksurface, use 30" TL leg.
- Specify paint finish: BLK-Black, DWT-Designer White, TUN-Tungsten.

PRODUCT CODE	PRICE	HEIGHT MIN/MAX	WIDTH MIN/MAX	DEPTH MIN/MAX	WEIGHT LBS	VOL FT <sup>3</sup>
FT51SR24TL	1721	27.5" - 47"	24" - 48"	24" - 24"	24.9	2.3
FT51LR24TL	1754	27.5" - 47"	54" - 72"	24" - 24"	26.9	2.3
FT51SR30TL	1731	27.5" - 47"	24" - 48"	30" - 36"	24.9	2.3
FT51LR30TL	1765	27.5" - 47"	54" - 72"	30" - 36"	26.9	2.3

**FT61xRxxCL • Extended Range 90 Degree Table Retrofit Kit With C-Leg**

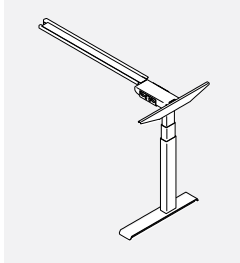

- Kit includes one beam, one cantilever, one extended range column and one C styled foot.
- SR indicates for short returns of 43" to 67" wide.
- LR indicates for long returns of 66" to 84" wide.
- For 23" deep worksurfaces, use 24" CL leg.
- For 29" and 35" deep worksurface, use 30" CL leg.
- Specify paint finish: BLK-Black, DWT-Designer White, TUN-Tungsten.

PRODUCT CODE	PRICE	HEIGHT MIN/MAX	WIDTH MIN/MAX	DEPTH MIN/MAX	WEIGHT LBS	VOL FT <sup>3</sup>
FT61SR24CL	1775	22.5" - 48.5"	24" - 48"	24" - 24"	27.6	4.7
FT61LR24CL	1809	22.5" - 48.5"	54" - 72"	24" - 24"	30.7	4.7
FT61SR30CL	1785	22.5" - 48.5"	24" - 48"	30" - 36"	27.6	4.7
FT61LR30CL	1819	22.5" - 48.5"	54" - 72"	30" - 36"	30.7	4.7

**FT61xRxxTL • Extended Range 90 Degree Table Retrofit Kit With T-Leg**

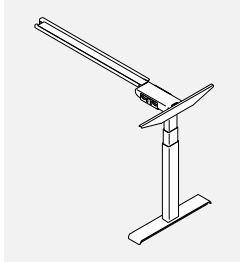

- Kit includes one beam, one cantilever, one extended range column and one T styled foot.
- SR indicates for short returns of 43" to 67" wide.
- LR indicates for long returns of 66" to 84" wide.
- For 23" deep worksurfaces, use 24" TL leg.
- For 29" and 35" deep worksurface, use 30" TL leg.
- Specify paint finish: BLK-Black, DWT-Designer White, TUN-Tungsten.

PRODUCT CODE	PRICE	HEIGHT MIN/MAX	WIDTH MIN/MAX	DEPTH MIN/MAX	WEIGHT LBS	VOL FT <sup>3</sup>
FT61SR24TL	1807	22.5" - 48.5"	24" - 48"	24" - 24"	27.6	2.3
FT61LR24TL	1841	22.5" - 48.5"	54" - 72"	24" - 24"	30.7	2.3
FT61SR30TL	1817	22.5" - 48.5"	24" - 48"	30" - 36"	27.6	2.3
FT61LR30TL	1851	22.5" - 48.5"	54" - 72"	30" - 36"	30.7	2.3

**FT531FxxxCL • Standard Range 120 Degree Table Base, Equal Sides**

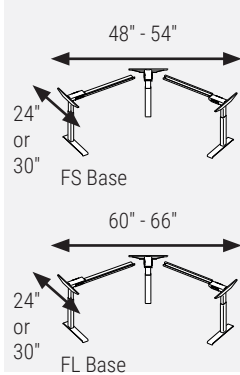

- Kit includes two beams, three cantilevers, one standard range corner column, two standard range columns and two C styled feet.
- FS indicates small base for 48" to 54" sided tables.
- FL indicates large base for 60" to 66" sided tables.
- For 23" deep worksurfaces, use 24" CL leg.
- For 29" and 35" deep worksurface, use 30" CL leg.
- For enhanced collision detection an Anti-Collision Desk Sensor included with every base.
- For Standard Up/Down Controller add (S) at the end of the code. For Display Controller, please add at "D" at the end of the product code and \$114 to the list price.
- Specify paint finish: BLK-Black, DWT-Designer White, TUN-Tungsten.

PRODUCT CODE	PRICE	HEIGHT MIN/MAX	WIDTH MIN/MAX	DEPTH MIN/MAX	WEIGHT LBS	VOL FT <sup>3</sup>
FT531FS24CL	3784	27.5" - 47"	48" - 54"	48" - 54"	59.7	4.7
FT531FS30CL	3804	27.5" - 47"	48" - 54"	48" - 54"	59.7	4.7
FT531FL24CL	3852	27.5" - 47"	60" - 66"	60" - 66"	59.7	4.7
FT531FL30CL	3871	27.5" - 47"	60" - 66"	60" - 66"	59.7	4.7

**FT631FxxxCL • Extended Range 120 Degree Table Base, Equal Sides**

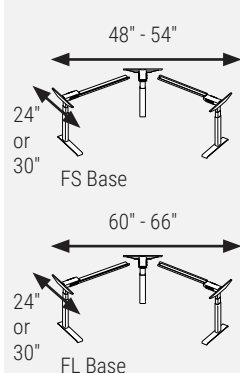

- Kit includes two beams, three cantilevers, one extended range corner column, two extended range columns and two C styled feet.
- FS indicates small base for 48" to 54" sided tables.
- FL indicates large base for 60" to 66" sided tables.
- For 23" deep worksurfaces, use 24" CL leg.
- For 29" and 35" deep worksurface, use 30" CL leg.
- For enhanced collision detection an Anti-Collision Desk Sensor included with every base.
- For Standard Up/Down Controller add (S) at the end of the code. For Display Controller, please add at "D" at the end of the product code and \$114 to the list price.
- Specify paint finish: BLK-Black, DWT-Designer White, TUN-Tungsten.

PRODUCT CODE	PRICE	HEIGHT MIN/MAX	WIDTH MIN/MAX	DEPTH MIN/MAX	WEIGHT LBS	VOL FT <sup>3</sup>
FT631FS24CL	4042	22.5" - 48.5"	48" - 54"	48" - 54"	59.7	4.7
FT631FS30CL	4062	22.5" - 48.5"	48" - 54"	48" - 54"	59.7	4.7
FT631FL24CL	4109	22.5" - 48.5"	60" - 66"	60" - 66"	59.7	4.7
FT631FL30CL	4129	22.5" - 48.5"	60" - 66"	60" - 66"	59.7	4.7

**FT5B2Bxx • Back-to-Back Standard Range Base**

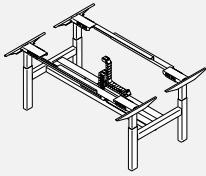

- Kit includes two beams, four cantilevers, four standard range columns and one power trough assembly with two energy chains.
- For 50.5 depth, use two x 23" deep worksurfaces.
- For 62.5" depth, use two x 29" deep worksurfaces.
- 30" or larger depth worksurfaces cannot be used with Back-to-Back bases.
- Duplex receptacles are not included, please specify separately.
- For enhanced collision detection an Anti-Collision Desk Sensor included with every base.
- For Standard Up/Down Controller add (S) at the end of the code. For Display Controller, please add at "D" at the end of the product code and \$228 to the list price.
- Specify paint finish: BLK-Black, DWT-Designer White, TUN-Tungsten.

PRODUCT CODE	PRICE	HEIGHT MIN/MAX	WIDTH MIN/MAX	DEPTH MIN/MAX	WEIGHT LBS	VOL FT <sup>3</sup>
FT5B2B48	7161	27.5" - 47"	48" - 48"	50.5" - 62.5"	129	4.7
FT5B2B54	7212	27.5" - 47"	54" - 54"	50.5" - 62.5"	129	4.7
FT5B2B60	7292	27.5" - 47"	60" - 60"	50.5" - 62.5"	129	4.7
FT5B2B66	7344	27.5" - 47"	66" - 66"	50.5" - 62.5"	129	4.7
FT5B2B72	7362	27.5" - 47"	72" - 84"	50.5" - 62.5"	129	4.7

**FT6B2Bxx • Back-to-Back Extended Range Base**

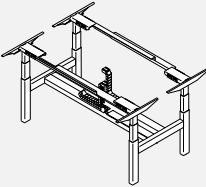

- Kit includes two beams, four cantilevers, four extended range columns and one power trough assembly with two energy chains.
- For 50.5 depth, use two x 23" deep worksurfaces.
- For 62.5" depth, use two x 29" deep worksurfaces.
- 30" or larger depth worksurfaces cannot be used with Back-to-Back bases.
- Duplex receptacles are not included, please specify separately.
- For enhanced collision detection an Anti-Collision Desk Sensor included with every base.
- For Standard Up/Down Controller add (S) at the end of the code. For Display Controller, please add at "D" at the end of the product code and \$228 to the list price.
- Specify paint finish: BLK-Black, DWT-Designer White, TUN-Tungsten.

PRODUCT CODE	PRICE	HEIGHT MIN/MAX	WIDTH MIN/MAX	DEPTH MIN/MAX	WEIGHT LBS	VOL FT <sup>3</sup>
FT6B2B48	7489	22.5" - 48.5"	48" - 48"	50.5" - 62.5"	129	4.7
FT6B2B54	7540	22.5" - 48.5"	54" - 54"	50.5" - 62.5"	129	4.7
FT6B2B60	7620	22.5" - 48.5"	60" - 60"	50.5" - 62.5"	129	4.7
FT6B2B66	7671	22.5" - 48.5"	66" - 66"	50.5" - 62.5"	129	4.7
FT6B2B72	7690	22.5" - 48.5"	72" - 84"	50.5" - 62.5"	129	4.7

**FT5SGLxxTxx • Standard Range Single Frame**

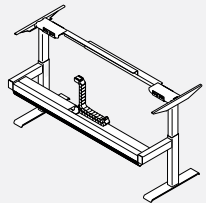

- Kit includes one beam, two cantilevers, two standard range columns, two T styled feet and one power trough assembly with one energy chains.
- For T24 leg, use 23" deep worksurfaces.
- For T30 leg, use 29" deep worksurfaces.
- 30" or larger depth worksurfaces cannot be used with Back-to-Back bases.
- Duplex receptacles are not included, please specify separately.
- For enhanced collision detection an Anti-Collision Desk Sensor included with every base.
- For Standard Up/Down Controller add (S) at the end of the code. For Display Controller, please add at "D" at the end of the product code and \$114 to the list price.
- Specify paint finish: BLK-Black, DWT-Designer White, TUN-Tungsten.

PRODUCT CODE	PRICE	HEIGHT MIN/MAX	WIDTH MIN/MAX	DEPTH MIN/MAX	WEIGHT LBS	VOL FT <sup>3</sup>
FT5SGL48T24	4197	27.5" - 47"	48" - 48"	24" - 24"	75	2.3
FT5SGL54T24	4243	27.5" - 47"	54" - 54"	24" - 24"	75	2.3
FT5SGL60T24	4301	27.5" - 47"	60" - 60"	24" - 24"	75	2.3
FT5SGL66T24	4344	27.5" - 47"	66" - 66"	24" - 24"	75	2.3
FT5SGL72T24	4378	27.5" - 47"	72" - 84"	24" - 24"	75	2.3
FT5SGL48T30	4216	27.5" - 47"	48" - 48"	30" - 30"	75	2.3
FT5SGL54T30	4263	27.5" - 47"	54" - 54"	30" - 30"	75	2.3
FT5SGL60T30	4322	27.5" - 47"	60" - 60"	30" - 30"	75	2.3
FT5SGL66T30	4363	27.5" - 47"	66" - 66"	30" - 30"	75	2.3
FT5SGL72T30	4398	27.5" - 47"	72" - 84"	30" - 30"	75	2.3

**FT6SGLxxTxx • Extended Range Single Frame**

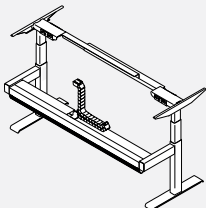

- Kit includes one beam, two cantilevers, two extended range columns, two T styled feet and one power trough assembly with one energy chains.
- For T24 leg, use 23" deep worksurfaces.
- For T30 leg, use 29" deep worksurfaces.
- 30" or larger depth worksurfaces cannot be used with Back-to-Back bases.
- Duplex receptacles are not included, please specify separately.
- For enhanced collision detection an Anti-Collision Desk Sensor included with every base.
- For Standard Up/Down Controller add (S) at the end of the code. For Display Controller, please add at "D" at the end of the product code and \$114 to the list price.
- Specify paint finish: BLK-Black, DWT-Designer White, TUN-Tungsten.

PRODUCT CODE	PRICE	HEIGHT MIN/MAX	WIDTH MIN/MAX	DEPTH MIN/MAX	WEIGHT LBS	VOL FT <sup>3</sup>
FT6SGL48T24	4361	22.5" - 48.5"	48" - 48"	24" - 24"	75	2.3
FT6SGL54T24	4408	22.5" - 48.5"	54" - 54"	24" - 24"	75	2.3
FT6SGL60T24	4465	22.5" - 48.5"	60" - 60"	24" - 24"	75	2.3
FT6SGL66T24	4508	22.5" - 48.5"	66" - 66"	24" - 24"	75	2.3
FT6SGL72T24	4541	22.5" - 48.5"	72" - 84"	24" - 24"	75	2.3
FT6SGL48T30	4381	22.5" - 48.5"	48" - 48"	30" - 30"	75	2.3
FT6SGL54T30	4427	22.5" - 48.5"	54" - 54"	30" - 30"	75	2.3
FT6SGL60T30	4485	22.5" - 48.5"	60" - 60"	30" - 30"	75	2.3
FT6SGL66T30	4528	22.5" - 48.5"	66" - 66"	30" - 30"	75	2.3
FT6SGL72T30	4561	22.5" - 48.5"	72" - 84"	30" - 30"	75	2.3

**FT5SGLxxTxx • Standard Range End-of-Run Single Frame**

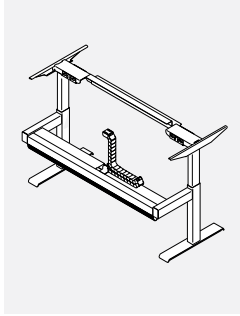

- Kit includes one beam, two cantilevers, two standard range columns, two T styled feet and one power trough assembly with one energy chains.
- For T24 leg, use 23" deep worksurfaces.
- For T30 leg, use 29" deep worksurfaces.
- 30" or larger depth worksurfaces cannot be used with Back-to-Back bases.
- Duplex receptacles are not included, please specify separately.
- For enhanced collision detection an Anti-Collision Desk Sensor included with every base.
- For Standard Up/Down Controller add (S) at the end of the code. For Display Controller, please add at "D" at the end of the product code and \$114 to the list price.
- Specify paint finish: BLK-Black, DWT-Designer White, TUN-Tungsten.

PRODUCT CODE	PRICE	HEIGHT MIN/MAX	WIDTH MIN/MAX	DEPTH MIN/MAX	WEIGHT LBS	VOL FT <sup>3</sup>
FT5SGL51T24	4575	27.5" - 47"	51" - 62"	24" - 24"	75	2.3
FT5SGL51T30	4595	27.5" - 47"	51" - 62"	30" - 30"	75	2.3

**FT6SGLxxTxx • Extended Range End-of-Run Single Frame**

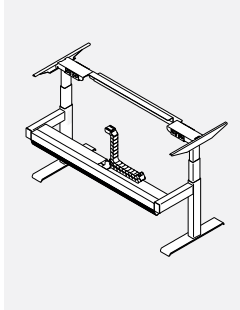

- Kit includes one beam, two cantilevers, two extended range columns, two T styled feet and one power trough assembly with one energy chains.
- For T24 leg, use 23" deep worksurfaces.
- For T30 leg, use 29" deep worksurfaces.
- 30" or larger depth worksurfaces cannot be used with Back-to-Back bases.
- Duplex receptacles are not included, please specify separately.
- For enhanced collision detection an Anti-Collision Desk Sensor included with every base.
- For Standard Up/Down Controller add (S) at the end of the code. For Display Controller, please add at "D" at the end of the product code and \$114 to the list price.
- Specify paint finish: BLK-Black, DWT-Designer White, TUN-Tungsten.

PRODUCT CODE	PRICE	HEIGHT MIN/MAX	WIDTH MIN/MAX	DEPTH MIN/MAX	WEIGHT LBS	VOL FT <sup>3</sup>
FT6SGL51T24	4739	22.5" - 48.5"	51" - 62"	24" - 24"	75	2.3
FT6SGL51T30	4759	22.5" - 48.5"	51" - 62"	30" - 30"	75	2.3

**FTM5B2BxF • Standard Range Media Table Base**

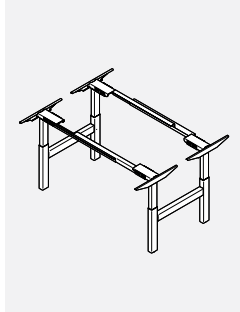

- Kit includes two beams, four cantilevers, four standard range columns and two controllers.
- SF indicates small base for 60" sided tables.
- LF indicates large base for 66" to 96" sided tables.
- Duplex receptacles are not included, please specify separately.
- For enhanced collision detection an Anti-Collision Desk Sensor included with every base.
- For Standard Up/Down Controller add (S) at the end of the code. For Display Controller, please add at "D" at the end of the product code and \$228 to the list price.
- Specify paint finish: BLK-Black, DWT-Designer White, TUN-Tungsten.

PRODUCT CODE	PRICE	HEIGHT MIN/MAX	WIDTH MIN/MAX	DEPTH MIN/MAX	WEIGHT LBS	VOL FT <sup>3</sup>
FTM5B2BSF	5852	27.5" - 47"	60" - 60"	54" - 60"	129	4.7
FTM5B2BLF	5872	27.5" - 47"	66" - 96"	54" - 60"	129	4.7

**FTM6B2BxF • Extended Range Media Table Base**

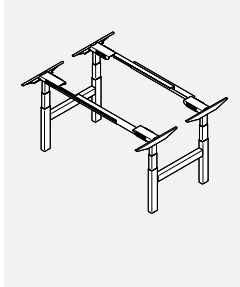

- Kit includes two beams, four cantilevers, four extended range columns and two controllers.
- SF indicates small base for 60" sided tables.
- LF indicates large base for 66" to 96" sided tables.
- Duplex receptacles are not included, please specify separately.
- For enhanced collision detection an Anti-Collision Desk Sensor included with every base.
- For Standard Up/Down Controller add (S) at the end of the code. For Display Controller, please add at "D" at the end of the product code and \$228 to the list price.
- Specify paint finish: BLK-Black, DWT-Designer White, TUN-Tungsten.

PRODUCT CODE	PRICE	HEIGHT MIN/MAX	WIDTH MIN/MAX	DEPTH MIN/MAX	WEIGHT LBS	VOL FT <sup>3</sup>
FTM6B2BSF	6180	22.5" - 48.5"	60" - 60"	54" - 60"	129	4.7
FTM6B2BLF	6198	22.5" - 48.5"	66" - 96"	54" - 60"	129	4.7

**FTWR - Rectangular Worksurface**

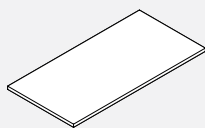

- Rectangular worksurfaces are non-handed and can be interchanged on site.
- Specify laminate finish and PVC edge finish.
- Grommet option for surfaces less than 64" is TC - Top Center only.
- Specification:
- For 23" deep worksurfaces, use FT52(S/L)F24CL/TL standard range or FT62(S/L)F24CL/TL extended range base.
- For 29" deep worksurfaces, use FT52(S/L)F30CL/TL standard range or FT62(S/L)F30CL/TL extended range base.
- For 35" deep worksurfaces, use FT5(S/L)F30CL/TL standard range or FT6(S/L)F30CL/TL extended range base.
- The 35" deep worksurfaces cannot be used with Back-to-Back Bases.
- For Back-to-Back bases, please use the following chart:  
FTW(23/29)46, FT(5/6)B2B48  
FTW(23/29)52, FT(5/6)B2B54  
FTW(23/29)58, FT(5/6)B2B60  
FTW(23/29)64, FT(5/6)B2B66  
FTW(23/29)72, FT(5/6)B2B72  
FTW(23/29)76, FT(5/6)B2B72  
FTW(23/29)82, FT(5/6)B2B72

PRODUCT CODE	FINISH		SIZE/INCHES			WEIGHT LBS	VOL FT <sup>3</sup>
	LP	HP	H	W	D		
FTWR2346	341	455	1	46	23	31	1.84
FTWR2352	401	530	1	52	23	36	2.08
FTWR2358	452	597	1	58	23	40	2.32
FTWR2364	471	622	1	64	23	44	2.56
FTWR2370	492	652	1	70	23	48	3.80
FTWR2376	529	695	1	76	23	52	3.03
FTWR2382	571	746	1	82	23	56	3.27
FTWR2946	401	530	1	46	29	40	2.32
FTWR2952	438	567	1	52	29	45	2.62
FTWR2958	471	622	1	58	29	50	2.92
FTWR2964	489	651	1	64	29	55	3.22
FTWR2970	519	687	1	70	29	60	3.52
FTWR2976	552	725	1	76	29	65	3.83
FTWR2982	615	805	1	82	29	71	4.13
FTWR3546	525	654	1	46	35	48	2.80
FTWR3552	582	729	1	52	35	54	3.16
FTWR3558	647	806	1	58	35	60	3.52
FTWR3564	706	884	1	64	35	67	3.89
FTWR3570	766	957	1	70	35	73	4.25
FTWR3576	824	1031	1	76	35	79	4.62
FTWR3582	887	1108	1	82	35	85	4.98

**FTWRR - Rectangular Return Worksurface**

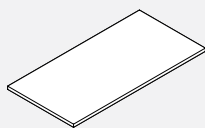

- Rectangular return worksurfaces are non-handed and can be interchanged on site.
- Specify laminate finish and PVC edge finish.
- Includes two flat brackets for connection.
- Specification:
- For 23" deep worksurfaces, use FT51SR24CL/TL standard range or FT61SR24CL/TL extended range base.
- For 29" deep worksurfaces, use FT51SR30CL/TL standard range or FT61SR30CL/TL extended range base.

PRODUCT CODE	FINISH		SIZE/INCHES			WEIGHT LBS	VOL FT <sup>3</sup>
	LP	HP	H	W	D		
FTWRR2329	206	265	1	29	23	20	1.16
FTWRR2335	228	298	1	35	23	24	1.40
FTWRR2341	295	389	1	41	23	28	1.64
FTWRR2347	352	466	1	47	23	32	1.88
FTWRR2353	412	541	1	53	23	36	2.12
FTWRR2359	463	608	1	59	23	40	2.36
FTWRR2929	239	313	1	29	29	25	1.46
FTWRR2935	280	367	1	35	29	30	1.76
FTWRR2941	393	514	1	41	29	35	2.06
FTWRR2947	412	541	1	47	29	40	2.36
FTWRR2953	449	578	1	53	29	46	2.67
FTWRR2959	482	633	1	59	29	51	2.97

**FTWR - Rectangular End-of-Run Worksurface**

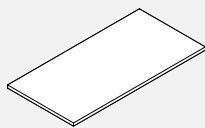

- Rectangular End-of-Run worksurfaces are non-handed and can be interchanged on site.
- Specify laminate finish and PVC edge finish.
- Specification:
- For 23" deep worksurfaces, use FT52(S/F)L24CL/TL standard range or FT62(S/F)L24CL/TL extended range base.
- For 29" deep worksurfaces, use FT52(S/F)L30CL/TL standard range or FT62(S/F)L30CL/TL extended range base.
- For Back-to-Back bases, please use the following chart:  
FTWR(23/29)51, FT(5/6)B2B60  
FTWR(23/29)62, FT(5/6)B2B66

PRODUCT CODE	FINISH		SIZE/INCHES			WEIGHT LBS	VOL FT <sup>3</sup>
	LP	HP	H	W	D		
FTWR2351	452	597	1	51	23	40	2.02
FTWR2362	471	622	1	62	23	44	2.5
FTWR2951	471	622	1	51	29	50	2.54
FTWR2962	489	651	1	62	29	55	3.15

**FTWCC - 90 Degree Corner Worksurface**

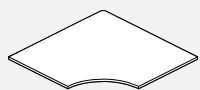

- 90 Corner Worksurface.
- Specify laminate finish and PVC edge finish.
- Specification:
- For tables that connect with 23" deep worksurfaces, use FT539FS24CL standard range or FT539FS24CL extended range base.
- For table that connect with 29" deep worksurfaces, use FT539FS30CL standard range or FT639FS30CL extended range base.

PRODUCT CODE	FINISH		SIZE/INCHES			WEIGHT LBS	VOL FT <sup>3</sup>
	LP	HP	H	W	D		
FTWCC235223	897	987	1	52	52	80	4.69
FTWCC235823	1148	1263	1	58	58	100	5.84
FTWCC294629	760	836	1	46	46	63	3.67
FTWCC295229	897	987	1	52	52	80	4.69
FTWCC295829	1148	1263	1	58	58	100	5.84

LP = Thermally Fused Laminate, HP = High Pressure Laminate.

**FTWEC - Left Extended 90 Degree Corner Worksurface**

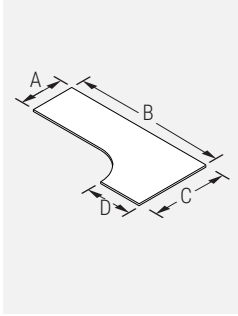

- Left Extended 90 Degree Corner Worksurface.
- Specify laminate finish and PVC edge finish.
- Specification:
- For tables that connect with 23" deep (A and D) worksurfaces, use FT539F(S/L)24CL standard range or FT639F(S/L)24CL extended range base.
- For table that connect with 29" deep (A and D) worksurfaces, use FT539F(S/L)30CL standard range or FT639F(S/L)30CL extended range base.

**NOTE: FTWEC**

A	B	C	D
DEPTH	LENGTH	WIDTH	DEPTH

PRODUCT CODE	FINISH		SIZE/INCHES			WEIGHT LBS	VOL FT <sup>3</sup>
	LP	HP	H	W	D		
FTWEC23584623	1059	1324	1	46	58	115	2.55
FTWEC23644623	1177	1472	1	46	64	127	2.81
FTWEC23704623	1288	1612	1	46	70	138	3.07
FTWEC23764623	1373	1715	1	46	76	150	3.34
FTWEC23824623	1457	1821	1	46	82	162	3.60
FTWEC23585223	1090	1364	1	52	58	130	2.88
FTWEC23645223	1211	1515	1	52	64	143	3.18
FTWEC23705223	1326	1659	1	52	70	156	3.48
FTWEC23765223	1415	1765	1	52	76	170	3.77
FTWEC23825223	1500	1876	1	52	82	183	4.07
FTWEC23645823	1248	1560	1	58	64	160	3.54
FTWEC23705823	1365	1709	1	58	70	174	3.88
FTWEC23765823	1457	1819	1	58	76	189	4.21
FTWEC23825823	1545	1932	1	58	82	204	4.54
FTWEC29584629	1059	1324	1	46	58	115	2.55
FTWEC29644629	1177	1472	1	46	64	127	2.81
FTWEC29704629	1288	1612	1	46	70	138	3.07
FTWEC29764629	1373	1715	1	46	76	150	3.34
FTWEC29824629	1457	1821	1	46	82	152	3.60
FTWEC29585229	1090	1364	1	52	58	130	2.88
FTWEC29645229	1211	1515	1	52	64	143	3.18
FTWEC29705229	1326	1659	1	52	70	156	3.48
FTWEC29765229	1415	1765	1	52	76	170	3.77
FTWEC29825229	1500	1876	1	52	82	183	4.07
FTWEC29645829	1248	1560	1	58	64	160	3.54
FTWEC29705829	1365	1709	1	58	70	174	3.88
FTWEC29765829	1457	1819	1	58	76	189	4.21
FTWEC29825829	1545	1932	1	58	82	204	4.54

**FTWEC • Right Extended 90 Degree Corner Worksurface**

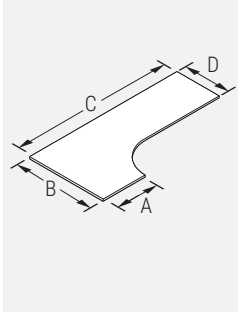

- Right Extended 90 Degree Corner Worksurface.
- Specify laminate finish and PVC edge finish.
- Specification:
- For tables that connect with 23" deep (A and D) worksurfaces, use FT539F(S/L)24CL standard range or FT539F(S/L)24CL extended range base.
- For table that connect with 29" deep (A and D) worksurfaces, use FT539F(S/L)30CL standard range or FT639F(S/L)30CL extended range base.

**NOTE: FTWEC**

A	B	C	D
DEPTH	WIDTH	LENGTH	DEPTH

PRODUCT CODE	FINISH		SIZE/INCHES			WEIGHT LBS	VOL FT <sup>3</sup>
	LP	HP	H	W	D		
FTWEC23465823	1101	1377	1	46	58	115	2.55
FTWEC23466423	1224	1529	1	46	64	127	2.81
FTWEC23467023	1338	1675	1	46	70	138	3.07
FTWEC23467623	1429	1782	1	46	76	150	3.34
FTWEC23468223	1515	1894	1	46	82	162	3.60
FTWEC23525823	1134	1418	1	52	58	130	2.88
FTWEC23526423	1261	1576	1	52	64	143	3.18
FTWEC23527023	1378	1726	1	52	70	156	3.48
FTWEC23527623	1472	1836	1	52	76	170	3.77
FTWEC23528223	1560	1950	1	52	82	183	4.07
FTWEC23586423	1299	1623	1	58	64	160	3.54
FTWEC23587023	1420	1777	1	58	70	174	3.88
FTWEC23587623	1516	1891	1	58	76	189	4.21
FTWEC23588223	1607	2009	1	58	82	204	4.54
FTWEC29465829	1101	1377	1	46	58	115	2.55
FTWEC29466429	1224	1529	1	46	64	127	2.81
FTWEC29467029	1338	1675	1	46	70	138	3.07
FTWEC29467629	1429	1782	1	46	76	150	3.34
FTWEC29468229	1515	1894	1	46	82	162	3.60
FTWEC29525829	1134	1418	1	52	58	130	2.88
FTWEC29526429	1261	1576	1	52	64	143	3.18
FTWEC29527029	1378	1726	1	52	70	156	3.48
FTWEC29527629	1472	1836	1	52	76	170	3.77
FTWEC29528229	1560	1950	1	52	82	183	4.07
FTWEC29586429	1299	1623	1	58	64	160	3.54
FTWEC29587029	1420	1777	1	58	70	174	3.88
FTWEC29587629	1516	1891	1	58	76	189	4.21
FTWEC29588229	1607	2009	1	58	82	204	4.54

LP = Thermally Fused Laminate, HP = High Pressure Laminate.

**FTWRE • Rectangular Extension Return Worksurface**

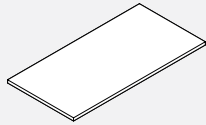

- Worksurfaces to be used only with Extended 90 Degree Corner Worksurfaces.
- Rectangular Extension Return Worksurface.
- Specify laminate finish and PVC edge finish.
- Includes 2 flat brackets for connection.
- Specification:
- FTWRE23 to be used with FTWEC23xxxx23.
- FTWRE29 to be used with FTWEC29xxxx29.

PRODUCT CODE	FINISH		SIZE / INCHES				WEIGHT LBS	VOL FT <sup>3</sup>
	LP	HP	H	W	D			
FTWRE2324	190	250	1	24	23	16	0.96	
FTWRE2330	206	265	1	30	23	20	1.20	
FTWRE2336	228	298	1	36	23	25	1.44	
FTWRE2924	225	291	1	24	29	21	1.21	
FTWRE2930	239	313	1	30	29	26	1.51	
FTWRE2936	280	367	1	36	29	31	1.81	

**FTWTC • 120 Degree Corner Worksurface**

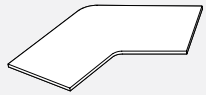

- 120 Degree Corner Worksurface.
- Specify laminate finish and PVC edge finish.
- Specification:
- For tables that connect with 23" deep (A and C) worksurfaces, use FT531F(S/L)24CL standard range or FT531F(S/L)24CL extended range base.
- For table that connect with 29" deep (A and C) worksurfaces, use FT531F(S/L)30CL standard range or FT631F(S/L)30CL extended range.

PRODUCT CODE	FINISH		SIZE / INCHES				WEIGHT LBS	VOL FT <sup>3</sup>
	LP	HP	H	W	D			
FTWTC234623	1072	1494	1	46	23	165	3.67	
FTWTC235223	1072	1494	1	52	23	211	4.69	
FTWTC235823	1926	2720	1	58	23	263	5.84	
FTWTC236423	1926	2720	1	64	23	320	7.11	
FTWTC294629	1072	1494	1	46	29	165	3.67	
FTWTC295229	1072	1494	1	52	29	211	4.69	
FTWTC295829	1926	2720	1	58	29	263	5.84	
FTWTC296429	1926	2720	1	64	29	320	7.10	

**FTWMR • Media Table Top**

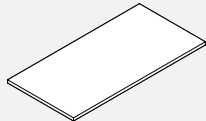

- Media Table Top.
- Specify laminate finish and PVC edge finish.
- Specification:
- For tables FTWMR5460 and 6060, use FTM5B2BSF standard range or FTM6B2BSF extended range base.
- For all other tables, use FTM5B2BLF standard range or FTM6B2BLF extended range base.

PRODUCT CODE	FINISH		SIZE / INCHES				WEIGHT LBS	VOL FT <sup>3</sup>
	LP	HP	H	W	D			
FTWMR5460	771	1068	1	60	54	96	5.63	
FTWMR5466	841	1167	1	66	54	106	6.19	
FTWMR5472	911	1268	1	72	54	115	6.75	
FTWMR5478	981	1367	1	78	54	125	7.31	
FTWMR5484	1051	1467	1	84	54	135	7.88	
FTWMR5490	1121	1567	1	90	54	144	8.44	
FTWMR5496	1191	1667	1	96	54	154	9.00	
FTWMR6060	848	1178	1	60	60	107	6.25	
FTWMR6066	924	1289	1	66	60	118	6.88	
FTWMR6072	1002	1398	1	72	60	128	7.50	
FTWMR6078	1079	1509	1	78	60	139	8.13	
FTWMR6084	1156	1619	1	84	60	150	8.75	
FTWMR6090	1232	1729	1	90	60	160	9.38	
FTWMR6096	1310	1839	1	96	60	171	10.00	

**FTMT5145 • TV Mount**

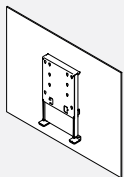

- TV Mount for FreeFit Media Tables.
- Includes the TV/Display bracket and mounting hardware.
- Maximum TV size is 50".
- Back panel is made of PET Felt.

PRODUCT CODE	FINISH	SIZE / INCHES			WEIGHT LBS	VOL FT <sup>3</sup>
		H	W	D		
FTMT5145	924	40.5	51	4	16.82	4.8

**FTBxxL • Laminate Leg Shroud for C-Leg, Left**

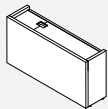

- Laminate shroud for a FreeFit C-Leg on the left side.
- Includes a felt liner at the top.
- Short side panel is removable to access interior.
- Please specify low pressure laminate, PVC edge and felt finishes.

PRODUCT CODE	FINISH LP	SIZE / INCHES			WEIGHT LBS	VOL FT <sup>3</sup>
		H	W	D		
FTB23L	720	18	23	9	47	2
FTB29L	752	18	29	9	55	3
FTB35L	784	18	35	9	67	3

LP = Thermally Fused Laminate, HP = High Pressure Laminate.



**FTBxxR • Laminate Leg Shroud for C-Leg, Right**

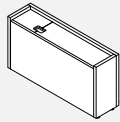

- Laminate housing to cover a FreeFit C-Leg on the right side.
- Includes a felt liner at the top.
- Short side panel is removable to access interior.
- Please specify low pressure laminate, PVC edge and felt finishes.

PRODUCT CODE	FINISH LP	SIZE/INCHES			WEIGHT LBS	VOL FT <sup>3</sup>
		H	W	D		
FTB23R	720	18	23	9	47	2
FTB29R	752	18	29	9	55	3
FTB35R	784	18	35	9	67	3

**FTBxx • Laminate Housing for T-Leg**

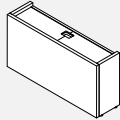

- Laminate housing to cover a FreeFit T-Leg.
- Includes a felt liner at the top.
- Short side panel is removable to access interior.
- Please specify low pressure laminate, PVC edge and felt finishes.

PRODUCT CODE	FINISH LP	SIZE/INCHES			WEIGHT LBS	VOL FT <sup>3</sup>
		H	W	D		
FTB23	720	18	23	9	47	2
FTB29	752	18	29	9	55	3
FTB35	784	18	35	9	67	3

**FTBxx • Laminate Leg Shroud for Media Bases**

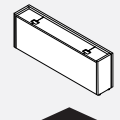

**NEW!**

- Includes a felt liner at the top.
- Side panel is removable to access the interior.
- Please specify low pressure laminate, PVC edging and felt finish.

PRODUCT CODE	FINISH LP	SIZE/INCHES			WEIGHT LBS	VOL FT <sup>3</sup>
		H	W	D		
FTB54	1168	18	54	9	110	5
FTB60	1355	18	60	9	134	6

**FTCRBFO • Credenza, Box/File / Open**

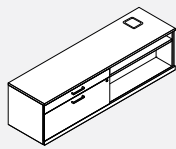

**NEW!**

- Credenza storage with grommet to accommodate a FreeFit C leg base.
- Recommended for use with the standard range bases only.
- One lock included
- One adjustable Shelf
- Select any standard Licence2 handle
- Optional E-lock available in the vertical position. Please specify V - Vertical and add \$304.00 list.
- Grommet available only in BLK - Black

PRODUCT CODE	FINISH LP	B	W	SIZE/INCHES				WEIGHT LBS	VOL FT <sup>3</sup>
				H(LP/B)	H(W)	W	D		
FTCRBFO2060	2784	3048	3156	19.94	20.5	60	20	202	20
FTCRBFO2066	2868	3155	3274	19.94	20.5	66	20	220	22
FTCRBFO2072	3018	3328	3457	19.94	20.5	72	20	254	24
FTCRBFO2460	2894	3168	3282	19.94	20.5	60	24	202	20
FTCRBFO2466	2983	3282	3406	19.94	20.5	66	24	220	22
FTCRBFO2472	3138	3462	3595	19.94	20.5	72	24	254	24

**FTCROBF • Credenza, Open / Box/File**

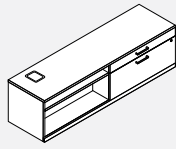

**NEW!**

- Credenza storage with grommet to accommodate a FreeFit C leg base.
- Recommended for use with the standard range bases only.
- One lock included
- One adjustable Shelf
- Select any standard Licence2 handle
- Optional E-lock available in the vertical position. Please specify V - Vertical and add \$304.00 list.
- Grommet available only in BLK - Black

PRODUCT CODE	FINISH LP	B	W	SIZE/INCHES				WEIGHT LBS	VOL FT <sup>3</sup>
				H(LP/B)	H(W)	W	D		
FTCROBF2060	2784	3048	3156	19.94	20.5	60	20	202	20
FTCROBF2066	2868	3155	3274	19.94	20.5	66	20	220	22
FTCROBF2072	3018	3328	3457	19.94	20.5	72	20	254	24
FTCROBF2460	2894	3168	3282	19.94	20.5	60	24	202	20
FTCROBF2466	2983	3282	3406	19.94	20.5	66	24	220	22
FTCROBF2472	3138	3462	3595	19.94	20.5	72	24	254	24

**FTCRBFO-T • Credenza, Box/File / Open**

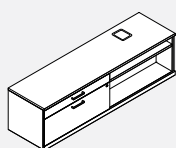

**NEW!**

- Credenza storage with grommet to accommodate a FreeFit T-leg base.
- Recommended for use with the standard range bases only.
- One lock included
- One adjustable Shelf
- Select any standard Licence2 handle
- Optional E-lock available in the vertical position. Please specify V - Vertical and add \$304.00 list.
- Grommet available only in BLK - Black

PRODUCT CODE	FINISH LP	B	W	SIZE/INCHES				WEIGHT LBS	VOL FT <sup>3</sup>
				H(LP/B)	H(W)	W	D		
FTCRBFO2060T	2784	3048	3156	19.94	20.5	60	20	202	20
FTCRBFO2066T	2868	3155	3274	19.94	20.5	66	20	220	22
FTCRBFO2072T	3018	3328	3457	19.94	20.5	72	20	254	24
FTCRBFO2460T	2894	3168	3282	19.94	20.5	60	24	202	20
FTCRBFO2466T	2983	3282	3406	19.94	20.5	66	24	220	22
FTCRBFO2472T	3138	3462	3595	19.94	20.5	72	24	254	24

**FTCROBF-T • Credenza, Open / Box/File**

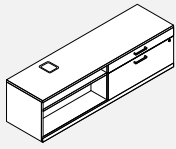

**NEW!**

- Credenza storage with grommet to accommodate a FreeFit T-leg base.
- Recommended for use with the standard range bases only.
- One lock included
- One adjustable Shelf
- Select any standard Licence2 handle
- Optional E-lock available in the vertical position. Please specify V - Vertical and add \$304.00 list.
- Grommet available only in BLK - Black

PRODUCT CODE	FINISH LP	B	W	SIZE/INCHES				WEIGHT LBS	VOL FT <sup>3</sup>
				H(LP/B)	H(W)	W	D		
FTCROBF2060T	2784	3048	3156	19.94	20.5	60	20	202	20
FTCROBF2066T	2868	3155	3274	19.94	20.5	66	20	220	22
FTCROBF2072T	3018	3328	3457	19.94	20.5	72	20	254	24
FTCROBF2460T	2894	3168	3282	19.94	20.5	60	24	202	20
FTCROBF2466T	2983	3282	3406	19.94	20.5	66	24	220	22
FTCROBF2472T	3138	3462	3595	19.94	20.5	72	24	254	24

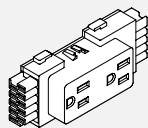
**BRT8D • Duplex Receptacles**

- Snaps into Power Distribution Housing.
- Up to 6 duplex receptacles per circuit.
- xxxD1 = Circuit #1 (utility circuit)
- xxxD2 = Circuit #2 (utility circuit)
- xxxD3 = Circuit #3 (utility circuit)
- xxxDA - Circuit #A (dedicated circuit)
- XW identifies white color plastic, all others in standard black.

PRODUCT CODE	PRICE	SIZE/INCHES			WEIGHT VOL	
		H	W	D	LBS	FT <sup>3</sup>
BRT8D1	42	2	4.625	1.25	0.10	0.01
BRT8D2	42	2	4.625	1.25	0.10	0.01
BRT8D3	42	2	4.625	1.25	0.10	0.01
BRT8DA	42	2	4.625	1.25	0.10	0.01
BRT8DXW1	56	2	4.625	1.25	0.10	0.01
BRT8DXW2	56	2	4.625	1.25	0.10	0.01
BRT8DXW3	56	2	4.625	1.25	0.10	0.01
BRT8DXWA	56	2	4.625	1.25	0.10	0.01

**GAADG • Access Door Module**

- Soft close door is set back from edge to allow for cable pass thru.
- Available in all standard panel frame finishes.
- GAADGDH includes device holder for most mobile phones or tablets. Holder is only available in white.
- FreeFit can only accommodate one grommet per worksurface.

PRODUCT CODE	PRICE	SIZE/INCHES			WEIGHT VOL	
		H	D	W	LBS	FT <sup>3</sup>
GAADG	76	1.08	5.54	10.09	2	0.04
GAADGDH	77	1.08	5.54	10.09	2	0.04

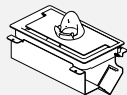
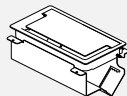
**GAADCT • Access Door Module With Cable Tray**

- Soft close door is set back from edge to allow for cable pass thru when closed.
- Cable tray comes one standard telecom knock out and a platform to mount a powerbar.
- Sides are open for easy access.
- Available in all standard panel frame finishes.
- GAADCTDH includes device holder for most mobile phones or tablets. Holder is only available in white.
- FreeFit can only accommodate one grommet per worksurface.

PRODUCT CODE	PRICE	SIZE/INCHES			WEIGHT VOL	
		H	D	W	LBS	FT <sup>3</sup>
GAADCT	115	5.07	5.54	10.09	4	0.19
GAADCTDH	122	5.07	5.54	10.09	4	0.19

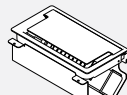
**GAADCTPD • Access Door Module With Cable Tray and Power Bar**

- Powerbar with 3 simplex and 2 USB, CSA Certified.
- Soft close door is set back from edge to allow for cable pass thru when closed.
- Cable tray comes one standard telecom knock out and a platform to mount a powerbar.
- Sides are open for easy access.
- Available in all standard panel frame finishes.
- GAADCTPDDH includes device holder for most mobile phones or tablets. Holder is only available in white.
- FreeFit can only accommodate one grommet per worksurface.

PRODUCT CODE	PRICE	SIZE/INCHES			WEIGHT VOL	
		H	D	W	LBS	FT <sup>3</sup>
GAADCTPD	249	6.96	5.54	10.09	4	0.20
GAADCTPDDH	254	6.96	5.54	10.09	4	0.20

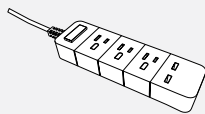
**BWAEGC00158GC • Power Bar With USB**

- Power Bar with 3 receptacles + 2 USB and power switch.
- Standard with 6' cord.
- Rating 15A, 125V, AC 60Hz, 1875W.
- USB output 5V, 2.6A (max.)
- White case, white cord.

PRODUCT CODE	PRICE	SIZE/INCHES			WEIGHT VOL	
		H	W	D	LBS	FT <sup>3</sup>
BWAEGC00158GC	86	1.3	2.3	1	1	0.02

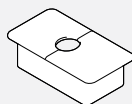
**BG5 • Rectangular Grommet**

- Option (BLK) Black Plastic
- (GRY) Grey Plastic
- (WHT) White Plastic

PRODUCT CODE	PRICE	SIZE/INCHES			WEIGHT VOL	
		H	W	D	LBS	FT <sup>3</sup>
BG5	58		3.5	2		

**MSPDM • 1 Duplex, 1 Data**

- Includes one duplex and two data jacks (both RJ45, Cat6).
- Black plastic

PRODUCT CODE	PRICE	SIZE/INCHES			WEIGHT VOL	
		H	W	D	LBS	FT <sup>3</sup>
MSPDM	355	2.75	6.5	3.5	2	0.1

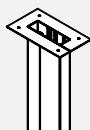
**BWAECF • Ceiling Feed Post**

- Ceiling pole brings ceiling feed conduit and data cables from the ceiling down to Power troughs height. Accommodates 9' - 3" ceiling heights.
- A two part construction allows power/data conduit lay-in.
- Includes mounting hardware and ceiling bezel.
- Painted finish.

PRODUCT CODE	PRICE	SIZE/INCHES			WEIGHT VOL	
		H	D	W	LBS	FT <sup>3</sup>
BWAECF	387	99.32	2.5	4.74	13	0.48

**BWAECFH • Ceiling Feed Harness**



- Ceiling feed provides a single power entry from ceiling, through Ceiling pole into Power Trough, into Power Distribution Housing.
- An 8-wire (4-circuit) metal conduit harness with included metal junction box for hard wiring to the building power supply above ceiling tile.
- Must be hard wired to the building power supply by a licensed electrician.
- Ceiling Pole not included.

PRODUCT CODE	PRICE	SIZE/INCHES			WEIGHT LBS	VOL FT <sup>3</sup>
		H	D	W		
BWAECFH120	493	120	6	6.00	5.00	2
BWAECFH144	549	144	6	6.00	6.00	3

**FTAEC • Table to Table Connector**

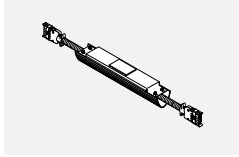

- Connects FreeFit back2back legs and trough provide power data/communication pass thru
- Connector kit consist of formed steel housing, mounting brackets,
- Housing to housing harness and one charcoal grey extruded Data/Communication cable manager
- For table to table up to 72" w (with no storage in between tables), use FTAETTC12.
- For table to table 78" w (when no storage in between), use FTAETTC18.
- For table to table 84" w (when no storage in between), use FTAETTC24.
- For table to table up to 72" w with a Pantry Storage is in between, use FTAETTC24.

PRODUCT CODE	PRICE	SIZE/INCHES			WEIGHT LBS	VOL FT <sup>3</sup>
		H	D	W		
FTAEC12	372	3	16	2.3	6.00	0.12
FTAEC18	398	3	22	2.3	8.00	0.15
FTAEC24	423	3	28	2.3	9.00	0.18
FTAEC30	446	3	34	2.3	10.60	0.22
FTAEC36	468	3	40	2.3	12.00	0.24
FTAEC42	501	3	46	2.3	11.60	0.28
FTAEC48	536	3	52	2.3	14.00	0.30

**FTABRC • Table to Boulevard Connector**

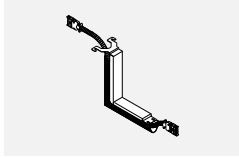

- Connects FreeFit back2back benching to a 29H table with below surface power trough.
- Please specify paint color on bracket. Wire manager is always charcoal.

PRODUCT CODE	PRICE	SIZE/INCHES			WEIGHT LBS	VOL FT <sup>3</sup>
		H	D	W		
FTABRC	314	13	13	2.3	2.4	0.28

**FTACCL • Lea Wire Manager**

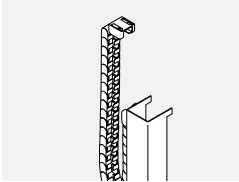

- Provides wire management from under FreeFit worksurface, down the leg and to the floor.
- Can only be used for FreeFit Regular and Media tables. Not for use on FreeFit Back-to-Back tables.
- Kit includes wire manager housing, magnets, screws and cable chain.
- Magnetically fastens to the FreeFit leg and cable chain is screwed to work surface.
- Please specify housing paint finish.

PRODUCT CODE	PRICE	SIZE/INCHES			WEIGHT LBS	VOL FT <sup>3</sup>
		H	D	W		
FTACCL	557	16	3.2	2	0.06	0.06

**FTAEFF • Floor Feed**

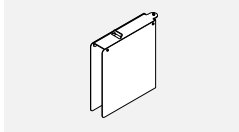

- Floor feed housing for FreeFit benching applications only
- Liquid tight whip 72"
- Must be hard wired to power source by a licenced technician
- Please choose paint color for housing.

PRODUCT CODE	PRICE	SIZE/INCHES			WEIGHT LBS	VOL FT <sup>3</sup>
		H	D	W		
FTAEFF	797	10.8	8.75	2	7	0.23

**FFTCB • Under-Worksurface Cable Basket**

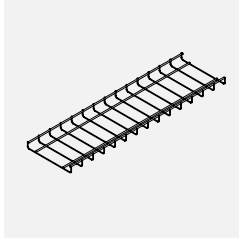

- Shallow 8" wide basket manages cable excess.
- It can be easily unclipped from steel brackets (included) to rearrange cable connections from below work surface.
- As a general rule- specify cable basket 30" shorter that the FreeFit work surface.
- Steel wire construction, black painted finish, black steel hanging brackets and fasteners.

PRODUCT CODE	PRICE	SIZE/INCHES			WEIGHT LBS	VOL FT <sup>3</sup>
		H	W	D		
FFTCB36	109	1	8	8	0.36	0.03
FFTCB48	118	1	16	8	0.73	0.07
FFTCB54	125	1	22	8	1.01	0.10
FFTCB60	133	1	28	8	1.20	0.13
FFTCB66	155	1	34	8	1.56	0.15
FFTCB72	161	1	40	8	1.80	0.18
FFTCB78	169	1	46	8	2.16	0.21
FFTCB84	179	1	52	8	2.39	0.24

**BRACS • Cable Snake**



- Flexible cable management trough.
- Two pathways within the snake, one for data/communication and one for routing power cables.
- Clear (CLR) available only.

PRODUCT CODE	PRICE	SIZE/INCHES			WEIGHT LBS	VOL FT <sup>3</sup>
		H	W	D		
BRACS	169	30	8	2	3	0.19
BRACSH	287	49	8	2	5	0.27

**FTBATT • Battery and Charger**

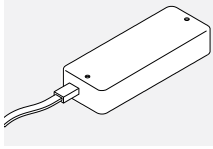

- Battery pack with charging cable mounts to the underside of the worksurface
- Features LED bars indicating capacity level and audio alarm when it needs to be charged.
- On a full charge the table can cycle from 35 to 45 stroke lengths based upon the range of column selected and load on the table.

PRODUCT CODE	PRICE	SIZE/INCHES			WEIGHT		VOL FT <sup>3</sup>
		H	D	W	LBS		
FTBATT	1235	1.5	8	3	1.54	0.02	

**FTACDS • Anti-Collision Desk Sensor USB Plug**

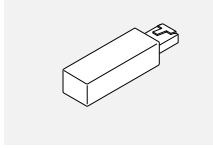

- Provides enhanced anti-collision detection.
- Plugs directly into leg column.
- Only one USB plug required for table assembly.
- This is a replacement part. The sensor ships stand with every table.

PRODUCT CODE	PRICE	SIZE/INCHES			WEIGHT		VOL FT <sup>3</sup>
		H	D	W	LBS		
FTACDS	103	0.5	2.36	0.6	0.01	0.01	

**FTDPG1C • Display + Bluetooth + Reminder Controller**

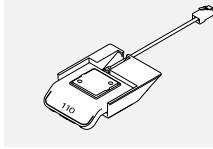

- Up/down drive with 4 memory positions.
- LED Light strip reminder, table height display.
- Bluetooth enabled connects to Desk Control App.

PRODUCT CODE	PRICE	SIZE/INCHES			WEIGHT		VOL FT <sup>3</sup>
		H	D	W	LBS		
FTDPG1C	239	1	3	4.3	0.4	0.01	

**FTDPG1M • Memory + Bluetooth + Diode Reminder Controller**

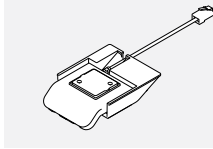

- Up/down drive with 2 memory positions.
- Bluetooth enabled connects to Desk Control App.
- This is a replacement part. Every base comes standard with a controller.

PRODUCT CODE	PRICE	SIZE/INCHES			WEIGHT		VOL FT <sup>3</sup>
		H	D	W	LBS		
FTDPG1M	97	1	3	4.3	0.4	0.01	

**FTCD2USB • Desk2Device USB Charger**

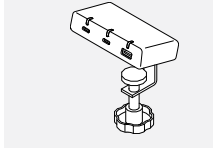

- Charge virtually any USB device directly from your FreeFit desk. Reduce cable clutter and get better power access.
- The charger is powered directly by the control box of a FreeFit table, no additional power outlet is required.
- Features one USB Type-A port (output 7.5w), two USB Type-C ports (output 50w if one port is used, 25w if both are used).
- Housing is white in color and the mounts are in black.
- Can be mounted on top of the table surface or underneath the surface (horizontal or slightly tilted).
- Includes two different mounts and a rubber (silicone) pad to secure placement on a smooth desk surface.
- Low standby power consumption of only 0.1w.
- LED diodes indicate either charging or that an active device is connected.
- PVC-Free (TM).

PRODUCT CODE	PRICE	SIZE/INCHES			WEIGHT		VOL FT <sup>3</sup>
		H	D	W	LBS		
FTCD2USB	575	0.85	3.77	1.96	0.187	0.004	

## FreeFit • Single Table; 21'-High Dividers

- FreeFit table mounted dividers for single table or single table row; recessed 6.5" at both ends (for example - 72" (70" actual) FreeFit table mounted divider measures 57").
- The center of all dividers is always mounted 2.250" from work surface's rear edge. Please note the gap between the divider and the work surface therefore varies, depending on the divider thickness (1.250" framed dividers, 0.750" frame-less LP and 0.250" frame-less glass).
- 48" (33" actual) - 66" (51" actual) dividers have 2 mounting brackets.
- 72" (57" actual) dividers have 3 mounting brackets.

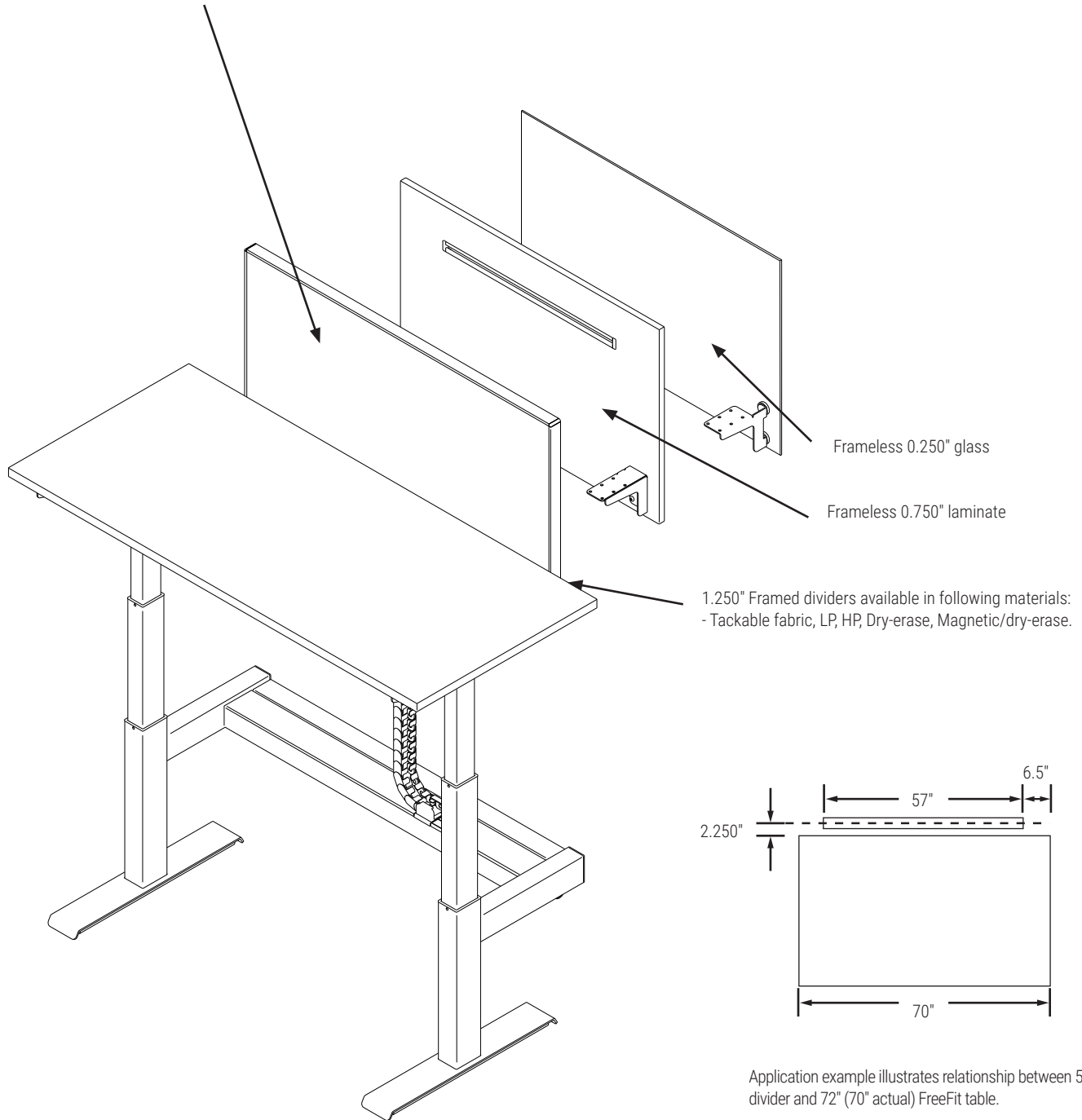

Example Order:  
 BWATMFD72  
 (actual dimension of 57") for  
 BWA2D3072A8  
 (actual dimension of 70").

**FreeFit • Back-2-Back Table; 37" High Dividers**

- FreeFit Back-2-Back stationary dividers; stationary, shared, secured to table structure; recessed 6.5" at both ends (for example - 72" (70" actual) FreeFit table mounted divider measures 57").
- The center of all dividers is always mounted 2.250" from work surface's rear edge. Please note the gap between the divider and the worksurface therefore varies, depending on the divider thickness (1.250" Framed dividers, 0.750" frame-less LP and 0.250" frame-less glass).
- 
- 48" (33" actual) divider for 48" (46" actual) table
- 54" (39" actual) divider for 54" (52" actual) table
- 60" (45" actual) divider for 60" (58" actual) table
- 66" (51" actual) divider for 66" (64" actual) table
- 72" (57" actual) divider for 72" (70" actual) table

- Framed dividers (Tackable fabric, LP, HP, Dryerase, Magnetic/dry-erase).
- Frameless LP
- Frameless glass

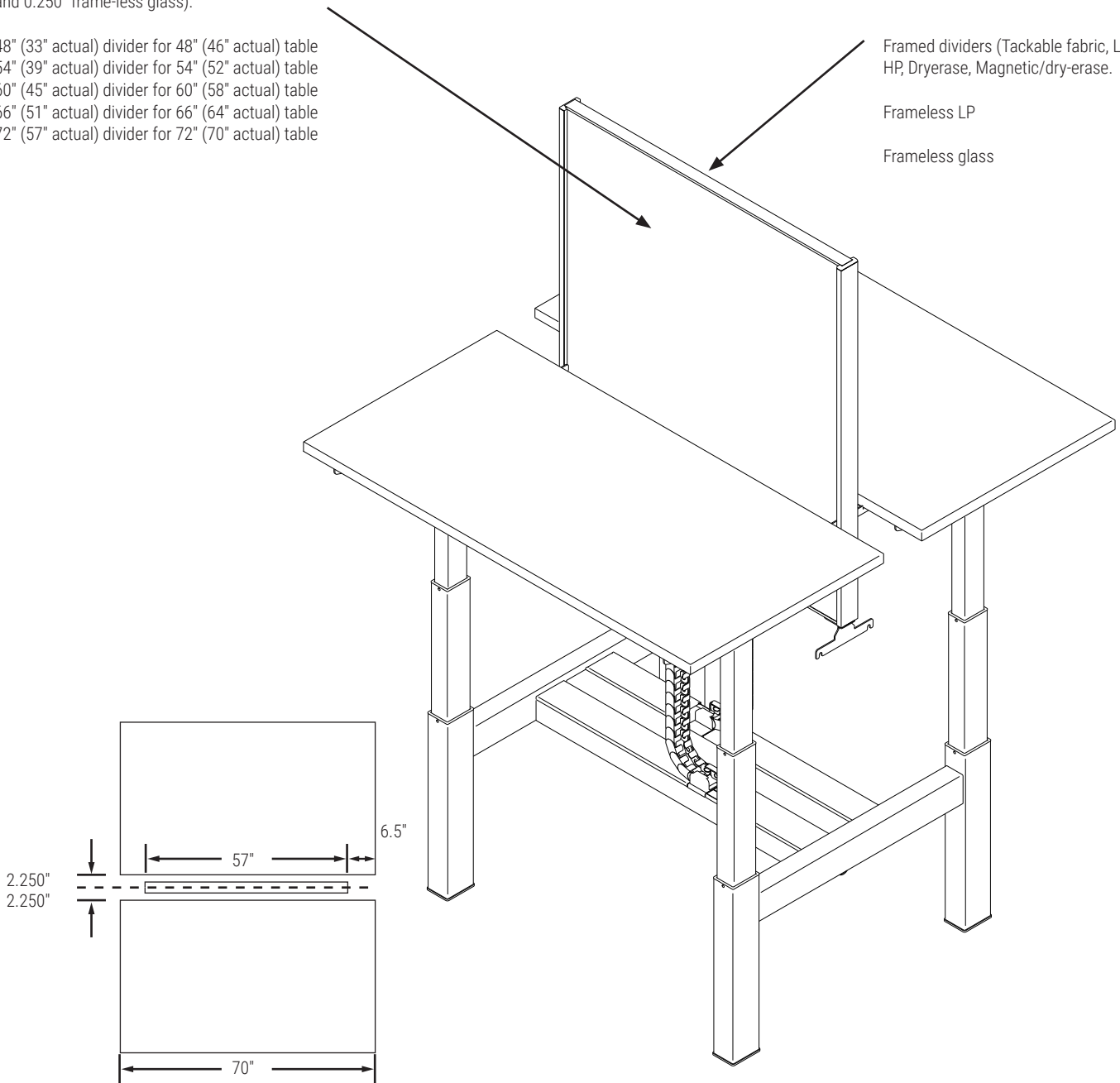

Application example illustrates relationship between 57" shared divider and 72" (70" actual) FreeFit Back-2-Back table.

Example Order:  
 BWASFD72  
 (actual dimension of 57") for  
 BWA2D6072A8  
 (actual dimension of 70").

**BWATMFD/BWATMLD • Table-Mounted Framed Dividers**

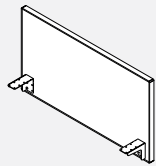

- Connects parallel on FreeFit single and back 2 back tables.
- Divider frame and connecting hardware is painted, please choose from standard metal paint finishes.
- Fabric divider is tackable.
- Divider infill can be specified in fabric, low pressure laminate (LP), high pressure laminate (HP), dry erase whiteboard (DE) or dry erase magnetic whiteboard (DM) user side only.
- Fastens to the underside of the worksurface
- 1.625" gap between worksurface and divider allows for cable pass thru
- Installed divider measures 15.7" from top of worksurface and 5.75" below the worksurface.
- 48" to 66" dividers include 2 support brackets. 72" divider includes 3 support brackets.
- When dry erase magnetic whiteboard (DM) is specified it is applied user side ONLY and dry erase whiteboard (DE) is applied on the opposite side

**TACKABLE FABRIC**

PRODUCT CODE	PRICE		SIZE/INCHES			WEIGHT		VOL FT <sup>3</sup>
	G1	G2	H	W	D	LBS		
BWATMFD48	409	453	21.5	33	1.25	16	1.23	
BWATMFD54	439	481	21.5	39	1.25	18	1.46	
BWATMFD60	476	528	21.5	45	1.25	20	1.68	
BWATMFD66	532	592	21.5	51	1.25	22	1.90	
BWATMFD72	587	647	21.5	57	1.25	26	2.13	

**LAMINATE PRODUCT**

PRODUCT CODE	PRICE				SIZE/INCHES			WEIGHT		VOL FT <sup>3</sup>
	LP	HP	DE	DM	H	W	D	LBS		
BWATMLD48	255	404	605	790	21.5	33	1.25	35	1.23	
BWATMLD54	290	481	726	964	21.5	39	1.25	39	1.46	
BWATMLD60	342	545	803	1061	21.5	45	1.25	44	1.68	
BWATMLD66	394	676	1358	1823	21.5	51	1.25	48	1.90	
BWATMLD72	429	711	1385	1848	21.5	57	1.25	52	2.13	

**BWASFD/BWASLD • Stationary Framed Dividers**

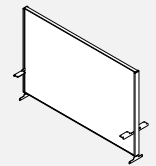

- Provides a stationary framed divider between back 2 back height-adjustable tables
- Divider frame and connecting hardware is painted, please choose from standard metal paint finishes.
- Fabric divider is tackable.
- Divider infill can be specified in fabric, low pressure laminate (LP), high pressure laminate (HP),
- Dry erase whiteboard (DE) or dry erase magnetic whiteboard (DM).
- Divider is anchored to the base and captured between two aluminum upright tracks. The uprights have sliding brackets that connect the worksurfaces to the divider providing continuous support as it travels up and down.
- 1.625" gap between worksurface and divider allows for cable pass thru
- Installed divider measures 54" from floor.

**TACKABLE FABRIC**

PRODUCT CODE	PRICE		SIZE/INCHES			WEIGHT		VOL FT <sup>3</sup>
	G1	G2	H	W	D	LBS		
BWASFD48	812	853	37.2	33	2	25	2.13	
BWASFD54	830	872	37.2	39	2	28	2.52	
BWASFD60	848	900	37.2	45	2	31	2.91	
BWASFD66	897	957	37.2	51	2	34	3.29	
BWASFD72	1162	1222	37.2	57	2	37	3.68	

**LAMINATE PRODUCT**

PRODUCT CODE	PRICE				SIZE/INCHES			WEIGHT		VOL FT <sup>3</sup>
	LP	HP	DE	DM	H	W	D	LBS		
BWASLD48	701	1086	1578	2998	37.2	33	2	58	2.13	
BWASLD54	756	1172	1678	3172	37.2	39	2	66	2.52	
BWASLD60	775	1190	1697	3191	37.2	45	2	73	2.91	
BWASLD66	815	1279	2829	5667	37.2	51	2	81	3.29	
BWASLD72	1061	1752	2998	5986	37.2	57	2	88	3.68	

**BWATMLLD • Table-Mounted Laminate Dividers**

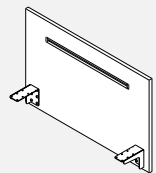

- Connects parallel on FreeFit single and back 2 back tables.
- Laminate divider with integrated accessory rail, installed one side only.
- Integrated anodized aluminum accessory rail, white cut out and rail trims; white powder coat brackets.
- 3/4" LP PVC edged boards, please specify laminate & 3mm PVC edge.
- Fastens to the underside of the worksurface.
- 1.88 gap between worksurface and divider allows for cable pass thru.
- Installed divider measures 15.7" from top of worksurface and 5.75" below the worksurface.
- 48" to 66" dividers include 2 support brackets. 72" divider includes 3 support brackets.

**LAMINATE PRODUCT**

PRODUCT CODE	PRICE		SIZE/INCHES			WEIGHT		VOL FT <sup>3</sup>
	H	W	D	LBS				
BWATMLLD48	307	21.5	33	0.75	16	1.23		
BWATMLLD54	325	21.5	39	0.75	19	1.46		
BWATMLLD60	344	21.5	45	0.75	21	1.68		
BWATMLLD66	510	21.5	51	0.75	24	1.90		
BWATMLLD72	526	21.5	57	0.75	27	2.13		

**BWASLLD • Stationary Laminate Dividers**

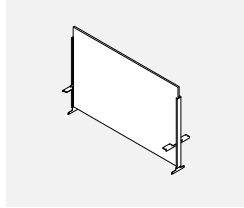

- Provides a stationary laminate divider between back 2 back height-adjustable tables
- Divider uprights and connecting hardware is painted, please choose from standard metal paint finishes.
- Please specify laminate (LP) finish.
- Divider is anchored to the base and captured between two aluminum upright tracks. The uprights have sliding brackets that connect the worksurfaces to the divider providing continuous support as it travels up and down.
- 1.88" gap between worksurface and divider allows for cable pass thru.
- Installed divider measures 54" from floor.

LAMINATE PRODUCT CODE	PRICE	SIZE/INCHES			WEIGHT LBS	VOL FT <sup>3</sup>
		H	W	D		
BWASLLD48	622	37.2	33	2	28	2.13
BWASLLD54	640	37.2	39	2	33	2.52
BWASLLD60	659	37.2	45	2	37	2.91
BWASLLD66	999	37.2	51	2	41	3.29
BWASLLD72	1018	37.2	57	2	46	3.68

**BWATMGD • Table-Mounted Glass Dividers**

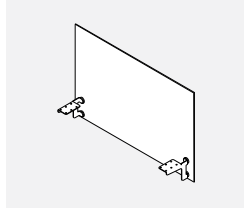

- Frameless glass divider connects parallel on single and back 2 back tables.
- Tempered glass, acid etched on one side (similar to frosted), satin chrome disc fasteners and powder coated steel support brackets.
- Fastens to the underside of the worksurface.
- 2.13 gap between worksurface and divider allows for cable pass thru.
- Installed divider measures 15.7" from top of worksurface and 4.75" below the worksurface.
- 54" to 66" dividers include 2 support brackets. 72" divider includes 3 support brackets.
- 1/2" radius on all four corners.

GLASS PRODUCT CODE	PRICE	SIZE/INCHES			WEIGHT LBS	VOL FT <sup>3</sup>
		H	W	D		
BWATMGD48	657	21.5	33	0.25	16	1.23
BWATMGD54	708	21.5	39	0.25	19	1.46
BWATMGD60	760	21.5	45	0.25	22	1.68
BWATMGD66	805	21.5	51	0.25	24	1.90
BWATMGD72	855	21.5	57	0.25	28	2.13

**BWASGD • Stationary Glass Dividers**

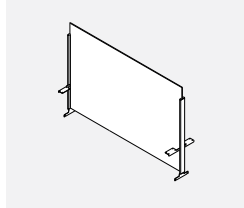

- Provides a stationary glass divider between back 2 back height-adjustable tables.
- Tempered glass, acid etched on one side (similar to frosted), satin chrome disc fasteners and white powdercoated steel support brackets.
- Divider is anchored to the base and captured between two aluminum upright tracks. The uprights have sliding brackets that connect the worksurfaces to the divider providing continuous support as it travels up and down.
- 2.13 gap between worksurface and divider allows for cable pass thru.
- 1/2" radius on top two corners.

GLASS PRODUCT CODE	PRICE	SIZE/INCHES			WEIGHT LBS	VOL FT <sup>3</sup>
		H	W	D		
BWASGD48	583	37.2	33	2	30	2.13
BWASGD54	664	37.2	39	2	34	2.52
BWASGD60	753	37.2	45	2	39	2.91
BWASGD66	833	37.2	51	2	43	3.29
BWASGD72	915	37.2	57	2	48	3.68

**BWAFWR • Felt Wrap-Around Divider for FreeFit Table**

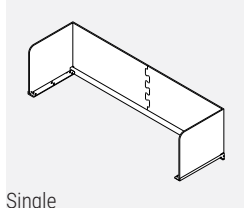

Single

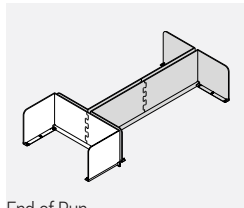

End-of-Run

- Wraps around FreeFit table to provide privacy.
- 9mm Felt material is tackable and comes in 12 different colors. Please specify color.
- Installed divider measures 15.7" high from top of the worksurface.
- Please choose standard metal finish for extrusion and brackets.
- Upcharge of \$147 for anodized extrusion option.
- Divider extends by 1.5" at the back.
- For sizes 2346, 2351 and 2352, the felt will be manufactured in one piece, while all others will be manufactured in two pieces as shown.
- Note: Cannot use ceiling feed option with this divider.

PRODUCT CODE	PRICE	SIZE/INCHES			WEIGHT LBS	VOL FT <sup>3</sup>
		H	W	D		
BWAFWR2346	528	18.24	46.84	18.46	26.58	1.07
BWAFWR2352	558	18.24	52.84	18.46	28.40	1.21
BWAFWR2358	589	18.24	58.84	18.46	30.22	1.34
BWAFWR2364	779	18.24	64.84	18.46	32.02	0.74
BWAFWR2370	832	18.24	70.84	18.46	33.84	0.81
BWAFWR2946	599	18.24	46.84	24.46	30.74	1.07
BWAFWR2952	789	18.24	52.84	24.46	32.55	0.60
BWAFWR2958	841	18.24	58.84	24.46	34.37	0.67
BWAFWR2964	894	18.24	64.84	24.46	36.19	0.74
BWAFWR2970	945	18.24	70.84	24.46	38.00	0.81
<b>End-of-Run</b>						
BWAFWR2351	535	18.24	51.34	27.94	27.94	1.05
BWAFWR2951	788	18.24	51.34	32.09	32.09	0.62
BWAFWR2363	778	18.24	63.34	31.57	31.57	1.50
BWAFWR2963	891	18.24	63.34	35.73	35.73	0.87



**BWAFPNxx • Parallel Felt Divider**

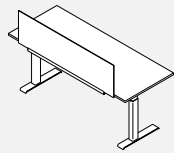

- Felt divider connects parallel on a single or Back-to-Back FreeFit table.
- 9 mm felt material is tackable and comes in a wide range of colors.
- Installed, the divider measures 15.7" high from the top of the worksurface.
- Kit includes felt divider, support extrusion and left and right brackets.
- Please choose the finish of the felt and the metal finish for the extrusion and brackets.

PRODUCT CODE	PRICE LIST	SIZE/INCHES			WEIGHT LBS	VOL FT <sup>3</sup>
		H	W	D		
BWAFPN36	198	18.24	21	5.86	2.21	1.30
BWAFPN42	222	18.24	27	5.86	2.77	1.67
BWAFPN48	280	18.24	33	5.86	2.82	2.04
BWAFPN54	313	18.24	39	5.86	3.29	2.41
BWAFPN60	356	18.24	45	5.86	3.75	2.78
BWAFPN66	501	18.24	51	5.86	4.22	3.15
BWAFPN72	534	18.24	57	5.86	4.69	3.53

**BWAFMPSNxx • Modesty Felt Divider**

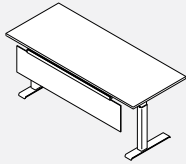

- Felt modesty panel secures to the rear bottom of a regular FreeFit table and provides privacy below the worksurface.
- 9 mm felt material is tackable and comes in a wide range of colors.
- Installed, the divider measures 15" high below the top of the worksurface.
- Kit includes felt modesty, support extrusion and left and right brackets.
- Please choose the finish of the felt and the metal finish for the extrusion and brackets.

PRODUCT CODE	PRICE LIST	SIZE/INCHES			WEIGHT LBS	VOL FT <sup>3</sup>
		H	W	D		
BWAFMPSN36	186	13.94	21	4.17	1.84	0.71
BWAFMPSN42	203	13.94	27	4.17	2.32	0.91
BWAFMPSN48	261	13.94	33	4.17	2.44	1.11
BWAFMPSN54	293	13.94	39	4.17	2.86	1.31
BWAFMPSN60	331	13.94	45	4.17	3.27	1.51
BWAFMPSN66	468	13.94	51	4.17	3.68	1.72
BWAFMPSN72	498	13.94	57	4.17	4.09	1.92

**BWAFPDNxx • Parallel Above and Below Felt Divider**

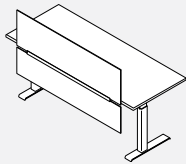

- Felt divider and modesty panel kit secures to the rear bottom of a regular FreeFit table and provides privacy above and below the worksurface.
- 9 mm felt material is tackable and comes in a wide range of colors.
- Installed, the divider measures 15.7 high from the top of the worksurface and 15" high below the top of the worksurface.
- Kit includes two felt dividers, support extrusion and left and right brackets.
- Please choose the finish of the felt and the metal finish for the extrusion and brackets.

PRODUCT CODE	PRICE LIST	SIZE/INCHES			WEIGHT LBS	VOL FT <sup>3</sup>
		H	W	D		
BWAFPDN36	293	30.68	21	5.86	2.79	2.18
BWAFPDN42	320	30.68	27	5.86	3.56	2.81
BWAFPDN48	420	30.68	33	5.86	3.82	3.43
BWAFPDN54	466	30.68	39	5.86	4.5	4.06
BWAFPDN60	543	30.68	45	5.86	5.17	4.68
BWAFPDN66	832	30.68	51	5.86	5.85	5.31
BWAFPDN72	884	30.68	57	5.86	6.53	5.93

**BWAFc • Corner Wrap Felt Divider**

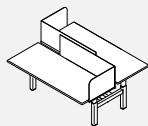
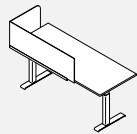

- Felt Corner Wrap secures to the side and rear bottom of a FreeFit table, wraps around one side and provides limited privacy.
- 9 mm felt material is tackable and comes in a wide range of colors.
- Installed, the divider measures 15.7 high from the top of the worksurface..
- Kit includes felt dividers, support extrusion and large and small handed brackets.
- Please choose the finish of the felt and the metal finish for the extrusion and brackets.

PRODUCT CODE	PRICE LIST	SIZE/INCHES			WEIGHT LBS	VOL FT <sup>3</sup>
		H	W	D		
BWAFc2432L	381	18.24	32.46	18.52	4.99	6.35
BWAFc2432R	381	18.24	32.46	18.52	4.99	6.35
BWAFc2438L	435	18.24	38.46	18.52	5.46	7.52
BWAFc2438R	435	18.24	38.46	18.52	5.46	7.52
BWAFc2448L	468	18.24	47.46	18.52	6.16	9.28
BWAFc2448R	468	18.24	47.46	18.52	6.16	9.28
BWAFc3032L	431	18.24	32.46	24.52	5.72	8.40
BWAFc3032R	431	18.24	32.46	24.52	5.72	8.40
BWAFc3038L	462	18.24	38.46	24.52	6.19	9.95
BWAFc3038R	462	18.24	38.46	24.52	6.19	9.95
BWAFc3048L	496	18.24	47.46	24.52	6.89	12.28
BWAFc3048R	496	18.24	47.46	24.52	6.89	12.28

**FFTDPxxxxH24 • Height-Adjustable Table Polycarbonate Divider Screen Kit, 24" High**

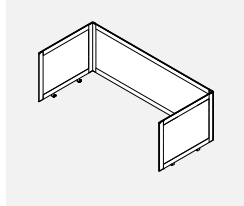

- Provides privacy in an open plan environment.
- Lightweight and easy to clean table mounted partitions.
- Consists of a powder coated aluminum frame, translucent fluted polycarbonate and all hardware to connect. Brackets are painted steel.
- Side dividers extend 6.237" from the front edge of each surface.
- Back divider extends over the back edge of the worksurface by 1 1/2" allowing for the passage of cables to the trough.
- FFTDP24xxH24 are for 23" deep surfaces and FFTDP30xxH24 are for 29" deep surfaces.
- Width and depth are nominal sizes representing the sizes of the FreeFit Table. Allow for 1/4" overhang at the sides, 1 1/2" at the back and 6.237" at the front.
- Please choose any standard paint finish from Teknion for frame and hardware. End trim cap is available only in CHR - charcoal.

PRODUCT CODE	PRICE	SIZE/INCHES			WEIGHT LBS	VOL FT <sup>3</sup>
		H	W	D		
FFTDP2436H24	897	24.63	34	31.75	26.55	3.94
FFTDP2442H24	921	24.63	40	31.75	28.10	4.59
FFTDP2448H24	945	24.63	46	31.75	29.65	5.25
FFTDP2454H24	968	24.63	42	31.75	31.20	5.91
FFTDP2460H24	993	24.63	58	31.75	32.75	6.56
FFTDP2466H24	1019	24.63	60	31.75	34.30	7.22
FFTDP2472H24	1041	24.63	70	31.75	35.85	7.88
FFTDP2478H24	1064	24.63	76	31.75	37.40	8.53
FFTDP2484H24	1112	24.63	82	31.75	38.95	9.19
FFTDP3036H24	928	24.63	34	37.75	40.50	4.72
FFTDP3042H24	952	24.63	40	37.75	42.05	5.51
FFTDP3048H24	976	24.63	46	37.75	43.60	6.29
FFTDP3054H24	1000	24.63	42	37.75	45.15	7.08
FFTDP3060H24	1024	24.63	58	37.75	46.70	7.87
FFTDP3066H24	1048	24.63	60	37.75	48.25	8.65
FFTDP3072H24	1072	24.63	70	37.75	49.80	9.44
FFTDP3078H24	1096	24.63	76	37.75	51.35	10.22
FFTDP3084H24	1144	24.63	82	37.75	52.90	11.01

**FFTDPxxxxH30 • Height-Adjustable Table Polycarbonate Divider Screen Kit, 30" High**

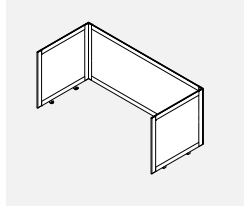

- Provides privacy in an open plan environment.
- Lightweight and easy to clean table mounted partitions.
- Consists of a powder coated aluminum frame, translucent fluted polycarbonate and all hardware to connect. Brackets are painted steel.
- Side dividers extend 6.237" from the front edge of each surface.
- Back divider extends over the back edge of the worksurface by 1 1/2" allowing for the passage of cables to the trough.
- FFTDP24xxH24 are for 23" deep surfaces and FFTDP30xxH24 are for 29" deep surfaces.
- Width and depth are nominal sizes representing the sizes of the FreeFit Table. Allow for 1/4" overhang at the sides, 1 1/2" at the back and 6.237" at the front.
- Please choose any standard paint finish from Teknion for frame and hardware. End trim cap is available only in CHR - charcoal.

PRODUCT CODE	PRICE	SIZE/INCHES			WEIGHT LBS	VOL FT <sup>3</sup>
		H	W	D		
FFTDP2436H30	891	30.63	34	31.75	26.55	3.94
FFTDP2442H30	913	30.63	40	31.75	28.10	4.59
FFTDP2448H30	935	30.63	46	31.75	29.65	5.25
FFTDP2454H30	957	30.63	42	31.75	31.20	5.91
FFTDP2460H30	979	30.63	58	31.75	32.75	6.56
FFTDP2466H30	1002	30.63	60	31.75	34.30	7.22
FFTDP2472H30	1024	30.63	70	31.75	35.85	7.88
FFTDP2478H30	1046	30.63	76	31.75	37.40	8.53
FFTDP2484H30	1100	30.63	82	31.75	38.95	9.19
FFTDP3036H30	934	30.63	34	37.75	40.50	4.72
FFTDP3042H30	956	30.63	40	37.75	42.05	5.51
FFTDP3048H30	978	30.63	46	37.75	43.60	6.29
FFTDP3054H30	1000	30.63	42	37.75	45.15	7.08
FFTDP3060H30	1024	30.63	58	37.75	46.70	7.87
FFTDP3066H30	1046	30.63	60	37.75	48.25	8.65
FFTDP3072H30	1068	30.63	70	37.75	49.80	9.44
FFTDP3078H30	1090	30.63	76	37.75	51.35	10.22
FFTDP3084H30	1142	30.63	82	37.75	52.90	11.01

**FFTDGxxxxH24 • Height-Adjustable Table Glass Divider Screen Kit, 24" High**

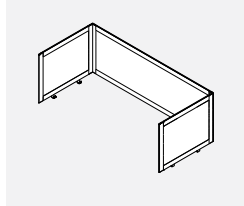

- Provides privacy in an open plan environment.
- Easy to clean table mounted partitions.
- Consists of a powder coated aluminum frame, 4mm clear (CLR) glass and all hardware to connect. Brackets are painted steel.
- Side dividers extend 6.237" from the front edge of each surface.
- Back divider extends over the back edge of the worksurface by 1 1/2" allowing for the passage of cables to the trough.
- FFTDG24xxH24 are for 23" deep surfaces and FFTDG30xxH24 are for 29" deep surfaces.
- Width and depth are nominal sizes representing the sizes of the FreeFit Table. Allow for 1/4" overhang at the sides, 1 1/2" at the back and 6.237" at the front.
- Please choose any standard paint finish from Teknion for frame and hardware. End trim cap is available only in CHR - charcoal.
- Upcharge for frosted (FRST) glass is 20%.

PRODUCT CODE	PRICE	SIZE/INCHES			WEIGHT LBS	VOL FT <sup>3</sup>
		H	W	D		
FFTDG2436H24	1380	24.60	34	31.50	26.55	3.94
FFTDG2442H24	1425	24.60	40	31.50	28.10	4.59
FFTDG2448H24	1470	24.60	46	31.50	29.65	5.25
FFTDG2454H24	1515	24.60	42	31.50	31.20	5.91
FFTDG2460H24	1560	24.60	58	31.50	32.75	6.56
FFTDG2466H24	1605	24.60	60	31.50	34.30	7.22
FFTDG2472H24	1651	24.60	70	31.50	35.85	7.88
FFTDG2478H24	1696	24.60	76	31.50	37.40	8.53
FFTDG2484H24	1742	24.60	82	31.50	38.95	9.19
FFTDG3036H24	1466	24.60	34	37.75	40.50	4.72
FFTDG3042H24	1511	24.60	40	37.75	42.05	5.51
FFTDG3048H24	1556	24.60	46	37.75	43.60	6.29
FFTDG3054H24	1601	24.60	42	37.75	45.15	7.08
FFTDG3060H24	1647	24.60	58	37.75	46.70	7.87
FFTDG3066H24	1691	24.60	60	37.75	48.25	8.65
FFTDG3072H24	1737	24.60	70	37.75	49.80	9.44
FFTDG3078H24	1782	24.60	76	37.75	51.35	10.22
FFTDG3084H24	1828	24.60	82	37.75	52.90	11.01

**FFTDGxxxxH30 • Height-Adjustable Table Glass Divider Screen Kit, 30" High**

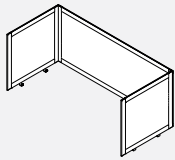

- Provides privacy in an open plan environment.
- Easy to clean table mounted partitions.
- Consists of a powder coated aluminum frame, 4mm clear (CLR) glass and all hardware to connect. Brackets are painted steel.
- Side dividers extend 6.237" from the front edge of each surface.
- Back divider extends over the back edge of the worksurface by 1 1/2" allowing for the passage of cables to the trough.
- FTDG24xxH30 are for 23" deep surfaces and FTDG30xxH30 are for 29" deep surfaces.
- Width and depth are nominal sizes representing the sizes of the FreeFit Table. Allow for 1/4" overhang at the sides, 1 1/2" at the back and 6.237" at the front.
- Please choose any standard paint finish from Teknion for frame and hardware. End trim cap is available only in CHR - charcoal.
- Upcharge for frosted (FRST) glass is 20%.

PRODUCT CODE	PRICE	SIZE/INCHES			WEIGHT LBS	VOL FT <sup>3</sup>
		H	W	D		
FFTDG2436H30	1445	30.60	34	31.50	28.85	3.94
FFTDG2442H30	1491	30.60	40	31.50	30.40	4.59
FFTDG2448H30	1538	30.60	46	31.50	31.95	5.25
FFTDG2454H30	1585	30.60	42	31.50	33.50	5.91
FFTDG2460H30	1632	30.60	58	31.50	35.05	6.56
FFTDG2466H30	1679	30.60	60	31.50	36.60	7.22
FFTDG2472H30	1706	30.60	70	31.50	38.15	7.88
FFTDG2478H30	1772	30.60	76	31.50	39.70	8.53
FFTDG2484H30	1819	30.60	82	31.50	41.25	9.19
FFTDG3036H30	1537	30.60	34	37.75	42.80	4.72
FFTDG3042H30	1583	30.60	40	37.75	44.35	5.51
FFTDG3048H30	1630	30.60	46	37.75	45.90	6.29
FFTDG3054H30	1678	30.60	42	37.75	47.45	7.08
FFTDG3060H30	1725	30.60	58	37.75	49.00	7.87
FFTDG3066H30	1771	30.60	60	37.75	50.55	8.65
FFTDG3072H30	1798	30.60	70	37.75	52.10	9.44
FFTDG3078H30	1864	30.60	76	37.75	53.65	10.22
FFTDG3084H30	1911	30.60	82	37.75	55.20	11.01

**FFTDFxxxxH24 • Height-Adjustable Table Felt Divider Screen Kit, 24" High**

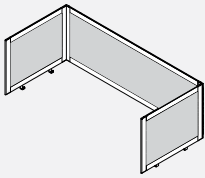

- Provides privacy in an open plan environment.
- Consists of a powder coated aluminum frame, 9mm felt and all hardware to connect. Brackets are painted steel.
- Side dividers extend 6.237" from the front edge of each surface.
- Back divider extends over the back edge of the worksurface by 1 1/2" allowing for the passage of cables to the trough.
- FFTDF24xxH24 are for 23" deep surfaces and FFTDF30xxH24 are for 29" deep surfaces.
- Width and depth are nominal sizes representing the sizes of the FreeFit Table. Allow for 1/4" overhang at the sides, 1 1/2" at the back and 6.237" at the front.
- Please choose any standard paint finish from Teknion for frame and hardware. Select also a felt finish. End trim cap is available only in CHR - charcoal.
- 9mm felt material is tackable and comes in a variety of colors.

PRODUCT CODE	PRICE	SIZE/INCHES			WEIGHT LBS	VOL FT <sup>3</sup>
		H	W	D		
FFTDF2436H24	897	24.60	34	31.50	22.55	3.94
FFTDF2442H24	921	24.60	40	31.50	24.10	4.59
FFTDF2448H24	945	24.60	46	31.50	25.65	5.25
FFTDF2454H24	968	24.60	42	31.50	27.20	5.91
FFTDF2460H24	992	24.60	58	31.50	28.75	6.56
FFTDF2466H24	1016	24.60	60	31.50	30.30	7.22
FFTDF2472H24	1040	24.60	70	31.50	31.85	7.80
FFTDF2478H24	1064	24.60	76	31.50	33.40	8.53
FFTDF2484H24	1112	24.60	82	31.50	34.95	9.19
FFTDF3036H24	928	24.60	34	37.75	36.50	4.72
FFTDF3042H24	952	24.60	40	37.75	38.05	5.51
FFTDF3048H24	976	24.60	46	37.75	39.60	6.29
FFTDF3054H24	1000	24.60	42	37.75	41.15	7.08
FFTDF3060H24	1024	24.60	58	37.75	41.70	7.87
FFTDF3066H24	1048	24.60	60	37.75	44.25	8.65
FFTDF3072H24	1072	24.60	70	37.75	45.80	9.44
FFTDF3078H24	1095	24.60	76	37.75	47.35	10.22
FFTDF3084H24	1143	24.60	82	37.75	48.90	11.01

**FFTDFxxxxH30 - Height-Adjustable Table Felt Divider Screen Kit, 30" High**

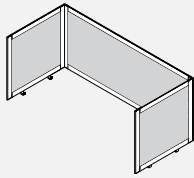

- Provides privacy in an open plan environment.
- Consists of a powder coated aluminum frame, 9mm felt and all hardware to connect. Brackets are painted steel.
- Side dividers extend 6.237" from the front edge of each surface.
- Back divider extends over the back edge of the worksurface by 1 1/2" allowing for the passage of cables to the trough.
- FFTDF24xxH30 are for 23" deep surfaces and FFTDF30xxH30 are for 29" deep surfaces.
- Width and depth are nominal sizes representing the sizes of the FreeFit Table. Allow for 1/4" overhang at the sides, 1 1/2" at the back and 6.237" at the front.
- Please choose any standard paint finish from Teknion for frame and hardware. Select also a felt finish. End trim cap is available only in CHR - charcoal.
- 9mm felt material is tackable and comes in a variety of colors.

PRODUCT CODE	PRICE	SIZE/INCHES			WEIGHT LBS	VOL FT <sup>3</sup>
		H	W	D		
FFTDF2436H30	891	30.60	34	31.50	24.85	3.94
FFTDF2442H30	913	30.60	40	31.50	26.40	4.59
FFTDF2448H30	935	30.60	46	31.50	27.95	5.25
FFTDF2454H30	957	30.60	42	31.50	29.50	5.91
FFTDF2460H30	979	30.60	58	31.50	31.05	6.56
FFTDF2466H30	1002	30.60	60	31.50	32.60	7.22
FFTDF2472H30	1024	30.60	70	31.50	34.15	7.88
FFTDF2478H30	1046	30.60	76	31.50	35.70	8.53
FFTDF2484H30	1099	30.60	82	31.50	37.25	9.19
FFTDF3036H30	933	30.60	34	37.75	38.80	4.72
FFTDF3042H30	956	30.60	40	37.75	40.35	5.51
FFTDF3048H30	978	30.60	46	37.75	41.90	6.29
FFTDF3054H30	1000	30.60	42	37.75	43.45	7.08
FFTDF3060H30	1024	30.60	58	37.75	45.00	7.87
FFTDF3066H30	1046	30.60	60	37.75	46.55	8.65
FFTDF3072H30	1068	30.60	70	37.75	48.10	9.44
FFTDF3078H30	1090	30.60	76	37.75	49.65	10.22
FFTDF3084H30	1142	30.60	82	37.75	51.20	11.01

**FTATB • Boulevard Connector Kit**

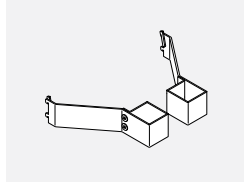

- FreeFit to Boulevard kit secures FreeFit height-adjustable freestanding tables to parallel Boulevard panels.
- It provides panel/table alignment, preventing moving parts from rubbing against panel vertical surfaces and maintains 1" clearance around table surface perimeter.
- Standard metal finishes.
- All hardware included.
- Sold as a pair.
- Note: - Kit connects to C style base only.

PRODUCT CODE	PRICE	SIZE/INCHES			WEIGHT VOL	
		H	W	D	LBS	FT <sup>3</sup>
FTATB	194	10	6.5	10	7.00	0.50

**FTAEG • Back-to-Back End Gable**

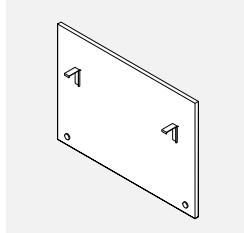

- Optional Back-to-Back FreeFit End Gable is intended to be installed at the end of FreeFit Back-to-Back table run.
- Made out of 3/4" PL Laminated, it enhances FreeFit table assembly aesthetics by reducing number of visible elements below work surface.
- Two heights available.
- The End Gable connects to FreeFit H-frame crossbar; compatible with Floor Feed.
- Please specify LP finish.
- Please specify paint finish for the brackets.

PRODUCT CODE	PRICE	SIZE/INCHES			WEIGHT VOL	
		H	D	W	LBS	FT <sup>3</sup>
FTAEG18H	433	18	30	0.75	10.00	0.24
FTAEG22H	468	23	30	0.75	13.00	0.30

**FTACPU • CPU Holder**

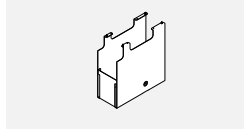

- Accepts tower CPU's with a width range from 7.6" to 2.25" and a maximum height of 18"
- Durable sheet metal construction
- Please specify paint finish.

PRODUCT CODE	PRICE	SIZE/INCHES			WEIGHT VOL	
		H	D	W	LBS	FT <sup>3</sup>
FTACPU	403	21	21	8	3.57	2.04

**BRTLCS • Locking Caster for Rectangular Leg Tables**

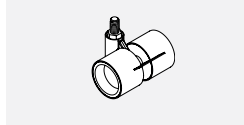

- Locking Caster for Rectangular Table.
- 40mm dia. locking caster with 8mm thread; whitebody, light grey tires.

PRODUCT CODE	PRICE	SIZE/INCHES			WEIGHT VOL	
		H	D	W	LBS	FT <sup>3</sup>
BRTLCS	33	2.5	2.7	2.6	0.06	0.01

**FTFOOTxxTL • T-foot**

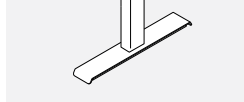

- Replacement single "T" foot.
- Includes attachment hardware.

PRODUCT CODE	PRICE	SIZE/INCHES			WEIGHT VOL	
		H	D	W	LBS	FT <sup>3</sup>
FTFOOT24TL	136	1.16	23	3	4.4	0.25
FTFOOT30TL	144	1.16	29	3	4.85	0.31

**FTFOOTxxCL - C-foot**

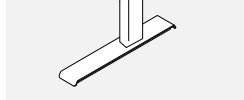

- Replacement single "C" foot.
- Includes attachment hardware.

PRODUCT CODE	PRICE	SIZE/INCHES			WEIGHT VOL	
		H	D	W	LBS	FT <sup>3</sup>
FTFOOT24CL	160	1.16	23	3	4.4	0.25
FTFOOT30CL	167	1.16	29	3	4.85	0.31

**FTSETGLIDE • Set of Glides**

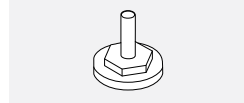

- Replacement Glides a set of two with 1/2" adjustment

PRODUCT CODE	PRICE	SIZE/INCHES			WEIGHT VOL	
		H	D	W	LBS	FT <sup>3</sup>
FTSETGLIDE	15	1	1.5	1.5	0.06	0.01

**BRLBST • Single Table Accessory Rail**

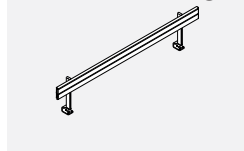

- Table mounted accessory rail.
- Compatible with standard Bins, Trays and Sorters.
- Includes end caps and mounting hardware.
- Please specify paint finish
- To ensure proper connection and clearance on tables 46" wide and up, choose accessory rail 13" smaller than the actual table width (70" wide table gets 57" wide rail).
- Tables 40" wide and smaller use 33" wide accessory rail.

PRODUCT CODE	PRICE	SIZE/INCHES			WEIGHT VOL	
		H	W	D	LBS	FT <sup>3</sup>
BRLBST36	366	16	33	2.95	5.9	0.26
BRLBST42	384	16	39	2.95	6.44	0.30
BRLBST48	398	16	45	2.95	6.98	0.35
BRLBST54	412	16	51	2.95	7.52	0.39
BRLBST60	423	16	57	2.95	8.07	0.43
BRLBST66	437	16	63	2.95	8.61	0.48
BRLBST72	452	16	69	2.95	9.15	0.52
BRLBST78	465	16	75	2.95	9.69	0.56
BRLBST84	480	16	81	2.95	10.24	0.61

**GCBMSG • Board-Mounted Wellness Screen**

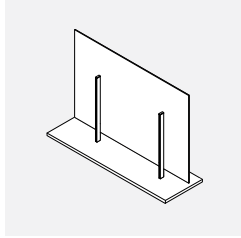

- Surface mounted wellness screen provides a physical divider.
- Choose LP (low pressure laminate color).
- Acrylic glazing is clear and support rails are painted DWT Designer White.
- Kit includes all hardware to assemble and place on top of a surface.
- Actual height of the acrylic is 31.5", screws will allow acrylic to be installed at any height along the vertical rails to allow a 1/2" to 10" gap.

PRODUCT CODE	PRICE	SIZE/INCHES			WEIGHT VOL	
		H	W	D	LBS	FT <sup>3</sup>
GCBMSG3636LP	611	36	36	12	28.45	2.92
GCBMSG3648LP	787	36	48	12	34.17	3.98

**GCAMSG • Wellness Screen Only, for Use With Existing Worksurface or Transaction Top**

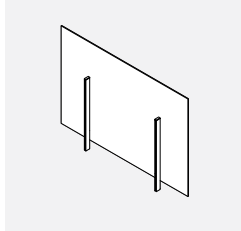

- Surface mounted wellness screen provides a physical divider.
- Acrylic glazing is clear and support rails are painted DWT Designer White.
- Kit includes all hardware to install on an existing surface.
- Actual height of the acrylic is 31.5", screws will allow acrylic to be installed at any height along the vertical rails to allow a 1/2" to 10" gap.

PRODUCT CODE	PRICE	SIZE/INCHES			WEIGHT VOL	
		H	W	D	LBS	FT <sup>3</sup>
GCAMSG3636LP	458	36	36	2	20.2	2.92
GCAMSG3648LP	527	36	48	2	22.8	3.98

**GCBRMSG • Wellness Screen With Surface Mounting Bracket, For Use With Existing Worksurface or Transaction Topface or Transaction Top**

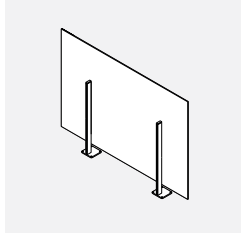

- Surface mounted wellness screen provides a physical divider.
- Acrylic glazing is clear and support rails are painted DWT Designer White.
- Kit includes all hardware to install on an existing surface.
- Actual height of the acrylic is 31.5", screws will allow acrylic to be installed at any height along the vertical rails to allow 1/2" to 10" gap.

PRODUCT CODE	PRICE	SIZE/INCHES			WEIGHT VOL	
		H	W	D	LBS	FT <sup>3</sup>
GCBRMSG3636LP	550	36	36	5	20.2	2.92
GCBRMSG3648LP	687	36	48	5	22.8	3.98

**GCTCSG • Wellness Screen With Clamp Mount Bracket, for Use With Existing Worksurface or Transaction Top**

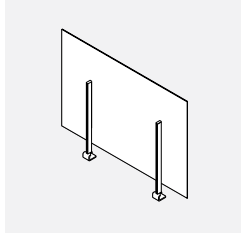

- Surface mounted wellness screen provides a physical divider.
- Acrylic glazing is clear and support rails are painted DWT Designer White.
- Kit includes all hardware to install on an existing surface.
- Actual height of the acrylic is 31.5", screws will allow acrylic to be installed at any height along the vertical rails to allow 1/2" to 10" gap.
- LP code indicated dividers will fit on 1" thick surfaces, where the W code will fit on 1 1/2" thick surfaces.

PRODUCT CODE	PRICE	SIZE/INCHES			WEIGHT VOL	
		H	W	D	LBS	FT <sup>3</sup>
GCTCSG3636LP	551	36	36	3	20.2	2.92
GCTCSG3648LP	687	36	48	3	22.8	3.98
GCTCSG3636W	566	36	36	3	20.2	2.92
GCTCSG3648W	702	36	48	3	22.8	3.98

**L2RSB • Screening Booth**

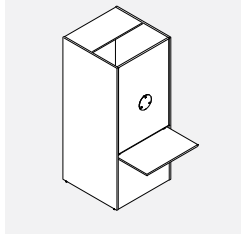

- Screening Booth is ideal for hospitals, clinics, reception areas or anywhere a safe self-contained environment is required.
- Screening Booth has a protected speaker hold, a paper space above the work surface, a interior and exterior work surface.
- The gap between the work surface and glazed frame can be changed during assembly from 1.5" to 4" based on the direction of the screen.
- Booth available in DWTL - Designer White only.
- Can be closed or connected with Diet Laminate Panels.
- Ships knocked down.

PRODUCT CODE	PRICE	SIZE/INCHES			WEIGHT VOL	
		H	W	D	LBS	FT <sup>3</sup>
L2RSB	3266	82	36	36	238.81	61.50

**L2SBCF • Screening Booth Ceiling Feed Pole**

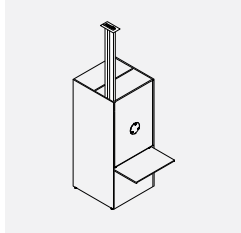

- Screening Booth Ceiling Pole can be used to bring power and/or data from the ceiling to the Booth.
- Aluminum extrusion comes in powder coated paint finish, DWT - Designer White or TUN - Tungsten.
- Kit includes aluminum extrusions, spacer, trim kit and double-sided adhesive tape.
- Maximum ceiling height of 108".

PRODUCT CODE	PRICE	SIZE/INCHES			WEIGHT VOL	
		H	W	D	LBS	FT <sup>3</sup>
L2SBCF	184	76.5	4.5	1.5	8.69	0.29





# teknion

[www.teknion.com](http://www.teknion.com)

CAN/US/INT 05-27  
© Teknion 2024

°, ™ trademarks of Teknion Corporation  
and/or its subsidiaries or licensed to it.  
Patents may be pending.

Some products may not be available in  
all markets. Contact your local Teknion  
Representative for availability.

JUNE24-BLVD