

**LICENCE 2 SPECIFICATIONS**

- Greenguard certified (www.greenguard.org)
- Carb compliant
- Level3™ certified (www.levelcertified.org)
- Tested to meet or exceed ANSI/BIFMA X5.9.2004 , ANSI/BIFMA X5.5.2008 and CAN/CGSB 44-227-2008
- Plant is ISO 9001:2015 (Quality) certified
- Plant is ISO 14001: 2015 (Environmental) certified
- Plant is OHSAS 18001:2007 (Health and Safety) certified
- 100% made in Canada
- Lifetime Warranty
- Over 6500 standard components
- Custom units available in 5 weeks lead time
- Over 24 standard laminate finishes available
- Edge color can be specified - select from 20 colors and patterns
- Desk shells and rectangular returns non handed
- Panel end style with top over side panel design
- Tops available in 1" thick Low Pressure Laminate
- Tops available in 1-1/16" or 1-7/16" thick High Pressure Laminate
- Tops available in one edge style: Boulevard (S)
- Surfaces constructed of 45lb. density particleboard substructure with high performance thermally fused laminate or optional high pressure laminate
- Chassis constructed from 45lb. density particleboard substructure with thermally fused laminate
- 3mm edges surround all tops, end panels, drawers and door fronts
- Laminate full modesty and 10" partial modesty available as standard
- Anodized Aluminum framed frosted glazed doors available, no handles included.
- Box drawers mounted on full extension premium ball bearing slides
- File drawers mounted on premium full extension progressive ball bearing slides
- File drawers accommodate letter and/or legal hanging files (see file drawer capacity page G.2)
- Locks are standard on all units. Available in black or silver finish
- All lateral files feature a drawer interlocking mechanism
- Desk drawers open with pulls as standard
- Drawer bottoms are routed into the drawer sides
- Drawer fronts are edged on all four sides with matching 3mm edge
- All drawers locking as standard
- Key alike available
- Pedestals available in 15-1/2" width and 18, 20, 23, 24, 29, 30, 36 depth, include one pencil tray
- All mobile pedestals have option for a counterweight
- Storage modules feature levellers 5/16" x 1" easily accessible from outside the unit. All others feature 5/16" x 2" levellers.
- Monopost legs available in 3 different options, 2.5" or 3" square, 3" round and 6" round
- 6 handle options
- Storage modules available in 4 heights 29", 50", 65.8", 72.8"
- Lateral modules available in 3 widths 30", 36", 42"
- Rectangular grommets are standard and can be specified in a variety of locations as standard (see Grommet Location page A.10)
- Several Power Grommets style and configurations available.
- Drawers/Door fronts are available in a different finish than that of the chassis. Please specify option. Note that the kick plate will match the drawer front finish unless otherwise noted.

**FREESTANDING - TECHNICAL INFORMATION**

**Worksurfaces**

Worksurfaces are offered in LP (1"), B (1 1/16") or W (1 7/16"). All worksurfaces are drilled to accept connectors in a desk configuration. Worksurfaces are available in the following shapes: rectangular, bow, wedge and swerve.

**Worksurface Edge trim**

Available in 1 1/16" ("B" thickness), 1 7/16" ("W" thickness) or 1" ("LP" thickness). Wood grain PVC edge trim, available in Boulevard (S) edge "B" and "W" thickness only.

**Edge Options**

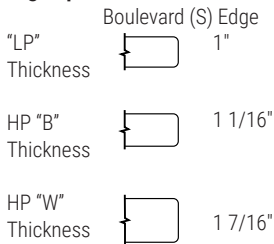

**Hardware**

All attachment hardware is included.

**Modesty Panels**

Available in full panel 27 5/8" high or half panel ("H" option) 10" high. Modesty panels are flush mounted with 24", 30" and 36" deep end gables. Modesty panels are available recessed for 30" and 36" deep end gables. All recessed modesty panels are inset 6" from the edge. Only flush modesty panels are used for extended shell and bridge. Only full modesty panels are used for "L2D" desks: Rectangular, Bow, and Wedge worksurfaces. All exposed edges are edge banded.

**Panel and Gables**

The term "end gable" or "narrow gable" is used to configure a shell, single pedestal or return. The term "end panel" or "narrow panel" is used to configure a table desk with shaped worksurfaces such as "D", "P", or profiles.

All end gables are interchangeable for left or right hand use. End gables 24", 30" and 36" deep are drilled to accept full or half modesty panels that are flush mounted. End gables 30" and 36" are used for full or half modesty panels that are recessed. All panels and end gables are 1" thick and 27 5/8" high. All panels and end gables are finished in low pressure laminate. End gables are used in shells and single pedestal desks. Narrow end gables are used in shells, single pedestal desks, "T", or "L" bases. Narrow panels are routed to accept modular connectors for "T" or "L" applications. All panels and gables are predrilled to accept levelers at the bottom and connectors at the top. All panels or gables are 3mm edge banded at the exposed edge. All narrow gables are routed at the top to allow cables to pass through and come with a connecting flat bracket. All bottom edges are edge banded.

**Handles**

- Handles are offered in 4 styles. Options are as follows: BB = Bow Matte Black, BC = Bow Matte Chrome, UB = "U"Dull Black, UC = "U"Dull Chrome, FA = Flat Aluminum, RN = Round Nickel

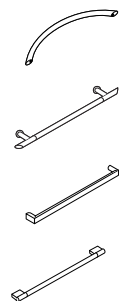

Span dimension between drilling locations is 192mm. e-lock

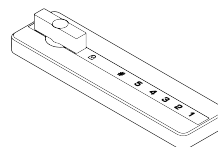

WOOD GRAIN (WG) LAMINATE DIRECTION

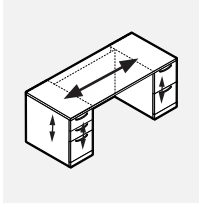

Double Pedestal Desks

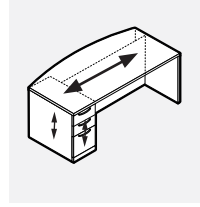

Single Pedestal Desks

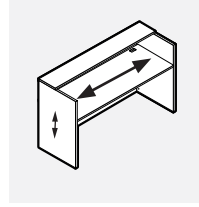

Reception Desks

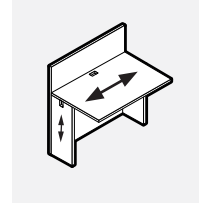

Surround Bridge

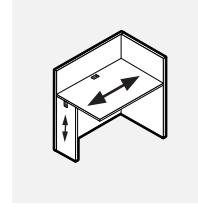

Right Hand Surround Bridge

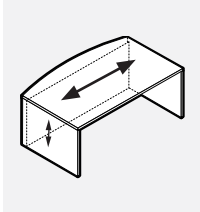

Shells

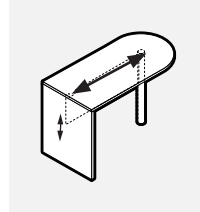

D-Shaped Tables

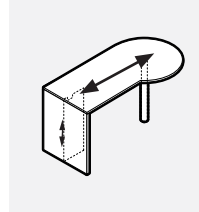

P-Shaped Tables

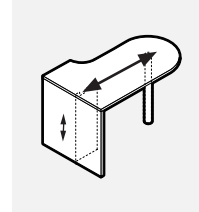

Profile Corner Round Tables

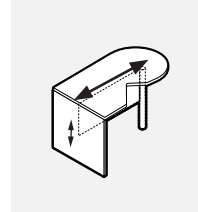

Profile Corner Cut Tables

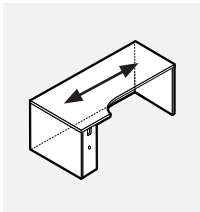

Profile Corner Desks

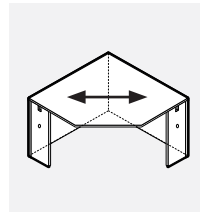

All Corner Desks 42" and Smaller

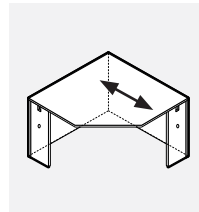

All Corner Desks Larger than 42"

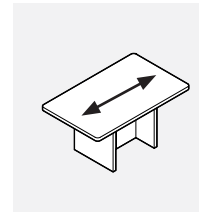

Occasional Tables

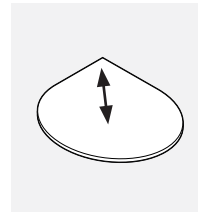

Teardrop Table Tops

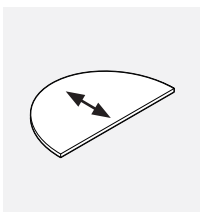

Half Moon Table Tops

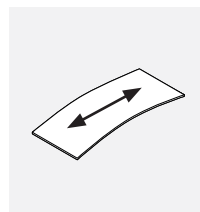

All Other Table Tops

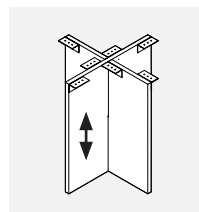

Bases

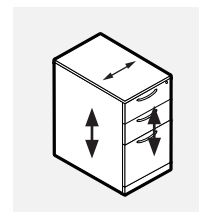

All Pedestals

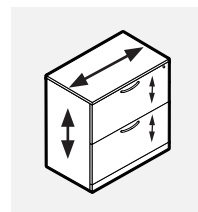

All Laterals

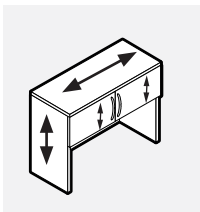

All Hinged Door Hutches

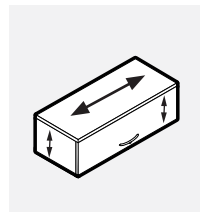

All Flip-Up Door Overheads

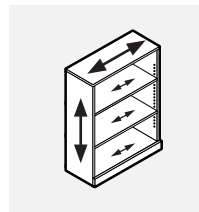

All Bookcases

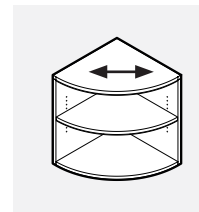

All Corner Bookcases

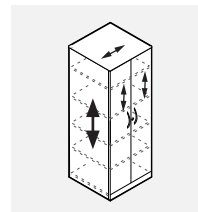

All Towers

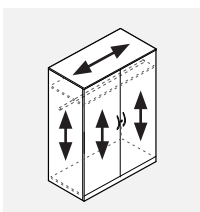

All Cabinets

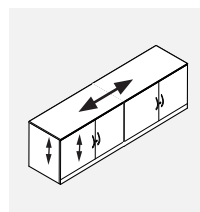

All Credenzas

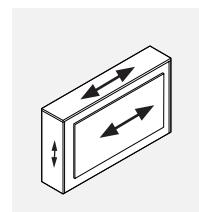

Gallery Desk

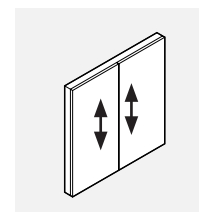

Visual Board

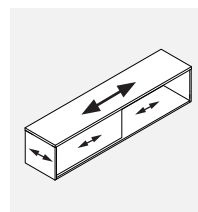

Overhead Divider Storage

## GROMMET LOCATION

### Notes

All workspaces are standard with rectangular grommets # BG5.  
 Worksurfaces 54" wide and under are standard with 1 grommet.  
 Worksurfaces over 54" wide are standard with 2 grommets.

Grommet location must be specified at time of order or it will default to "no grommet" option.

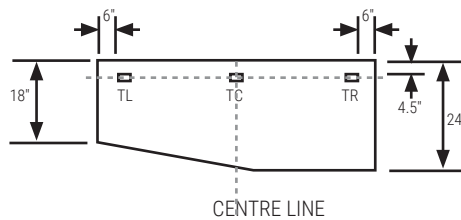
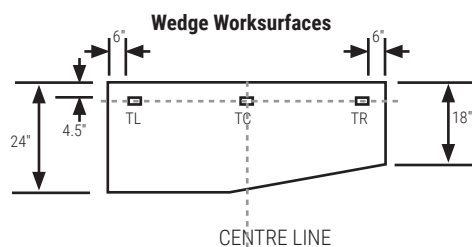
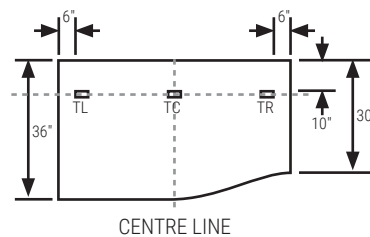
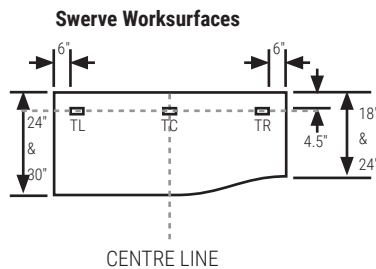
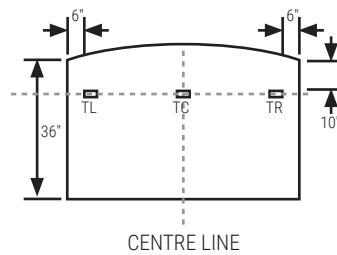
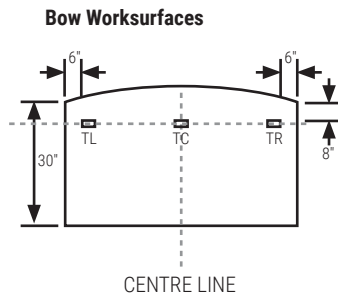
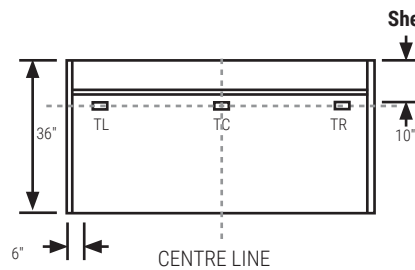
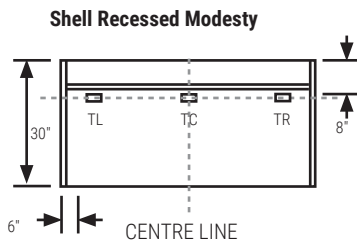
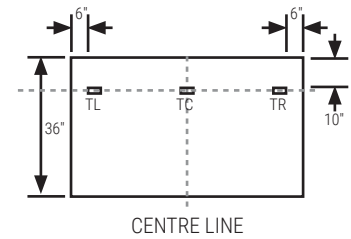
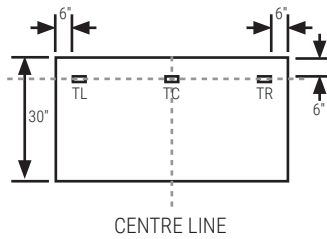
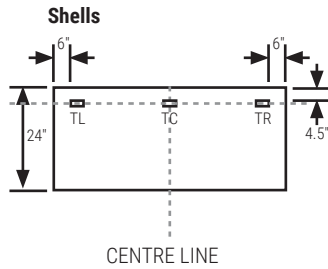
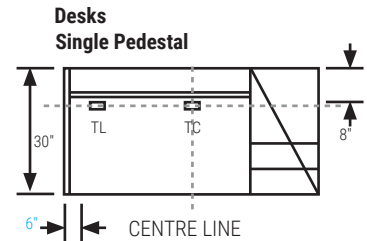
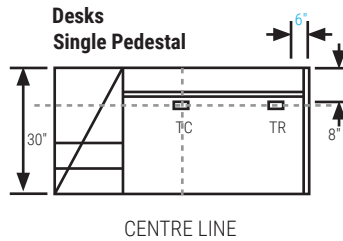
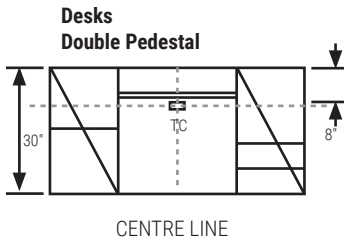

**GROMMET LOCATION**

**P-Shaped Tables "L2T"**

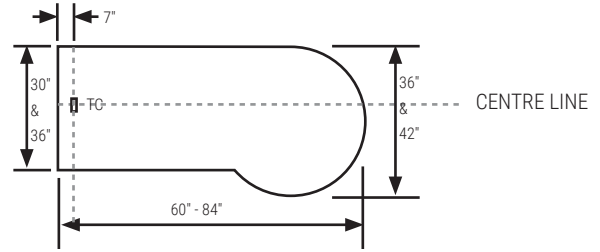
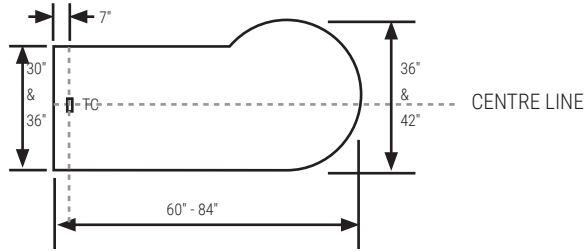

**Extended "D" - L2TED**

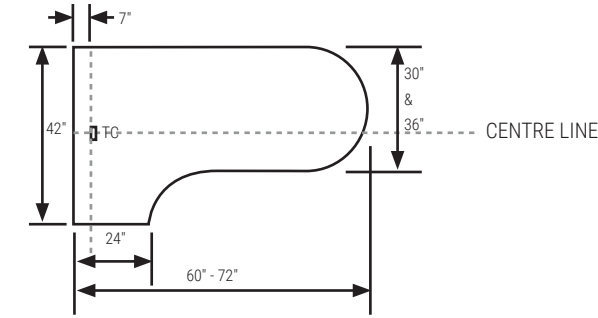

**D-Shaped Tables**

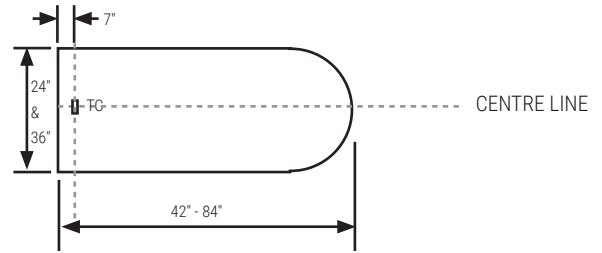

**Extended Corner "L2EC"**

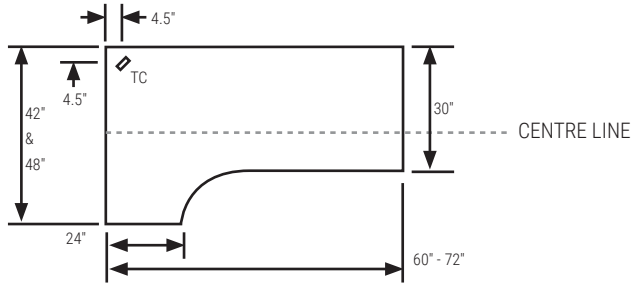

**Extended "D" Cut Out "L2TEDCO"**

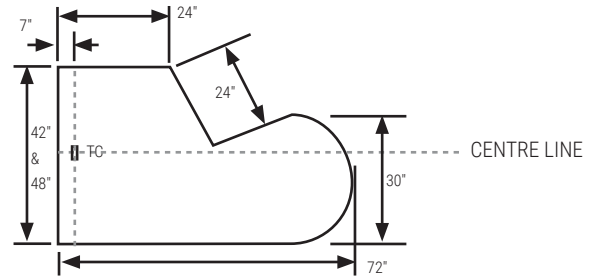

**Extended Corner Recessed Modesty**

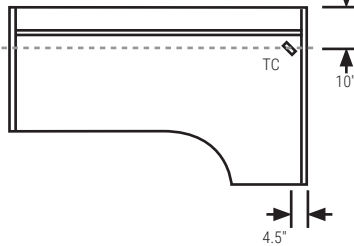

**Wedge Shell Recessed Modesty**

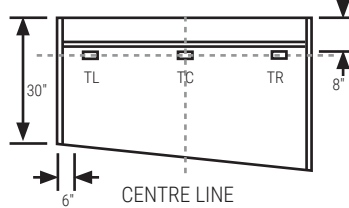

**Corner Worksurfaces - 1 Piece**

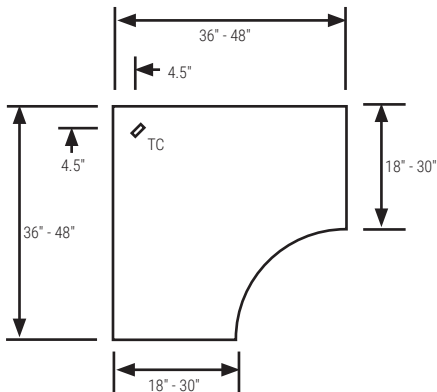

**Split Corner Worksurfaces - 2-Piece**

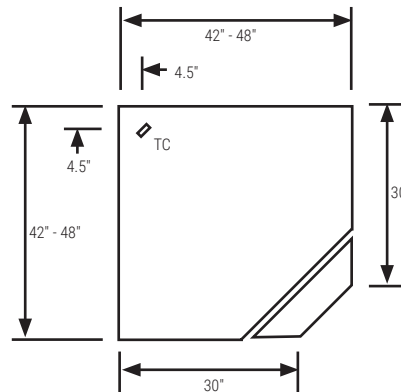

## GROMMET LOCATION

### Hockey-Shaped Tables "L2TH"



### Floating Tops "L2F"

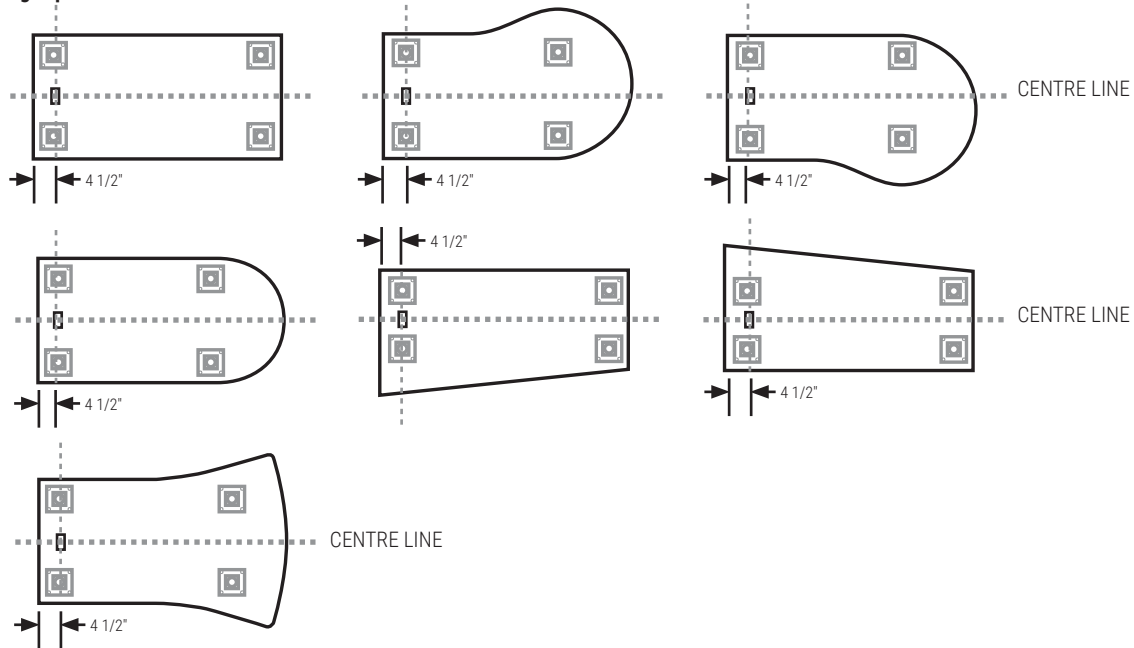

### Runoff Tops "L2TC"

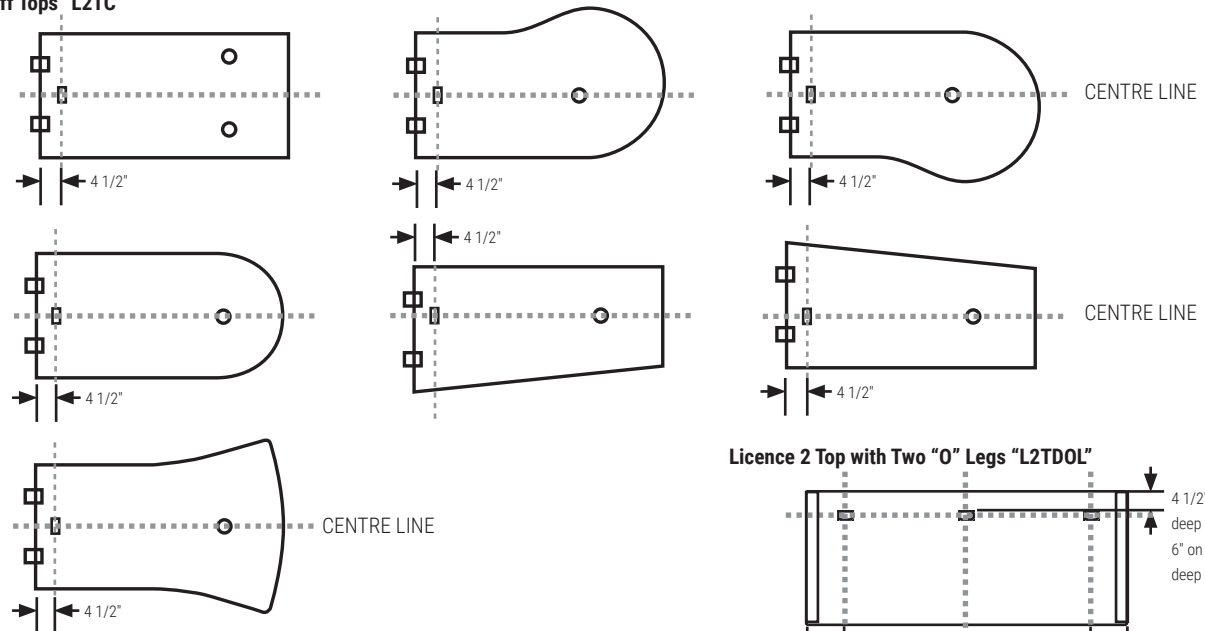

### Floating Tops "L2FFL"

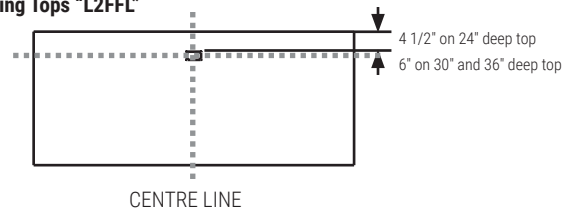

### Licence 2 Top with Two "O" Legs "L2TDOL"

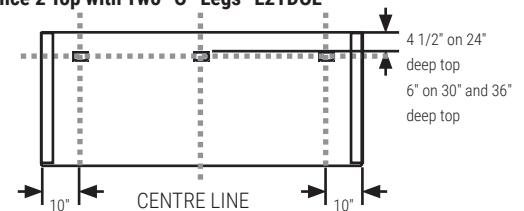

**TECHNICAL INFORMATION**

**Double Pedestal Desk/ Single Pedestal Desk**

- All desks are Shipped knocked down (KD).
- Pedestals are shipped assembled
- Pedestals are LP all over
- Non Interlocking mechanism Pedestals
- Half modesty available on all Double Pedestal Desks, specify 'H' Before size eg. L2DRH3060FB
- Half modesty available on Single Pedestal Desks, specify "H" before size eg. L2DRH3060BR
- All desks have modesty recessed 6"

**Executive Return Desk**

- All desks are Shipped knocked down (KD).
- This typed of desk must be connected at open end to adjoining worksurface with flat brackets.
- Half modesty available on all Single Pedestal Returns, specify "H" before size eg. L2RH2036FL

**Single Pedestal Returns**

- All desks are Shipped knocked down (KD).
- This type of desk must be connected at open end to adjoining worksurface with flat brackets.

**DESKS • GUIDELINES FOR ORDERING PRODUCT**

**CODES:** The price list uses a numbering system with meaningful alphanumeric characters to create a simple-to-understand product number. This makes specifying the product much easier and more accurate.

**SPECIFICATION EXAMPLE OF A DESK UNIT**

**PRODUCT CODE:**

L2DR3060FB  
 L2 = New Licence  
 D = Desk  
 R = Rectangular  
 3060 = Size: Depth x Width  
 FB = PED FF LEFT / PED BBF RIGHT

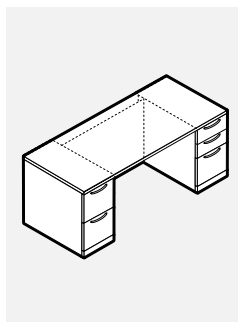

**OPTIONS:**

Top: LP - LP (Low Pressure Laminate) Thickness 1"  
 HP B - B Thickness 1 1/16"  
 HP W - W Thickness 1 7/16"

Top Finish Laminate: Choose Color

Top PVC Edging: Choose Color

Chassis Laminate: Choose Color

Chassis PVC Edging: Choose Color

**Handle Style:**

- BC - Bow Matte Chrome (DEFAULT)**  
 BB - Bow Matt Black  
 UB - "U" Dull Black  
 UC - "U" Dull Chrome  
 FA - Flat Aluminum  
 RN - Round Nickel

**Grommet Location:**

- N - No grommet (DEFAULT)**  
 Double Pedestal desk: TC - Top Center Only  
  
 Single Right Pedestal Desk: TC - Top Center  
 TL - Top Left  
  
 Single Left Pedestal Desk: TC - Top Center  
 TR - Top Right

**L2 • Keys**

PRODUCT CODE	PRICE	SIZE/ INCHES		WEIGHT LBS	VOL FT <sup>3</sup>
		H	W D		
<b>Master key:</b> L2MK	29				
<b>Extra key for existing cabinet:</b> L2EK	11				
<b>Core key:</b> L2CK	12				
<b>Core &amp; Key:</b> L2LOCKKEY	33				

- Additional key (specify at time of order).
- Please choose black or silver.

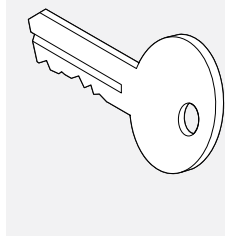

**L2DR-FB • Double Pedestal Desk, File/File Left, Box/Box/File Right, Recessed Modesty**

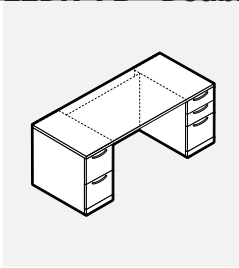

• Optional e-lock available for each pedestal in the vertical position. Please specify V - Vertical and add \$304 list for each.

PRODUCT CODE	FINISH LP	B	W	SIZE/INCHES				WEIGHT LBS	VOL FT <sup>3</sup>
				H (LP/B)	H (W)	W	D		
L2DR3060FB	2942	3115	3274	29	29.5	60	30	224	24
L2DR3066FB	2995	3186	3361	29	29.5	66	30	234	25
L2DR3072FB	3049	3258	3448	29	29.5	72	30	244	25
L2DR3078FB	3105	3330	3534	29	29.5	78	30	272	26
L2DR3084FB	3164	3406	3626	29	29.5	84	30	299	26
L2DR3672FB	3207	3458	3672	29	29.5	72	36	272	26
L2DR3678FB	3265	3539	3771	29	29.5	78	36	299	28
L2DR3684FB	3330	3611	3871	29	29.5	84	36	327	28

**L2DR-BF • Double Pedestal Desk, Box/Box/File Left, File/File Right, Recessed Modesty**

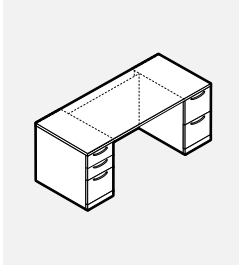

• Optional e-lock available for each pedestal in the vertical position. Please specify V - Vertical and add \$304 list for each.

PRODUCT CODE	FINISH LP	B	W	SIZE/INCHES				WEIGHT LBS	VOL FT <sup>3</sup>
				H (LP/B)	H (W)	W	D		
L2DR3060BF	2942	3115	3274	29	29.5	60	30	224	24
L2DR3066BF	2995	3186	3361	29	29.5	66	30	234	25
L2DR3072BF	3049	3258	3448	29	29.5	72	30	244	25
L2DR3078BF	3105	3330	3534	29	29.5	78	30	272	26
L2DR3084BF	3164	3406	3626	29	29.5	84	30	299	26
L2DR3672BF	3207	3458	3672	29	29.5	72	36	272	26
L2DR3678BF	3265	3539	3771	29	29.5	78	36	299	28
L2DR3684BF	3330	3611	3871	29	29.5	84	36	327	28

**L2DRH-FB • Double Pedestal Desk, File/File Left, Box/Box/File Right Recessed Half Modesty**

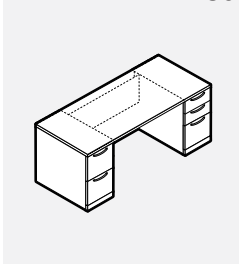

• Optional e-lock available for each pedestal in the vertical position. Please specify V - Vertical and add \$304 list for each.

PRODUCT CODE	FINISH LP	B	W	SIZE/INCHES				WEIGHT LBS	VOL FT <sup>3</sup>
				H (LP/B)	H (W)	W	D		
L2DRH3060FB	2871	3044	3206	29	29.5	60	30	224	24
L2DRH3066FB	2914	3104	3278	29	29.5	66	30	234	25
L2DRH3072FB	2954	3162	3352	29	29.5	72	30	244	25
L2DRH3078FB	2996	3220	3426	29	29.5	78	30	272	26
L2DRH3084FB	3042	3286	3503	29	29.5	84	30	299	26
L2DRH3672FB	3112	3361	3577	29	29.5	72	36	272	26
L2DRH3678FB	3158	3427	3660	29	29.5	78	36	299	28
L2DRH3684FB	3210	3502	3749	29	29.5	84	36	327	28

**L2DRH-BF • Double Pedestal Desk, Box/Box/File Left, File/File Right Recessed Half Modesty**

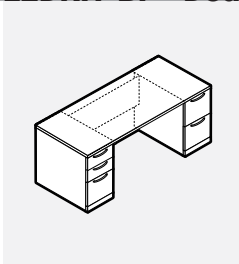

• Optional e-lock available for each pedestal in the vertical position. Please specify V - Vertical and add \$304 list for each.

PRODUCT CODE	FINISH LP	B	W	SIZE/INCHES				WEIGHT LBS	VOL FT <sup>3</sup>
				H (LP/B)	H (W)	W	D		
L2DRH3060BF	2871	3044	3206	29	29.5	60	30	224	24
L2DRH3066BF	2914	3104	3278	29	29.5	66	30	234	25
L2DRH3072BF	2954	3162	3352	29	29.5	72	30	244	25
L2DRH3078BF	2996	3220	3426	29	29.5	78	30	272	26
L2DRH3084BF	3042	3286	3503	29	29.5	84	30	299	26
L2DRH3672BF	3112	3361	3577	29	29.5	72	36	272	26
L2DRH3678BF	3158	3427	3660	29	29.5	78	36	299	28
L2DRH3684BF	3210	3502	3749	29	29.5	84	36	327	28

**L2DB-FB • Bowfront Double Pedestal Desk, File/File Left, Box/Box/File Right, Recessed Modesty**

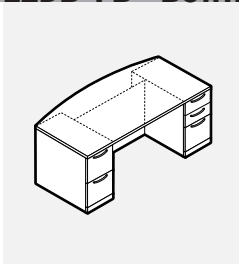

• Optional e-lock available for each pedestal in the vertical position. Please specify V - Vertical and add \$304 list for each.

PRODUCT CODE	FINISH LP	B	W	SIZE/INCHES				WEIGHT LBS	VOL FT <sup>3</sup>
				H (LP/B)	H (W)	W	D		
L2DB3060FB	3007	3215	3399	29	29.5	60	36	374	25
L2DB3066FB	3071	3298	3493	29	29.5	66	36	383	26
L2DB3072FB	3129	3378	3589	29	29.5	72	36	395	26
L2DB3078FB	3191	3460	3683	29	29.5	78	36	422	28
L2DB3084FB	3253	3544	3784	29	29.5	84	36	450	28
L2DB3672FB	3287	3577	3812	29	29.5	72	42	422	28
L2DB3678FB	3352	3666	3918	29	29.5	78	42	450	29
L2DB3684FB	3420	3758	4028	29	29.5	84	42	477	29

**L2DB-BF • Bowfront Double Pedestal Desk, File/File Right, Box/Box/File Left, Recessed Modesty**

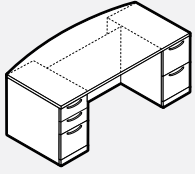

• Optional e-lock available for each pedestal in the vertical position. Please specify V - Vertical and add \$304 list for each.

PRODUCT CODE	FINISH LP	B	W	SIZE / INCHES				WEIGHT LBS	VOL FT <sup>3</sup>
				H(LP/B)	H(W)	W	D		
L2DB3060BF	3007	3215	3399	29	29.5	60	36	374	25
L2DB3066BF	3071	3298	3493	29	29.5	66	36	383	26
L2DB3072BF	3129	3378	3589	29	29.5	72	36	395	26
L2DB3078BF	3191	3460	3683	29	29.5	78	36	422	28
L2DB3084BF	3253	3544	3784	29	29.5	84	36	450	28
L2DB3672BF	3287	3577	3812	29	29.5	72	42	422	28
L2DB3678BF	3352	3666	3918	29	29.5	78	42	450	29
L2DB3684BF	3420	3758	4028	29	29.5	84	42	477	29

**L2DBH-FB • Bowfront Double Pedestal Desk, File/File Left, Box/Box/File Right Recessed Half Modesty**

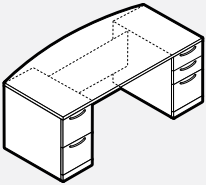

• Optional e-lock available for each pedestal in the vertical position. Please specify V - Vertical and add \$304 list for each.

PRODUCT CODE	FINISH LP	B	W	SIZE / INCHES				WEIGHT LBS	VOL FT <sup>3</sup>
				H(LP/B)	H(W)	W	D		
L2DBH3060FB	2942	3150	3328	29	29.5	60	36	374	25
L2DBH3066FB	2988	3215	3411	29	29.5	66	36	383	26
L2DBH3072FB	3034	3282	3493	29	29.5	72	36	395	26
L2DBH3078FB	3080	3352	3575	29	29.5	78	36	422	28
L2DBH3084FB	3131	3422	3663	29	29.5	84	36	450	28
L2DBH3672FB	3191	3481	3717	29	29.5	72	42	422	28
L2DBH3678FB	3242	3558	3807	29	29.5	78	42	450	29
L2DBH3684FB	3299	3637	3907	29	29.5	84	42	477	29

**L2DBH-BF • Bowfront Double Pedestal Desk, Box/Box/File Left, File/File Right Recessed Half Modesty**

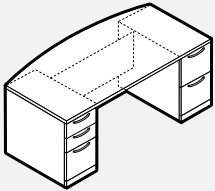

• Optional e-lock available for the pedestal in the vertical position. Please specify V - Vertical and add \$304 list for each.

PRODUCT CODE	FINISH LP	B	W	SIZE / INCHES				WEIGHT LBS	VOL FT <sup>3</sup>
				H(LP/B)	H(W)	W	D		
L2DBH3060BF	2942	3150	3328	29	29.5	60	36	374	25
L2DBH3066BF	2988	3215	3411	29	29.5	66	36	383	26
L2DBH3072BF	3034	3282	3493	29	29.5	72	36	395	26
L2DBH3078BF	3080	3352	3575	29	29.5	78	36	422	28
L2DBH3084BF	3131	3422	3663	29	29.5	84	36	450	28
L2DBH3672BF	3191	3481	3717	29	29.5	72	42	422	28
L2DBH3678BF	3242	3558	3807	29	29.5	78	42	450	29
L2DBH3684BF	3299	3637	3907	29	29.5	84	42	477	29

**L2DR-BR • Single Pedestal Desk, Box/Box/File Right, Recessed Modesty**

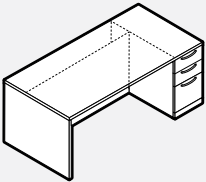

• Optional e-lock available for the pedestal in the vertical position. Please specify V - Vertical and add \$304 list.

PRODUCT CODE	FINISH LP	B	W	SIZE / INCHES				WEIGHT LBS	VOL FT <sup>3</sup>
				H(LP/B)	H(W)	W	D		
L2DR3060BR	2041	2213	2374	29	29.5	60	30	224	14
L2DR3066BR	2095	2287	2461	29	29.5	66	30	234	15
L2DR3072BR	2150	2358	2548	29	29.5	72	30	244	15
L2DR3078BR	2197	2422	2625	29	29.5	78	30	272	17
L2DR3084BR	2265	2509	2726	29	29.5	84	30	299	17
L2DR3672BR	2288	2536	2754	29	29.5	72	36	272	17
L2DR3678BR	2341	2610	2841	29	29.5	78	36	299	18
L2DR3684BR	2412	2702	2951	29	29.5	84	36	327	18

**L2DR-BL • Single Pedestal Desk, Box/Box/File Left, Recessed Modesty**

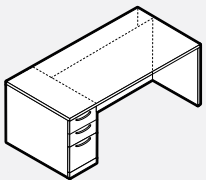

• Optional e-lock available for the pedestal in the vertical position. Please specify V - Vertical and add \$304 list.

PRODUCT CODE	FINISH LP	B	W	SIZE / INCHES				WEIGHT LBS	VOL FT <sup>3</sup>
				H(LP/B)	H(W)	W	D		
L2DR3060BL	2041	2213	2374	29	29.5	60	30	224	14
L2DR3066BL	2095	2287	2461	29	29.5	66	30	234	15
L2DR3072BL	2150	2358	2548	29	29.5	72	30	244	15
L2DR3078BL	2197	2422	2625	29	29.5	78	30	272	17
L2DR3084BL	2265	2509	2726	29	29.5	84	30	299	17
L2DR3672BL	2288	2536	2754	29	29.5	72	36	272	17
L2DR3678BL	2341	2610	2841	29	29.5	78	36	299	18
L2DR3684BL	2412	2702	2951	29	29.5	84	36	327	18



**L2DRH-BR • Single Pedestal Desk, Box/Box/File Right Recessed Half Modesty**

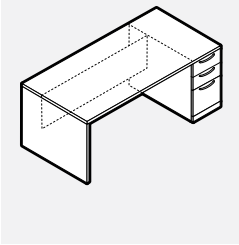

• Optional e-lock available for the pedestal in the vertical position. Please specify V - Vertical and add \$304 list.

PRODUCT CODE	FINISH LP	B	W	SIZE/INCHES				D	WEIGHT LBS	VOL FT <sup>3</sup>
				H(LP/B)	H(W)	W	D			
L2DRH3060BR	1909	2080	2243	29	29.5	60	30	224	14	
L2DRH3066BR	1950	2141	2315	29	29.5	66	30	234	15	
L2DRH3072BR	1991	2200	2391	29	29.5	72	30	244	15	
L2DRH3078BR	2034	2258	2461	29	29.5	78	30	272	17	
L2DRH3084BR	2079	2320	2538	29	29.5	84	30	299	17	
L2DRH3672BR	2130	2379	2596	29	29.5	72	36	272	17	
L2DRH3678BR	2176	2445	2678	29	29.5	78	36	299	18	
L2DRH3684BR	2225	2519	2768	29	29.5	84	36	327	18	

**L2DRH-BL • Single Pedestal Desk, Box/Box/File Left Recessed Half Modesty**

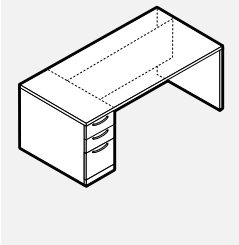

• Optional e-lock available for the pedestal in the vertical position. Please specify V - Vertical and add \$304 list.

PRODUCT CODE	FINISH LP	B	W	SIZE/INCHES				D	WEIGHT LBS	VOL FT <sup>3</sup>
				H(LP/B)	H(W)	W	D			
L2DRH3060BL	1909	2080	2243	29	29.5	60	30	224	14	
L2DRH3066BL	1950	2141	2315	29	29.5	66	30	234	15	
L2DRH3072BL	1991	2200	2391	29	29.5	72	30	244	15	
L2DRH3078BL	2034	2258	2461	29	29.5	78	30	272	17	
L2DRH3084BL	2079	2320	2538	29	29.5	84	30	299	17	
L2DRH3672BL	2130	2379	2596	29	29.5	72	36	272	17	
L2DRH3678BL	2176	2445	2678	29	29.5	78	36	299	18	
L2DRH3684BL	2225	2519	2768	29	29.5	84	36	327	18	

**L2DB-BR • Bowfront Single Pedestal Desk, Box/Box/File Right, Recessed Modesty**

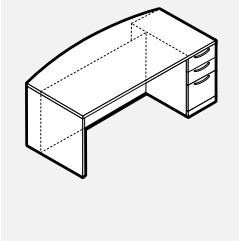

• Optional e-lock available for the pedestal in the vertical position. Please specify V - Vertical and add \$304 list.

PRODUCT CODE	FINISH LP	B	W	SIZE/INCHES				D	WEIGHT LBS	VOL FT <sup>3</sup>
				H(LP/B)	H(W)	W	D			
L2DB3060BR	2110	2316	2499	29	29.5	60	36	264	14	
L2DB3066BR	2171	2398	2596	29	29.5	66	36	274	15	
L2DB3072BR	2229	2478	2689	29	29.5	72	36	286	15	
L2DB3078BR	2283	2553	2776	29	29.5	78	36	314	17	
L2DB3084BR	2354	2645	2883	29	29.5	84	36	338	17	
L2DB3672BR	2366	2656	2893	29	29.5	72	42	310	17	
L2DB3678BR	2424	2738	2991	29	29.5	78	42	338	18	
L2DB3684BR	2501	2840	3109	29	29.5	84	42	362	18	

**L2DB-BL • Bowfront Single Pedestal Desk, Box/Box/File Left, Recessed Modesty**

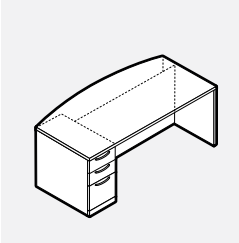

• Optional e-lock available for the pedestal in the vertical position. Please specify V - Vertical and add \$304 list.

PRODUCT CODE	FINISH LP	B	W	SIZE/INCHES				D	WEIGHT LBS	VOL FT <sup>3</sup>
				H(LP/B)	H(W)	W	D			
L2DB3060BL	2110	2316	2499	29	29.5	60	36	264	14	
L2DB3066BL	2171	2398	2596	29	29.5	66	36	274	15	
L2DB3072BL	2229	2478	2689	29	29.5	72	36	286	15	
L2DB3078BL	2283	2553	2776	29	29.5	78	36	314	17	
L2DB3084BL	2354	2645	2883	29	29.5	84	36	338	17	
L2DB3672BL	2366	2656	2893	29	29.5	72	42	310	17	
L2DB3678BL	2424	2738	2991	29	29.5	78	42	338	18	
L2DB3684BL	2501	2840	3109	29	29.5	84	42	362	18	

**L2DBH-BR • Bowfront Single Pedestal Desk, Box/Box/File Right Recessed Half Modesty**

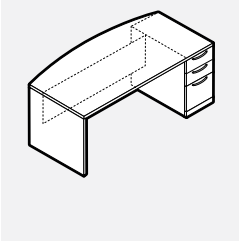

• Optional e-lock available for the pedestal in the vertical position. Please specify V - Vertical and add \$304 list.

PRODUCT CODE	FINISH LP	B	W	SIZE/INCHES				D	WEIGHT LBS	VOL FT <sup>3</sup>
				H(LP/B)	H(W)	W	D			
L2DBH3060BR	1977	2184	2364	29	29.5	60	36	264	14	
L2DBH3066BR	2023	2252	2447	29	29.5	66	36	274	15	
L2DBH3072BR	2071	2319	2530	29	29.5	72	36	286	15	
L2DBH3078BR	2117	2387	2611	29	29.5	78	36	314	17	
L2DBH3084BR	2168	2460	2698	29	29.5	84	36	338	17	
L2DBH3672BR	2204	2499	2733	29	29.5	72	42	310	17	
L2DBH3678BR	2258	2573	2827	29	29.5	78	42	338	18	
L2DBH3684BR	2315	2655	2924	29	29.5	84	42	362	18	

**L2DBH-BL • Bowfront Single Pedestal Desk, Box/Box/File Left Recessed Half Modesty**

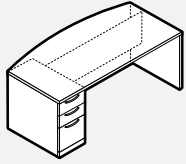

- Optional e-lock available for the pedestal in the vertical position. Please specify V - Vertical and add \$304 list.

PRODUCT CODE	FINISH LP	B	W	SIZE / INCHES				WEIGHT LBS	VOL FT <sup>3</sup>
				H(LP/B)	H(W)	W	D		
L2DBH3060BL	1977	2184	2364	29	29.5	60	36	264	14
L2DBH3066BL	2023	2252	2447	29	29.5	66	36	274	15
L2DBH3072BL	2071	2319	2530	29	29.5	72	36	286	15
L2DBH3078BL	2117	2387	2611	29	29.5	78	36	314	17
L2DBH3084BL	2168	2460	2698	29	29.5	84	36	338	17
L2DBH3672BL	2204	2499	2733	29	29.5	72	42	310	17
L2DBH3678BL	2258	2573	2827	29	29.5	78	42	338	18
L2DBH3684BL	2315	2655	2924	29	29.5	84	42	362	18

**L2DRA-FB • Double Desk, File/File Left Box/Box/File Right Recessed, Glazed Full Modesty**

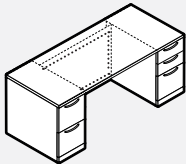

- Modesty is aluminum framed.
- Glazing is frosted acrylic.
- Optional e-lock available for each pedestal in the vertical position. Please specify V - Vertical and add \$304 list for each.

PRODUCT CODE	FINISH LP	B	W	SIZE / INCHES				WEIGHT LBS	VOL FT <sup>3</sup>
				H(LP/B)	H(W)	W	D		
L2DRA3060FB	3712	3892	4060	29.06	29.5	60	30	204	22
L2DRA3066FB	3827	4023	4208	29.06	29.5	66	30	213	23
L2DRA3072FB	3944	4157	4355	29.06	29.5	72	30	222	23
L2DRA3078FB	4054	4291	4501	29.06	29.5	78	30	247	24
L2DRA3084FB	4174	4427	4654	29.06	29.5	84	30	272	24
L2DRA3672FB	4105	4366	4589	29.06	29.5	72	36	247	24
L2DRA3678FB	4222	4505	4748	29.06	29.5	78	36	272	25
L2DRA3684FB	4348	4652	4912	29.06	29.5	84	36	297	25

**L2DRA-BF • Double Desk, File/File Right Box/Box/File Left Recessed, Glazed Full Modesty**

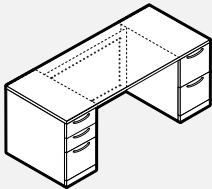

- Modesty is aluminum framed.
- Glazing is frosted acrylic.
- Optional e-lock available for each pedestal in the vertical position. Please specify V - Vertical and add \$304 list for each.

PRODUCT CODE	FINISH LP	B	W	SIZE / INCHES				WEIGHT LBS	VOL FT <sup>3</sup>
				H(LP/B)	H(W)	W	D		
L2DRA3060BF	3712	3892	4060	29.06	29.5	60	30	204	22
L2DRA3066BF	3827	4023	4208	29.06	29.5	66	30	213	23
L2DRA3072BF	3944	4157	4355	29.06	29.5	72	30	222	23
L2DRA3078BF	4054	4291	4501	29.06	29.5	78	30	247	24
L2DRA3084BF	4174	4427	4654	29.06	29.5	84	30	272	24
L2DRA3672BF	4105	4366	4589	29.06	29.5	72	36	247	24
L2DRA3678BF	4222	4505	4748	29.06	29.5	78	36	272	25
L2DRA3684BF	4348	4652	4912	29.06	29.5	84	36	297	25

**L2DBA-FB • Bowfront Double Desk, File/File Left Box/Box/File Right Recessed, Glazed Full Modesty**

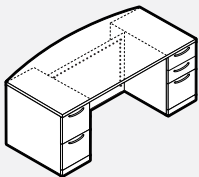

- Modesty is aluminum framed.
- Glazing is frosted acrylic.
- Optional e-lock available for each pedestal in the vertical position. Please specify V - Vertical and add \$304 list for each.

PRODUCT CODE	FINISH LP	B	W	SIZE / INCHES				WEIGHT LBS	VOL FT <sup>3</sup>
				H(LP/B)	H(W)	W	D		
L2DBA3060FB	3783	3999	4186	29.06	29.5	60	36	340	23
L2DBA3066FB	3903	4143	4343	29.06	29.5	66	36	348	24
L2DBA3072FB	4023	4284	4501	29.06	29.5	72	36	359	24
L2DBA3078FB	4144	4424	4659	29.06	29.5	78	36	384	25
L2DBA3084FB	4268	4571	4820	29.06	29.5	84	36	409	25
L2DBA3672FB	4186	4489	4733	29.06	29.5	72	42	384	25
L2DBA3678FB	4312	4640	4901	29.06	29.5	78	42	409	26
L2DBA3684FB	4442	4796	5075	29.06	29.5	84	42	434	26

**L2DBA-BF • Bowfront Double Desk, File/File Right Box/Box/File Left Recessed, Glazed Full Modesty**

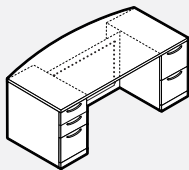

- Modesty is aluminum framed.
- Glazing is frosted acrylic.
- Optional e-lock available for each pedestal in the vertical position. Please specify V - Vertical and add \$304 list for each.

PRODUCT CODE	FINISH LP	B	W	SIZE / INCHES				WEIGHT LBS	VOL FT <sup>3</sup>
				H(LP/B)	H(W)	W	D		
L2DBA3060BF	3783	3999	4186	29.06	29.5	60	36	340	23
L2DBA3066BF	3903	4143	4343	29.06	29.5	66	36	348	24
L2DBA3072BF	4023	4284	4501	29.06	29.5	72	36	359	24
L2DBA3078BF	4144	4424	4659	29.06	29.5	78	36	384	25
L2DBA3084BF	4268	4571	4820	29.06	29.5	84	36	409	25
L2DBA3672BF	4186	4489	4733	29.06	29.5	72	42	384	25
L2DBA3678BF	4312	4640	4901	29.06	29.5	78	42	409	26
L2DBA3684BF	4442	4796	5075	29.06	29.5	84	42	434	26

**L2DRAH-FB • Double Pedestal Desk, File/File Left Box/Box/File Right Recessed, Half Glazed Modesty**

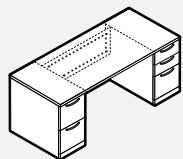

- Modesty is aluminum framed.
- Glazing is frosted acrylic.
- Optional e-lock available for each pedestal in the vertical position. Please specify V - Vertical and add \$304 list for each.

PRODUCT CODE	FINISH LP	B	W	SIZE/INCHES			D	WEIGHT LBS	VOL FT <sup>3</sup>
				H(LP/B)	H(W)	W			
L2DRAH3060FB	3514	3695	3863	29.06	29.5	60	30	204	22
L2DRAH3066FB	3609	3806	3989	29.06	29.5	66	30	213	23
L2DRAH3072FB	3691	3907	4105	29.06	29.5	72	30	222	23
L2DRAH3078FB	3776	4006	4219	29.06	29.5	78	30	247	24
L2DRAH3084FB	3863	4116	4340	29.06	29.5	84	30	272	24
L2DRAH3672FB	3854	4113	4336	29.06	29.5	72	36	247	24
L2DRAH3678FB	3944	4222	4465	29.06	29.5	78	36	272	25
L2DRAH3684FB	4036	4336	4595	29.06	29.5	84	36	297	25

**L2DRAH-BF • Double Pedestal Desk, Box/Box/File Left File/File Right Recessed, Half Glazed Modesty**

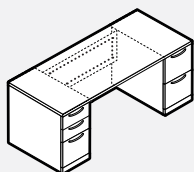

- Modesty is aluminum framed.
- Glazing is frosted acrylic.
- Optional e-lock available for each pedestal in the vertical position. Please specify V - Vertical and add \$304 list for each.

PRODUCT CODE	FINISH LP	B	W	SIZE/INCHES			D	WEIGHT LBS	VOL FT <sup>3</sup>
				H(LP/B)	H(W)	W			
L2DRAH3060BF	3514	3695	3863	29.06	29.5	60	30	204	22
L2DRAH3066BF	3609	3806	3989	29.06	29.5	66	30	213	23
L2DRAH3072BF	3691	3907	4105	29.06	29.5	72	30	222	23
L2DRAH3078BF	3776	4006	4219	29.06	29.5	78	30	247	24
L2DRAH3084BF	3863	4116	4340	29.06	29.5	84	30	272	24
L2DRAH3672BF	3854	4113	4336	29.06	29.5	72	36	247	24
L2DRAH3678BF	3944	4222	4465	29.06	29.5	78	36	272	25
L2DRAH3684BF	4036	4336	4595	29.06	29.5	84	36	297	25

**L2DBAH-FB • Bowfront Double Desk, File/File Left Box/Box/File Right Recessed, Half Glazed Modesty**

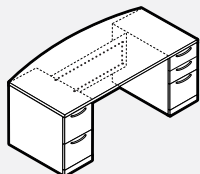

- Modesty is aluminum framed.
- Glazing is frosted acrylic.
- Optional e-lock available for each pedestal in the vertical position. Please specify V - Vertical and add \$304 list for each.

PRODUCT CODE	FINISH LP	B	W	SIZE/INCHES			D	WEIGHT LBS	VOL FT <sup>3</sup>
				H(LP/B)	H(W)	W			
L2DBAH3060FB	3584	3799	3989	29.06	29.5	60	36	340	23
L2DBAH3066FB	3683	3919	4124	29.06	29.5	66	36	348	24
L2DBAH3072FB	3773	4033	4252	29.06	29.5	72	36	359	24
L2DBAH3078FB	3860	4143	4377	29.06	29.5	78	36	384	25
L2DBAH3084FB	3955	4257	4507	29.06	29.5	84	36	409	25
L2DBAH3672FB	3936	4240	4483	29.06	29.5	72	42	384	25
L2DBAH3678FB	4032	4359	4620	29.06	29.5	78	42	409	26
L2DBAH3684FB	4127	4480	4760	29.06	29.5	84	42	434	26

**L2DBAH-BF • Bowfront Double Desk, Box/Box/File Left File/File Right Recessed, Half Glazed Modesty**

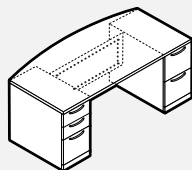

- Modesty is aluminum framed.
- Glazing is frosted acrylic.
- Optional e-lock available for each pedestal in the vertical position. Please specify V - Vertical and add \$304 list for each.

PRODUCT CODE	FINISH LP	B	W	SIZE/INCHES			D	WEIGHT LBS	VOL FT <sup>3</sup>
				H(LP/B)	H(W)	W			
L2DBAH3060BF	3584	3799	3989	29.06	29.5	60	36	340	23
L2DBAH3066BF	3683	3919	4124	29.06	29.5	66	36	348	24
L2DBAH3072BF	3773	4033	4252	29.06	29.5	72	36	359	24
L2DBAH3078BF	3860	4143	4377	29.06	29.5	78	36	384	25
L2DBAH3084BF	3955	4257	4507	29.06	29.5	84	36	409	25
L2DBAH3672BF	3936	4240	4483	29.06	29.5	72	42	384	25
L2DBAH3678BF	4032	4359	4620	29.06	29.5	78	42	409	26
L2DBAH3684BF	4127	4480	4760	29.06	29.5	84	42	434	26

**L2ER-FL • Executive Return With File/File Pedestal Left**

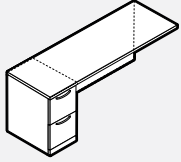

• Optional e-lock available for the pedestal in the vertical position. Please specify V - Vertical and add \$304 list.

PRODUCT CODE	FINISH			SIZE / INCHES				WEIGHT LBS	VOL FT <sup>3</sup>
	LP	B	W	H (LP/B)	H (W)	W	D		
L2ER2036FL	1458	1540	1624	29	29.5	36	20	151	12
L2ER2042FL	1509	1607	1702	29	29.5	42	20	172	12
L2ER2048FL	1563	1672	1781	29	29.5	48	20	179	12
L2ER2054FL	1614	1739	1860	29	29.5	54	20	184	13
L2ER2436FL	1515	1601	1691	29	29.5	36	24	151	12
L2ER2442FL	1569	1669	1772	29	29.5	42	24	172	12
L2ER2448FL	1624	1739	1853	29	29.5	48	24	179	13
L2ER2454FL	1679	1810	1933	29	29.5	54	24	184	13

**L2ER-FR • Executive Return With File/File Pedestal Right**

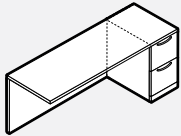

• Optional e-lock available for the pedestal in the vertical position. Please specify V - Vertical and add \$304 list.

PRODUCT CODE	FINISH			SIZE / INCHES				WEIGHT LBS	VOL FT <sup>3</sup>
	LP	B	W	H (LP/B)	H (W)	W	D		
L2ER2036FR	1458	1540	1624	29	29.5	36	20	151	12
L2ER2042FR	1509	1607	1702	29	29.5	42	20	172	12
L2ER2048FR	1563	1672	1781	29	29.5	48	20	179	12
L2ER2054FR	1614	1739	1860	29	29.5	54	20	184	13
L2ER2436FR	1515	1601	1691	29	29.5	36	24	151	12
L2ER2442FR	1569	1669	1772	29	29.5	42	24	172	12
L2ER2448FR	1624	1739	1853	29	29.5	48	24	179	13
L2ER2454FR	1679	1810	1933	29	29.5	54	24	184	13

**L2ERH-FL • Executive Return With File/File Pedestal Left and Half Modesty**

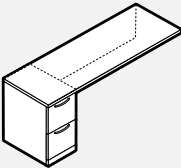

• Optional e-lock available for the pedestal in the vertical position. Please specify V - Vertical and add \$304 list.

PRODUCT CODE	FINISH			SIZE / INCHES				WEIGHT LBS	VOL FT <sup>3</sup>
	LP	B	W	H (LP/B)	H (W)	W	D		
L2ERH2036FL	1391	1475	1561	29	29.5	36	20	151	12
L2ERH2042FL	1430	1528	1624	29	29.5	42	20	172	12
L2ERH2048FL	1467	1578	1688	29	29.5	48	20	179	12
L2ERH2054FL	1505	1630	1748	29	29.5	54	20	184	13
L2ERH2436FL	1446	1533	1621	29	29.5	36	24	151	12
L2ERH2442FL	1486	1587	1679	29	29.5	42	24	172	12
L2ERH2448FL	1526	1642	1756	29	29.5	48	24	179	13
L2ERH2454FL	1565	1695	1819	29	29.5	54	24	184	13

**L2ERH-FR • Executive Return With File/File Pedestal Right and Half Modesty**

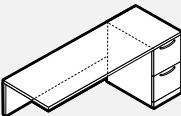

• Optional e-lock available for the pedestal in the vertical position. Please specify V - Vertical and add \$304 list.

PRODUCT CODE	FINISH			SIZE / INCHES				WEIGHT LBS	VOL FT <sup>3</sup>
	LP	B	W	H (LP/B)	H (W)	W	D		
L2ERH2036FR	1391	1475	1561	29	29.5	36	20	151	12
L2ERH2042FR	1430	1528	1624	29	29.5	42	20	172	12
L2ERH2048FR	1467	1578	1688	29	29.5	48	20	179	12
L2ERH2054FR	1505	1630	1748	29	29.5	54	20	184	13
L2ERH2436FR	1446	1533	1621	29	29.5	36	24	151	12
L2ERH2442FR	1486	1587	1679	29	29.5	42	24	172	12
L2ERH2448FR	1526	1642	1756	29	29.5	48	24	179	13
L2ERH2454FR	1565	1695	1819	29	29.5	54	24	184	13

**L2ER-BL • Executive Return With Box/Box/File Pedestal Left**

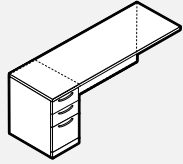

• Optional e-lock available for the pedestal in the vertical position. Please specify V - Vertical and add \$304 list.

PRODUCT CODE	FINISH LP	B	W	SIZE/INCHES				D	WEIGHT LBS	VOL FT <sup>3</sup>
				H(LP/B)	H(W)	W	D			
L2ER2036BL	1533	1615	1702	29	29.5	36	20	151	12	
L2ER2042BL	1588	1686	1781	29	29.5	42	20	172	12	
L2ER2048BL	1641	1752	1860	29	29.5	48	20	179	12	
L2ER2054BL	1694	1818	1938	29	29.5	54	20	184	13	
L2ER2436BL	1596	1684	1772	29	29.5	36	24	151	12	
L2ER2442BL	1650	1752	1853	29	29.5	42	24	172	12	
L2ER2448BL	1705	1821	1934	29	29.5	48	24	179	13	
L2ER2454BL	1763	1890	2050	29	29.5	54	24	184	13	

**L2ER-BR • Executive Return With Box/Box/File Pedestal Right**

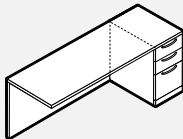

• Optional e-lock available for the pedestal in the vertical position. Please specify V - Vertical and add \$304 list.

PRODUCT CODE	FINISH LP	B	W	SIZE/INCHES				D	WEIGHT LBS	VOL FT <sup>3</sup>
				H(LP/B)	H(W)	W	D			
L2ER2036BR	1533	1615	1702	29	29.5	36	20	151	12	
L2ER2042BR	1588	1686	1781	29	29.5	42	20	172	12	
L2ER2048BR	1641	1752	1860	29	29.5	48	20	179	12	
L2ER2054BR	1694	1818	1938	29	29.5	54	20	184	13	
L2ER2436BR	1596	1684	1772	29	29.5	36	24	151	12	
L2ER2442BR	1650	1752	1853	29	29.5	42	24	172	12	
L2ER2448BR	1705	1821	1934	29	29.5	48	24	179	13	
L2ER2454BR	1763	1890	2050	29	29.5	54	24	184	13	

**L2ERH-BL • Executive Return With Box/Box/File Pedestal Left and Half Modesty**

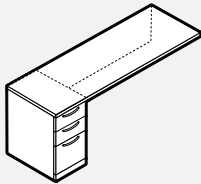

• Optional e-lock available for the pedestal in the vertical position. Please specify V - Vertical and add \$304 list.

PRODUCT CODE	FINISH LP	B	W	SIZE/INCHES				D	WEIGHT LBS	VOL FT <sup>3</sup>
				H(LP/B)	H(W)	W	D			
L2ERH2036BL	1470	1553	1641	29	29.5	36	20	151	12	
L2ERH2042BL	1507	1542	1701	29	29.5	42	20	172	12	
L2ERH2048BL	1547	1656	1766	29	29.5	48	20	179	12	
L2ERH2054BL	1583	1707	1826	29	29.5	54	20	184	13	
L2ERH2436BL	1528	1614	1702	29	29.5	36	24	151	12	
L2ERH2442BL	1566	1668	1770	29	29.5	42	24	172	12	
L2ERH2448BL	1607	1723	1836	29	29.5	48	24	179	13	
L2ERH2454BL	1646	1776	1901	29	29.5	54	24	184	13	

**L2ERH-BR • Executive Return With Box/Box/File Pedestal Right and Half Modesty**

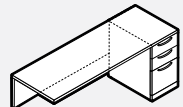

• Optional e-lock available for the pedestal in the vertical position. Please specify V - Vertical and add \$304 list.

PRODUCT CODE	FINISH LP	B	W	SIZE/INCHES				D	WEIGHT LBS	VOL FT <sup>3</sup>
				H(LP/B)	H(W)	W	D			
L2ERH2036BR	1470	1553	1641	29	29.5	36	20	151	12	
L2ERH2042BR	1507	1542	1701	29	29.5	42	20	172	12	
L2ERH2048BR	1547	1656	1766	29	29.5	48	20	179	12	
L2ERH2054BR	1583	1707	1826	29	29.5	54	20	184	13	
L2ERH2436BR	1528	1614	1702	29	29.5	36	24	151	12	
L2ERH2442BR	1566	1668	1770	29	29.5	42	24	172	12	
L2ERH2448BR	1607	1723	1836	29	29.5	48	24	179	13	
L2ERH2454BR	1646	1776	1901	29	29.5	54	24	184	13	

**TECHNICAL INFORMATION**

**Technical Information**

Reception Desk:

All desks are shipped KD.

Center desk reception transaction top is available in "LP", "B" or "W" thickness to match the thickness and profile of worksurface edge.

All other exposed edges are banded with 3mm PVC.

Center unit is freestanding and can be connected on one or both sides with a return or bridge.

**Bridge unit is connected to the center unit to extend the return on either side.**

**This unit must be connected on both ends and nonhanded.**

Left or right hand unit is designed to extend the center unit. This unit must be connected on one end.

**Can be used as a freestanding unit or connected with surrounding bridge or corner surround.**

**Comes with transaction top.**

**DESKS • GUIDELINES FOR ORDERING PRODUCT**

**CODES:** The price list uses a numbering system with meaningful alphanumeric characters to create a simple-to-understand product number. This makes specifying the product much easier and more accurate.

**SPECIFICATION EXAMPLE OF A GALLERY RECEPTION DESK UNIT**

**PRODUCT CODE:** L2GR66  
 L2 = New Licence  
 G = Gallery  
 R = Reception  
 66 = Size: Width

**OPTIONS:**  
 Top: LP - LP (Low Pressure Laminate) Thickness 1"  
 HP B - B Thickness 1 1/16"  
 HP W - W Thickness 1 7/16"

Top Finish Laminate: Choose Color

Top PVC Edging: Choose Color

Chassis Laminate: Choose Color

Chassis PVC Edging: Choose Color

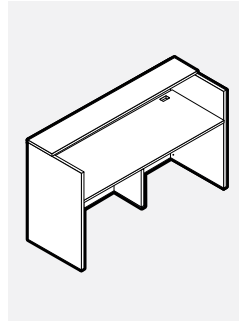

**L2GR • Gallery Reception Desk**

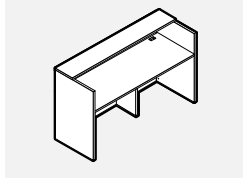

- Two grommets installed TL/TR.

PRODUCT CODE	FINISH			SIZE/INCHES				WEIGHT LBS	VOL FT <sup>3</sup>
	LP	B	W	H (LP/B)	H (W)	W	D		
L2GR66	1686	2115	2353	42.315	42.750	66	25	149	15
L2GR72	1771	2238	2494	42.315	42.750	72	25	163	17
L2GR78	1858	2358	2639	42.315	42.750	78	25	166	18
L2GR84	1943	2479	2780	42.315	42.750	84	25	171	20
L2GR96	2117	2725	3067	42.315	42.750	96	25	178	23

**L2GB • Gallery Bridge**

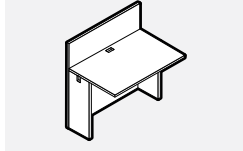

- One grommet installed TC.

PRODUCT CODE	FINISH			SIZE/INCHES				WEIGHT LBS	VOL FT <sup>3</sup>
	LP	B	W	H (LP/B)	H (W)	W	D		
L2GB42	751	946	1029	41.315	41.315	42	25	79	10
L2GB48	819	1010	1101	41.315	41.315	48	25	86	12
L2GB54	889	1101	1209	41.315	41.315	54	25	95	13
L2GB60	957	1191	1306	41.315	41.315	60	25	101	14

**L2GR-L • Gallery Left Return**

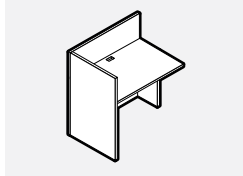

- One grommet installed TC.

PRODUCT CODE	FINISH			SIZE/INCHES				WEIGHT LBS	VOL FT <sup>3</sup>
	LP	B	W	H (LP/B)	H (W)	W	D		
L2GR36L	840	994	1064	41.315	41.315	36	25	90	9
L2GR42L	910	1084	1170	41.315	41.315	42	25	97	11
L2GR48L	977	1176	1272	41.315	41.315	48	25	106	13
L2GR54L	1046	1265	1376	41.315	41.315	54	25	119	14
L2GR60L	1115	1355	1478	41.315	41.315	60	25	132	16

**L2GR-R • Gallery Right Return**

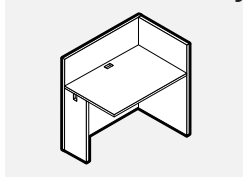

- One grommet installed TC.

PRODUCT CODE	FINISH			SIZE/INCHES				WEIGHT LBS	VOL FT <sup>3</sup>
	LP	B	W	H (LP/B)	H (W)	W	D		
L2GR36R	840	994	1064	41.315	41.315	36	25	90	9
L2GR42R	910	1084	1170	41.315	41.315	42	25	97	11
L2GR48R	977	1176	1272	41.315	41.315	48	25	106	13
L2GR54R	1046	1265	1376	41.315	41.315	54	25	119	14
L2GR60R	1115	1355	1478	41.315	41.315	60	25	132	16

**L2GD • Gallery Desk Decorative Panel**

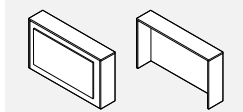

Front Back

- To be used in conjunction with a 66", 72" or 84" rectangular desk shell.
- Decorative Panel is high pressure laminate.

PRODUCT CODE	FINISH			SIZE/INCHES				WEIGHT LBS	VOL FT <sup>3</sup>
	LP	B	W	H (LP/B)	H (W)	W	D		
L2GD66	2077	2257	2450	42.315	42.750	68.25	12	99	20
L2GD72	2358	2564	2789	42.315	42.750	74.25	12	113	22
L2GD84	2531	2762	3007	42.315	42.750	86.25	12	117	25

**L2GDP • Gallery Desk With Pigeon Holes and Decorative Panel**

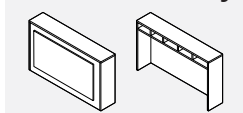

Front Back

- To be used in conjunction with a 66", 72" or 84" rectangular desk shell.
- Decorative Panel is high pressure laminate.

PRODUCT CODE	FINISH			SIZE/INCHES				WEIGHT LBS	VOL FT <sup>3</sup>
	LP	B	W	H (LP/B)	H (W)	W	D		
L2GDP66	2195	2391	2590	42.315	42.750	68.25	12	99	20
L2GDP72	2451	2721	2951	42.315	42.750	74.25	12	113	22
L2GDP84	2639	2940	3197	42.315	42.750	86.25	12	117	25

**L2GRKIT • Reception Kit Gallery**

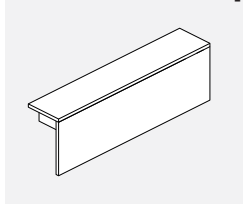

- Unit to be placed on L2DR or L2CRS Desk Shell

PRODUCT CODE	FINISH			SIZE/INCHES				WEIGHT LBS	VOL FT <sup>3</sup>
	LP	B	W	H (LP/B)	H (W)	W	D		
L2GRKIT36H36	555	588	610	18.37	18.75	36	12	68	1.50
L2GRKIT42H36	606	639	671	18.37	18.75	42	12	79	1.75
L2GRKIT48H36	659	705	733	18.37	18.75	48	12	90	2.00
L2GRKIT54H36	711	760	795	18.37	18.75	54	12	101	2.25
L2GRKIT60H36	763	820	857	18.37	18.75	60	12	113	2.50
L2GRKIT36H42	616	675	700	24.37	24.75	36	12	68	1.50
L2GRKIT42H42	678	748	772	24.37	24.75	42	12	79	1.75
L2GRKIT48H42	740	816	849	24.37	24.75	48	12	90	2.00
L2GRKIT54H42	800	894	950	24.37	24.75	54	12	101	2.25
L2GRKIT60H42	863	961	1000	24.37	24.75	60	12	113	2.50

**TECHNICAL INFORMATION**

- All Desks and connecting shells are Shipped knocked down (KD).
- All connecting units must be connected to an adjoining worksurface where there is either no end gable or a narrow gable with flat brackets.
- Gables & partial gables are interchangeable.
- All bottom edges are edge banded.
- Each shell allows for grommet (BG5) to be specified at no upcharge. Please see general information (Section A) for location.

**DESKS • GUIDELINES FOR ORDERING PRODUCT**

**CODES:** The price list uses a numbering system with meaningful alphanumeric characters to create a simple-to-understand product number. This makes specifying the product much easier and more accurate.

**SPECIFICATION EXAMPLE OF A DESK UNIT**

**PRODUCT CODE:** L2DR3060  
 L2 = New Licence  
 D = Desk  
 R = Rectangular  
 3060 = Size: Depth x Width

**OPTIONS:**  
 Top: LP - LP (Low Pressure Laminate) Thickness 1"  
 HP B - B Thickness 1 1/16"  
 HP W - W Thickness 1 7/16"

Top Finish Laminate: Choose Color  
 Top PVC Edging: Choose Color  
 Chassis Laminate: Choose Color  
 Chassis PVC Edging: Choose Color

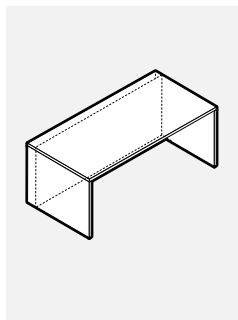

**SPECIFICATION EXAMPLE OF A CONNECTING RETURN UNIT**

**PRODUCT CODE:** L2RCH2030R  
 L2 = New Licence  
 R = Return  
 C = Connecting  
 H = Half Back Panel  
 2030 = Size: Depth x Width  
 R = Connecting on Right

**OPTIONS:**  
 Top: LP - LP (Low Pressure Laminate) Thickness 1"  
 HP B - B Thickness 1 1/16"  
 HP W - W Thickness 1 7/16"

Top Finish Laminate: Choose Color  
 Top PVC Edging: Choose Color  
 Chassis Laminate: Choose Color  
 Chassis PVC Edging: Choose Color

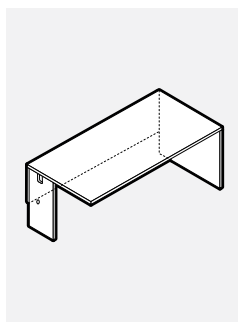



**L2DR • Rectangular Desk, Recessed Modesty**

• All recessed modesties are inset 6" from the visitor edge.

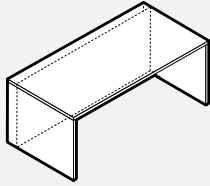

PRODUCT CODE	FINISH			SIZE/INCHES				WEIGHT LBS	VOL FT <sup>3</sup>
	LP	B	W	H(LP/B)	H(W)	W	D		
L2DR3060	1095	1338	1504	29	29.5	60	30	136	6
L2DR3066	1153	1418	1598	29	29.5	66	30	145	7
L2DR3072	1211	1495	1691	29	29.5	72	30	155	7
L2DR3078	1268	1575	1783	29	29.5	78	30	175	9
L2DR3084	1335	1661	1888	29	29.5	84	30	185	10
L2DR3660	1221	1505	1695	29	29.5	60	36	155	7
L2DR3666	1284	1594	1802	29	29.5	66	36	165	9
L2DR3672	1346	1684	1906	29	29.5	72	36	176	9
L2DR3678	1408	1771	2013	29	29.5	78	36	197	11
L2DR3684	1479	1868	2125	29	29.5	84	36	208	12

**L2DB • Bowfront Desk, Recessed Modesty**

• All recessed modesties are inset 6" from the visitor edge.

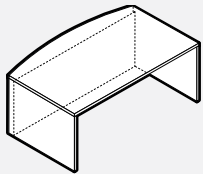

PRODUCT CODE	FINISH			SIZE/INCHES				WEIGHT LBS	VOL FT <sup>3</sup>
	LP	B	W	H(LP/B)	H(W)	W	D		
L2DB3060	1169	1450	1650	29	29.5	60	36	155	7
L2DB3066	1230	1540	1755	29	29.5	66	36	165	9
L2DB3072	1294	1629	1861	29	29.5	72	36	176	9
L2DB3078	1356	1720	1968	29	29.5	78	36	197	11
L2DB3084	1429	1815	2080	29	29.5	84	36	208	12
L2DB3660	1294	1618	1844	29	29.5	60	42	155	7
L2DB3666	1362	1720	1961	29	29.5	66	42	165	9
L2DB3672	1430	1815	2077	29	29.5	72	42	176	9
L2DB3678	1500	1915	2192	29	29.5	78	42	197	11
L2DB3684	1575	2022	2319	29	29.5	84	42	208	12

**L2CRS • Credenza Shell, Full End Gables on Both Sides and Flush Back**

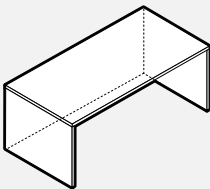

PRODUCT CODE	FINISH			SIZE/INCHES				WEIGHT LBS	VOL FT <sup>3</sup>
	LP	B	W	H(LP/B)	H(W)	W	D		
L2CRS2024	646	739	803	29	29.5	24	20	68	3
L2CRS2030	700	808	886	29	29.5	30	20	77	3
L2CRS2036	752	876	970	29	29.5	36	20	87	3
L2CRS2042	804	949	1053	29	29.5	42	20	94	3
L2CRS2048	857	1018	1135	29	29.5	48	20	102	4
L2CRS2054	908	1089	1219	29	29.5	54	20	109	4
L2CRS2060	970	1170	1310	29	29.5	60	20	118	4
L2CRS2066	1024	1236	1392	29	29.5	66	20	127	6
L2CRS2072	1076	1308	1475	29	29.5	72	20	135	6
L2CRS2078	1128	1380	1558	29	29.5	78	20	151	7
L2CRS2084	1187	1457	1650	29	29.5	84	20	160	8
L2CRS2424	671	766	837	29	29.5	24	24	68	3
L2CRS2430	728	840	922	29	29.5	30	24	77	3
L2CRS2436	783	912	1010	29	29.5	36	24	87	3
L2CRS2442	836	986	1095	29	29.5	42	24	94	3
L2CRS2448	892	1059	1181	29	29.5	48	24	102	4
L2CRS2454	945	1132	1267	29	29.5	54	24	109	4
L2CRS2460	1010	1215	1364	29	29.5	60	24	118	4
L2CRS2466	1064	1289	1448	29	29.5	66	24	127	6
L2CRS2472	1119	1358	1536	29	29.5	72	24	135	6
L2CRS2478	1173	1434	1619	29	29.5	78	24	151	7
L2CRS2484	1234	1515	1716	29	29.5	84	24	160	8
L2CRS3030	798	928	1022	29	29.5	30	30	90	3
L2CRS3036	854	1010	1118	29	29.5	36	30	99	3
L2CRS3042	912	1089	1211	29	29.5	42	30	109	4
L2CRS3048	970	1181	1305	29	29.5	48	30	119	4
L2CRS3054	1027	1248	1398	29	29.5	54	30	127	6
L2CRS3060	1095	1338	1504	29	29.5	60	30	136	6
L2CRS3066	1153	1418	1598	29	29.5	66	30	145	7
L2CRS3072	1211	1495	1691	29	29.5	72	30	155	7
L2CRS3078	1268	1575	1783	29	29.5	78	30	175	9
L2CRS3084	1335	1661	1888	29	29.5	84	30	185	10

**L2CRSH • Credenza Shell, Flush Back, Cut-Out Modesty, Full End Gables on Both Sides**

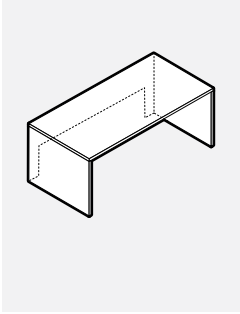

PRODUCT CODE	FINISH LP	B	W	SIZE / INCHES				WEIGHT LBS	VOL FT <sup>3</sup>
				H (LP/B)	H (W)	W	D		
L2CRSH2030	626	729	811	29	29.5	30	20	77	3
L2CRSH2036	668	787	878	29	29.5	36	20	87	3
L2CRSH2042	703	841	949	29	29.5	42	20	94	3
L2CRSH2048	743	898	1015	29	29.5	48	20	102	4
L2CRSH2054	781	954	1084	29	29.5	54	20	109	4
L2CRSH2060	829	1018	1161	29	29.5	60	20	118	4
L2CRSH2066	867	1073	1229	29	29.5	66	20	127	6
L2CRSH2072	907	1130	1297	29	29.5	72	20	135	6
L2CRSH2078	944	1184	1366	29	29.5	78	20	151	7
L2CRSH2084	992	1251	1442	29	29.5	84	20	160	8
L2CRSH2430	649	773	844	29	29.5	30	24	77	3
L2CRSH2436	691	819	914	29	29.5	36	24	87	3
L2CRSH2442	733	874	984	29	29.5	42	24	94	3
L2CRSH2448	771	932	1056	29	29.5	48	24	102	4
L2CRSH2454	811	992	1128	29	29.5	54	24	109	4
L2CRSH2460	860	1059	1210	29	29.5	60	24	118	4
L2CRSH2466	902	1116	1278	29	29.5	66	24	127	6
L2CRSH2472	941	1176	1349	29	29.5	72	24	135	6
L2CRSH2478	981	1232	1423	29	29.5	78	24	151	7
L2CRSH2484	1030	1300	1501	29	29.5	84	24	160	8
L2CRSH3030	724	853	945	29	29.5	30	30	90	3
L2CRSH3036	766	918	1026	29	29.5	36	30	99	3
L2CRSH3042	813	982	1105	29	29.5	42	30	109	4
L2CRSH3048	857	1048	1184	29	29.5	48	30	119	4
L2CRSH3054	900	1113	1264	29	29.5	54	30	127	6
L2CRSH3060	944	1177	1345	29	29.5	60	30	139	6
L2CRSH3066	986	1245	1425	29	29.5	66	30	145	7
L2CRSH3072	1031	1308	1504	29	29.5	72	30	155	7
L2CRSH3078	1076	1376	1583	29	29.5	78	30	175	9
L2CRSH3084	1119	1437	1661	29	29.5	84	30	185	10

**L2RC-R • Return, Connecting Right, Full Gable on Right and Narrow Gable on Left**

Units are non-handed. They can be configured as either lefts or rights.

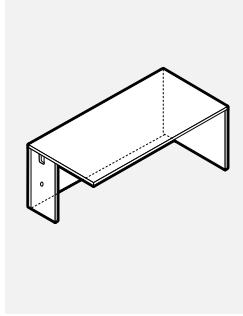

PRODUCT CODE	FINISH			SIZE/INCHES				WEIGHT LBS	VOL FT <sup>3</sup>
	LP	B	W	H(LP/B)	H(W)	W	D		
L2RC2024R	606	697	762	29	29.5	24	20	64	3
L2RC2030R	663	768	851	29	29.5	30	20	69	3
L2RC2036R	719	843	938	29	29.5	36	20	79	3
L2RC2042R	776	918	1021	29	29.5	42	20	86	3
L2RC2048R	832	992	1110	29	29.5	48	20	95	4
L2RC2054R	886	1065	1194	29	29.5	54	20	102	4
L2RC2060R	957	1155	1297	29	29.5	60	20	110	4
L2RC2066R	1015	1229	1385	29	29.5	66	20	119	6
L2RC2072R	1076	1308	1475	29	29.5	72	20	128	6
L2RC2078R	1132	1383	1563	29	29.5	78	20	143	7
L2RC2084R	1187	1454	1650	29	29.5	84	20	152	8
L2RC2424R	631	724	794	29	29.5	24	24	64	3
L2RC2430R	691	799	883	29	29.5	30	24	69	3
L2RC2436R	749	876	973	29	29.5	36	24	79	3
L2RC2442R	806	954	1063	29	29.5	42	24	86	3
L2RC2448R	865	1030	1155	29	29.5	48	24	95	4
L2RC2454R	922	1110	1245	29	29.5	54	24	102	4
L2RC2460R	998	1203	1349	29	29.5	60	24	110	4
L2RC2466R	1056	1278	1441	29	29.5	66	24	119	6
L2RC2472R	1119	1358	1536	29	29.5	72	24	128	6
L2RC2478R	1176	1436	1624	29	29.5	78	24	143	7
L2RC2484R	1234	1515	1715	29	29.5	84	24	152	8
L2RC3030R	752	881	976	29	29.5	30	30	83	3
L2RC3036R	813	965	1073	29	29.5	36	30	91	3
L2RC3042R	874	1049	1172	29	29.5	42	30	101	4
L2RC3048R	937	1132	1268	29	29.5	48	30	111	4
L2RC3054R	998	1215	1366	29	29.5	54	30	119	6
L2RC3060R	1073	1313	1483	29	29.5	60	30	129	6
L2RC3066R	1135	1396	1578	29	29.5	66	30	138	7
L2RC3072R	1203	1486	1683	29	29.5	72	30	147	7
L2RC3078R	1267	1569	1880	29	29.5	78	30	167	9
L2RC3084R	1326	1652	1984	29	29.5	84	30	177	10
L2RC3660R	1161	1445	1634	29	29.5	60	36	145	7
L2RC3666R	1229	1537	1743	29	29.5	66	36	157	9
L2RC3672R	1300	1636	1857	29	29.5	72	36	169	9
L2RC3678R	1367	1727	1968	29	29.5	78	36	190	11
L2RC3684R	1432	1819	2077	29	29.5	84	36	201	12

**L2RCH-R • Half Modesty Return, Connecting Right, Full Gable on Right and Narrow Gable on Left**

• Units are non-handed. They can be configured as either lefts or rights.

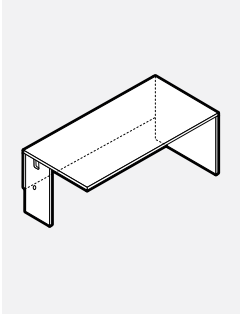

PRODUCT CODE	FINISH LP	B	W	SIZE / INCHES			WEIGHT LBS	VOL FT <sup>3</sup>	
				H (LP/B)	H (W)	D			
L2RCH2024R	539	643	713	29	29.5	24	20	55	3
L2RCH2030R	579	703	784	29	29.5	30	20	57	3
L2RCH2036R	621	763	857	29	29.5	36	20	65	3
L2RCH2042R	659	819	929	29	29.5	42	20	69	3
L2RCH2048R	700	880	999	29	29.5	48	20	76	4
L2RCH2054R	741	938	1070	29	29.5	54	20	81	4
L2RCH2060R	794	1014	1162	29	29.5	60	20	86	4
L2RCH2066R	836	1070	1230	29	29.5	66	20	92	6
L2RCH2072R	878	1138	1308	29	29.5	72	20	99	6
L2RCH2078R	918	1196	1342	29	29.5	78	20	112	7
L2RCH2084R	960	1254	1454	29	29.5	84	20	119	8
L2RCH2424R	558	843	741	29	29.5	24	24	56	3
L2RCH2430R	600	729	815	29	29.5	30	24	57	3
L2RCH2436R	644	792	891	29	29.5	36	24	65	3
L2RCH2442R	686	853	966	29	29.5	42	24	69	3
L2RCH2448R	728	913	1041	29	29.5	48	24	76	4
L2RCH2454R	768	976	1113	29	29.5	54	24	81	4
L2RCH2460R	829	1054	1208	29	29.5	60	24	86	4
L2RCH2466R	869	1113	1280	29	29.5	66	24	92	6
L2RCH2472R	914	1180	1360	29	29.5	72	24	99	6
L2RCH2478R	956	1245	1436	29	29.5	78	24	112	7
L2RCH2484R	998	1305	1511	29	29.5	84	24	119	8
L2RCH3030R	668	817	913	29	29.5	30	30	77	3
L2RCH3036R	712	886	998	29	29.5	36	30	83	3
L2RCH3042R	757	954	1081	29	29.5	42	30	87	4
L2RCH3048R	804	1024	1166	29	29.5	48	30	92	4
L2RCH3054R	851	1091	1251	29	29.5	54	30	98	6
L2RCH3060R	911	1176	1349	29	29.5	60	30	105	6
L2RCH3066R	956	1248	1432	29	29.5	66	30	111	7
L2RCH3072R	1005	1317	1520	29	29.5	72	30	119	7
L2RCH3078R	1052	1387	1694	29	29.5	78	30	136	9
L2RCH3084R	1097	1454	1780	29	29.5	84	30	144	10
L2RCH3660R	998	1310	1456	29	29.5	60	36	123	7
L2RCH3666R	1049	1389	1601	29	29.5	66	36	129	9
L2RCH3672R	1102	1473	1701	29	29.5	72	36	141	9
L2RCH3678R	1155	1550	1797	29	29.5	78	36	154	11
L2RCH3684R	1207	1561	1891	29	29.5	84	36	162	12

**L2RC-L • Return, Connecting Left, Full Gable on Left and Narrow Gable on Right**

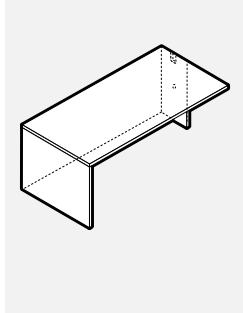

• Units are non-handed. They can be configured as either lefts or rights.

PRODUCT CODE	FINISH			SIZE / INCHES				WEIGHT LBS	VOL FT <sup>3</sup>
	LP	B	W	H (LP/B)	H (W)	W	D		
L2RC2024L	606	697	762	29	29.5	24	20	64	3
L2RC2030L	663	768	851	29	29.5	30	20	69	3
L2RC2036L	719	843	938	29	29.5	36	20	79	3
L2RC2042L	776	918	1021	29	29.5	42	20	86	3
L2RC2048L	832	992	1110	29	29.5	48	20	95	4
L2RC2054L	886	1065	1194	29	29.5	54	20	102	4
L2RC2060L	957	1155	1297	29	29.5	60	20	110	4
L2RC2066L	1015	1229	1385	29	29.5	66	20	119	6
L2RC2072L	1076	1308	1475	29	29.5	72	20	128	6
L2RC2078L	1132	1383	1563	29	29.5	78	20	143	7
L2RC2084L	1187	1454	1650	29	29.5	84	20	152	8
L2RC2424L	631	724	794	29	29.5	24	24	64	3
L2RC2430L	691	799	883	29	29.5	30	24	69	3
L2RC2436L	749	876	973	29	29.5	36	24	79	3
L2RC2442L	806	954	1063	29	29.5	42	24	86	3
L2RC2448L	865	1030	1155	29	29.5	48	24	95	4
L2RC2454L	922	1110	1245	29	29.5	54	24	102	4
L2RC2460L	998	1203	1385	29	29.5	60	24	110	4
L2RC2466L	1056	1278	1441	29	29.5	66	24	119	6
L2RC2472L	1119	1358	1536	29	29.5	72	24	128	6
L2RC2478L	1177	1436	1624	29	29.5	78	24	143	7
L2RC2484L	1234	1515	1715	29	29.5	84	24	152	8
L2RC3030L	752	881	976	29	29.5	30	30	83	3
L2RC3036L	813	965	1073	29	29.5	36	30	91	3
L2RC3042L	874	1049	1172	29	29.5	42	30	101	4
L2RC3048L	937	1132	1268	29	29.5	48	30	111	4
L2RC3054L	998	1215	1366	29	29.5	54	30	119	6
L2RC3060L	1073	1313	1483	29	29.5	60	30	129	6
L2RC3066L	1135	1396	1578	29	29.5	66	30	138	7
L2RC3072L	1203	1486	1683	29	29.5	72	30	147	7
L2RC3078L	1263	1569	1880	29	29.5	78	30	167	9
L2RC3084L	1326	1652	1984	29	29.5	84	30	177	10
L2RC3660L	1161	1445	1634	29	29.5	60	36	145	7
L2RC3666L	1229	1537	1743	29	29.5	66	36	157	9
L2RC3672L	1300	1636	1857	29	29.5	72	36	169	9
L2RC3678L	1367	1727	1968	29	29.5	78	36	190	11
L2RC3684L	1432	1819	2077	29	29.5	84	36	201	12

**L2RCH-L • Half Modesty Return, Connecting Left, Full Gable on Left and Narrow Gable on Right**

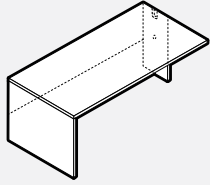

• Units are non-handed. They can be configured as either lefts or rights.

PRODUCT CODE	FINISH			SIZE / INCHES				WEIGHT LBS	VOL FT <sup>3</sup>
	LP	B	W	H (LP/B)	H (W)	W	D		
L2RCH2024L	539	643	713	29	29.5	24	20	55	3
L2RCH2030L	579	703	784	29	29.5	30	20	57	3
L2RCH2036L	621	763	857	29	29.5	36	20	65	3
L2RCH2042L	659	819	929	29	29.5	42	20	69	3
L2RCH2048L	700	880	999	29	29.5	48	20	76	4
L2RCH2054L	741	938	1070	29	29.5	54	20	81	4
L2RCH2060L	794	1014	1162	29	29.5	60	20	86	4
L2RCH2066L	836	1070	1230	29	29.5	66	20	92	5
L2RCH2072L	878	1138	1308	29	29.5	72	20	99	5
L2RCH2078L	918	1196	1342	29	29.5	78	20	112	6
L2RCH2084L	960	1254	1454	29	29.5	84	20	119	7
L2RCH2424L	558	843	741	29	29.5	24	24	56	3
L2RCH2430L	600	729	815	29	29.5	30	24	57	3
L2RCH2436L	644	792	891	29	29.5	36	24	65	3
L2RCH2442L	686	853	966	29	29.5	42	24	69	3
L2RCH2448L	728	913	1041	29	29.5	48	24	76	4
L2RCH2454L	768	976	1113	29	29.5	54	24	81	4
L2RCH2460L	829	1054	1208	29	29.5	60	24	86	4
L2RCH2466L	869	1113	1280	29	29.5	66	24	92	5
L2RCH2472L	914	1180	1360	29	29.5	72	24	99	5
L2RCH2478L	956	1245	1436	29	29.5	78	24	112	6
L2RCH2484L	998	1305	1511	29	29.5	84	24	119	7
L2RCH3030L	668	817	913	29	29.5	30	30	77	3
L2RCH3036L	712	886	998	29	29.5	36	30	83	3
L2RCH3042L	757	954	1081	29	29.5	42	30	87	4
L2RCH3048L	804	1024	1166	29	29.5	48	30	92	4
L2RCH3054L	851	1091	1251	29	29.5	54	30	98	5
L2RCH3060L	911	1176	1349	29	29.5	60	30	105	5
L2RCH3066L	956	1248	1432	29	29.5	66	30	111	6
L2RCH3072L	1005	1317	1520	29	29.5	72	30	119	6
L2RCH3078L	1052	1387	1694	29	29.5	78	30	136	8
L2RCH3084L	1097	1454	1780	29	29.5	84	30	144	9
L2RCH3660L	998	1310	1456	29	29.5	60	36	123	6
L2RCH3666L	1049	1389	1601	29	29.5	66	36	129	8
L2RCH3672L	1102	1473	1701	29	29.5	72	36	141	8
L2RCH3678L	1155	1550	1797	29	29.5	78	36	154	10
L2RCH3684L	1207	1561	1891	29	29.5	84	36	162	11

**L2RC-C • Return, Connecting Narrow Gables on Both Sides**

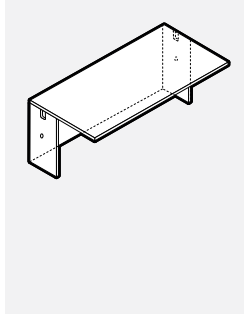

PRODUCT CODE	FINISH		SIZE / INCHES					WEIGHT		VOL FT <sup>3</sup>
	LP	B	W	H (LP/B)	H (W)	W	D	LBS		
L2RC2024C	539	626	692	29	29.5	24	20	56	3	
L2RC2030C	595	671	749	29	29.5	30	20	62	3	
L2RC2036C	649	741	832	29	29.5	36	20	72	3	
L2RC2042C	707	811	912	29	29.5	42	20	78	3	
L2RC2048C	762	881	995	29	29.5	48	20	87	4	
L2RC2054C	819	950	1076	29	29.5	54	20	95	4	
L2RC2060C	892	1036	1173	29	29.5	60	20	102	4	
L2RC2066C	949	1105	1257	29	29.5	66	20	111	6	
L2RC2072C	1008	1180	1343	29	29.5	72	20	120	6	
L2RC2078C	1064	1251	1425	29	29.5	78	20	135	7	
L2RC2084C	1119	1319	1507	29	29.5	84	20	144	8	
L2RC2424C	562	649	719	29	29.5	24	24	56	3	
L2RC2430C	621	698	781	29	29.5	30	24	62	3	
L2RC2436C	679	771	865	29	29.5	36	24	72	3	
L2RC2442C	736	843	950	29	29.5	42	24	78	3	
L2RC2448C	794	916	1035	29	29.5	48	24	87	4	
L2RC2454C	853	989	1119	29	29.5	54	24	95	4	
L2RC2460C	925	1078	1221	29	29.5	60	24	102	4	
L2RC2466C	984	1151	1305	29	29.5	66	24	111	6	
L2RC2472C	1049	1226	1396	29	29.5	72	24	120	6	
L2RC2478C	1107	1300	1483	29	29.5	78	24	135	7	
L2RC2484C	1166	1373	1566	29	29.5	84	24	144	8	
L2RC3030C	696	820	914	29	29.5	30	30	75	3	
L2RC3036C	754	903	1011	29	29.5	36	30	84	3	
L2RC3042C	815	986	1111	29	29.5	42	30	94	4	
L2RC3048C	876	1021	1155	29	29.5	48	30	103	4	
L2RC3054C	940	1101	1247	29	29.5	54	30	116	6	
L2RC3060C	1015	1196	1354	29	29.5	60	30	121	6	
L2RC3066C	1078	1272	1446	29	29.5	66	30	130	7	
L2RC3072C	1143	1356	1545	29	29.5	72	30	140	7	
L2RC3078C	1207	1436	1637	29	29.5	78	30	160	9	
L2RC3084C	1267	1512	1731	29	29.5	84	30	169	10	

**L2RCH-C • Half Modesty Return, Connecting Narrow Gables on Both Sides**

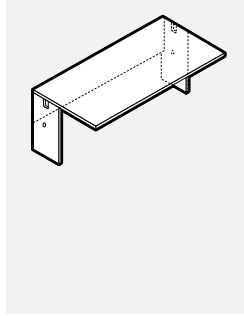

PRODUCT CODE	FINISH LP	B	W	SIZE / INCHES			D	WEIGHT LBS	VOL FT <sup>3</sup>
				H (LP/B)	H (W)	W			
L2RCH2024C	471	554	622	29	29.5	24	20	46	3
L2RCH2030C	513	612	691	29	29.5	30	20	50	3
L2RCH2036C	551	670	739	29	29.5	36	20	57	3
L2RCH2042C	592	725	832	29	29.5	42	20	62	3
L2RCH2048C	633	784	900	29	29.5	48	20	68	4
L2RCH2054C	649	840	970	29	29.5	54	20	74	4
L2RCH2060C	707	914	1057	29	29.5	60	20	78	4
L2RCH2066C	749	970	1127	29	29.5	66	20	85	6
L2RCH2072C	792	1031	1199	29	29.5	72	20	91	6
L2RCH2078C	832	1090	1270	29	29.5	78	20	105	7
L2RCH2084C	873	1145	1342	29	29.5	84	20	111	8
L2RCH2424C	491	577	646	29	29.5	24	24	46	3
L2RCH2430C	534	637	719	29	29.5	30	24	50	3
L2RCH2436C	576	696	792	29	29.5	36	24	57	3
L2RCH2442C	617	754	865	29	29.5	42	24	62	3
L2RCH2448C	658	815	938	29	29.5	48	24	68	4
L2RCH2454C	679	874	1010	29	29.5	54	24	74	4
L2RCH2460C	736	950	1099	29	29.5	60	24	78	4
L2RCH2466C	778	1010	1172	29	29.5	66	24	85	6
L2RCH2472C	824	1073	1248	29	29.5	72	24	91	6
L2RCH2478C	865	1134	1319	29	29.5	78	24	105	7
L2RCH2484C	907	1191	1392	29	29.5	84	24	111	8
L2RCH3030C	608	734	829	29	29.5	30	30	72	3
L2RCH3036C	655	775	907	29	29.5	36	30	80	3
L2RCH3042C	700	865	986	29	29.5	42	30	85	4
L2RCH3048C	746	932	1069	29	29.5	48	30	90	4
L2RCH3054C	792	999	1151	29	29.5	54	30	95	6
L2RCH3060C	853	1081	1248	29	29.5	60	30	97	6
L2RCH3066C	898	1148	1332	29	29.5	66	30	103	7
L2RCH3072C	949	1221	1418	29	29.5	72	30	111	7
L2RCH3078C	994	1289	1452	29	29.5	78	30	129	9
L2RCH3084C	1038	1353	1577	29	29.5	84	30	136	10

**L2RCS • Return Connecting Swerve Left**

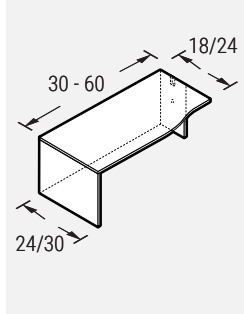

PRODUCT CODE	FINISH LP	B	W	SIZE / INCHES			D	WEIGHT LBS	VOL FT <sup>3</sup>
				H (LP/B)	H (W)	W			
L2RCS243018	729	840	977	29	29.5	30	24	70	2
L2RCS243618	787	914	1064	29	29.5	36	24	79	3
L2RCS244218	841	989	1151	29	29.5	42	24	88	3
L2RCS244818	898	1060	1234	29	29.5	48	24	97	4
L2RCS245418	954	1135	1321	29	29.5	54	24	106	4
L2RCS246018	1026	1225	1426	29	29.5	60	24	114	4
L2RCS303024	795	928	1135	29	29.5	30	30	81	3
L2RCS303624	857	1011	1176	29	29.5	36	30	91	3
L2RCS304224	918	1095	1273	29	29.5	42	30	109	4
L2RCS304824	979	1177	1372	29	29.5	48	30	119	4
L2RCS305424	1040	1262	1469	29	29.5	54	30	127	6
L2RCS306024	1102	1344	1566	29	29.5	60	30	136	6

**L2RCS • Return Connecting Swerve Right**

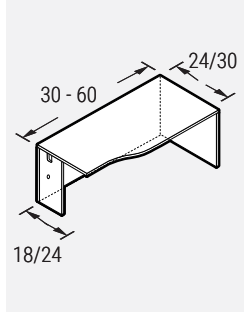

PRODUCT CODE	FINISH LP	B	W	SIZE / INCHES			D	WEIGHT LBS	VOL FT <sup>3</sup>
				H (LP/B)	H (W)	W			
L2RCS183024	729	840	977	29	29.9	30	24	70	2
L2RCS183624	787	914	1063	29	29.5	36	24	79	3
L2RCS184224	841	989	1151	29	29.5	42	24	88	3
L2RCS184824	898	1062	1234	29	29.5	48	24	97	4
L2RCS185424	954	1135	1321	29	29.5	54	24	106	4
L2RCS186024	1026	1225	1426	29	29.5	60	24	114	4
L2RCS243030	795	928	1078	29	29.5	30	30	81	3
L2RCS243630	857	1011	1176	29	29.5	36	30	91	3
L2RCS244230	918	1095	1273	29	29.5	42	30	109	4
L2RCS244830	979	1177	1372	29	29.5	48	30	119	4
L2RCS245430	1040	1262	1469	29	29.5	54	30	127	6
L2RCS246030	1102	1344	1566	29	29.5	60	30	136	6



**L2RCSH • Return Connecting Swerve Left With Half Modesty Panel**

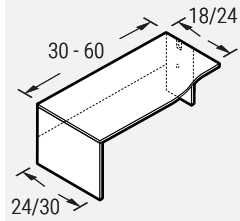

PRODUCT CODE	FINISH LP	B	W	SIZE/INCHES				WEIGHT LBS	VOL FT <sup>3</sup>
				H(LP/B)	H(W)	W	D		
L2RCSH243018	646	752	891	29	29.5	30	24	61	2
L2RCSH243618	686	808	957	29	29.5	36	24	65	3
L2RCSH244218	725	867	1027	29	29.5	42	24	72	3
L2RCSH244818	766	923	1099	29	29.5	48	24	77	4
L2RCSH245418	806	981	1169	29	29.5	54	24	84	4
L2RCSH246018	862	1056	1256	29	29.5	60	24	90	4
L2RCSH303024	711	840	992	29	29.5	30	30	78	3
L2RCSH303624	756	907	1072	29	29.5	36	30	88	3
L2RCSH304224	802	1004	1153	29	29.5	42	30	105	4
L2RCSH304824	848	1040	1232	29	29.5	48	30	114	4
L2RCSH305424	895	1107	1313	29	29.5	54	30	121	5
L2RCSH306024	940	1184	1394	29	29.5	60	30	130	5

**L2RCSH • Return Connecting Swerve Right With Half Modesty Panel**

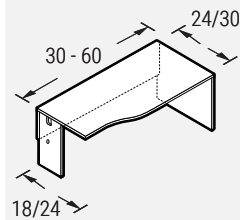

PRODUCT CODE	FINISH LP	B	W	SIZE/INCHES				WEIGHT LBS	VOL FT <sup>3</sup>
				H(LP/B)	H(W)	W	D		
L2RCSH183024	646	752	891	29	29.5	30	24	61	2
L2RCSH183624	686	808	957	29	29.5	36	24	65	3
L2RCSH184224	725	867	1027	29	29.5	42	24	72	3
L2RCSH184824	766	923	1099	29	29.5	48	24	77	4
L2RCSH185424	806	981	1169	29	29.5	54	24	84	4
L2RCSH186024	862	1056	1256	29	29.5	60	24	90	4
L2RCSH243030	711	840	992	29	29.5	30	30	78	3
L2RCSH243630	756	907	1072	29	29.5	36	30	88	3
L2RCSH244230	802	1004	1153	29	29.5	42	30	105	4
L2RCSH244830	848	1040	1232	29	29.5	48	30	114	4
L2RCSH245430	895	1107	1313	29	29.5	54	30	121	6
L2RCSH246030	940	1184	1394	29	29.5	60	30	130	6

**L2RCW • Return Connecting Wedge Left**

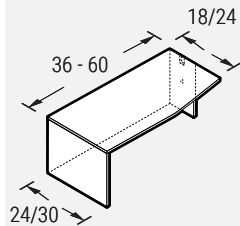

PRODUCT CODE	FINISH LP	B	W	SIZE/INCHES				WEIGHT LBS	VOL FT <sup>3</sup>
				H(LP/B)	H(W)	W	D		
L2RCW243018	729	840	977	29	29.5	30	24	70	2
L2RCW243618	787	914	1063	29	29.5	36	24	79	3
L2RCW244218	841	989	1151	29	29.5	42	24	88	3
L2RCW244818	898	1060	1234	29	29.5	48	24	97	4
L2RCW245418	954	1135	1321	29	29.5	54	24	106	4
L2RCW246018	1026	1225	1426	29	29.5	60	24	114	4
L2RCW303024	795	928	1078	29	29.5	30	30	81	3
L2RCW303624	857	1011	1176	29	29.5	36	30	91	3
L2RCW304224	918	1095	1272	29	29.5	42	30	109	4
L2RCW304824	981	1177	1373	29	29.5	48	30	119	4
L2RCW305424	1040	1261	1470	29	29.5	54	30	127	6
L2RCW306024	1102	1345	1566	29	29.5	60	30	136	6

**L2RCW • Return Connecting Wedge Right**

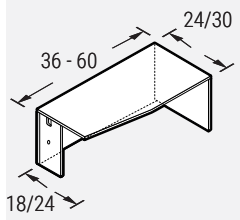

PRODUCT CODE	FINISH LP	B	W	SIZE/INCHES				WEIGHT LBS	VOL FT <sup>3</sup>
				H(LP/B)	H(W)	W	D		
L2RCW183024	729	840	976	29	29.5	30	24	70	2
L2RCW183624	787	914	1063	29	29.5	36	24	79	3
L2RCW184224	841	989	1150	29	29.5	42	24	88	3
L2RCW184824	898	1060	1234	29	29.5	48	24	97	4
L2RCW185424	954	1135	1321	29	29.5	54	24	106	4
L2RCW186024	1026	1225	1426	29	29.5	60	24	114	4
L2RCW243030	795	928	1078	29	29.5	30	30	81	3
L2RCW243630	857	1011	1176	29	29.5	36	30	91	3
L2RCW244230	918	1095	1272	29	29.5	42	30	109	4
L2RCW244830	981	1177	1373	29	29.5	48	30	119	4
L2RCW245430	1040	1261	1470	29	29.5	54	30	127	6
L2RCW246030	1102	1345	1566	29	29.5	60	30	136	6

**L2RCWH • Return Connecting Wedge Left With Half Modesty**

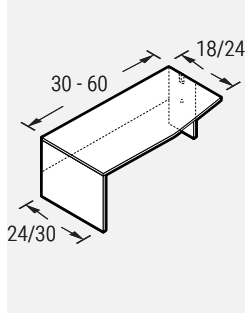

PRODUCT CODE	FINISH			SIZE/INCHES				WEIGHT		VOL FT <sup>3</sup>
	LP	B	W	H (LP/B)	H (W)	W	D	LBS		
L2RCWH243018	646	752	891	29	29.5	30	24	61	2	
L2RCWH243618	686	808	957	29	29.5	36	24	65	3	
L2RCWH244218	725	867	1027	29	29.5	42	24	72	3	
L2RCWH244818	766	923	1099	29	29.5	48	24	77	4	
L2RCWH245418	806	981	1169	29	29.5	54	24	84	4	
L2RCWH246018	862	1056	1256	29	29.5	60	24	90	4	
L2RCWH303024	711	840	992	29	29.5	30	30	78	3	
L2RCWH303624	756	907	1072	29	29.5	36	30	88	3	
L2RCWH304224	802	972	1153	29	29.5	42	30	105	4	
L2RCWH304824	848	1040	1232	29	29.5	48	30	114	4	
L2RCWH305424	895	1107	1313	29	29.5	54	30	121	6	
L2RCWH306024	940	1173	1394	29	29.5	60	30	130	6	

**L2RCWH • Return Connecting Wedge Right With Half Modesty**

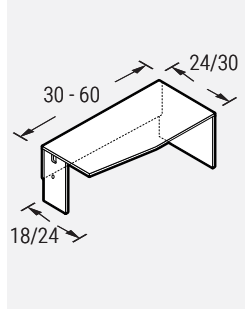

PRODUCT CODE	FINISH			SIZE/INCHES				WEIGHT		VOL FT <sup>3</sup>
	LP	B	W	H (LP/B)	H (W)	W	D	LBS		
L2RCWH183024	646	752	891	29	29.5	30	24	61	2	
L2RCWH183624	686	808	957	29	29.5	36	24	65	3	
L2RCWH184224	725	867	1027	29	29.5	42	24	72	3	
L2RCWH184824	766	923	1099	29	29.5	48	24	77	4	
L2RCWH185424	806	981	1169	29	29.5	54	24	84	4	
L2RCWH186024	862	1056	1256	29	29.5	60	24	90	4	
L2RCWH243030	711	840	992	29	29.5	30	30	78	3	
L2RCWH243630	756	907	1072	29	29.5	36	30	88	3	
L2RCWH244230	802	972	1153	29	29.5	42	30	105	4	
L2RCWH244830	848	1040	1232	29	29.5	48	30	114	4	
L2RCWH245430	895	1107	1313	29	29.5	54	30	121	6	
L2RCWH246030	940	1173	1394	29	29.5	60	30	130	6	

**L2ER-L • Executive Return Left**

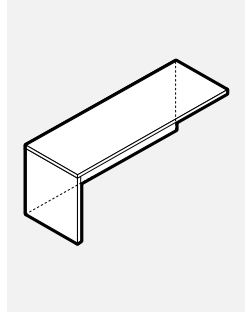

• Units are non-handed. They can be configured as either lefts or rights.

PRODUCT CODE	FINISH			SIZE/INCHES				WEIGHT		VOL FT <sup>3</sup>
	LP	B	W	H (LP/B)	H (W)	W	D	LBS		
L2ER2024L	484	567	633	29	29.5	24	20	25	3	
L2ER2030L	541	642	719	29	29.5	30	20	29	3	
L2ER2036L	600	722	816	29	29.5	36	20	32	3	
L2ER2042L	665	804	911	29	29.5	42	20	35	3	
L2ER2048L	722	876	998	29	29.5	48	20	37	4	
L2ER2054L	778	952	1084	29	29.5	54	20	40	4	
L2ER2060L	851	1040	1187	29	29.5	60	20	44	4	
L2ER2066L	907	1115	1272	29	29.5	66	20	46	6	
L2ER2072L	961	1188	1364	29	29.5	72	20	50	6	
L2ER2424L	504	592	658	29	29.5	24	24	25	3	
L2ER2430L	562	668	746	29	29.5	30	24	29	3	
L2ER2436L	626	750	851	29	29.5	36	24	32	3	
L2ER2442L	692	836	949	29	29.5	42	24	35	3	
L2ER2448L	750	912	1036	29	29.5	48	24	37	4	
L2ER2454L	808	989	1128	29	29.5	54	24	40	4	
L2ER2460L	883	1081	1232	29	29.5	60	24	44	4	
L2ER2466L	941	1161	1326	29	29.5	66	24	46	6	
L2ER2472L	999	1237	1421	29	29.5	72	24	50	6	

**L2ERH-L • Executive Return Left, Half Modesty**

• Units are non-handed. They can be configured as either lefts or rights.

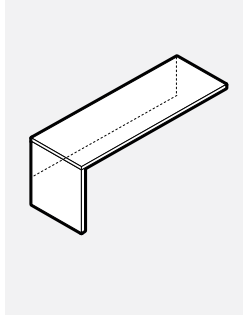

PRODUCT CODE	FINISH			SIZE/INCHES				WEIGHT LBS	VOL FT <sup>3</sup>
	LP	B	W	H (LP/B)	H(W)	W	D		
L2ERH2024L	419	497	562	29	29.5	24	20	25	3
L2ERH2030L	458	554	631	29	29.5	30	20	29	3
L2ERH2036L	601	625	719	29	29.5	36	20	32	3
L2ERH2042L	665	682	790	29	29.5	42	20	35	3
L2ERH2048L	722	741	860	29	29.5	48	20	37	4
L2ERH2054L	778	795	928	29	29.5	54	20	40	4
L2ERH2060L	851	870	1015	29	29.5	60	20	44	4
L2ERH2066L	905	925	1084	29	29.5	66	20	46	6
L2ERH2072L	961	984	1160	29	29.5	72	20	50	6
L2ERH2424L	433	517	584	29	29.5	24	24	25	3
L2ERH2430L	475	577	655	29	29.5	30	24	29	3
L2ERH2436L	530	648	749	29	29.5	36	24	32	3
L2ERH2442L	572	708	820	29	29.5	42	24	35	3
L2ERH2448L	615	768	895	29	29.5	48	24	37	4
L2ERH2454L	655	830	965	29	29.5	54	24	40	4
L2ERH2460L	712	903	1056	29	29.5	60	24	44	4
L2ERH2466L	754	964	1128	29	29.5	66	24	46	6
L2ERH2472L	795	1024	1208	29	29.5	72	24	50	6

**L2ER-R • Executive Return Right**

• Units are non-handed. They can be configured as either lefts or rights.

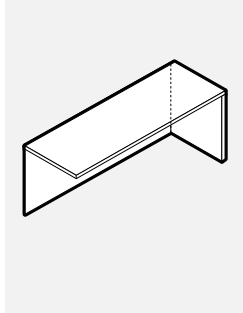

PRODUCT CODE	FINISH			SIZE/INCHES				WEIGHT LBS	VOL FT <sup>3</sup>
	LP	B	W	H (LP/B)	H(W)	W	D		
L2ER2024R	484	567	633	29	29.5	24	20	55	3
L2ER2030R	541	642	719	29	29.5	30	20	63	3
L2ER2036R	600	722	816	29	29.5	36	20	70	3
L2ER2042R	665	804	911	29	29.5	42	20	77	3
L2ER2048R	722	876	998	29	29.5	48	20	87	4
L2ER2054R	778	952	1084	29	29.5	54	20	92	4
L2ER2060R	851	1040	1187	29	29.5	60	20	102	4
L2ER2066R	907	1115	1272	29	29.5	66	20	110	6
L2ER2072R	961	1188	1364	29	29.5	72	20	119	6
L2ER2424R	504	592	658	29	29.5	24	24	55	3
L2ER2430R	562	668	746	29	29.5	30	24	63	3
L2ER2436R	626	750	851	29	29.5	36	24	70	3
L2ER2442R	692	836	949	29	29.5	42	24	77	3
L2ER2448R	750	912	1036	29	29.5	48	24	87	4
L2ER2454R	808	989	1128	29	29.5	54	24	92	4
L2ER2460R	883	1081	1232	29	29.5	60	24	102	4
L2ER2466R	941	1161	1326	29	29.5	66	24	110	6
L2ER2472R	999	1237	1421	29	29.5	72	24	119	6

**L2ERH-R • Executive Return Right, Half Modesty**

• Units are non-handed. They can be configured as either lefts or rights.

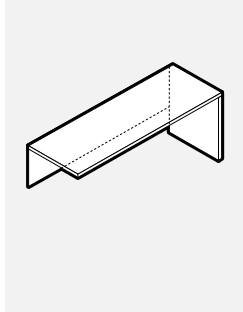

PRODUCT CODE	FINISH			SIZE/INCHES				WEIGHT LBS	VOL FT <sup>3</sup>
	LP	B	W	H (LP/B)	H(W)	W	D		
L2ERH2024R	419	497	562	29	29.5	24	20	45	3
L2ERH2030R	458	554	631	29	29.5	30	20	53	3
L2ERH2036R	601	625	719	29	29.5	36	20	62	3
L2ERH2042R	665	682	790	29	29.5	42	20	67	3
L2ERH2048R	722	741	860	29	29.5	48	20	77	4
L2ERH2054R	778	795	928	29	29.5	54	20	83	4
L2ERH2060R	851	870	1015	29	29.5	60	20	94	4
L2ERH2066R	905	925	1084	29	29.5	66	20	101	6
L2ERH2072R	961	984	1160	29	29.5	72	20	110	6
L2ERH2424R	433	517	584	29	29.5	24	24	45	3
L2ERH2430R	475	577	655	29	29.5	30	24	53	3
L2ERH2436R	530	648	749	29	29.5	36	24	62	3
L2ERH2442R	572	708	820	29	29.5	42	24	67	3
L2ERH2448R	615	768	895	29	29.5	48	24	77	4
L2ERH2454R	655	830	965	29	29.5	54	24	83	4
L2ERH2460R	712	903	1056	29	29.5	60	24	94	4
L2ERH2466R	754	964	1128	29	29.5	66	24	101	6
L2ERH2472R	795	1024	1208	29	29.5	72	24	110	6

**L2B • Bridge With Flush-Mounted Modesty**

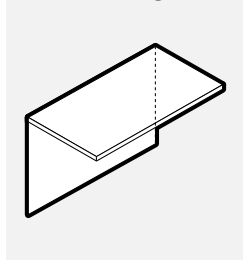

PRODUCT CODE	FINISH LP	B	W	SIZE / INCHES				WEIGHT LBS	VOL FT <sup>3</sup>
				H (LP/B)	H (W)	W	D		
L2B2024	334	409	476	29	29.5	24	20	39	2
L2B2030	389	482	563	29	29.5	30	20	42	3
L2B2036	449	563	658	29	29.5	36	20	68	3
L2B2042	506	637	745	29	29.5	42	20	77	3
L2B2048	562	711	832	29	29.5	48	20	86	4
L2B2054	619	787	918	29	29.5	54	20	94	4
L2B2424	347	426	496	29	29.5	24	24	39	2
L2B2430	405	502	588	29	29.5	30	24	44	3
L2B2436	469	584	684	29	29.5	36	24	68	3
L2B2442	525	663	776	29	29.5	42	24	77	3
L2B2448	584	741	865	29	29.5	48	24	86	4
L2B2454	642	816	954	29	29.5	54	24	94	4

**L2BH • Bridge With Flush-Mounted Half Modesty**

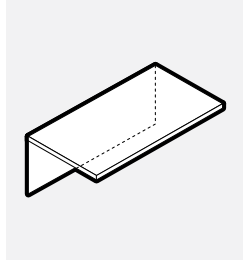

PRODUCT CODE	FINISH LP	B	W	SIZE / INCHES				WEIGHT LBS	VOL FT <sup>3</sup>
				H (LP/B)	H (W)	W	D		
L2BH2024	265	339	406	29	29.5	24	20	36	2
L2BH2030	306	395	475	29	29.5	30	20	36	2
L2BH2036	351	460	554	29	29.5	36	20	54	3
L2BH2042	389	517	625	29	29.5	42	20	61	3
L2BH2048	431	572	692	29	29.5	48	20	66	4
L2BH2054	471	631	762	29	29.5	54	20	72	4
L2BH2424	276	352	422	29	29.5	24	24	36	2
L2BH2430	318	410	492	29	29.5	30	24	42	3
L2BH2436	365	476	577	29	29.5	36	24	54	3
L2BH2442	406	538	648	29	29.5	42	24	61	3
L2BH2448	447	595	722	29	29.5	48	24	66	4
L2BH2454	489	655	794	29	29.5	54	24	72	4

**L2EC-R • Extended Corner Desk With 10" End Panel on Left, Full Modesty and Full Gable on Right**

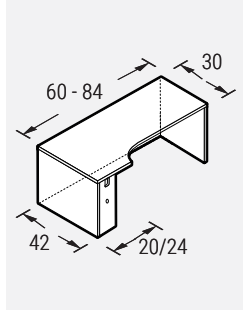

PRODUCT CODE	FINISH LP	B	W	SIZE / INCHES				WEIGHT LBS	VOL FT <sup>3</sup>
				H (LP/B)	H (W)	W	D		
<b>For 20" Return Connection</b>									
L2EC20426030R	1385	1713	1945	29	29.5	60	42	187	8
L2EC20426630R	1452	1814	2065	29	29.5	66	42	209	9
L2EC20427230R	1522	1910	2180	29	29.5	72	42	231	10
L2EC20427830R	1591	2011	2295	29	29.5	78	42	253	11
L2EC20428430R	1657	2107	2414	29	29.5	84	42	275	12
<b>For 24" Return Connection</b>									
L2EC24426030R	1385	1713	1945	29	29.5	60	42	187	8
L2EC24426630R	1452	1814	2065	29	29.5	66	42	209	9
L2EC24427230R	1522	1910	2180	29	29.5	72	42	231	10
L2EC24427830R	1591	2011	2295	29	29.5	78	42	253	11
L2EC24428430R	1657	2107	2414	29	29.5	84	42	275	12

**L2EC-L • Extended Corner Desk With 10" End Panel on Right, Full Modesty and Full Gable on Left**

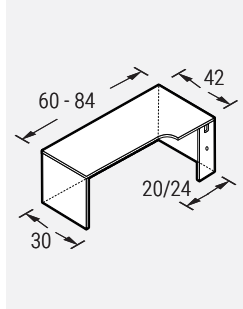

PRODUCT CODE	FINISH LP	B	W	SIZE / INCHES				WEIGHT LBS	VOL FT <sup>3</sup>
				H (LP/B)	H (W)	W	D		
<b>For 20" Return Connection</b>									
L2EC30604220L	1385	1713	1945	29	29.5	60	42	187	8
L2EC30664220L	1452	1814	2065	29	29.5	66	42	209	9
L2EC30724220L	1522	1910	2180	29	29.5	72	42	231	10
L2EC30784220L	1591	2011	2295	29	29.5	78	42	253	11
L2EC30844220L	1657	2107	2414	29	29.5	84	42	275	12
<b>For 24" Return Connection</b>									
L2EC30604224L	1385	1713	1945	29	29.5	60	42	187	8
L2EC30664224L	1452	1814	2065	29	29.5	66	42	209	9
L2EC30724224L	1522	1910	2180	29	29.5	72	42	231	10
L2EC30784224L	1591	2011	2295	29	29.5	78	42	253	11
L2EC30844224L	1657	2107	2414	29	29.5	84	42	275	12

**L2EC-R • Extended Corner Desk With 10" End Panel on Left, Full Modesty and Full Gable on Right**

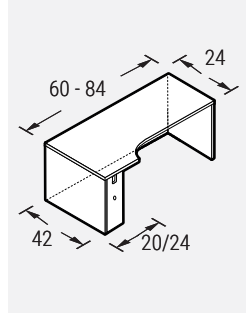

PRODUCT CODE	FINISH LP	B	W	SIZE/INCHES				WEIGHT LBS	VOL FT <sup>3</sup>
				H(LP/B)	H(W)	W	D		
<b>For 20" Return Connection</b>									
L2EC20426024R	1354	1686	1918	29	29.5	60	42	187	8
L2EC20426624R	1425	1783	2034	29	29.5	66	42	209	9
L2EC20427224R	1491	1882	2150	29	29.5	72	42	231	10
L2EC20427824R	1561	1981	2266	29	29.5	78	42	253	11
L2EC20428424R	1630	2079	2386	29	29.5	84	42	275	12
<b>For 24" Return Connection</b>									
L2EC24426024R	1354	1686	1918	29	29.5	60	42	187	8
L2EC24426624R	1425	1783	2034	29	29.5	66	42	209	9
L2EC24427224R	1491	1882	2150	29	29.5	72	42	231	10
L2EC24427824R	1561	1981	2266	29	29.5	78	42	253	11
L2EC24428424R	1630	2079	2386	29	29.5	84	42	275	12

**L2EC-L • Extended Corner Desk With 10" End Panel on Left, Full Modesty and Full Gable on Right**

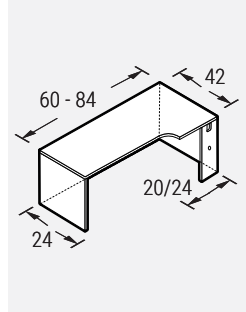

PRODUCT CODE	FINISH LP	B	W	SIZE/INCHES				WEIGHT LBS	VOL FT <sup>3</sup>
				H(LP/B)	H(W)	W	D		
<b>For 20" Return Connection</b>									
L2EC24604220L	1354	1686	1918	29	29.5	60	42	187	8
L2EC24664220L	1425	1783	2034	29	29.5	66	42	209	9
L2EC24724220L	1491	1882	2150	29	29.5	72	42	231	10
L2EC24784220L	1561	1981	2266	29	29.5	78	42	253	11
L2EC24844220L	1630	2079	2386	29	29.5	84	42	275	12
<b>For 24" Return Connection</b>									
L2EC24604224L	1354	1686	1918	29	29.5	60	42	187	8
L2EC24664224L	1425	1783	2034	29	29.5	66	42	209	9
L2EC24724224L	1491	1882	2150	29	29.5	72	42	231	10
L2EC24784224L	1561	1981	2266	29	29.5	78	42	253	11
L2EC24844224L	1630	2079	2386	29	29.5	84	42	275	12

**L2DEC-R • Extended Corner Desk With 10" End Panel on Left, Full Modesty and Full Gable Right**

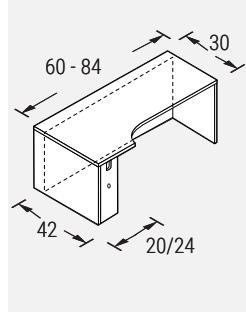

• All recessed modesties are inset 6" from the visitor edge.

PRODUCT CODE	FINISH LP	B	W	SIZE/INCHES				WEIGHT LBS	VOL FT <sup>3</sup>
				H(LP/B)	H(W)	W	D		
<b>For 20" Connection</b>									
L2DEC20426030R	1402	1738	1974	29	29.5	60	42	187	8
L2DEC20426630R	1474	1839	2094	29	29.5	66	42	209	9
L2DEC20427230R	1545	1938	2213	29	29.5	72	42	231	10
L2DEC20427830R	1612	2040	2330	29	29.5	78	42	253	11
L2DEC20428430R	1683	2138	2447	29	29.5	84	42	275	12
<b>For 24" Connection</b>									
L2DEC24426030R	1402	1738	1974	29	29.5	60	42	187	8
L2DEC24426630R	1474	1839	2094	29	29.5	66	42	209	9
L2DEC24427230R	1545	1938	2213	29	29.5	72	42	231	10
L2DEC24427830R	1612	2040	2330	29	29.5	78	42	253	11
L2DEC24428430R	1683	2138	2447	29	29.5	84	42	275	12

**L2DEC-L • Extended Corner Desk With 10" End Panel on Right, Full Modesty and Full Gable Left**

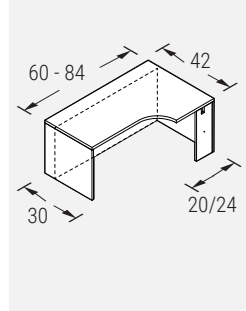

• All recessed modesties are inset 6" from the visitor edge.

PRODUCT CODE	FINISH LP	B	W	SIZE/INCHES				WEIGHT LBS	VOL FT <sup>3</sup>
				H(LP/B)	H(W)	W	D		
<b>For 20" Connection</b>									
L2DEC30604220L	1402	1738	1974	29	29.5	60	42	187	8
L2DEC30664220L	1474	1839	2094	29	29.5	66	42	209	9
L2DEC30724220L	1545	1938	2213	29	29.5	72	42	231	10
L2DEC30784220L	1612	2040	2330	29	29.5	78	42	253	11
L2DEC30844220L	1683	2138	2447	29	29.5	84	42	275	12
<b>For 24" Connection</b>									
L2DEC30604224L	1402	1738	1974	29	29.5	60	42	187	8
L2DEC30664224L	1474	1839	2094	29	29.5	66	42	209	9
L2DEC30724224L	1545	1938	2213	29	29.5	72	42	231	10
L2DEC30784224L	1612	2040	2330	29	29.5	78	42	253	11
L2DEC30844224L	1683	2138	2447	29	29.5	84	42	275	12

**L2DEC-R • Extended Corner Desk With 10" End Panel on Left, Full Modesty and Full Gable Right**

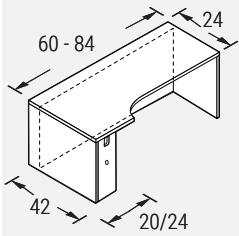

• All recessed modesties are inset 6" from the visitor edge.

PRODUCT CODE	FINISH			SIZE/INCHES				WEIGHT LBS	VOL FT <sup>3</sup>
	LP	B	W	H(LP/B)	H(W)	W	D		
<b>For 20" Connection</b>									
L2DEC20426024R	1377	1710	1944	29	29.5	60	42	187	8
L2DEC20426624R	1443	1810	2063	29	29.5	66	42	209	9
L2DEC20427224R	1513	1909	2182	29	29.5	72	42	231	10
L2DEC20427824R	1586	2011	2301	29	29.5	78	42	253	11
L2DEC20428424R	1652	2110	2420	29	29.5	84	42	275	12
<b>For 24" Connection</b>									
L2DEC24426024R	1377	1710	1944	29	29.5	60	42	187	8
L2DEC24426624R	1443	1810	2063	29	29.5	66	42	209	9
L2DEC24427224R	1513	1909	2182	29	29.5	72	42	231	10
L2DEC24427824R	1586	2011	2301	29	29.5	78	42	253	11
L2DEC24428424R	1652	2110	2420	29	29.5	84	42	275	12

**L2DEC-L • Extended Corner Desk With 10" End Panel on Right, Full Modesty and Full Gable Left**

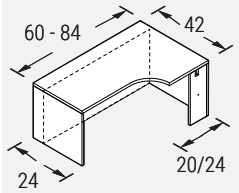

• All recessed modesties are inset 6" from the visitor edge.

PRODUCT CODE	FINISH			SIZE/INCHES				WEIGHT LBS	VOL FT <sup>3</sup>
	LP	B	W	H(LP/B)	H(W)	W	D		
<b>For 20" Connection</b>									
L2DEC24604220L	1377	1710	1944	29	29.5	60	42	187	8
L2DEC24664220L	1443	1810	2063	29	29.5	66	42	209	9
L2DEC24724220L	1513	1909	2182	29	29.5	72	42	231	10
L2DEC24784220L	1586	2011	2301	29	29.5	78	42	253	11
L2DEC24844220L	1652	2110	2420	29	29.5	84	42	275	12
<b>For 24" Connection</b>									
L2DEC24604224L	1377	1710	1944	29	29.5	60	42	187	8
L2DEC24664224L	1443	1810	2063	29	29.5	66	42	209	9
L2DEC24724224L	1513	1909	2182	29	29.5	72	42	231	10
L2DEC24784224L	1586	2011	2301	29	29.5	78	42	253	11
L2DEC24844224L	1652	2110	2420	29	29.5	84	42	275	12

**L2CS • Corner With Straight Front, Full Back Panel and Narrow End Gables**

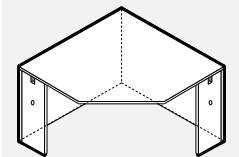

• For grain direction on surfaces larger than 42", please see grain direction chart at beginning of the Price List

PRODUCT CODE	FINISH			SIZE/INCHES				WEIGHT LBS	VOL FT <sup>3</sup>
	LP	B	W	H(LP/B)	H(W)	W	D		
L2CS183618	1107	1367	1707	29	29.5	36	36	79	3
L2CS183620	1135	1398	1752	29	29.5	36	36	84	3
L2CS183624	1135	1398	1752	29	29.5	36	36	84	3
L2CS203618	1135	1398	1752	29	29.5	36	36	84	3
L2CS203620	1181	1475	1899	29	29.5	36	36	88	3
L2CS203624	1210	1509	1942	29	29.5	36	36	88	3
L2CS243618	1135	1398	1752	29	29.5	36	36	84	3
L2CS243620	1210	1509	1942	29	29.5	36	36	88	3
L2CS243624	1210	1509	1942	29	29.5	36	36	88	3
L2CS184218	1214	1501	1863	29	29.5	42	42	87	4
L2CS184220	1247	1537	1910	29	29.5	42	42	92	4
L2CS184224	1247	1537	1910	29	29.5	42	42	92	4
L2CS204218	1247	1537	1910	29	29.5	42	42	92	4
L2CS204220	1247	1537	1910	29	29.5	42	42	97	4
L2CS204224	1275	1575	2017	29	29.5	42	42	97	4
L2CS244218	1247	1537	1910	29	29.5	42	42	92	4
L2CS244220	1275	1575	2017	29	29.5	42	42	97	4
L2CS244224	1275	1575	2017	29	29.5	42	42	97	4
L2CS184818	1286	1572	1936	29	29.5	48	48	97	6
L2CS184820	1317	1610	1984	29	29.5	48	48	101	6
L2CS184824	1317	1610	1984	29	29.5	48	48	101	6
L2CS204818	1317	1610	1984	29	29.5	48	48	101	6
L2CS204820	1317	1610	1984	29	29.5	48	48	107	6
L2CS204824	1349	1648	2089	29	29.5	48	48	107	6
L2CS244818	1317	1610	1984	29	29.5	48	48	101	6
L2CS244820	1349	1648	2089	29	29.5	48	48	107	6
L2CS244824	1349	1648	2089	29	29.5	48	48	107	6

**L2CSH • Corner With Straight Front, Cut-Out Back Panel and Narrow End Gables**

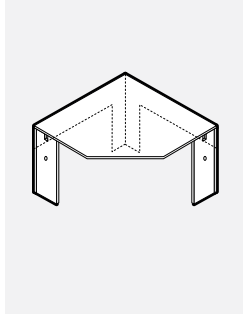

• For grain direction on surfaces larger than 42", please see grain direction chart at beginning of the Price List

PRODUCT CODE	FINISH LP	B	W	SIZE / INCHES			D	WEIGHT LBS	VOL FT <sup>3</sup>
				H (LP/B)	H (W)	W			
L2CSH183618	1143	1403	1744	29	29.5	36	36	51	3
L2CSH183620	1176	1437	1790	29	29.5	36	36	55	3
L2CSH183624	1176	1437	1790	29	29.5	36	36	55	3
L2CSH203618	1176	1437	1790	29	29.5	36	36	55	3
L2CSH203620	1221	1512	1938	29	29.5	36	36	59	3
L2CSH203624	1248	1549	1981	29	29.5	36	36	59	3
L2CSH243618	1176	1437	1790	29	29.5	36	36	55	3
L2CSH243620	1248	1549	1981	29	29.5	36	36	59	3
L2CSH243624	1248	1549	1981	29	29.5	36	36	59	3
L2CSH184218	1257	1545	1906	29	29.5	42	42	57	4
L2CSH184220	1290	1582	1957	29	29.5	42	42	63	4
L2CSH184224	1290	1582	1957	29	29.5	42	42	63	4
L2CSH204218	1290	1582	1957	29	29.5	42	42	63	4
L2CSH204220	1290	1582	1957	29	29.5	42	42	68	4
L2CSH204224	1319	1619	2063	29	29.5	42	42	68	4
L2CSH244218	1290	1582	1957	29	29.5	42	42	63	4
L2CSH244220	1319	1619	2063	29	29.5	42	42	68	4
L2CSH244224	1319	1619	2063	29	29.5	42	42	68	4
L2CSH184818	1348	1641	2009	29	29.5	48	48	65	6
L2CSH184820	1382	1678	2058	29	29.5	48	48	70	6
L2CSH184824	1382	1678	2058	29	29.5	48	48	70	6
L2CSH204818	1382	1678	2058	29	29.5	48	48	70	6
L2CSH204820	1382	1678	2058	29	29.5	48	48	76	6
L2CSH204824	1414	1718	2166	29	29.5	48	48	76	6
L2CSH244818	1382	1678	2058	29	29.5	48	48	70	6
L2CSH244820	1414	1718	2166	29	29.5	48	48	76	6
L2CSH244824	1414	1718	2166	29	29.5	48	48	76	6

**L2CC • Corner With Curved Front, Full Back Panel and Narrow End Gables**

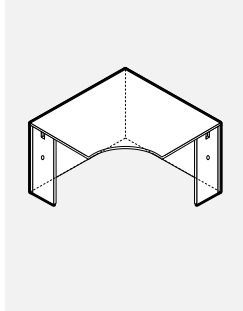

• For grain direction on surfaces larger than 42", please see grain direction chart at beginning of the Price List

PRODUCT CODE	FINISH LP	B	W	SIZE / INCHES			D	WEIGHT LBS	VOL FT <sup>3</sup>
				H (LP/B)	H (W)	W			
L2CC183618	1123	1388	1740	29	29.5	36	36	79	3
L2CC183620	1153	1425	1785	29	29.5	36	36	84	3
L2CC183624	1153	1425	1785	29	29.5	36	36	84	3
L2CC203618	1153	1425	1785	29	29.5	36	36	84	3
L2CC203620	1199	1504	1938	29	29.5	36	36	88	3
L2CC203624	1226	1536	1981	29	29.5	36	36	88	3
L2CC243618	1153	1425	1785	29	29.5	36	36	84	3
L2CC243620	1226	1536	1981	29	29.5	36	36	88	3
L2CC243624	1226	1536	1981	29	29.5	36	36	88	3
L2CC184218	1230	1526	1901	29	29.5	42	42	87	4
L2CC184220	1263	1565	1950	29	29.5	42	42	92	4
L2CC184224	1263	1565	1950	29	29.5	42	42	92	4
L2CC204218	1263	1565	1950	29	29.5	42	42	92	4
L2CC204220	1263	1565	1950	29	29.5	42	42	97	4
L2CC204224	1296	1604	2058	29	29.5	42	42	97	4
L2CC244218	1263	1565	1950	29	29.5	42	42	92	4
L2CC244220	1296	1604	2058	29	29.5	42	42	97	4
L2CC244224	1296	1604	2058	29	29.5	42	42	97	4
L2CC184818	1321	1620	2003	29	29.5	48	48	97	6
L2CC184820	1353	1661	2052	29	29.5	48	48	101	6
L2CC184824	1353	1661	2052	29	29.5	48	48	101	6
L2CC204818	1353	1661	2052	29	29.5	48	48	101	6
L2CC204820	1388	1700	2160	29	29.5	48	48	107	6
L2CC204824	1388	1700	2160	29	29.5	48	48	107	6
L2CC244818	1353	1661	2052	29	29.5	48	48	101	6
L2CC244820	1388	1700	2160	29	29.5	48	48	107	6
L2CC244824	1388	1700	2160	29	29.5	48	48	107	6

**L2CCH • Corner With Curved Front, Cut-Out Back Panel and Narrow End Gables**

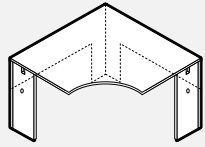

• For grain direction on surfaces larger than 42", please see grain direction chart at beginning of the Price List

PRODUCT CODE	FINISH			SIZE / INCHES				WEIGHT		VOL FT <sup>3</sup>
	LP	B	W	H (LP/B)	H (W)	W	D	LBS		
L2CCH183618	1161	1426	1903	29	29.5	36	36	51	3	
L2CCH183620	1191	1463	1909	29	29.5	36	36	55	3	
L2CCH183624	1191	1463	1909	29	29.5	36	36	55	3	
L2CCH203618	1191	1463	1909	29	29.5	36	36	55	3	
L2CCH203620	1237	1540	2067	29	29.5	36	36	59	3	
L2CCH203624	1267	1575	2067	29	29.5	36	36	59	3	
L2CCH243618	1191	1463	1909	29	29.5	36	36	55	3	
L2CCH243620	1267	1575	2067	29	29.5	36	36	59	3	
L2CCH243624	1267	1575	2067	29	29.5	36	36	59	3	
L2CCH184218	1274	1569	1943	29	29.5	42	42	57	4	
L2CCH184220	1308	1608	1993	29	29.5	42	42	63	4	
L2CCH184224	1308	1608	1993	29	29.5	42	42	63	4	
L2CCH204218	1308	1608	1993	29	29.5	42	42	63	4	
L2CCH204220	1308	1608	1993	29	29.5	42	42	68	4	
L2CCH204224	1339	1648	2100	29	29.5	42	42	68	4	
L2CCH244218	1308	1608	1993	29	29.5	42	42	63	4	
L2CCH244220	1339	1648	2100	29	29.5	42	42	68	4	
L2CCH244224	1339	1648	2100	29	29.5	42	42	68	4	
L2CCH184818	1375	1666	2046	29	29.5	48	48	65	6	
L2CCH184820	1399	1705	2096	29	29.5	48	48	70	6	
L2CCH184824	1399	1705	2096	29	29.5	48	48	70	6	
L2CCH204818	1399	1705	2096	29	29.5	48	48	70	6	
L2CCH204820	1399	1705	2096	29	29.5	48	48	76	6	
L2CCH204824	1432	1745	2204	29	29.5	48	48	76	6	
L2CCH244818	1399	1705	2096	29	29.5	48	48	70	6	
L2CCH244820	1432	1745	2204	29	29.5	48	48	76	6	
L2CCH244824	1432	1745	2204	29	29.5	48	48	76	6	

**L2CK • Split Corner Desk With Curved Front Keyboard, Full Back Panel and Narrow End Gables**

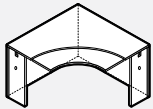

• For grain direction on surfaces larger than 42", please see grain direction chart at beginning of the Price List

PRODUCT CODE	FINISH			SIZE / INCHES				WEIGHT		VOL FT <sup>3</sup>
	LP	B	W	H (LP/B)	H (W)	W	D	LBS		
L2CK244224	2203	2586	3067	29	29.5	42	42	97	4	
L2CK244824	2309	2698	3186	29	29.5	48	48	107	6	

**L2CHK • Split Corner Desk With Curved Front Keyboard, Cut-Out Back Panel and Narrow End Gables**

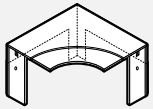

• For grain direction on surfaces larger than 42", please see grain direction chart at beginning of the Price List

PRODUCT CODE	FINISH			SIZE / INCHES				WEIGHT		VOL FT <sup>3</sup>
	LP	B	W	H (LP/B)	H (W)	W	D	LBS		
L2CHK244224	2246	2607	3089	29	29.5	42	42	68	4	
L2CHK244824	2353	2720	3207	29	29.5	48	48	76	6	



## TECHNICAL INFORMATION

- All Shaped tables are Shipped knocked down (KD).
- Monoleg or square leg ships in a separate box.
- All Units must be connected to an adjoining unit with flat brackets.
- For 24" deep returns that connect to an adjoining unit with included flat brackets.
- For 24" deep returns that connect to the corner units, the narrow panel is 10" and for 30" deep returns, the narrow panel is 14".
- All bottom edges are edge banded.
- Monolegs are drilled to accept shoulder screws to attach to the modesty.
- Modesty are offered 10" high only.
- Top plate with cut-out for 3" monoleg will accept modesty panel 1" thick.
- 8 x 8" plate is attached to surface with #10 3/4 wood screws, included.
- 1" height adjustment range.

## TABLES • GUIDELINES FOR ORDERING PRODUCT

**CODES:** The price list uses a numbering system with meaningful alphanumeric characters to create a simple-to-understand product number. This makes specifying the product much easier and more accurate.

### SPECIFICATION EXAMPLE OF A SHAPED TABLE

- PRODUCT CODE:** L2TDH3060  
 L2 = New Licence  
 T = Table  
 D = D Shape Worksurface  
 H = Half Modesty (10"High)  
 3060 = Size: Depth x Width
- OPTIONS:**
- Top: LP - LPL (Low Pressure Laminate) Thickness 1"  
 HP B - B Thickness 1 1/16"  
 HP W - W Thickness 1 7/16"
- Leg Option: L2BHML03 (DEFAULT) Round Monoleg  
 L2LSQ3X3 - Square Leg
- Top Finish Laminate: Choose Color
- Top PVC Edging: Choose Color
- Chassis Laminate: Choose Color
- Chassis PVC Edging: Choose Color
- Metal Leg Finish: Choose Color

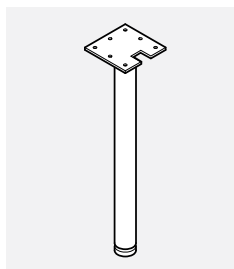

L2BHML03

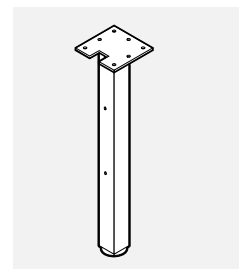

L2LSQ3X3

## L2TD • D-Shaped Top With T-Base and Leg

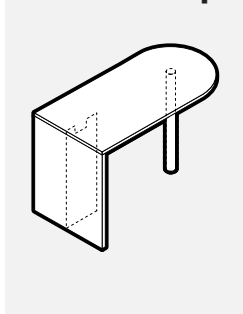

- Add \$103 to list price for chrome leg option.

PRODUCT CODE	FINISH LP	B	W	SIZE/INCHES			D	WEIGHT LBS	VOL FT <sup>3</sup>
				H (LP/B)	H (W)	W			
L2TD2442	973	1127	1237	29	29.5	42	24	64	3
L2TD2448	1002	1170	1294	29	29.5	48	24	68	3
L2TD2454	1030	1215	1350	29	29.5	54	24	72	3
L2TD2460	1057	1261	1408	29	29.5	60	24	76	4
L2TD2466	1086	1304	1466	29	29.5	66	24	79	4
L2TD2472	1113	1349	1524	29	29.5	72	24	84	4
L2TD2478	1142	1392	1578	29	29.5	78	24	87	6
L2TD2484	1170	1437	1637	29	29.5	84	24	91	6
L2TD3054	1119	1343	1504	29	29.5	54	30	97	4
L2TD3060	1153	1396	1570	29	29.5	60	30	107	7
L2TD3066	1187	1450	1641	29	29.5	66	30	117	8
L2TD3072	1221	1505	1707	29	29.5	72	30	127	9
L2TD3078	1256	1558	1776	29	29.5	78	30	136	9
L2TD3084	1289	1612	1846	29	29.5	84	30	146	10
L2TD3654	1203	1463	1645	29	29.5	54	36	107	4
L2TD3660	1241	1528	1725	29	29.5	60	36	111	10
L2TD3666	1278	1592	1807	29	29.5	66	36	116	9
L2TD3672	1317	1653	1884	29	29.5	72	36	153	10
L2TD3678	1356	1720	1965	29	29.5	78	36	165	11
L2TD3684	1394	1780	2042	29	29.5	84	36	176	12

**L2TDH • D-Shaped Top With Half Modesty and Leg**

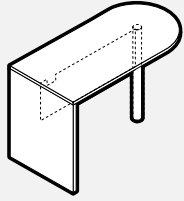

• Add \$103 to list price for chrome leg option.

PRODUCT CODE	FINISH			SIZE / INCHES				WEIGHT LBS	VOL FT <sup>3</sup>
	LP	B	W	H (LP/B)	H (W)	W	D		
L2TDH2442	954	1105	1218	29	29.5	42	24	63	3
L2TDH2448	995	1164	1286	29	29.5	48	24	69	3
L2TDH2454	1035	1219	1354	29	29.5	54	24	75	3
L2TDH2460	1073	1275	1426	29	29.5	60	24	81	4
L2TDH2466	1115	1334	1494	29	29.5	66	24	87	4
L2TDH2472	1155	1391	1565	29	29.5	72	24	94	4
L2TDH2478	1192	1446	1636	29	29.5	78	24	99	6
L2TDH2484	1232	1505	1702	29	29.5	84	24	106	6
L2TDH3054	1122	1343	1504	29	29.5	54	30	95	4
L2TDH3060	1166	1408	1583	29	29.5	60	30	102	7
L2TDH3066	1211	1478	1663	29	29.5	66	30	112	8
L2TDH3072	1257	1545	1744	29	29.5	72	30	122	9
L2TDH3078	1301	1610	1825	29	29.5	78	30	132	9
L2TDH3084	1346	1677	1909	29	29.5	84	30	142	10
L2TDH3654	1203	1466	1646	29	29.5	54	36	145	4
L2TDH3660	1256	1540	1737	29	29.5	60	36	151	10
L2TDH3666	1292	1604	1818	29	29.5	66	36	154	9
L2TDH3672	1343	1679	1909	29	29.5	72	36	156	10
L2TDH3678	1392	1755	2003	29	29.5	78	36	161	11
L2TDH3684	1445	1830	2095	29	29.5	84	36	172	12

**L2TR • Rectangular Top With T-Base and Mono Leg**

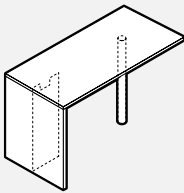

• Add \$103 to list price for chrome leg option.

PRODUCT CODE	FINISH			SIZE / INCHES				WEIGHT LBS	VOL FT <sup>3</sup>
	LP	B	W	H (LP/B)	H (W)	W	D		
L2TR2442	1040	1199	1317	29	29.5	42	24	64	3
L2TR2448	1065	1246	1378	29	29.5	48	24	68	3
L2TR2454	1097	1294	1440	29	29.5	54	24	72	3
L2TR2460	1128	1342	1502	29	29.5	60	24	76	4
L2TR2466	1157	1388	1560	29	29.5	66	24	79	4
L2TR2472	1184	1437	1624	29	29.5	72	24	84	4
L2TR2478	1218	1484	1683	29	29.5	78	24	87	6
L2TR2484	1246	1532	1745	29	29.5	84	24	91	6
L2TR3054	1191	1430	1601	29	29.5	54	30	97	4
L2TR3060	1227	1488	1674	29	29.5	60	30	107	7
L2TR3066	1265	1547	1748	29	29.5	66	30	112	8
L2TR3072	1300	1602	1818	29	29.5	72	30	127	9
L2TR3078	1337	1661	1893	29	29.5	78	30	136	9
L2TR3084	1373	1718	1966	29	29.5	84	30	146	10
L2TR3654	1279	1558	1753	29	29.5	54	36	107	4
L2TR3660	1321	1630	1837	29	29.5	60	36	111	7
L2TR3666	1361	1694	1925	29	29.5	66	36	116	8
L2TR3672	1403	1763	2007	29	29.5	72	36	153	9
L2TR3678	1445	1829	2093	29	29.5	78	36	165	9
L2TR3684	1485	1898	2177	29	29.5	84	36	176	10

**L2TRH • Rectangular Top With Half Modesty and Mono Leg**

• Add \$103 to list price for chrome leg option.

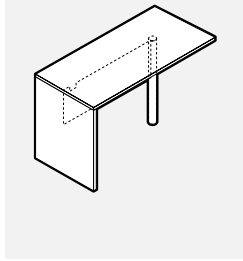

PRODUCT CODE	FINISH LP	B	W	SIZE/INCHES				D	WEIGHT LBS	VOL FT <sup>3</sup>
				H(LP/B)	H(W)	W	D			
L2TRH2442	1015	1177	1296	29	29.5	42	24	63	3	
L2TRH2448	1059	1237	1382	29	29.5	48	24	69	3	
L2TRH2454	1101	1297	1443	29	29.5	54	24	75	3	
L2TRH2460	1143	1359	1517	29	29.5	60	24	81	4	
L2TRH2466	1187	1421	1593	29	29.5	66	24	87	4	
L2TRH2472	1229	1482	1668	29	29.5	72	24	94	4	
L2TRH2478	1272	1543	1740	29	29.5	78	24	99	6	
L2TRH2484	1313	1602	1814	29	29.5	84	24	100	6	
L2TRH3054	1192	1430	1601	29	29.5	54	30	95	4	
L2TRH3060	1241	1502	1686	29	29.5	60	30	102	7	
L2TRH3066	1290	1572	1772	29	29.5	66	30	112	8	
L2TRH3072	1338	1645	1858	29	29.5	72	30	132	9	
L2TRH3078	1386	1717	1944	29	29.5	78	30	142	9	
L2TRH3084	1436	1783	2033	29	29.5	84	30	145	10	
L2TRH3654	1279	1560	1754	29	29.5	54	36	145	4	
L2TRH3660	1337	1641	1851	29	29.5	60	36	151	7	
L2TRH3666	1377	1710	1937	29	29.5	66	36	154	8	
L2TRH3672	1430	1790	2033	29	29.5	72	36	156	9	
L2TRH3678	1484	1868	2133	29	29.5	78	36	161	9	
L2TRH3684	1540	1950	2233	29	29.5	84	36	172	10	

**L2TA • Axe-Shaped Top With T-Base and Leg**

• Add \$103 to list price for chrome leg option.

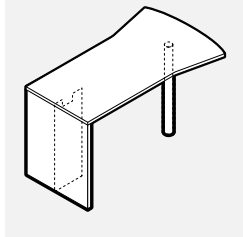

PRODUCT CODE	FINISH LP	B	W	SIZE/INCHES				D	WEIGHT LBS	VOL FT <sup>3</sup>
				H(LP/B)	H(W)	W	D			
L2TA3060	1278	1605	1829	29	29.50	60	42	131	10	
L2TA3066	1324	1679	1923	29	29.50	66	42	140	11	
L2TA3072	1369	1752	2014	29	29.50	72	42	149	12	
L2TA3078	1413	1823	2104	29	29.50	78	42	157	12	
L2TA3084	1456	1898	2200	29	29.50	84	42	166	13	
L2TA3672	1466	1900	2188	29	29.50	72	48	153	13	
L2TA3678	1515	1982	2294	29	29.50	78	48	163	14	
L2TA3684	1564	2066	2396	29	29.50	84	48	173	15	

**L2TAH • Axe-Shaped Top With Half Modesty and Leg**

• Add \$103 to list price for chrome leg option.

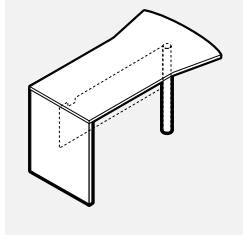

PRODUCT CODE	FINISH LP	B	W	SIZE/INCHES				D	WEIGHT LBS	VOL FT <sup>3</sup>
				H(LP/B)	H(W)	W	D			
L2TAH3060	1292	1618	1846	29	29.50	60	42	127	10	
L2TAH3066	1346	1702	1947	29	29.50	66	42	135	11	
L2TAH3072	1403	1788	2051	29	29.50	72	42	144	12	
L2TAH3078	1459	1877	2155	29	29.50	78	42	153	12	
L2TAH3084	1515	1961	2258	29	29.50	84	42	162	13	
L2TAH3672	1490	1926	2217	29	29.50	72	48	149	13	
L2TAH3678	1553	2022	2332	29	29.50	78	48	158	14	
L2TAH3684	1612	2117	2445	29	29.50	84	48	168	15	

**L2TP-L • P-Shaped Top Left With T-Base and Leg**

• Add \$103 to list price for chrome leg option.

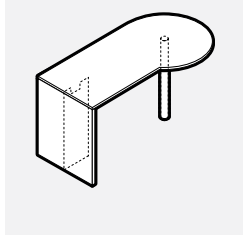

PRODUCT CODE	FINISH LP	B	W	SIZE/INCHES				D	WEIGHT LBS	VOL FT <sup>3</sup>
				H(LP/B)	H(W)	W	D			
L2TP3060L	1219	1505	1707	29	29.50	60	36	121	9	
L2TP3066L	1259	1569	1785	29	29.50	66	36	135	9	
L2TP3072L	1297	1632	1867	29	29.50	72	36	150	10	
L2TP3078L	1335	1695	1945	29	29.50	78	36	164	11	
L2TP3084L	1376	1761	2026	29	29.50	84	36	178	12	
L2TP3672L	1394	1780	2042	29	29.50	72	42	188	12	
L2TP3678L	1441	1853	2134	29	29.50	78	42	202	12	
L2TP3684L	1484	1927	2225	29	29.50	84	42	217	13	

**L2TP-R • P-Shaped Top Right With T-Base and Leg**

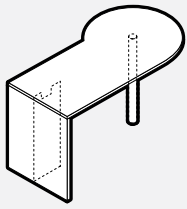

• Add \$103 to list price for chrome leg option.

PRODUCT CODE	FINISH LP	B	W	SIZE / INCHES				WEIGHT LBS	VOL FT <sup>3</sup>
				H (LP/B)	H (W)	W	D		
L2TP3060R	1219	1505	1707	29	29.50	60	36	121	9
L2TP3066R	1259	1569	1785	29	29.50	66	36	135	9
L2TP3072R	1297	1632	1867	29	29.50	72	36	150	10
L2TP3078R	1335	1695	1945	29	29.50	78	36	164	11
L2TP3084R	1376	1761	2026	29	29.50	84	36	178	12
L2TP3672R	1394	1780	2042	29	29.50	72	42	188	12
L2TP3678R	1441	1853	2134	29	29.50	78	42	202	12
L2TP3684R	1484	1927	2225	29	29.50	84	42	217	13

**L2TPH-L • P-Shaped Top Left With Half Modesty and Leg**

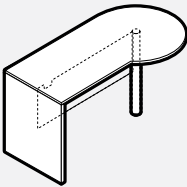

• Add \$103 to list price for chrome leg option.

PRODUCT CODE	FINISH LP	B	W	SIZE / INCHES				WEIGHT LBS	VOL FT <sup>3</sup>
				H (LP/B)	H (W)	W	D		
L2TPH3060L	1230	1516	1720	29	29.50	60	36	117	9
L2TPH3066L	1279	1592	1812	29	29.50	66	36	131	9
L2TPH3072L	1334	1668	1903	29	29.50	72	36	145	10
L2TPH3078L	1383	1744	1996	29	29.50	78	36	160	11
L2TPH3084L	1434	1819	2089	29	29.50	84	36	174	12
L2TPH3672L	1419	1807	2067	29	29.50	72	42	184	12
L2TPH3678L	1474	1890	2173	29	29.50	78	42	198	12
L2TPH3684L	1529	1976	2276	29	29.50	84	42	212	13

**L2TPH-R • P-Shaped Top Right With Half Modesty and Leg**

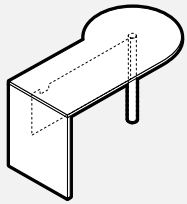

• Add \$103 to list price for chrome leg option.

PRODUCT CODE	FINISH LP	B	W	SIZE / INCHES				WEIGHT LBS	VOL FT <sup>3</sup>
				H (LP/B)	H (W)	W	D		
L2TPH3060R	1230	1516	1720	29	29.50	60	36	117	9
L2TPH3066R	1279	1592	1812	29	29.50	66	36	131	9
L2TPH3072R	1334	1668	1903	29	29.50	72	36	145	10
L2TPH3078R	1383	1744	1996	29	29.50	78	36	160	11
L2TPH3084R	1434	1819	2089	29	29.50	84	36	174	12
L2TPH3672R	1419	1807	2067	29	29.50	72	42	184	12
L2TPH3678R	1474	1890	2173	29	29.50	78	42	198	12
L2TPH3684R	1529	1976	2276	29	29.50	84	42	212	13

**L2TH-L • Hockey-Shaped Top Left With T-Base and Leg**

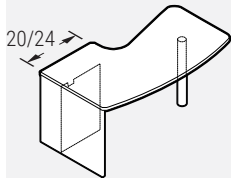

• Add \$103 to list price for chrome leg option.

PRODUCT CODE	FINISH LP	B	W	SIZE / INCHES				WEIGHT LBS	VOL FT <sup>3</sup>
				H (LP/B)	H (W)	W	D		
<b>For 20" Return Connection</b>									
L2TH203060L	1268	1561	1781	29	29.50	60	36	121	9
L2TH203066L	1308	1624	1863	29	29.50	66	36	135	9
L2TH203072L	1346	1690	1943	29	29.50	72	36	150	10
L2TH203078L	1387	1753	2026	29	29.50	78	36	164	11
L2TH203084L	1426	1819	2107	29	29.50	84	36	178	12
L2TH203660L	1356	1694	1939	29	29.50	60	42	188	10
L2TH203666L	1403	1769	2034	29	29.50	66	42	202	11
L2TH203672L	1448	1844	2126	29	29.50	72	42	217	12
L2TH203678L	1494	1918	2220	29	29.50	78	42	220	12
L2TH203684L	1537	1991	2312	29	29.50	84	42	237	13
<b>For 24" Return Connection</b>									
L2TH3060L	1268	1561	1781	29	29.50	60	36	121	9
L2TH3066L	1308	1624	1863	29	29.50	66	36	135	9
L2TH3072L	1346	1690	1943	29	29.50	72	36	150	10
L2TH3078L	1387	1753	2026	29	29.50	78	36	164	11
L2TH3084L	1426	1819	2107	29	29.50	84	36	178	12
L2TH3660L	1356	1694	1939	29	29.50	60	42	188	10
L2TH3666L	1403	1769	2034	29	29.50	66	42	202	11
L2TH3672L	1448	1844	2126	29	29.50	72	42	217	12
L2TH3678L	1494	1918	2220	29	29.50	78	42	220	12
L2TH3684L	1537	1991	2312	29	29.50	84	42	237	13

**L2TH-R • Hockey-Shaped Top Right With T-Base and Leg**

• Add \$103 to list price for chrome leg option.

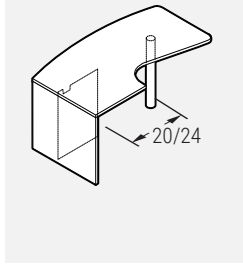

PRODUCT CODE	FINISH LP	B	W	SIZE/INCHES				WEIGHT LBS	VOL FT <sup>3</sup>
				H(LP/B)	H(W)	W	D		
<b>For 20" Return Connection</b>									
L2TH203060R	1268	1561	1781	29	29.50	60	36	121	9
L2TH203066R	1308	1624	1863	29	29.50	66	36	135	9
L2TH203072R	1346	1690	1943	29	29.50	72	36	150	10
L2TH203078R	1387	1753	2026	29	29.50	78	36	164	11
L2TH203084R	1426	1819	2107	29	29.50	84	36	178	12
L2TH203660R	1356	1694	1939	29	29.50	60	42	188	10
L2TH203666R	1403	1769	2034	29	29.50	66	42	202	11
L2TH203672R	1448	1844	2126	29	29.50	72	42	217	12
L2TH203678R	1494	1918	2220	29	29.50	78	42	220	12
L2TH203684R	1537	1991	2312	29	29.50	84	42	237	13
<b>For 24" Return Connection</b>									
L2TH3060R	1268	1561	1781	29	29.50	60	36	121	9
L2TH3066R	1308	1624	1863	29	29.50	66	36	135	9
L2TH3072R	1346	1690	1943	29	29.50	72	36	150	10
L2TH3078R	1387	1753	2026	29	29.50	78	36	164	11
L2TH3084R	1426	1819	2107	29	29.50	84	36	178	12
L2TH3660R	1356	1694	1939	29	29.50	60	42	188	10
L2TH3666R	1403	1769	2034	29	29.50	66	42	202	11
L2TH3672R	1448	1844	2126	29	29.50	72	42	217	12
L2TH3678R	1494	1918	2220	29	29.50	78	42	220	12
L2TH3684R	1537	1991	2312	29	29.50	84	42	237	13

**L2THH-L • Hockey-Shaped Top Left With Half Modesty and Leg**

• Add \$103 to list price for chrome leg option.

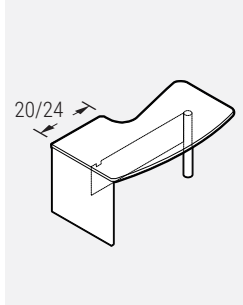

PRODUCT CODE	FINISH LP	B	W	SIZE/INCHES				WEIGHT LBS	VOL FT <sup>3</sup>
				H(LP/B)	H(W)	W	D		
<b>For 20" Return Connection</b>									
L2THH203060L	1279	1572	1794	29	29.50	60	36	117	9
L2THH203066L	1334	1650	1890	29	29.50	66	36	131	9
L2THH203072L	1385	1728	1984	29	29.50	72	36	145	10
L2THH203078L	1436	1807	2079	29	29.50	78	36	160	11
L2THH203084L	1488	1884	2173	29	29.50	84	36	174	12
L2THH203660L	1358	1694	1939	29	29.50	60	42	184	10
L2THH203666L	1418	1780	2046	29	29.50	66	42	198	11
L2THH203672L	1474	1867	2150	29	29.50	72	42	212	12
L2THH203678L	1532	1955	2258	29	29.50	78	42	220	12
L2THH203684L	1588	2042	2364	29	29.50	84	42	237	13
<b>For 24" Return Connection</b>									
L2THH3060L	1279	1572	1794	29	29.50	60	36	117	9
L2THH3066L	1334	1650	1890	29	29.50	66	36	131	9
L2THH3072L	1385	1728	1984	29	29.50	72	36	145	10
L2THH3078L	1436	1807	2079	29	29.50	78	36	160	11
L2THH3084L	1488	1884	2173	29	29.50	84	36	174	12
L2THH3660L	1358	1694	1939	29	29.50	60	42	184	10
L2THH3666L	1418	1780	2046	29	29.50	66	42	198	11
L2THH3672L	1474	1867	2150	29	29.50	72	42	212	12
L2THH3678L	1532	1955	2258	29	29.50	78	42	220	12
L2THH3684L	1588	2042	2364	29	29.50	84	42	237	13

**L2THH-R • Hockey-Shaped Top Right With Half Modesty and Leg**

• Add \$103 to list price for chrome leg option.

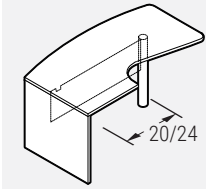

PRODUCT CODE	FINISH LP	B	W	SIZE / INCHES				WEIGHT LBS	VOL FT <sup>3</sup>
				H (LP/B)	H (W)	W	D		
<b>For 20" Return Connection</b>									
L2THH203060R	1279	1572	1794	29	29.50	60	36	117	9
L2THH203066R	1334	1650	1890	29	29.50	66	36	131	9
L2THH203072R	1385	1728	1984	29	29.50	72	36	145	10
L2THH203078R	1436	1807	2079	29	29.50	78	36	160	11
L2THH203084R	1488	1884	2173	29	29.50	84	36	174	12
L2THH203660R	1358	1694	1939	29	29.50	60	42	184	10
L2THH203666R	1418	1780	2046	29	29.50	66	42	198	11
L2THH203672R	1474	1867	2150	29	29.50	72	42	212	12
L2THH203678R	1532	1955	2258	29	29.50	78	42	220	12
L2THH203684R	1588	2042	2364	29	29.50	84	42	237	13
<b>For 24" Return Connection</b>									
L2THH3060R	1279	1572	1794	29	29.50	60	36	117	9
L2THH3066R	1334	1650	1890	29	29.50	66	36	131	9
L2THH3072R	1385	1728	1984	29	29.50	72	36	145	10
L2THH3078R	1436	1807	2079	29	29.50	78	36	160	11
L2THH3084R	1488	1884	2173	29	29.50	84	36	174	12
L2THH3660R	1358	1694	1939	29	29.50	60	42	184	10
L2THH3666R	1418	1780	2046	29	29.50	66	42	198	11
L2THH3672R	1474	1867	2150	29	29.50	72	42	212	12
L2THH3678R	1532	1955	2258	29	29.50	78	42	220	12
L2THH3684R	1588	2042	2364	29	29.50	84	42	237	13

**L2TEDH-L • Extended "D" With Half Modesty and Leg**

• Add \$103 to list price for chrome leg option.

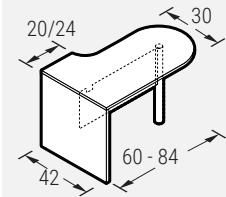

PRODUCT CODE	FINISH LP	B	W	SIZE / INCHES				WEIGHT LBS	VOL FT <sup>3</sup>
				H (LP/B)	H (W)	W	D		
<b>For 20" Return Connection</b>									
L2TEDH603020L	1388	1653	1894	29	29.50	60	42	110	8
L2TEDH663020L	1446	1737	1996	29	29.50	66	42	121	9
L2TEDH723020L	1505	1821	2099	29	29.50	72	42	132	10
L2TEDH783020L	1563	1906	2201	29	29.50	78	42	143	11
L2TEDH843020L	1618	1991	2304	29	29.50	84	42	154	12
<b>For 24" Return Connection</b>									
L2TEDH603024L	1388	1653	1894	29	29.50	60	42	110	8
L2TEDH663024L	1446	1737	1996	29	29.50	66	42	121	9
L2TEDH723024L	1505	1821	2099	29	29.50	72	42	132	10
L2TEDH783024L	1563	1906	2201	29	29.50	78	42	143	11
L2TEDH843024L	1618	1991	2304	29	29.50	84	42	154	12

**L2TED-L • Extended "D" With T-Base and Leg**

• Add \$103 to list price for chrome leg option.

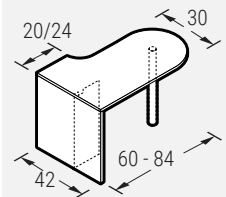

PRODUCT CODE	FINISH LP	B	W	SIZE / INCHES				WEIGHT LBS	VOL FT <sup>3</sup>
				H (LP/B)	H (W)	W	D		
<b>For 20" Return Connection</b>									
L2TED603020L	1376	1621	1860	29	29.50	60	42	110	8
L2TED663020L	1421	1694	1947	29	29.50	66	42	121	9
L2TED723020L	1466	1766	2039	29	29.50	72	42	132	10
L2TED783020L	1511	1836	2130	29	29.50	78	42	143	11
L2TED843020L	1556	1906	2218	29	29.50	84	42	154	12
<b>For 24" Return Connection</b>									
L2TED603024L	1376	1621	1860	29	29.50	60	42	110	8
L2TED663024L	1421	1694	1947	29	29.50	66	42	121	9
L2TED723024L	1466	1766	2039	29	29.50	72	42	132	10
L2TED783024L	1511	1836	2130	29	29.50	78	42	143	11
L2TED843024L	1556	1906	2218	29	29.50	84	42	154	12

**L2TEDH-R • Extended “D” With Half Modesty and Leg**

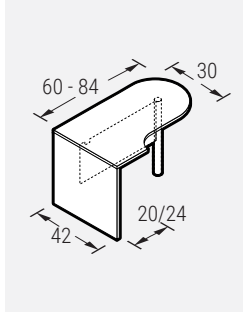

• Add \$103 to list price for chrome leg option.

PRODUCT CODE	FINISH LP	B	W	SIZE / INCHES			D	WEIGHT LBS	VOL FT <sup>3</sup>
				H (LP/B)	H (W)	W			
<b>For 20" Return Connection</b>									
L2TEDH603020R	1388	1653	1894	29	29.50	60	42	110	8
L2TEDH663020R	1446	1737	1996	29	29.50	66	42	121	9
L2TEDH723020R	1505	1821	2099	29	29.50	72	42	132	10
L2TEDH783020R	1563	1906	2201	29	29.50	78	42	143	11
L2TEDH843020R	1618	1991	2304	29	29.50	84	42	154	12
<b>For 24" Return Connection</b>									
L2TEDH603024R	1388	1653	1894	29	29.50	60	42	110	8
L2TEDH663024R	1446	1737	1996	29	29.50	66	42	121	9
L2TEDH723024R	1505	1821	2099	29	29.50	72	42	132	10
L2TEDH783024R	1563	1906	2201	29	29.50	78	42	143	11
L2TEDH843024R	1618	1991	2304	29	29.50	84	42	154	12

**L2TED-R • Extended “D” With T-Base and Leg**

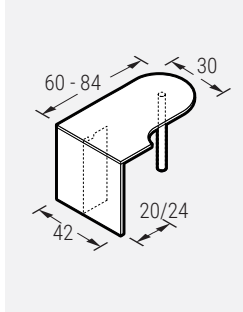

• Add \$103 to list price for chrome leg option.

PRODUCT CODE	FINISH LP	B	W	SIZE / INCHES			D	WEIGHT LBS	VOL FT <sup>3</sup>
				H (LP/B)	H (W)	W			
<b>For 20" Return Connection</b>									
L2TED603020R	1376	1621	1860	29	29.50	60	42	110	8
L2TED663020R	1421	1694	1947	29	29.50	66	42	121	9
L2TED723020R	1466	1766	2039	29	29.50	72	42	132	10
L2TED783020R	1511	1836	2130	29	29.50	78	42	143	11
L2TED843020R	1556	1906	2218	29	29.50	84	42	154	12
<b>For 24" Return Connection</b>									
L2TED603024R	1376	1621	1860	29	29.50	60	42	110	8
L2TED663024R	1421	1694	1947	29	29.50	66	42	121	9
L2TED723024R	1466	1766	2039	29	29.50	72	42	132	10
L2TED783024R	1511	1836	2130	29	29.50	78	42	143	11
L2TED843024R	1556	1906	2218	29	29.50	84	42	154	12

**L2TROL • Licence 2 Top With “O” Leg and T Base**

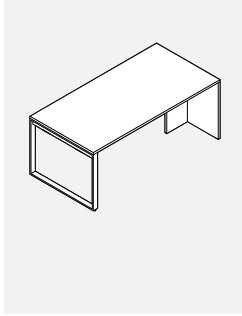

- Includes worksurface, loop leg and laminate T base.
- BG5 grommet please specify TC only.
- Loop leg is painted please specify standard paint color.

PRODUCT CODE	FINISH				W	WEIGHT		VOL FT <sup>3</sup>
	LP	B	W	D		LBS		
L2TROL2442	1128	1210	1322	24	42	138	5	
L2TROL2448	1177	1277	1380	24	48	153	5	
L2TROL2454	1230	1343	1436	24	54	168	6	
L2TROL2460	1273	1400	1494	24	60	183	6	
L2TROL2466	1291	1424	1549	24	66	198	6	
L2TROL2472	1308	1448	1609	24	72	213	7	
L2TROL2478	1340	1485	1661	24	78	228	7	
L2TROL2484	1378	1531	1716	24	84	243	7	
L2TROL3042	1322	1429	1524	30	42	168	7	
L2TROL3048	1340	1451	1539	30	48	187	7	
L2TROL3054	1372	1484	1661	30	54	206	8	
L2TROL3060	1400	1533	1729	30	60	225	8	
L2TROL3066	1415	1556	1799	30	66	243	8	
L2TROL3072	1442	1588	1866	30	72	262	9	
L2TROL3078	1472	1621	1933	30	78	281	9	
L2TROL3084	1526	1690	2003	30	84	300	10	
L2TROL3642	1451	1553	1716	36	42	200	7	
L2TROL3648	1505	1618	1801	36	48	222	8	
L2TROL3654	1556	1684	1885	36	54	245	8	
L2TROL3660	1610	1752	1972	36	60	267	9	
L2TROL3666	1663	1818	2057	36	66	290	9	
L2TROL3672	1716	1883	2142	36	72	312	10	
L2TROL3678	1767	1947	2228	36	78	335	10	
L2TROL3684	1821	2015	2312	36	84	357	11	

**L2TCROL • Licence 2 Return With “O” Leg**

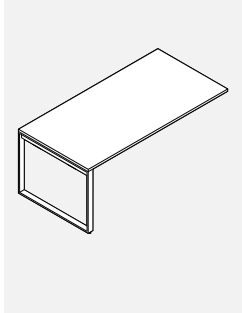

- Includes worksurface, loop leg and connecting brackets and connecting flat brackets
- HAT channel is standard on all tops except 42 and 48 wide
- BG5 grommet please specify TL,TC,TR
- Loop leg is painted please specify standard paint color
- Worksurface supporting pedestals and laterals will not fit due to the metal channel under the surface.

PRODUCT CODE	FINISH				W	WEIGHT		VOL FT <sup>3</sup>
	LP	B	W	D		LBS		
L2TCROL2442	901	988	1110	24	42	110	4	
L2TCROL2448	955	1060	1171	24	48	125	5	
L2TCROL2454	1095	1214	1315	24	54	140	5	
L2TCROL2460	1150	1288	1388	24	60	155	5	
L2TCROL2466	1181	1323	1458	24	66	170	6	
L2TCROL2472	1211	1361	1533	24	72	185	6	
L2TCROL2478	1257	1413	1599	24	78	200	6	
L2TCROL2484	1307	1473	1671	24	84	215	7	
L2TCROL3042	1076	1189	1292	30	42	137	6	
L2TCROL3048	1095	1214	1307	30	48	156	6	
L2TCROL3054	1213	1332	1521	30	54	175	7	
L2TCROL3060	1253	1396	1605	30	60	194	7	
L2TCROL3066	1279	1431	1691	30	66	212	8	
L2TCROL3072	1321	1477	1775	30	72	231	8	
L2TCROL3078	1362	1523	1857	30	78	250	8	
L2TCROL3084	1432	1609	1943	30	84	269	9	
L2TCROL3642	1214	1322	1497	36	42	164	7	
L2TCROL3648	1270	1392	1588	36	48	186	7	
L2TCROL3654	1409	1547	1763	36	54	209	8	
L2TCROL3660	1479	1629	1866	36	60	231	8	
L2TCROL3666	1548	1712	1969	36	66	254	9	
L2TCROL3672	1613	1792	2071	36	72	276	9	
L2TCROL3678	1679	1872	2173	36	78	299	10	
L2TCROL3684	1750	1955	2274	36	84	321	10	



**L2TDOL • Licence 2 Top With Two “O” Legs**

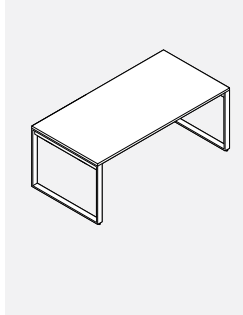

- Includes worksurface, 2 loop legs
- HAT channel is standard on all tops except 42 and 48 wide
- BG5 grommet please specify TL,TC,TR
- Loop leg is painted please specify standard paint color
- Worksurface supporting pedestals and laterals will not fit due to the metal channel under the surface.

PRODUCT CODE	FINISH					WEIGHT		VOL FT <sup>3</sup>
	LP	B	W	D	W	LBS		
L2TDOL2442	1434	1521	1642	24	42	115	6	
L2TDOL2448	1486	1593	1702	24	48	130	7	
L2TDOL2454	1628	1747	1847	24	54	145	7	
L2TDOL2460	1684	1820	1921	24	60	160	7	
L2TDOL2466	1715	1856	1991	24	66	175	8	
L2TDOL2472	1744	1894	2067	24	72	190	8	
L2TDOL2478	1788	1944	2133	24	78	205	8	
L2TDOL2484	1841	2006	2202	24	84	220	9	
L2TDOL3042	1691	1806	1907	30	42	143	9	
L2TDOL3048	1711	1830	1923	30	48	162	9	
L2TDOL3054	1828	1948	2138	30	54	181	10	
L2TDOL3060	1869	2012	2223	30	60	200	10	
L2TDOL3066	1896	2049	2308	30	66	218	11	
L2TDOL3072	1938	2094	2391	30	72	237	11	
L2TDOL3078	1979	2141	2474	30	78	256	11	
L2TDOL3084	2050	2225	2559	30	84	275	12	
L2TDOL3642	1893	2001	2176	36	42	170	10	
L2TDOL3648	1949	2071	2267	36	48	192	10	
L2TDOL3654	2089	2225	2441	36	54	215	11	
L2TDOL3660	2158	2308	2544	36	60	237	11	
L2TDOL3666	2227	2391	2648	36	66	260	12	
L2TDOL3672	2292	2471	2749	36	72	282	12	
L2TDOL3678	2358	2552	2851	36	78	305	13	
L2TDOL3684	2429	2635	2953	36	84	327	13	

**Technical Information**

All units must be connected to an adjoining unit with flat brackets included.  
 Grommet option for Runoff tables are "TC" only.  
 NOTE: All Runoff tables includes HAT CHANNEL support.

**OPTIONS:**

- Top: LP - LPL (Low Pressure Laminate) Thickness 1"  
 HP B - B Thickness 1 1/16"  
 HP W - W Thickness 1 7/16"
- Leg Option: BHML03 (DEFAULT) Round Monoleg  
 LLSQ3X3H28 - Square Leg
- Top Finish Laminate: Choose Color
- Top PVC Edging: Choose Color
- Metal Leg Finish: Choose Color

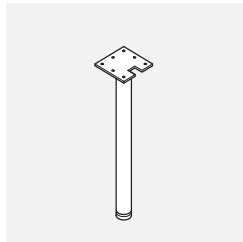

BHML03

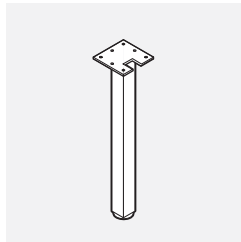

LLSQ3X3H28

**L2TCD • D-Shaped Runoff With Leg**



• Add \$103 to list price for chrome leg option.

PRODUCT CODE	FINISH			SIZE/INCHES				WEIGHT		VOL FT <sup>3</sup>
	LP	B	W	H (LP/B)	H (W)	W	D	LBS		
L2TCD3060	916	1151	1218	29	29.5	60	30	97	4	
L2TCD3066	972	1226	1310	29	29.5	66	30	106	6	
L2TCD3660	998	1272	1373	29	29.5	60	36	97	4	
L2TCD3666	1043	1343	1452	29	29.5	66	36	106	6	

**L2TCR1L • Rectangular-Shaped Runoff**

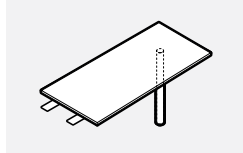

• Add \$103 to list price for chrome leg option.

PRODUCT CODE	FINISH			SIZE/INCHES				WEIGHT		VOL FT <sup>3</sup>
	LP	B	W	H (LP/B)	H (W)	W	D	LBS		
L2TCR1L3060	897	1123	1194	29	29.5	60	30	97	4	
L2TCR1L3066	937	1181	1261	29	29.5	66	30	106	6	
L2TCR1L3660	960	1225	1319	29	29.5	60	36	97	4	
L2TCR1L3666	1004	1294	1397	29	29.5	66	36	106	6	

**L2TCA1L • Axe-Shaped Runoff**

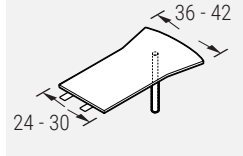

• Add \$103 to list price for chrome leg option.

PRODUCT CODE	FINISH			SIZE/INCHES				WEIGHT		VOL FT <sup>3</sup>
	LP	B	W	H (LP/B)	H (W)	W	D	LBS		
L2TCA1L2460	964	1229	1332	29	29.5	60	36	119	4	
L2TCA1L2466	1008	1297	1407	29	29.5	66	36	130	6	
L2TCA1L3060	1021	1328	1450	29	29.5	60	42	119	4	
L2TCA1L3066	1070	1403	1539	29	29.5	66	42	130	6	

**L2TCP • P-Shaped Runoff With Leg**

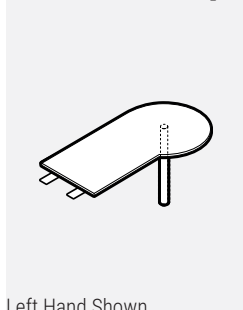

• Add \$103 to list price for chrome leg option.

PRODUCT CODE	FINISH			SIZE/INCHES				WEIGHT		VOL FT <sup>3</sup>
	LP	B	W	H (LP/B)	H (W)	W	D	LBS		
<b>Right</b>										
L2TCP3060R	995	1268	1373	29	29.5	60	36	119	4	
L2TCP3066R	1040	1342	1452	29	29.5	66	36	130	6	
L2TCP3660R	1059	1377	1504	29	29.5	60	42	119	4	
L2TCP3666R	1111	1456	1594	29	29.5	66	42	130	6	
<b>Left</b>										
L2TCP3060L	995	1268	1373	29	29.5	60	36	119	4	
L2TCP3066L	1040	1342	1452	29	29.5	66	36	130	6	
L2TCP3660L	1059	1377	1504	29	29.5	60	42	119	4	
L2TCP3666L	1111	1456	1594	29	29.5	66	42	130	6	

Left Hand Shown

**L2TCW • Wedge-Shaped Runoff With Leg**

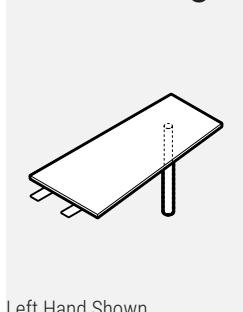

• Add \$103 to list price for chrome leg option.

PRODUCT CODE	FINISH			SIZE/INCHES				WEIGHT		VOL FT <sup>3</sup>
	LP	B	W	H (LP/B)	H (W)	W	D	LBS		
<b>Right</b>										
L2TCW3060R	941	1176	1261	29	29.5	60	30	119	4	
L2TCW3066R	982	1237	1331	29	29.5	66	30	130	6	
L2TCW3660R	1008	1284	1391	29	29.5	60	36	119	4	
L2TCW3666R	1053	1353	1470	29	29.5	66	36	130	6	
<b>Left</b>										
L2TCW3060L	941	1176	1261	29	29.5	60	30	119	4	
L2TCW3066L	982	1237	1331	29	29.5	66	30	130	6	
L2TCW3660L	1008	1284	1391	29	29.5	60	36	119	4	
L2TCW3666L	1053	1353	1470	29	29.5	66	36	130	6	

Left Hand Shown

**Floating Tops**

- Monolegs and Support channel ships in a separate box.
- Floating tops are not pre-drilled to accept monolegs or spacers.
- Grommet locations (TC only) must be specified at the time of order or it will default to "No Grommet" option.
- Floating top must be placed on top of 1H credenza or 1H lateral open.
- Grommet Option TC only
- All Floating tables include HAT CHANNEL support.

**LLSQ3X3 • "Spacer" Leg**

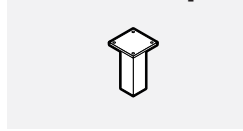

PRODUCT CODE	PRICE	CHROME OPT	SIZE/INCHES			WEIGHT LBS	VOL FT <sup>3</sup>
			H	W	D		
LLSQ3X3	183	285	8	3	3	4	0.09

**LLSQ3X3H28 • Square Leg**

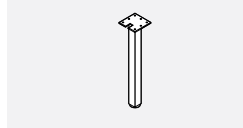

PRODUCT CODE	PRICE	CHROME OPT	SIZE/INCHES			WEIGHT LBS	VOL FT <sup>3</sup>
			H	W	D		
LLSQ3X3H28	328	428	28	3	3	4	0.17

**L2FD • Floating D-Shaped With Legs and Spacers**

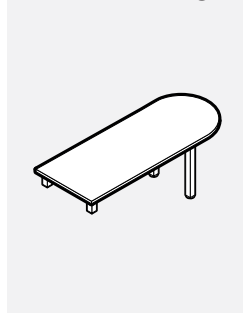

- Add \$415 to list price for chrome leg option.

PRODUCT CODE	FINISH			SIZE/INCHES				WEIGHT LBS	VOL FT <sup>3</sup>
	LP	B	W	H(LP/B)	H(W)	W	D		
L2FD3060	1208	1452	1478	29	29.5	60	30	53	7
L2FD3066	1248	1515	1545	29	29.5	66	30	57	7
L2FD3072	1289	1575	1610	29	29.5	72	30	62	8
L2FD3078	1334	1645	1677	29	29.5	78	30	64	8
L2FD3084	1388	1721	1740	29	29.5	84	30	68	9
L2FD3660	1267	1588	1705	29	29.5	60	36	57	8
L2FD3666	1312	1659	1788	29	29.5	66	36	63	8
L2FD3672	1356	1732	1868	29	29.5	72	36	68	9
L2FD3678	1408	1812	1952	29	29.5	78	36	70	9
L2FD3684	1470	1899	2035	29	29.5	84	36	75	10

**L2FR • Floating Rectangular-Shaped With Legs and Spacers**

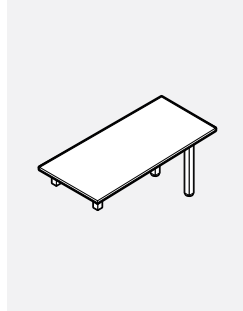

- Add \$415 to list price for chrome leg option.

PRODUCT CODE	FINISH			SIZE/INCHES				WEIGHT LBS	VOL FT <sup>3</sup>
	LP	B	W	H(LP/B)	H(W)	W	D		
L2FR2460	1142	1346	1383	29	29.5	60	24	51	6
L2FR2466	1177	1399	1437	29	29.5	66	24	55	6
L2FR2472	1215	1452	1494	29	29.5	72	24	59	7
L2FR2478	1256	1511	1550	29	29.5	78	24	62	7
L2FR2484	1304	1577	1607	29	29.5	84	24	66	8
L2FR3060	1203	1448	1507	29	29.5	60	30	53	7
L2FR3066	1245	1511	1572	29	29.5	66	30	57	7
L2FR3072	1286	1572	1642	29	29.5	72	30	62	8
L2FR3078	1332	1641	1707	29	29.5	78	30	64	8
L2FR3084	1385	1716	1774	29	29.5	84	30	68	9
L2FR3660	1226	1505	1617	29	29.5	60	36	57	8
L2FR3666	1270	1572	1694	29	29.5	66	36	63	8
L2FR3672	1315	1645	1772	29	29.5	72	36	68	9
L2FR3678	1364	1717	1851	29	29.5	78	36	70	9
L2FR3684	1424	1802	1930	29	29.5	84	36	75	10

**L2FA • Floating Axe-Shaped With Legs and Spacers**

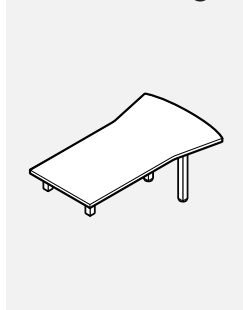

- Add \$415 to list price for chrome leg option.

PRODUCT CODE	FINISH			SIZE/INCHES				WEIGHT LBS	VOL FT <sup>3</sup>
	LP	B	W	H(LP/B)	H(W)	W	D		
L2FA3060	1334	1661	1770	29	29.5	60	42	77	8
L2FA3066	1385	1743	1860	29	29.5	66	42	81	8
L2FA3072	1436	1823	1950	29	29.5	72	42	84	9
L2FA3078	1491	1909	2039	29	29.5	78	42	88	9
L2FA3084	1558	2006	2130	29	29.5	84	42	95	10
L2FA3660	1421	1790	1936	29	29.5	60	48	83	9
L2FA3666	1475	1880	2038	29	29.5	66	48	88	9
L2FA3672	1533	1971	2138	29	29.5	72	48	90	10
L2FA3678	1594	2067	2239	29	29.5	78	48	95	11
L2FA3684	1666	2171	2341	29	29.5	84	48	101	11

**L2FP • Floating P-Shaped With Legs and Spacers**

• Add \$415 to list price for chrome leg option.

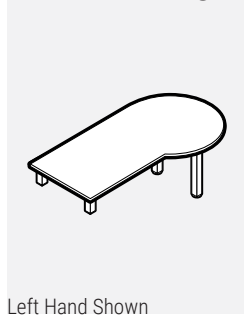

Left Hand Shown

PRODUCT CODE	FINISH LP	B	W	SIZE/INCHES			WEIGHT LBS	VOL FT <sup>3</sup>	
				H(LP/B)	H(W)	D			
<b>Right</b>									
L2FP3060R	1290	1577	1673	29	29.5	60	36	66	8
L2FP3066R	1335	1650	1752	29	29.5	66	36	70	8
L2FP3072R	1383	1721	1829	29	29.5	72	36	75	9
L2FP3078R	1432	1798	1906	29	29.5	78	36	77	9
L2FP3084R	1491	1884	1985	29	29.5	84	36	81	10
L2FP3660R	1353	1684	1803	29	29.5	60	42	70	9
L2FP3666R	1403	1765	1890	29	29.5	66	42	76	9
L2FP3672R	1456	1846	1981	29	29.5	72	42	81	10
L2FP3678R	1512	1930	2071	29	29.5	78	42	84	11
L2FP3684R	1577	2025	2163	29	29.5	84	42	88	11
<b>Left</b>									
L2FP3060L	1290	1577	1673	29	29.5	60	36	66	8
L2FP3066L	1335	1650	1752	29	29.5	66	36	70	8
L2FP3072L	1383	1721	1829	29	29.5	72	36	75	9
L2FP3078L	1432	1798	1906	29	29.5	78	36	77	9
L2FP3084L	1491	1884	1985	29	29.5	84	36	81	10
L2FP3660L	1353	1684	1803	29	29.5	60	42	70	9
L2FP3666L	1403	1765	1890	29	29.5	66	42	76	9
L2FP3672L	1456	1846	1981	29	29.5	72	42	81	10
L2FP3678L	1512	1930	2071	29	29.5	78	42	84	11
L2FP3684L	1577	2025	2163	29	29.5	84	42	88	11

**L2FW • Floating Wedge-Shaped With Legs and Spacers**

• Add \$415 to list price for chrome leg option.

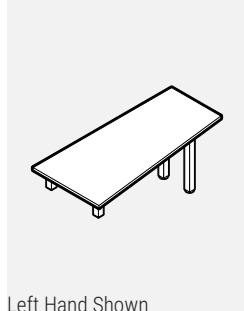

Left Hand Shown

PRODUCT CODE	FINISH LP	B	W	SIZE/INCHES			WEIGHT LBS	VOL FT <sup>3</sup>	
				H(LP/B)	H(W)	D			
<b>Right</b>									
L2FW3060R	1290	1534	1594	29	29.5	60	30	53	7
L2FW3066R	1337	1604	1716	29	29.5	66	30	57	7
L2FW3072R	1382	1668	1740	29	29.5	72	30	62	8
L2FW3078R	1432	1743	1814	29	29.5	78	30	64	8
L2FW3084R	1493	1824	1885	29	29.5	84	30	68	9
L2FW3660R	1351	1640	1721	29	29.5	60	36	57	8
L2FW3666R	1403	1717	1808	29	29.5	66	36	63	8
L2FW3672R	1457	1794	1887	29	29.5	72	36	68	9
L2FW3678R	1511	1872	1971	29	29.5	78	36	70	9
L2FW3684R	1577	1965	2078	29	29.5	84	36	75	10
<b>Left</b>									
L2FW3060L	1290	1534	1594	29	29.5	60	30	53	7
L2FW3066L	1337	1604	1716	29	29.5	66	30	57	7
L2FW3072L	1382	1668	1740	29	29.5	72	30	62	8
L2FW3078L	1432	1743	1814	29	29.5	78	30	64	8
L2FW3084L	1493	1824	1885	29	29.5	84	30	68	9
L2FW3660L	1351	1640	1721	29	29.5	60	36	57	8
L2FW3666L	1403	1717	1808	29	29.5	66	36	63	8
L2FW3672L	1457	1794	1887	29	29.5	72	36	68	9
L2FW3678L	1511	1872	1971	29	29.5	78	36	70	9
L2FW3684L	1577	1965	2078	29	29.5	84	36	75	10

**L2FBR • Floating Top Rectangular With Legs (Spacers Sold Separately)**

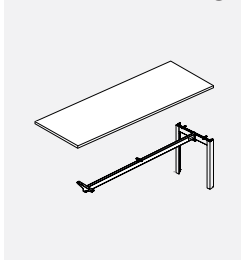

- Anodized aluminum leg upcharge \$44.
- Due to beam location, grommet is only available as a special request, please contact your customer service representative.
- Worksurface supporting pedestals and laterals will not fit due to the metal channel under the surface.

PRODUCT CODE	FINISH LP	B	W	SIZE / INCHES			D	WEIGHT LBS	VOL FT <sup>3</sup>
				H (LP/B)	H (W)	W			
L2FBR2466	1080	1238	1371	1	1.44	66	24	51	6
L2FBR2472	1112	1286	1426	1	1.44	72	24	55	6
L2FBR2478	1156	1344	1494	1	1.44	78	24	59	7
L2FBR2484	1207	1407	1569	1	1.44	84	24	62	7
L2FBR3066	1167	1365	1518	1	1.44	66	30	53	8
L2FBR3072	1205	1421	1588	1	1.44	72	30	57	8
L2FBR3078	1252	1488	1666	1	1.44	78	30	62	9
L2FBR3084	1308	1560	1752	1	1.44	84	30	64	9

**L2SPBOX • Laminate Spacers With Glass Shelf**

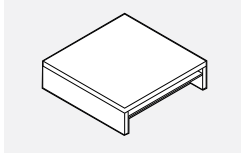

- Glazing is clear.

PRODUCT CODE	PRICE LP	SIZE / INCHES			WEIGHT LBS	VOL FT <sup>3</sup>
		H	W	D		
L2SPBOX1620	709	8	16	20	15	1
L2SPBOX1626	795	8	16	26	18	2
L2SPBOX1634	901	8	16	34	22	5

**L2FFL • Licence Floating Tops With "O" Leg**

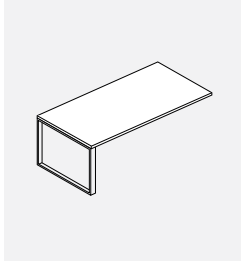

- Kit includes a worksurface, "O" leg and channel.
- Option for grommet - BG5, TC only.
- Painted loop leg, please specify standard paint color.
- Worksurface supporting pedestals and laterals will not fit due to the metal channel under the surface.

PRODUCT CODE	FINISH LP	B	W	SIZE / INCHES			D	WEIGHT LBS	VOL FT <sup>3</sup>
				H (LP/B)	H (W)	W			
L2FFL2466	1096	1238	1373	1	1.44	66	24	55	6
L2FFL2472	1123	1273	1445	1	1.44	72	24	59	7
L2FFL2478	1165	1319	1502	1	1.44	78	24	62	7
L2FFL2484	1214	1380	1574	1	1.44	84	24	66	8
L2FFL3066	1194	1346	1607	1	1.44	66	30	57	7
L2FFL3072	1232	1388	1686	1	1.44	72	30	62	8
L2FFL3078	1270	1432	1766	1	1.44	78	30	64	8
L2FFL3084	1339	1516	1850	1	1.44	84	30	68	9
L2FFL3666	1463	1628	1884	1	1.44	66	36	63	8
L2FFL3672	1524	1702	1980	1	1.44	72	36	68	9
L2FFL3678	1588	1781	2080	1	1.44	78	36	70	9
L2FFL3684	1656	1862	2181	1	1.44	84	36	75	10

**L2HGAMP • Hanging Aluminum-Framed Frosted Glazing Modesty**

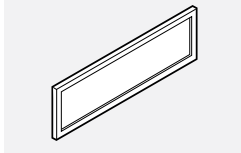

- Framed is anodize aluminum.
- Glazing is frosted acrylic.
- Hanging brackets are included.

PRODUCT CODE	PRICE	SIZE / INCHES			WEIGHT LBS	VOL FT <sup>3</sup>
		H	W	D		
L2HGAMP36	637	14	35.50	0.75	12	1
L2HGAMP42	685	14	41.50	0.75	13	1
L2HGAMP48	733	14	47.50	0.75	14	1
L2HGAMP54	782	14	53.50	0.75	16	1

**L2HGMP • Hanging Laminate Modesty**

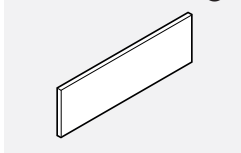

- Hanging brackets are included.

PRODUCT CODE	PRICE LP	SIZE / INCHES			WEIGHT LBS	VOL FT <sup>3</sup>
		H	W	D		
L2HGMP36	285	14	36	0.75	9	1
L2HGMP42	296	14	42	0.75	11	1
L2HGMP48	303	14	48	0.75	13	1
L2HGMP54	311	14	54	0.75	14	1

**GENERAL NOTES**

**Pedestals**

**• Pedestals are shipped assembled.**

- Pedestals are offered in three types of applications: Worksurface-Supporting, Freestanding, and Mobile.
- Pedestal front width is 15-1/2" with a deep size variation 18" 23" 24" 29" 30" 36"
- If specifying a pedestal for a desk or credenza, please ensure you specify next depth lower ie. 23" deep pedestal for a 24" deep credenza or desk.
- Worksurface supporting Pedestals are 28"high
- Freestanding pedestals come with the choice of "LP", "B" for 29"high or "W" thickness top for 29.5"high
- Pedestals Freestanding are on adjustable levelers
- Mobile pedestals come with a top with the choice of "LP", "B" for 29"high or "W" thickness top for 29.5"high and have front locking casters to support the pedestal.
- Pencil tray included in the top box drawer of each pedestal.
- Box drawers mounted on full extension ball bearing slides
- File drawers mounted on full extension ball bearing slides
- All file drawers come with adjustable rails for legal or letter size hanging folders. See File Drawer Capacity chart page G2.
- Pull out shelf for CPU and printer units can support 75 lbs. per shelf and has telescopic extension.
- CPU and printer units have ventilation grommet on back panel.
- Interior clearance of printer shelf is 11".
- Printer pedestals have 2 pull out shelves and the back panel has four round grommets.
- CPU pedestals have 1 pull out shelf and the back panel has two round grommets.
- Both CPU and printer units must be installed under a worksurface to prevent tipping.
- All pedestals with a door, include 1 adjustable shelf.
- Cases and fronts are finished in low pressure laminate.
- Specify thickness of the top to match the thickness of the worksurface.
- Locks are standard on all units. Available in black or silver finish. The lock will match the handle finish.

**Hutches and Overheads**

**• Hutches and overheads are shipped assembled.**

- Hutches and overheads are offered in "LP" and "W" thickness with three option heights . See Storage Technical Info page G3.
- Specify thickness of hutch or overhead top to match the thickness of the worksurface.
- Cases and fronts are finished in low pressure laminate.
- Hutches and overheads with hinged doors (laminate or aluminum), flip up fronts have no handle option.
- Hutches with pigeon holes come with touch latch mechanism.
- Hutches and overheads with sliding laminate doors have standard handle options
- Hutches and overheads with sliding glass doors are offered with recessed handle only. The recessed handle is in chrome finish.
- Hutches and wall mounted overheads are offered in 4 styles: Open storage, Hinged doors - laminate or anodized aluminum frame doors with the option for glazing : frosted or clear, sliding doors are laminate or glass doors and flip-up doors.
- Once installed, the bottom of the flip-up door overhead will not line up with the bottom of the open or hinged door overhead.
- Wall mounted storage cabinets must be securely attached to wall studs.
- Panel-mounted overheads include attachment brackets for Boulevard panels.
- Back panels on hutches comes with a center round grommet for wire access.
- Top on hutch and overhead storage cabinets with flip-up doors is 3/4" thick Low Pressure Laminate. Doors slides on top of the unit.
- Inside dimension for hutches and wall mounted units with flip-up doors is 13 1/4" high x 14 1/2" deep.
- Inside dimension for hutches and wall mounted with hinged doors is 12 3/4" high x 15 1/4" deep.
- Inside dimension for open hutches and wall mounted is 12 3/4" high x 15 1/4" deep.
- Inside dimension for hutches and wall mounted with sliding doors is 12-3/4"high x 13" deep.
- Use double-sided tape to attach hutches to worksurface.
- Locks are standard on all units. Available in black or silver finish. The lock will match the handle finish.
- Recommended to be installed against and fixed to a wall using appropriate hardware (not included).

**Credenzas**

**• Credenzas are shipped assembled.**

- Credenza model # L2CR2H2H or L2CR1H1H must be ordered with counterweights to avoid tipping.
- Credenza come with the choice of "LP", "B" or "W" thickness top.
- Credenzas are offered with the choice of "LP", "B" for 20"h. or 29"high and "W" thickness top for 20.5"h or 29.5"high.
- Credenza come with hinged doors, laminate or anodized aluminum frame doors with the option for glazing : frosted or clear.
- Locks are standard on all units. Available in black or silver finish. The lock will match the handle finish.

**Bookcases**

**• Bookcases are Shipped knocked down (KD).**

- Available in 30" or 36" widths and 12.685" and 16.685"depths dimension at baseboard with range in height from 29" to 72" with 12" clearance between shelves.
- Bottom shelf is fixed and all other shelves are adjustable.
- Specify thickness of the top to match the thickness and profile of the worksurface.
- Tops are offered "LP" or "B" or "W".
- Up to 42"h, Bookcases are offered in "LP" , "B", "W".
- 54"h. and up are offered in "LP" and "W".
- Recommended to be installed against and fixed to a wall using appropriate hardware (not included).

**Laterals**

**• Laterals are shipped assembled.**

- Laterals are available in three widths, 30" 36", 42" with a height variation of 28" to 54" and a depth of 20" and 24".
- Tops are offered LP, B or W.
- Worksurface supporting units do not come with a top.
- Up to 42"h, laterals are offered in "LP" , "B", "W".
- 54"h and Up are offered in "LP" and "W".
- Cases and fronts are finished in low pressure laminate.
- Laterals with hinged doors, laminate or anodized aluminum frame doors with the option for glazing: frosted or clear.
- Lateral files are offered in 2 types of applications: Worksurface-Supporting and Freestanding.
- All lateral files feature a drawer interlocking mechanism.
- Up to 42"h, Laterals are offered in "LP" , "B", "W".
- 54"h, and up are offered in "LP" and "W".
- All file drawer come with adjustable rails for legal or letter size hanging folders.
- Counterweights must be specified in a lateral configurations except worksurface-supporting.
- "C" combo lateral have a pencil drawer included in the box drawer. The pencil tray is parallel with the depth of the drawer.
- In "C" combo lateral, only one side can be locked.
- All laterals with a door, include 1 adjustable shelf.
- File drawers mounted on full extension ball bearing slides.
- Locks are standard on all units. Available in black or silver finish. The lock will match the handle finish.

**Towers and cabinets**

**• Towers and cabinets are shipped assembled.**

- Towers offered 24"w and cabinets 30"w and 36"w are offered in "LP" and "W".
- Cases are finished in low pressure laminate.
- Towers or cabinets are offered with hinged doors, laminate or anodized aluminum frame with the option for glazing: frosted or clear.
- Towers or cabinets with anodized aluminum doors are offered without handles. Touch latch mechanism is included.
- Storage tower with the cupboard above FF or BBF and wardrobe will lock only the wardrobe and drawers.
- Storage tower with the wardrobe include a coat rod.
- Locks are standard on all units. Available in black or silver finish. The lock will match the handle finish.
- Counterweights must be specified for units 20" deep by 60" to 72" high with 2H2D or 2H/Open, please order 2 x LACWB for each unit.

## LATERAL FILE DRAWERS

**Lateral File Drawer:**

36W &amp; 42W

Legal Filing - front to back

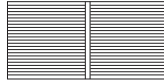

Drawer file with plastic rail

30"W Size 9.44"H x 25.75"W x 16"L

36"W Size 9.44"H x 31.75"W x 16"L

42"W Size 9.44"H x 37.75"W x 16"L

**Lateral File Drawer:**

36W &amp; 42W

Legal Filing - side to side

Letter Filing - front to back

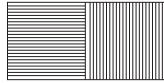
**Lateral File Drawer:**

30W, 36W &amp; 42W

Letter Filing - front to back

**Lateral File Drawer:**

36W &amp; 42W

Letter &amp; Legal Filing - front to back

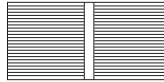
**Lateral File Drawer:**

30W, 36W &amp; 42W

Legal Filing - side to side

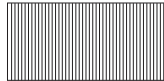

## PEDESTAL DRAWERS

**Box Drawer:**

15.5W

Legal Filing - side to side



18"D Drawer Box Size 3.93"H x 13"W x 16"L

20.23.24.29.30.36"D Drawer Box Size 3.93"H x 13"W x 20"L

**File Drawer:**

15.5W

Letter Filing - front to back



18"D Drawer File with plastic rail Size 9.4"H x 13"W x 16"L

20"D and up Drawer File with plastic rail Size 9.4"H x 13"W x 20"L

**File Drawer:**

15.5W

Legal Filing - side to side



18"D Drawer File with plastic rail Size 9.4"H x 13"W x 16"L

20"D and up Drawer File with plastic rail Size 9.4"H x 13"W x 20"L

## COMBO LATERAL FILE DRAWERS

For 30" wide units: Drawer width is 11 3/4" and can accommodate only side to side legal or letter filing.

For 36" wide units: Drawer width is 14 3/4" and can accommodate only side to side legal or letter filing.

**STORAGE TECHNICAL INFORMATION**

**1" LPL TOP  
LP HUTCH  
LP DESK 29H  
LP CABINET**

**1-1/16" HPL TOP  
LP HUTCH  
B TOP DESK 29H  
LP CABINET**

**1-7/16" HPL TOP  
W TOP HUTCH  
W TOP DESK 29.5H  
W CABINET**

**NO TACKBOARD  
LTB  
50"High**

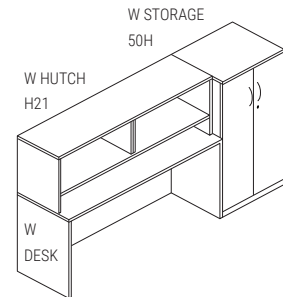
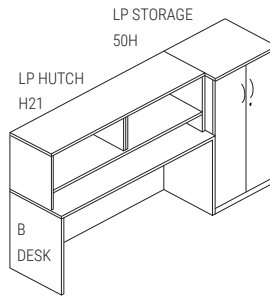
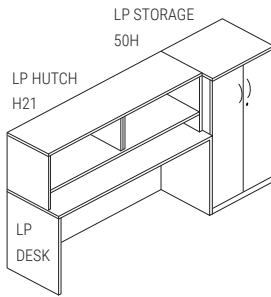

**TACKBOARD  
LTB21  
66" High**

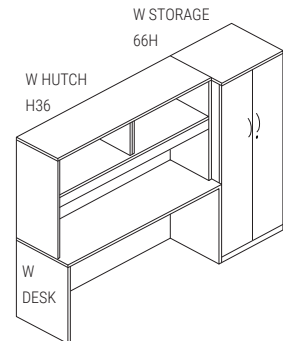
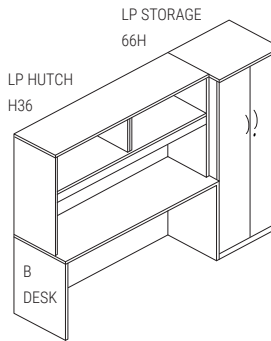
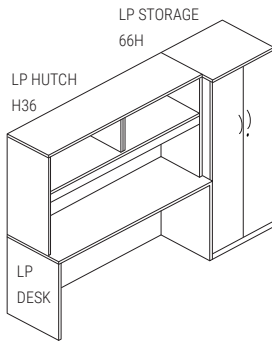

**TACKBOARD  
LTB27  
72" High**

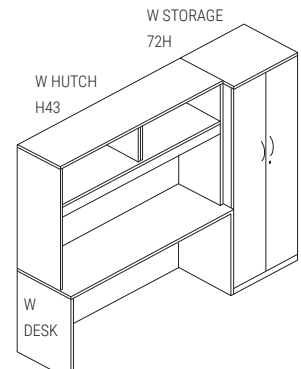
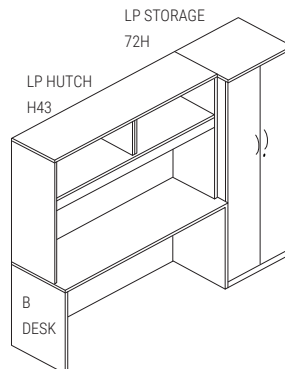
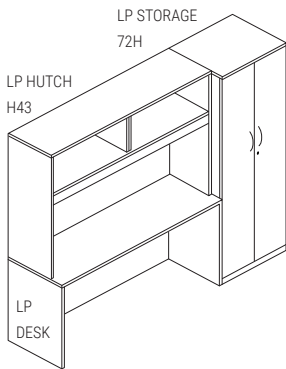

**STACK-ON TWO-HEIGHT CABINET IS TO BE PLACED ON 1-HIGH CREDENZA**

**50" High  
Only**

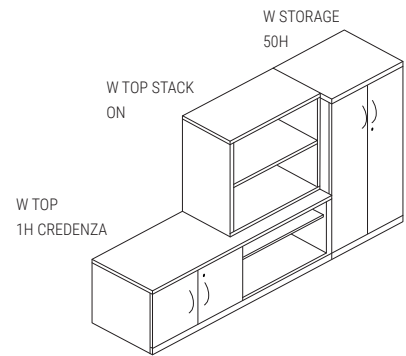
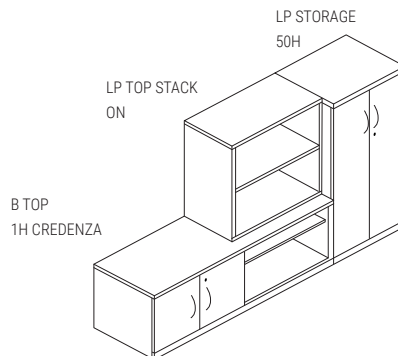
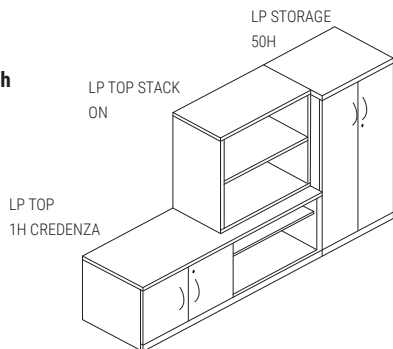

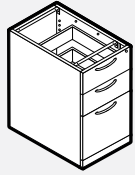

**L2PBBF • Worksurface-Supporting Box/Box/File Pedestal**

- One lock included.
- Optional e-lock available in the vertical position. Please specify V - Vertical and add \$304 list.
- Counter weight must be ordered separately.

PRODUCT CODE	PRICE	SIZE/INCHES			WEIGHT LBS	VOL FT <sup>3</sup>
		H	W	D		
L2PBBF18	1056	28	15.5	18	94	8
L2PBBF20	1151	28	15.5	20	94	8
L2PBBF23	1169	28	15.5	23	94	8
L2PBBF24	1169	28	15.5	24	99	10
L2PBBF29	1211	28	15.5	29	105	10
L2PBBF30	1211	28	15.5	30	110	10
L2PBBF36	1270	28	15.5	36	116	11

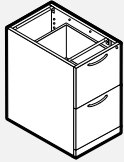
**L2PFF • Worksurface-Supporting File/File Pedestal**

- One lock included.
- Optional e-lock available in the vertical position. Please specify V - Vertical and add \$304 list.

PRODUCT CODE	PRICE	SIZE/INCHES			WEIGHT LBS	VOL FT <sup>3</sup>
		H	W	D		
L2PFF18	960	28	15.5	18	94	8
L2PFF20	1073	28	15.5	20	94	8
L2PFF23	1089	28	15.5	23	94	8
L2PFF24	1089	28	15.5	24	99	8
L2PFF29	1143	28	15.5	29	105	10
L2PFF30	1143	28	15.5	30	110	10
L2PFF36	1188	28	15.5	36	116	11

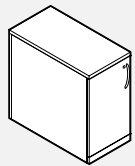
**L2P1D • Worksurface-Supporting 1-Door Pedestal**

- Includes one adjustable shelf.
- One lock included.
- Optional e-lock available in the horizontal position. Please specify HL - Horizontal Left and add \$304 list.

PRODUCT CODE	PRICE	SIZE/INCHES			WEIGHT LBS	VOL FT <sup>3</sup>
		H	W	D		
L2P1D18	806	28	15.5	18	66	8
L2P1D20	869	28	15.5	20	74	8
L2P1D23	891	28	15.5	23	74	8
L2P1D24	891	28	15.5	24	75	10
L2P1D29	977	28	15.5	29	84	10
L2P1D30	977	28	15.5	30	85	10

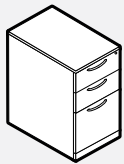
**L2PBBF-F • Freestanding Box/Box/File Pedestal**

- One lock included.
- Optional e-lock available in the vertical position. Please specify V - Vertical and add \$304 list.
- Counter weight must be ordered separately.

PRODUCT CODE	FINISH LP	B	W	SIZE/INCHES				WEIGHT LBS	VOL FT <sup>3</sup>
				H (LP/B)	H (W)	W	D		
L2PBBF20F	1251	1286	1335	29	29.5	15.5	20	94	8
L2PBBF24F	1267	1304	1353	29	29.5	15.5	24	99	8
L2PBBF30F	1319	1364	1421	29	29.5	15.5	30	105	10
L2PBBF36F	1385	1437	1501	29	29.5	15.5	36	116	11

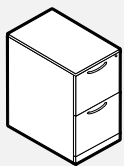
**L2PFF-F • Freestanding File/File Pedestal**

- One lock included.
- Optional e-lock available in the vertical position. Please specify V - Vertical and add \$304 list.
- Counter weight must be ordered separately.

PRODUCT CODE	FINISH LP	B	W	SIZE/INCHES				WEIGHT LBS	VOL FT <sup>3</sup>
				H (LP/B)	H (W)	W	D		
L2PFF20F	1132	1169	1251	29	29.5	15.5	20	99	8
L2PFF24F	1148	1183	1268	29	29.5	15.5	24	99	8
L2PFF30F	1245	1289	1342	29	29.5	15.5	30	110	10
L2PFF36F	1350	1404	1425	29	29.5	15.5	36	116	11

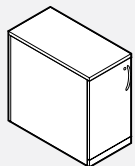
**L2P1D-F • Freestanding 1-Door Pedestal**

- Includes one adjustable shelf.
- One lock included.
- Optional e-lock available in the horizontal position. Please specify HL - Horizontal Left and add \$304 list.
- Counter weight must be ordered separately.

PRODUCT CODE	FINISH LP	B	W	SIZE/INCHES				WEIGHT LBS	VOL FT <sup>3</sup>
				H (LP/B)	H (W)	W	D		
L2P1D20F	965	1031	1078	29	29.5	15.5	20	78	8
L2P1D24F	981	1048	1092	29	29.5	15.5	24	98	8
L2P1D30F	1078	1161	1215	29	29.5	15.5	30	103	10
L2P1D36F	1181	1279	1343	29	29.5	15.5	36	110	11

**L2PBFF-MIT • Mobile Box/Box/File Pedestal to fit Under Worksurface**



- One lock included.
- Optional e-lock available in the vertical position. Please specify V - Vertical and add \$304 list.
- Counter weight must be ordered separately.
- 18" deep mobile pedestal has a fifth caster at center bottom.

PRODUCT CODE	PRICE	SIZE/INCHES			WEIGHT LBS	VOL FT <sup>3</sup>
		H	W	D		
L2PBFF18MIT	1522	28	15.5	18	99	8
L2PBFF23MIT	1610	28	15.5	23	105	8
L2PBFF29MIT	1690	28	15.5	29	110	10

**L2PBFF-M • Mobile Box/Box/File Pedestal With Standard Top**



- One lock included.
- Optional e-lock available in the vertical position. Please specify V - Vertical and add \$304 list.
- Counter weight must be ordered separately.
- 20" deep mobile pedestal has a fifth caster at center bottom.

PRODUCT CODE	FINISH LP	B	W	SIZE/INCHES				WEIGHT LBS	VOL FT <sup>3</sup>
				H (LP/B)	H (W)	W	D		
L2PBFF20M	1642	1652	1728	29	29.5	15.5	20	99	8
L2PBFF24M	1668	1679	1755	29	29.5	15.5	24	99	8
L2PBFF30M	1702	1743	1799	29	29.5	15.5	30	105	10
L2PBFF36M	1772	1819	1872	29	29.5	15.5	36	110	11

**L2PFF-MIT • Mobile File/File Pedestal to fit Under Worksurface**

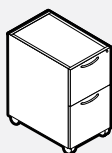

- One lock included.
- Optional e-lock available in the vertical position. Please specify V - Vertical and add \$304 list.
- Counter weight must be ordered separately.
- 18" deep mobile pedestal has a fifth caster at center bottom.

PRODUCT CODE	PRICE	SIZE/INCHES			WEIGHT LBS	VOL FT <sup>3</sup>
		H	W	D		
L2PFF18MIT	1300	28	15.5	18	99	8
L2PFF23MIT	1383	28	15.5	23	105	8
L2PFF29MIT	1452	28	15.5	29	110	10

**L2PFF-M • Mobile File/File Pedestal With Standard Top**

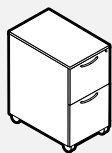

- One lock included.
- Optional e-lock available in the vertical position. Please specify V - Vertical and add \$304 list.
- Counter weight must be ordered separately.
- 20" deep mobile pedestal has a fifth caster at center bottom.

PRODUCT CODE	FINISH LP	B	W	SIZE/INCHES				WEIGHT LBS	VOL FT <sup>3</sup>
				H (LP/B)	H (W)	W	D		
L2PFF20M	1391	1425	1467	29	29.5	15.5	20	99	8
L2PFF24M	1413	1446	1490	29	29.5	15.5	24	99	8
L2PFF30M	1463	1504	1582	29	29.5	15.5	30	105	10
L2PFF36M	1537	1587	1642	29	29.5	15.5	36	110	11

**L2PBF-M • Mobile Box/File Pedestal With Standard Top**



- One lock included.
- Optional e-lock available in the vertical position. Please specify V - Vertical and add \$304 list.
- Counter weight must be ordered separately.
- 20" deep mobile pedestal has a fifth caster at center bottom.

PRODUCT CODE	FINISH LP	B	W	SIZE/INCHES				WEIGHT LBS	VOL FT <sup>3</sup>
				H (LP/B)	H (W)	W	D		
L2PBF20M	1214	1251	1317	22.69	23.15	15.5	20	78	7
L2PBF24M	1229	1267	1335	22.69	23.15	15.5	24	80	7
L2PBF30M	1270	1316	1369	22.69	23.15	15.5	30	90	9

**L2PBF-MIT • Mobile Box/File Pedestal With Inset Top**



- One lock included.
- Optional e-lock available in the vertical position. Please specify V - Vertical and add \$304 list.
- Counter weight must be ordered separately.
- 18" deep mobile pedestal has a fifth caster at center bottom.

PRODUCT CODE	PRICE	SIZE/INCHES			WEIGHT LBS	VOL FT <sup>3</sup>
		H	W	D		
L2PBF18MIT	1135	22	15.5	18	99	8
L2PBF23MIT	1208	22	15.5	23	99	8
L2PBF24MIT	1208	22	15.5	24	105	8
L2PBF29MIT	1275	22	15.5	29	105	8
L2PBF30MIT	1275	22	15.5	30	110	10

**L2PU • Printer Unit With 2 Pull-Out Shelves**

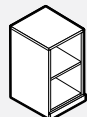

PRODUCT CODE	PRICE	SIZE/INCHES			WEIGHT LBS	VOL FT <sup>3</sup>
		H (LP/B)	W	D		
L2PU18	1164	28	22	18	83	8
L2PU22	1264	28	22	22	88	9
L2PU24	1319	28	22	24	94	10

**L2L2H • Worksurface-Supporting File/File Lateral for 18" Deep and 22" Deep Units**

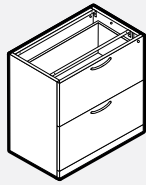

- One lock included.
- Optional e-lock available in the vertical position. Please specify V - Vertical and add \$304 list.

PRODUCT CODE	PRICE	SIZE / INCHES			WEIGHT LBS	VOL FT <sup>3</sup>
		H (LP/B)	W	D		
L2L2H1830	1550	28	30	18	189	12
L2L2H1836	1648	28	36	18	209	14
L2L2H1842	1713	28	42	18	216	20
L2L2H2230	1592	28	30	22	189	12
L2L2H2236	1695	28	36	22	209	14
L2L2H2242	1814	28	42	22	216	20

**L2L2D • Worksurface-Supporting 2-Door Storage Lateral With 1 Adjustable Shelf**

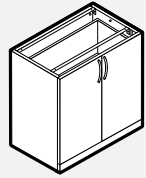

- One lock included.
- Optional e-lock available in the horizontal position. Please specify HR - Horizontal Right and add \$304 list.

PRODUCT CODE	PRICE	SIZE / INCHES			WEIGHT LBS	VOL FT <sup>3</sup>
		H (LP/B)	W	D		
L2L2D1830	1081	28	30	18	171	12
L2L2D1836	1139	28	36	18	178	14
L2L2D1842	1252	28	42	18	180	20
L2L2D2230	1170	28	30	22	171	12
L2L2D2236	1203	28	36	22	178	14
L2L2D2242	1385	28	42	22	180	20

**L2L2AD • Worksurface-Supporting 2-Aluminum-Door Storage Lateral With 1 Adjustable Shelf**

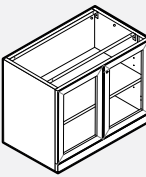

- One lock included.
- E-lock not available for aluminum-framed glass doors.

PRODUCT CODE	PRICE	SIZE / INCHES			WEIGHT LBS	VOL FT <sup>3</sup>
		H (LP/B)	W	D		
L2L2AD1830	1866	28	30	18	165	12
L2L2AD1836	1999	28	36	18	172	14
L2L2AD1842	2185	28	42	18	174	20
L2L2AD2230	1954	28	30	22	165	12
L2L2AD2236	2063	28	36	22	172	14
L2L2AD2242	2317	28	42	22	174	20

**L2LCR • Worksurface-Supporting Lateral File Combo**

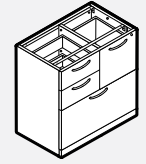

- One lock included.
- Optional e-lock available in the vertical position. Please specify V - Vertical and add \$304 list.

PRODUCT CODE	PRICE	SIZE / INCHES			WEIGHT LBS	VOL FT <sup>3</sup>
		H (LP/B)	W	D		
L2LCR1830	1899	28	30	18	204	12
L2LCR1836	2218	28	36	18	215	14
L2LCR2230	2208	28	30	22	204	12
L2LCR2236	2320	28	36	22	215	14

**L2LCL • Worksurface-Supporting Lateral File Combo**

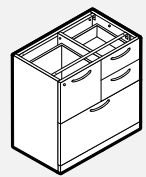

- One lock included.
- E-lock not available.

PRODUCT CODE	PRICE	SIZE / INCHES			WEIGHT LBS	VOL FT <sup>3</sup>
		H (LP/B)	W	D		
L2LCL1830	1899	28	30	18	204	12
L2LCL1836	2218	28	36	18	215	14
L2LCL2230	2208	28	30	22	204	12
L2LCL2236	2320	28	36	22	215	14

**L2LCR • Lateral File Combo With Top**

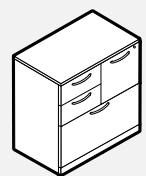

- One lock included.
- Optional e-lock available in the vertical position. Please specify V - Vertical and add \$304 list.

PRODUCT CODE	FINISH LP	B	W	SIZE / INCHES			WEIGHT LBS	VOL FT <sup>3</sup>	
				H (LP/B)	H (W)	D			
L2LCR2030	2346	2400	2461	29	29.5	30	20	204	12
L2LCR2036	2460	2493	2618	29	29.5	36	20	215	14
L2LCR2430	2440	2494	2562	29	29.5	30	24	204	12
L2LCR2436	2558	2595	2726	29	29.5	36	24	215	14

**L2LCL • Lateral File Combo With Top**

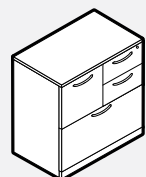

- One lock included.
- E-lock not available.

PRODUCT CODE	FINISH LP	B	W	SIZE / INCHES			WEIGHT LBS	VOL FT <sup>3</sup>	
				H (LP/B)	H (W)	D			
L2LCL2030	2346	2400	2461	29	29.5	30	20	204	12
L2LCL2036	2460	2493	2618	29	29.5	36	20	215	14
L2LCL2430	2440	2494	2562	29	29.5	30	24	204	12
L2LCL2436	2558	2595	2726	29	29.5	36	24	215	14

**L2LO • Freestanding 1-High Open Unit**

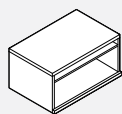

PRODUCT CODE	FINISH			SIZE/INCHES				WEIGHT		VOL FT <sup>3</sup>
	LP	B	W	H(LP/B)	H(W)	W	D	LBS		
L2LO2030	837	952	1031	19.94	20.4	30	20	75	11	
L2LO2036	994	1130	1176	19.94	20.4	36	20	86	13	
L2LO2430	870	989	1036	19.94	20.4	30	24	75	11	
L2LO2436	1035	1176	1223	19.94	20.4	36	24	86	13	

**L2L2D-H20 • Freestanding 2 Doors, 1-High Unit**

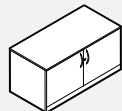

- One lock included.
- Includes one adjustable shelf.
- Optional e-lock available in the horizontal position. Please specify HR - Horizontal Right and add \$304 list.

PRODUCT CODE	FINISH			SIZE/INCHES				WEIGHT		VOL FT <sup>3</sup>
	LP	B	W	H(LP/B)	H(W)	W	D	LBS		
L2L2D2030H20	1148	1251	1312	19.94	20.4	30	20	95	11	
L2L2D2036H20	1251	1372	1441	19.94	20.4	36	20	106	13	
L2L2D2430H20	1196	1300	1367	19.94	20.4	30	24	95	11	
L2L2D2436H20	1300	1425	1500	19.94	20.4	36	24	106	13	

**L2L2AD • Freestanding 2 Aluminum Doors, 1-High Unit**

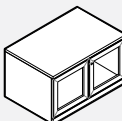

- One lock included.
- Includes one adjustable shelf.
- E-lock not available for aluminum-framed glass doors.

PRODUCT CODE	FINISH			SIZE/INCHES				WEIGHT		VOL FT <sup>3</sup>
	LP	B	W	H(LP/B)	H(W)	W	D	LBS		
L2L2AD2030H20	1783	1885	1950	19.5	20	30	20	86	10	
L2L2AD2036H20	1938	2061	2130	19.5	20	36	20	96	12	
L2L2AD2430H20	1831	1937	2006	19.5	20	30	24	86	10	
L2L2AD2436H20	1988	2115	2190	19.5	20	36	24	96	12	

**L2L2D • Freestanding 2 Doors, 2-High Unit**

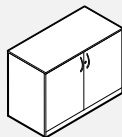

- One lock included.
- Includes one adjustable shelf.
- Optional e-lock available in the horizontal position. Please specify HR - Horizontal Right and add \$304 list.

PRODUCT CODE	FINISH			SIZE/INCHES				WEIGHT		VOL FT <sup>3</sup>
	LP	B	W	H(LP/B)	H(W)	W	D	LBS		
L2L2D2030	1267	1407	1445	29	29.5	30	20	171	12	
L2L2D2036	1396	1516	1591	29	29.5	36	20	178	14	
L2L2D2042	1563	1702	1781	29	29.5	42	20	208	20	
L2L2D2430	1316	1466	1504	29	29.5	30	24	171	12	
L2L2D2436	1452	1578	1652	29	29.5	36	24	178	14	
L2L2D2442	1624	1770	1856	29	29.5	42	24	208	20	

**L2L2AD • Freestanding 2 Aluminum Doors, 2-High Unit**

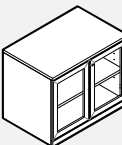

- One lock included.
- Includes one adjustable shelf.
- E-lock not available for aluminum-framed glass doors.

PRODUCT CODE	FINISH			SIZE/INCHES				WEIGHT		VOL FT <sup>3</sup>
	LP	B	W	H(LP/B)	H(W)	W	D	LBS		
L2L2AD2030	2053	2197	2234	29	29.5	30	20	165	12	
L2L2AD2036	2261	2384	2455	29	29.5	36	20	172	14	
L2L2AD2042	2501	2644	2724	29	29.5	42	20	174	20	
L2L2AD2430	2104	2254	2293	29	29.5	30	24	165	12	
L2L2AD2436	2316	2445	2519	29	29.5	36	24	172	14	
L2L2AD2442	2563	2710	2796	29	29.5	42	24	174	20	

**L2L1H • Freestanding 1-High Lateral Unit**

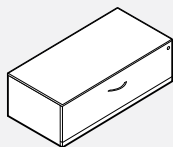

- One lock included.
- Optional e-lock available in the vertical position. Please specify V - Vertical and add \$304 list.

PRODUCT CODE	FINISH			SIZE/INCHES				WEIGHT		VOL FT <sup>3</sup>
	LP	B	W	H(LP/B)	H(W)	W	D	LBS		
L2L1H2030	1142	1207	1248	19.94	20.4	30	20	105	11	
L2L1H2036	1221	1296	1364	19.94	20.4	36	20	114	13	
L2L1H2042	1319	1404	1484	19.94	20.4	42	20	133	15	
L2L1H2430	1187	1252	1297	19.94	20.4	30	24	105	11	
L2L1H2436	1270	1346	1419	19.94	20.4	36	24	114	13	
L2L1H2442	1373	1462	1543	19.94	20.4	42	24	133	15	

**L2LBFH20 • Freestanding Box/File Lateral Unit**

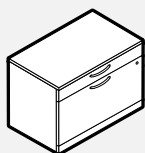

- One lock included.
- Optional e-lock available in the vertical position. Please specify V - Vertical and add \$304 list.

PRODUCT CODE	FINISH			SIZE/INCHES				WEIGHT		VOL FT <sup>3</sup>
	LP	B	W	H(LP/B)	H(W)	W	D	LBS		
L2LBF2030H20	1753	1800	1894	19.94	20	30	20	108	11	
L2LBF2036H20	1886	1941	2050	19.94	20	36	20	117	13	
L2LBF2042H20	2009	2070	2195	19.94	20	42	20	136	15	
L2LBF2430H20	1817	1864	1958	19.94	20	30	24	108	11	
L2LBF2436H20	1951	2005	2114	19.94	20	36	24	117	13	
L2LBF2442H20	2074	2135	2259	19.94	20	42	24	136	15	

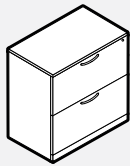
**L2L2H • Freestanding 2-High Lateral Unit**

- One lock included.
- Optional e-lock available in the vertical position. Please specify V - Vertical and add \$304 list.

PRODUCT CODE	FINISH LP	B	W	SIZE/INCHES				D	WEIGHT LBS	VOL FT <sup>3</sup>
				H (LP/B)	H (W)	W	D			
L2L2H2030	1728	1788	1853	29	29.5	30	20	189	12	
L2L2H2036	1852	1922	1991	29	29.5	36	20	209	14	
L2L2H2042	1988	2073	2142	29	29.5	42	20	242	20	
L2L2H2430	1799	1860	1927	29	29.5	30	24	189	12	
L2L2H2436	1923	1997	2071	29	29.5	36	24	209	14	
L2L2H2442	2068	2155	2229	29	29.5	42	24	242	20	

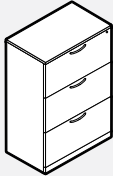
**L2L3H • Freestanding 3-High Lateral Unit**

- One lock included.
- Optional e-lock available in the vertical position. Please specify V - Vertical and add \$304 list.

PRODUCT CODE	FINISH LP	B	W	SIZE/INCHES				D	WEIGHT LBS	VOL FT <sup>3</sup>
				H (LP/B)	H (W)	W	D			
L2L3H2030	2360	2419	2486	41.75	42.18	30	20	252	18	
L2L3H2036	2543	2613	2630	41.75	42.18	36	20	264	21	
L2L3H2430	2456	2516	2584	41.75	42.18	30	24	252	18	
L2L3H2436	2645	2720	2735	41.75	42.18	36	24	264	21	

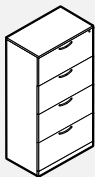
**L2L4H • Freestanding 4-High Lateral Unit**

- One lock included.
- Optional e-lock available in the vertical position. Please specify V - Vertical and add \$304 list.

PRODUCT CODE	FINISH LP	W	SIZE/INCHES				D	WEIGHT LBS	VOL FT <sup>3</sup>
			H (LP/B)	H (W)	W	D			
L2L4H2030	3051	3178	54.5	54.94	30	20	315	23	
L2L4H2036	3206	3390	54.5	54.94	36	20	336	28	
L2L4H2430	3172	3303	54.5	54.94	30	24	315	23	
L2L4H2436	3334	3525	54.5	54.94	36	24	336	28	

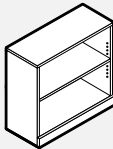
**L2B2H • Bookcase 1 Adjustable Shelf**

- Shipped knocked down (KD).

PRODUCT CODE	FINISH LP	B	W	SIZE/INCHES				D	WEIGHT LBS	VOL FT <sup>3</sup>
				H (LP/B)	H (W)	W	D			
L2B2H3012	676	739	795	29	29.5	30	12	95	8	
L2B2H3612	784	858	932	29	29.5	36	12	106	9	
L2B2H30	806	896	989	29	29.5	30	17	95	11	
L2B2H36	930	1003	1078	29	29.5	36	17	106	13	

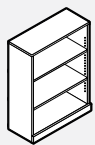
**L2B3H • Bookcase 2 Adjustable Shelves**

- Shipped knocked down (KD).

PRODUCT CODE	FINISH LP	B	W	SIZE/INCHES				D	WEIGHT LBS	VOL FT <sup>3</sup>
				H (LP/B)	H (W)	W	D			
L2B3H3012	865	925	965	41.75	42.18	30	12	160	9	
L2B3H3612	950	1043	1090	41.75	42.18	36	12	171	12	
L2B3H30	1076	1166	1268	41.75	42.18	30	17	160	15	
L2B3H36	1246	1349	1391	41.75	42.18	36	17	171	18	

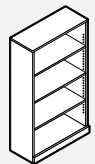
**L2B4H • Bookcase 3 Adjustable Shelves**

- Shipped knocked down (KD).

PRODUCT CODE	FINISH LP	W	SIZE/INCHES				D	WEIGHT LBS	VOL FT <sup>3</sup>
			H (LP/B)	H (W)	W	D			
L2B4H3012	1033	1176	54.5	54.94	30	12	178	13	
L2B4H3612	1157	1321	54.5	54.94	36	12	189	15	
L2B4H30	1312	1464	54.5	54.94	30	17	178	19	
L2B4H36	1436	1575	54.5	54.94	36	17	189	22	

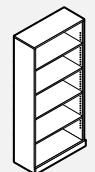
**L2B5H • Bookcase 4 Adjustable Shelves**

- Shipped knocked down (KD).

PRODUCT CODE	FINISH LP	W	SIZE/INCHES				D	WEIGHT LBS	VOL FT <sup>3</sup>
			H (LP/B)	H (W)	W	D			
L2B5H3012	1245	1386	65.81	66.25	30	12	193	15	
L2B5H3612	1356	1526	65.81	66.25	36	12	204	19	
L2B5H30	1474	1594	65.81	66.25	30	17	193	23	
L2B5H36	1647	1825	65.81	66.25	36	17	204	28	

**L2B6H • Bookcase 5 Adjustable Shelves**

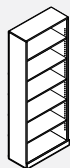

- Shipped knocked down (KD).

PRODUCT CODE	FINISH		SIZE/INCHES				WEIGHT LBS	VOL FT <sup>3</sup>
	LP	W	H(LP/B)	H(W)	W	D		
L2B6H3012	1342	1510	72.81	73.24	30	12	237	17
L2B6H3612	1504	1704	72.81	73.24	36	12	248	20
L2B6H30	1511	1695	72.81	73.24	30	17	242	25
L2B6H36	1806	2067	72.81	73.24	36	17	253	30

**L2BC • Corner Bookcase 20"D x 20"W /24"D x 24"W**

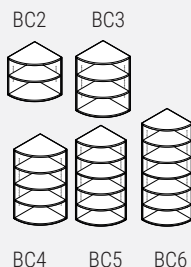

- Shipped knocked down (KD).

PRODUCT CODE	FINISH			SIZE/INCHES				WEIGHT LBS	VOL FT <sup>3</sup>
	LP	B	W	H(LP/B)	H(W)	W	D		
L2BC2H20	1087	1321	1319	29.00	29.50	20	20	90	11
L2BC2H24	1129	1331	1376	29.00	29.50	24	24	90	11
L2BC3H20	1378	1566	1618	41.75	42.18	20	20	125	15
L2BC3H24	1432	1631	1685	41.75	42.18	24	24	125	15
L2BC4H20	1671	-	1916	54.50	54.94	20	20	158	20
L2BC4H24	1738	-	1991	54.50	54.94	24	24	158	20
L2BC5H20	1965	-	2217	65.81	66.25	20	20	188	24
L2BC5H24	2090	-	2304	65.81	66.25	24	24	188	24
L2BC6H20	2207	-	2474	72.81	73.24	20	20	218	26
L2BC6H24	2294	-	2571	72.81	73.24	24	24	218	26

**L2TW2D-D • Storage Tower With 2 Doors and 4 Adjustable Shelves**

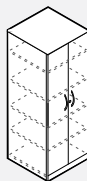

- 50"-High Tower comes with 3 adjustable shelves.
- One lock on right door included.
- Optional e-lock available in the horizontal position. Please specify HR - Horizontal Right and add \$304 list.

PRODUCT CODE	FINISH		SIZE/INCHES				WEIGHT LBS	VOL FT <sup>3</sup>
	LP	W	H(LP/B)	H(W)	W	D		
L2TW2D50H20D	1899	2031	49.56	50.00	24	20	211	22
L2TW2D66H20D	2098	2288	65.81	66.25	24	20	268	24
L2TW2D72H20D	2191	2370	72.81	73.24	24	20	283	26
L2TW2D50H24D	1971	2117	49.56	50.00	24	24	211	22
L2TW2D66H24D	2180	2376	65.81	66.25	24	24	268	24
L2TW2D72H24D	2276	2462	72.81	73.24	24	24	283	26

**L2TW2DCS-D • Storage Tower With 2 Doors, Coat Rod and Hat Shelf**

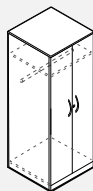

- 50"-High Tower comes with one shelf.
- One lock on right door included.
- Optional e-lock available in the horizontal position. Please specify HR - Horizontal Right and add \$304 list.

PRODUCT CODE	FINISH		SIZE/INCHES				WEIGHT LBS	VOL FT <sup>3</sup>
	LP	W	H(LP/B)	H(W)	W	D		
L2TW2DCS50H20D	1698	1894	49.56	50.00	24	20	178	22
L2TW2DCS66H20D	1922	2063	65.81	66.25	24	20	268	24
L2TW2DCS72H20D	2006	2144	72.81	73.24	24	20	284	26
L2TW2DCS50H24D	1765	1968	49.56	50.00	24	24	178	22
L2TW2DCS66H24D	1996	2141	65.81	66.25	24	24	268	24
L2TW2DCS72H24D	2083	2225	72.81	73.24	24	24	284	26

**L2TW2H2D-D • Storage Tower With a 3-High Cupboard Over a 2-High Lateral Unit**

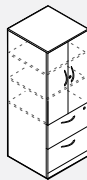

- 50"-High Tower comes with one adjustable shelf.
- Two locks included.
- Optional e-lock available in the vertical position for the file drawers. Please specify V - Vertical and add \$304 list.
- Optional e-lock available in the horizontal position for the upper storage cabinet. Please specify HR - Horizontal Right and add \$304 list.

PRODUCT CODE	FINISH		SIZE/INCHES				WEIGHT LBS	VOL FT <sup>3</sup>
	LP	W	H(LP/B)	H(W)	W	D		
L2TW2H2D50H20D	2569	2622	49.56	50.00	24	20	222	22
L2TW2H2D66H20D	2855	2902	65.81	66.25	24	20	279	24
L2TW2H2D72H20D	2938	3141	72.81	73.24	24	20	295	26
L2TW2H2D50H24D	2673	2730	49.56	50.00	24	24	222	22
L2TW2H2D66H24D	2972	3018	65.81	66.25	24	24	279	24
L2TW2H2D72H24D	3056	3264	72.81	73.24	24	24	295	26

**L2TW3H2D-D • Storage Tower With a 2-High Cupboard Over a 3-High Lateral Unit**

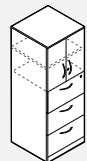

- Two locks included.
- Optional e-lock available in the vertical position for the file drawers. Please specify V - Vertical and add \$304 list.
- Optional e-lock available in the horizontal position for the upper storage cabinet. Please specify HR - Horizontal Right and add \$304 list.

PRODUCT CODE	FINISH		SIZE/INCHES				WEIGHT LBS	VOL FT <sup>3</sup>
	LP	W	H(LP/B)	H(W)	W	D		
L2TW3H2D66H20D	3150	3287	65.81	66.25	24	20	296	24
L2TW3H2D72H20D	3244	3344	72.81	73.24	24	20	311	26
L2TW3H2D66H24D	3274	3418	65.81	66.25	24	24	296	24
L2TW3H2D72H24D	3372	3477	72.81	73.24	24	24	311	26

**L2TW4H2D-D • Tower With a 2-Door Storage Cabinet Over a 4-High Lateral Unit**

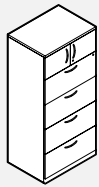

- Two locks included.
- Lock on cupboard is not available for UB, UC or RN handles.
- Optional e-lock available in the vertical position for the file drawers. Please specify V - Vertical and add \$304 list.
- Optional e-lock available in the horizontal position for the upper storage cabinet . Please specify HR - Horizontal Right and add \$304 list.

PRODUCT CODE	FINISH LP	W	SIZE/INCHES				WEIGHT LBS	VOL FT <sup>3</sup>
			H (LP/B)	H (W)	W	D		
L2TW4H2D66H20D	3575	3717	65.81	66.25	24	20	307	24
L2TW4H2D72H20D	3690	3734	72.81	73.24	24	20	322	26
L2TW4H2D66H24D	3718	3864	65.81	66.25	24	24	307	24
L2TW4H2D72H24D	3771	3882	72.81	73.24	24	24	322	26

**L2TWBBF2DL • Storage Tower With a 3-High Cupboard, Box/Box/File Drawers and Wardrobe**

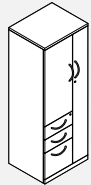

Right Hand Shown

- Storage compartment includes 1 adjustable shelves for 50" h unit and 2 adjustable shelves for 66" h and 72" h units
- Two locks included.
- Optional e-lock available in the vertical position for the box, box, file drawers. Please specify V - Vertical and add \$304 list.
- Optional e-lock available in the horizontal position for the wardrobe. Please specify HR - Horizontal Right or HL - Horizontal Left and add \$304 list.

PRODUCT CODE	FINISH LP	W	SIZE/INCHES				WEIGHT LBS	VOL FT <sup>3</sup>
			H (LP/B)	H (W)	W	D		
<b>Left</b>								
L2TWBBF2DL50H20D	2666	2866	49.56	50.00	24	20	288	20
L2TWBBF2DL66H20D	2969	3107	65.81	66.25	24	20	348	22
L2TWBBF2DL72H20D	3078	3215	72.81	73.25	24	20	378	24
L2TWBBF2DL50H24D	2774	2980	49.5	50.00	24	24	288	20
L2TWBBF2DL66H24D	3087	3231	65.81	66.25	24	24	348	22
L2TWBBF2DL72H24D	3201	3344	72.81	73.25	24	24	378	24
<b>Right</b>								
L2TWBBF2DR50H20D	2666	2866	49.56	50.00	24	20	288	20
L2TWBBF2DR66H20D	2969	3107	65.81	66.25	24	20	348	22
L2TWBBF2DR72H20D	3078	3215	72.81	73.25	24	20	378	24
L2TWBBF2DR50H24D	2774	2980	49.5	50.00	24	24	288	20
L2TWBBF2DR66H24D	3087	3231	65.81	66.25	24	24	348	22
L2TWBBF2DR72H24D	3201	3344	72.81	73.25	24	24	378	24

**L2TW2F2D-D • Storage Tower With a 3-High Cupboard, File/File Drawers and Wardrobe**

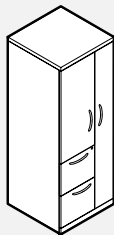

Right Hand Shown

- Wardrobe has a coat rod.
- Two locks included.
- Optional e-lock available in the vertical position for the file drawers. Please specify V - Vertical and add \$304 list.
- Optional e-lock available in the horizontal position for the wardrobe. Please specify HR - Horizontal Right or HL - Horizontal Left and add \$304 list.

PRODUCT CODE	FINISH LP	W	SIZE/INCHES				WEIGHT LBS	VOL FT <sup>3</sup>
			H (LP/B)	H (W)	W	D		
<b>Left</b>								
L2TW2F2DL50H20D	2471	2666	49.56	50.00	24	20	222	22
L2TW2F2DL66H20D	2769	2904	65.81	66.25	24	20	279	24
L2TW2F2DL72H20D	2876	3010	72.81	73.24	24	20	295	26
L2TW2F2DL50H24D	2569	2773	49.56	50.00	24	24	222	22
L2TW2F2DL66H24D	2878	3022	65.81	66.25	24	24	279	24
L2TW2F2DL72H24D	2991	3131	72.81	73.24	24	24	295	26
<b>Right</b>								
L2TW2F2DR50H20D	2471	2666	49.56	50.00	24	20	222	22
L2TW2F2DR66H20D	2769	2904	65.81	66.25	24	20	279	24
L2TW2F2DR72H20D	2876	3010	72.81	73.24	24	20	295	26
L2TW2F2DR50H24D	2569	2773	49.56	50.00	24	24	222	22
L2TW2F2DR66H24D	2878	3022	65.81	66.25	24	24	279	24
L2TW2F2DR72H24D	2991	3131	72.81	73.24	24	24	295	26

**L2TW3F2D-D • Storage Tower With a 2-High Cupboard, File/File/File Drawers and Wardrobe**

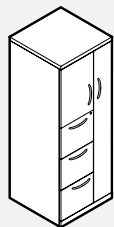

Right Hand Shown

- Two locks included.
- Optional e-lock available in the vertical position for the file drawers. Please specify V - Vertical and add \$304 list.
- Optional e-lock available in the horizontal position for the wardrobe. Please specify HR - Horizontal Right or HL - Horizontal Left and add \$304 list.

PRODUCT CODE	FINISH LP	W	SIZE/INCHES				WEIGHT LBS	VOL FT <sup>3</sup>
			H (LP/B)	H (W)	W	D		
<b>Left</b>								
L2TW3F2DL66H20D	2927	3075	65.81	66.25	24	20	296	24
L2TW3F2DL72H20D	3037	3152	72.81	73.24	24	20	311	26
L2TW3F2DL66H24D	3045	3199	65.81	66.25	24	24	296	24
L2TW3F2DL72H24D	3158	3276	72.81	73.24	24	24	311	26
<b>Right</b>								
L2TW3F2DR66H20D	2927	3075	65.81	66.25	24	20	296	24
L2TW3F2DR72H20D	3037	3152	72.81	73.24	24	20	311	26
L2TW3F2DR66H24D	3045	3199	65.81	66.25	24	24	296	24
L2TW3F2DR72H24D	3158	3276	72.81	73.24	24	24	311	26

**L2TWBBFDO • Storage Tower With 3-High Side-Open Cupboard, Box/Box/File Drawers and Wardrobe**

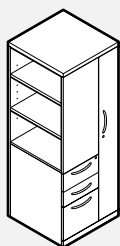

Right Hand Shown

- Open bookcase compartment includes 1 adjustable shelves for 50" unit and 2 adjustable shelves for 66" and 72" units
- Two locks included.
- Optional e-lock available in the vertical position for the box, box, file drawers. Please specify V - Vertical and add \$304 list.
- Optional e-lock available in the horizontal position for the wardrobe. Please specify HR - Horizontal Right or HL - Horizontal Left and add \$304 list.

PRODUCT CODE	FINISH LP	FINISH W	SIZE/INCHES				WEIGHT LBS	VOL FT <sup>3</sup>
			H (LP/B)	H (W)	W	D		
<b>Left</b>								
L2TWBBFDOL50H20D	2481	2635	49.50	50.00	24	20	285	20
L2TWBBFDOL66H20D	2742	2833	65.81	66.25	24	20	345	22
L2TWBBFDOL72H20D	2834	2919	72.81	73.25	24	20	375	24
L2TWBBFDOL50H24D	2579	2740	49.50	50.00	24	24	285	20
L2TWBBFDOL66H24D	2853	2946	65.81	66.25	24	24	345	22
L2TWBBFDOL72H24D	2948	3035	72.81	73.25	24	24	375	24
<b>Right</b>								
L2TWBBFDOR50H20D	2481	2635	49.50	50.00	24	20	285	20
L2TWBBFDOR66H20D	2742	2833	65.81	66.25	24	20	345	22
L2TWBBFDOR72H20D	2834	2919	72.81	73.25	24	20	375	24
L2TWBBFDOR50H24D	2579	2740	49.50	50.00	24	24	285	20
L2TWBBFDOR66H24D	2853	2946	65.81	66.25	24	24	345	22
L2TWBBFDOR72H24D	2948	3035	72.81	73.25	24	24	375	24

**L2TW2FDO-D • Storage Tower With a 3-High Side-Open Cupboard, File/File Drawers and Wardrobe**

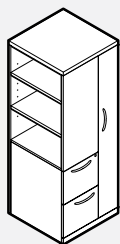

Right Hand Shown

- 50"-High Tower comes with one adjustable shelf.
- Two locks included.
- Optional e-lock available in the vertical position for the file drawers. Please specify V - Vertical and add \$304 list.
- Optional e-lock available in the horizontal position for the wardrobe. Please specify HR - Horizontal Right or HL - Horizontal Left and add \$304 list.

PRODUCT CODE	FINISH LP	FINISH W	SIZE/INCHES				WEIGHT LBS	VOL FT <sup>3</sup>
			H (LP/B)	H (W)	W	D		
<b>Left</b>								
L2TW2FDOL50H20D	2288	2440	49.56	50.00	24	20	211	22
L2TW2FDOL66H20D	2548	2635	65.81	66.25	24	20	268	24
L2TW2FDOL72H20D	2637	2720	72.81	73.24	24	20	284	26
L2TW2FDOL50H24D	2384	2536	49.56	50.00	24	24	211	22
L2TW2FDOL66H24D	2649	2738	65.81	66.25	24	24	268	24
L2TW2FDOL72H24D	2740	2829	72.81	73.24	24	24	284	26
<b>Right</b>								
L2TW2FDOR50H20D	2288	2440	49.56	50.00	24	20	211	22
L2TW2FDOR66H20D	2548	2635	65.81	66.25	24	20	268	24
L2TW2FDOR72H20D	2637	2720	72.81	73.24	24	20	284	26
L2TW2FDOR50H24D	2384	2536	49.56	50.00	24	24	211	22
L2TW2FDOR66H24D	2649	2738	65.81	66.25	24	24	268	24
L2TW2FDOR72H24D	2741	2829	72.81	73.24	24	24	284	26

**L2TW3FDO-D • Storage Tower With a 2-High Side-Open Cupboard, File/File/File Drawers and Wardrobe**

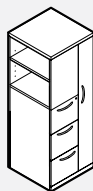

Right Hand Shown

- Two locks included.
- Optional e-lock available in the vertical position for the file drawers. Please specify V - Vertical and add \$304 list.
- Optional e-lock available in the horizontal position for the wardrobe. Please specify HR - Horizontal Right or HL - Horizontal Left and add \$304 list.

PRODUCT CODE	FINISH LP	FINISH W	SIZE/INCHES				WEIGHT LBS	VOL FT <sup>3</sup>
			H (LP/B)	H (W)	W	D		
<b>Left</b>								
L2TW3FDOL66H20D	2751	2942	65.81	66.25	24	20	285	24
L2TW3FDOL72H20D	2921	2943	72.81	73.24	24	20	300	26
L2TW3FDOL66H24D	2860	3061	65.81	66.25	24	24	285	24
L2TW3FDOL72H24D	3038	3058	72.81	73.24	24	24	300	26
<b>Right</b>								
L2TW3FDOR66H20D	2751	2942	65.81	66.25	24	20	285	24
L2TW3FDOR72H20D	2921	2943	72.81	73.24	24	20	300	26
L2TW3FDOR66H24D	2860	3061	65.81	66.25	24	24	285	24
L2TW3FDOR72H24D	3038	3058	72.81	73.24	24	24	300	26

**L2TWA2DCS • Storage Tower With 2 Aluminum Doors, Coat Rod and Hat Shelf**

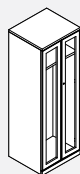

- 50"-High Tower comes with 1 shelf above hang rod.
- One lock included.
- E-locks not available for aluminum-framed glass doors.

PRODUCT CODE	FINISH LP	FINISH W	SIZE/INCHES				WEIGHT LBS	VOL FT <sup>3</sup>
			H (LP/B)	H (W)	W	D		
L2TWA2DCS50H20D	2783	2984	49.56	50.00	24	20	162	20
L2TWA2DCS66H20D	3247	3390	65.81	66.25	24	20	244	22
L2TWA2DCS72H20D	3418	3563	72.81	73.25	24	20	258	24
L2TWA2DCS50H24D	2851	3054	49.56	50.00	24	24	162	20
L2TWA2DCS66H24D	3323	3470	65.81	66.25	24	24	244	22
L2TWA2DCS72H24D	3499	3643	72.81	73.25	24	24	258	24

**L2TWA2D • Storage Tower With 2 Aluminum Doors and 4 Adjustable Shelves**

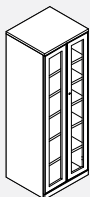

- 50"-High Tower comes with 3 adjustable shelves.
- One lock included.
- E-locks not available for aluminum-framed glass doors.

PRODUCT CODE	FINISH LP	FINISH W	SIZE/INCHES				WEIGHT LBS	VOL FT <sup>3</sup>
			H (LP/B)	H (W)	W	D		
L2TWA2D50H20D	2988	3127	49.56	50.00	24	20	192	20
L2TWA2D66H20D	3427	3618	65.81	66.25	24	20	244	22
L2TWA2D72H20D	3609	3790	72.81	73.25	24	20	257	24
L2TWA2D50H24D	3062	3207	49.56	50.00	24	24	192	20
L2TWA2D66H24D	3510	3707	65.81	66.25	24	24	244	22
L2TWA2D72H24D	3695	3882	72.81	73.25	24	24	257	24



**L2TWA2H2D • Storage Tower With a 3-High Cupboard Over a 2-High Lateral Unit**

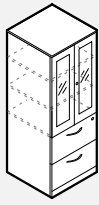

- 50"-High Tower comes with 1 adjustable shelf.
- Lock is on the upper drawer.
- Two locks included.
- Optional e-lock available in the vertical position. Please specify V - Vertical and add \$304 list.
- E-locks not available for aluminum-framed glass doors.

PRODUCT CODE	FINISH		SIZE/INCHES				WEIGHT LBS	VOL FT <sup>3</sup>
	LP	W	H (LP/B)	H (W)	W	D		
L2TWA2H2D50H20D	3258	3312	49.56	50.00	24	20	202	20
L2TWA2H2D66H20D	3783	3828	65.81	66.25	24	20	254	22
L2TWA2H2D72H20D	3955	4160	72.81	73.25	24	20	258	24
L2TWA2H2D50H24D	3363	3420	49.56	50.00	24	24	202	20
L2TWA2H2D66H24D	3901	3947	65.81	66.25	24	24	254	22
L2TWA2H2D72H24D	4075	4285	72.81	73.25	24	24	258	24

**L2TWA3H2D • Storage Tower With a 2-High Cupboard With Aluminum Doors Over a 3-High Lateral Unit**

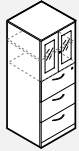

- Lock is on the upper drawer.
- Two locks included.
- Optional e-lock available in the vertical position. Please specify V - Vertical and add \$304 list.
- E-locks not available for aluminum-framed glass doors.

PRODUCT CODE	FINISH		SIZE/INCHES				WEIGHT LBS	VOL FT <sup>3</sup>
	LP	W	H (LP/B)	H (W)	W	D		
L2TWA3H2D66H20D	3892	4033	65.81	66.25	24	20	269	22
L2TWA3H2D72H20D	4076	4178	72.81	73.25	24	20	283	24
L2TWA3H2D66H24D	4020	4165	65.81	66.25	24	24	269	22
L2TWA3H2D72H24D	4208	4314	72.81	73.25	24	24	283	24

**L2TWA4H2D • Storage Tower With Cupboard With Aluminum Doors Over a 4-High Lateral Unit**

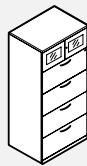

- Lock is on the upper drawer.
- Two locks included.
- Optional e-lock available in the vertical position. Please specify V - Vertical and add \$304 list.
- E-locks not available for aluminum-framed glass doors.

PRODUCT CODE	FINISH		SIZE/INCHES				WEIGHT LBS	VOL FT <sup>3</sup>
	LP	W	H (LP/B)	H (W)	W	D		
L2TWA4H2D66H20D	4068	4211	65.81	66.25	24	20	279	22
L2TWA4H2D72H20D	4285	4332	72.81	73.25	24	20	293	24
L2TWA4H2D66H24D	4213	4360	65.81	66.25	24	24	293	22
L2TWA4H2D72H24D	4436	4483	72.81	73.25	24	24	293	24

**L2TWA2F2D • Storage Tower With a 3-High Cupboard, File/File Drawers and Wardrobe**

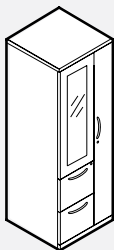

Right Hand Shown

- Storage compartment includes 1 adjustable shelves for 50"h unit and 2 adjustable shelves for 66"h and 72"h units
- Two locks included.
- Optional e-lock available in the vertical position for the file drawers. Please specify V - Vertical and add \$304 list.
- Optional e-lock available in the horizontal position for the wardrobe. Please specify HR - Horizontal Right or HL - Horizontal Left and add \$304 list.
- E-locks not available for aluminum-framed glass doors.

PRODUCT CODE	FINISH		SIZE/INCHES				WEIGHT LBS	VOL FT <sup>3</sup>
	LP	W	H (LP/B)	H (W)	W	D		
L2TWA2F2DR50H20D	2834	3034	49.56	50.00	24	20	219	20
L2TWA2F2DR66H20D	3278	3415	65.81	66.25	24	20	276	22
L2TWA2F2DR72H20D	3438	3575	72.81	73.25	24	20	292	24
L2TWA2F2DR50H24D	2936	3142	49.56	50.00	24	24	219	20
L2TWA2F2DR66H24D	3391	3531	65.81	66.25	24	24	276	22
L2TWA2F2DR72H24D	3556	3698	72.81	73.25	24	24	292	24
L2TWA2F2DL50H20D	2834	3034	49.56	50.00	24	20	219	20
L2TWA2F2DL66H20D	3278	3415	65.81	66.25	24	20	276	22
L2TWA2F2DL72H20D	3438	3575	72.81	73.25	24	20	292	24
L2TWA2F2DL50H24D	2936	3142	49.56	50.00	24	24	219	20
L2TWA2F2DL66H24D	3391	3531	65.81	66.25	24	24	276	22
L2TWA2F2DL72H24D	3556	3698	72.81	73.25	24	24	292	24

**L2TWABBF2D • Storage Tower With a 3-High Cupboard, Box/Box/File Drawers and Wardrobe**

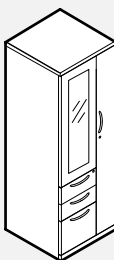

Right Hand Shown

- Storage compartment includes 1 adjustable shelves for 50"h unit and 2 adjustable shelves for 66"h and 72"h units
- Two locks included.
- Optional e-lock available in the vertical position for the box, box, file drawers. Please specify V - Vertical and add \$304 list.
- Optional e-lock available in the horizontal position for the wardrobe. Please specify HR - Horizontal Right or HL - Horizontal Left and add \$304 list.
- E-locks not available for aluminum-framed glass doors.

PRODUCT CODE	FINISH		SIZE/INCHES				WEIGHT LBS	VOL FT <sup>3</sup>
	LP	W	H (LP/B)	H (W)	W	D		
L2TWABBF2DL50H20D	2995	3195	49.56	50.00	24	20	288	20
L2TWABBF2DL66H20D	3438	3574	65.81	66.25	24	20	348	22
L2TWABBF2DL72H20D	3598	3736	72.81	73.25	24	20	378	24
L2TWABBF2DL50H24D	3094	3302	49.56	50.00	24	24	288	20
L2TWABBF2DL66H24D	3552	3692	65.81	66.25	24	24	348	22
L2TWABBF2DL72H24D	3717	3859	72.81	73.25	24	24	378	24
L2TWABBF2DR50H20D	2995	3195	49.56	50.00	24	20	288	20
L2TWABBF2DR66H20D	3438	3574	65.81	66.25	24	20	348	22
L2TWABBF2DR72H20D	3598	3736	72.81	73.25	24	20	378	24
L2TWABBF2DR50H24D	3094	3302	49.56	50.00	24	24	288	20
L2TWABBF2DR66H24D	3552	3692	65.81	66.25	24	24	348	22
L2TWABBF2DR72H24D	3717	3859	72.81	73.25	24	24	378	24

**L2TW3F2D-D • Storage Tower With a 2-High Cupboard, File/File/File Drawers and Wardrobe**

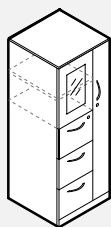

- Lock is on the upper drawer.
- Storage compartment includes 1 adjustable shelf.
- Two locks included.
- Optional e-lock available in the vertical position for the file drawers. Please specify V - Vertical and add \$304 list.
- Optional e-lock available in the horizontal position for the wardrobe. Please specify HR - Horizontal Right or HL - Horizontal Left and add \$304 list.
- E-locks not available for aluminum-framed glass doors.

PRODUCT CODE	FINISH		SIZE/INCHES				WEIGHT		VOL FT <sup>3</sup>
	LP	W	H (LP/B)	H (W)	W	D	LBS		
L2TWA3F2DR66H20D	3358	3504	65.81	66.25	24	20	340	22	
L2TWA3F2DR72H20D	3514	3654	72.81	73.25	24	20	370	24	
L2TWA3F2DR66H24D	3479	3631	65.81	66.25	24	24	340	22	
L2TWA3F2DR72H24D	3638	3758	72.81	73.25	24	24	370	24	
L2TWA3F2DL66H20D	3358	3504	65.81	66.25	24	20	340	22	
L2TWA3F2DL72H20D	3514	3631	72.81	73.25	24	20	370	24	
L2TWA3F2DL66H24D	3479	3654	65.81	66.25	24	24	340	22	
L2TWA3F2DL72H24D	3638	3758	72.81	73.25	24	24	370	24	

**L2CB • Storage Cabinet With 2 Doors and 4 Adjustable Shelves**

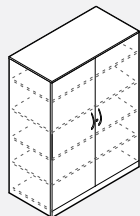

- 50"h. cabinet comes with 3 adjustable shelves.
- 66"h. and 72"h. Cabinet comes with 4 adjustable shelves.
- One lock included.
- Optional e-lock available in the horizontal position. Please specify HR - Horizontal Right and add \$304 list.

PRODUCT CODE	FINISH		SIZE/INCHES				WEIGHT		VOL FT <sup>3</sup>
	LP	W	H (LP/B)	H (W)	W	D	LBS		
L2CB20302D50H	2163	2341	49.56	50.00	30	20	245	21	
L2CB20362D50H	2315	2522	49.56	50.00	36	20	281	25	
L2CB20302D66H	2456	2630	65.81	66.25	30	20	310	28	
L2CB20362D66H	2640	2840	65.81	66.25	36	20	354	33	
L2CB20302D72H	2553	2724	72.81	73.24	30	20	327	30	
L2CB20362D72H	2738	2938	72.81	73.24	36	20	372	36	
L2CB24302D50H	2249	2434	49.56	50.00	30	24	245	25	
L2CB24362D50H	2407	2621	49.56	50.00	36	24	281	30	
L2CB24302D66H	2557	2735	65.81	66.25	30	24	310	33	
L2CB24362D66H	2746	2954	65.81	66.25	36	24	354	39	
L2CB24302D72H	2655	2833	72.81	73.24	30	24	327	36	
L2CB24362D72H	2850	3056	72.81	73.24	36	24	372	43	

**L2CB • Storage Cabinet With 2 Doors, Coat Rod and 1 Fixed Shelf**

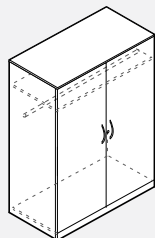

- One lock included.
- Optional e-lock available in the horizontal position. Please specify HR - Horizontal Right and add \$304 list.

PRODUCT CODE	FINISH		SIZE/INCHES				WEIGHT		VOL FT <sup>3</sup>
	LP	W	H (LP/B)	H (W)	W	D	LBS		
L2CB20302DCS50H	1977	2141	49.56	50.00	30	20	204	21	
L2CB20362DCS50H	2088	2287	49.56	50.00	36	20	231	25	
L2CB20302DCS66H	2168	2374	65.81	66.25	30	20	249	28	
L2CB20362DCS66H	2283	2483	65.81	66.25	36	20	281	33	
L2CB20302DCS72H	2262	2600	72.81	73.24	30	20	265	30	
L2CB20362DCS72H	2386	2586	72.81	73.24	36	20	298	36	
L2CB24302DCS50H	2056	2228	49.56	50.00	30	24	204	25	
L2CB24362DCS50H	2171	2378	49.56	50.00	36	24	231	30	
L2CB24302DCS66H	2254	2471	65.81	66.25	30	24	249	33	
L2CB24362DCS66H	2373	2579	65.81	66.25	36	24	281	39	
L2CB24302DCS72H	2354	2702	72.81	73.24	30	24	265	36	
L2CB24362DCS72H	2481	2689	72.81	73.24	36	24	298	43	

**L2CB • Storage Cabinet With 3-High Cupboard, 2 Adjustable Shelves Over a 2-High Lateral Unit**

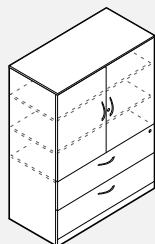

- 50"h. cabinet comes with one adjustable shelf.
- 66" and 72" Cabinet comes with 2 adjustable shelves.
- Two locks included.
- Optional e-lock available for the file drawers vertical position. Please specify V - Vertical and add \$304 list.
- Optional e-lock available in the horizontal position for upper storage cabinet. Please specify HR - Horizontal Right and add \$304 list.

PRODUCT CODE	FINISH		SIZE/INCHES				WEIGHT		VOL FT <sup>3</sup>
	LP	W	H (LP/B)	H (W)	W	D	LBS		
L2CB20302H2D50H	2811	2967	49.56	50.00	30	20	256	21	
L2CB20362H2D50H	2988	3129	49.56	50.00	36	20	292	25	
L2CB20302H2D66H	3146	3305	65.81	66.25	30	20	321	28	
L2CB20362H2D66H	3352	3488	65.81	66.25	36	20	365	33	
L2CB20302H2D72H	3245	3405	72.81	73.24	30	20	338	30	
L2CB20362H2D72H	3422	3584	72.81	73.24	36	20	383	36	
L2CB24302H2D50H	2921	3086	49.56	50.00	30	24	256	25	
L2CB24362H2D50H	3108	3253	49.56	50.00	36	24	292	30	
L2CB24302H2D66H	3272	3438	65.81	66.25	30	24	321	33	
L2CB24362H2D66H	3485	3631	65.81	66.25	36	24	365	39	
L2CB24302H2D72H	3377	3540	72.81	73.24	30	24	338	36	
L2CB24362H2D72H	3558	3728	72.81	73.24	36	24	383	43	

**L2CB • Storage Cabinet With a 2-High Cupboard, 1 Adjustable Shelf Over a 3-High Lateral Unit**

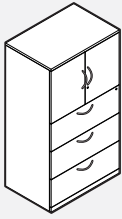

- One lock on right door.
- Two locks included.
- Optional e-lock available for the file drawers vertical position. Please specify V - Vertical and add \$304 list.
- Optional e-lock available in the horizontal position for upper storage cabinet. Please specify HR - Horizontal Right and add \$304 list.

PRODUCT CODE	FINISH LP	W	SIZE/INCHES			D	WEIGHT LBS	VOL FT <sup>3</sup>
			H (LP/B)	H (W)	W			
L2CB20303H2D66H	3345	3508	65.81	66.25	30	20	337	28
L2CB20363H2D66H	3556	3749	65.81	66.25	36	20	381	33
L2CB20303H2D72H	3479	3641	72.81	73.25	30	20	354	30
L2CB20363H2D72H	3686	3884	72.81	73.25	36	20	399	36
L2CB24303H2D66H	3480	3649	65.81	66.25	30	24	337	28
L2CB24363H2D66H	3698	3900	65.81	66.25	36	24	381	33
L2CB24303H2D72H	3617	3787	72.81	73.25	30	24	354	30
L2CB24363H2D72H	3834	4041	72.81	73.25	36	24	399	36

**L2CB • Storage Cabinet With a 2-Door Storage Cupboard above a 4-High Lateral Unit**

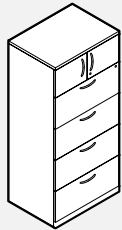

- Two locks included.
- Lock on cupboard is not available for UB, UC or RN handles.
- Optional e-lock available for the file drawers vertical position. Please specify V - Vertical and add \$304 list.
- Optional e-lock available in the horizontal position for upper storage cabinet. Please specify HR - Horizontal Right and add \$304 list.

PRODUCT CODE	FINISH LP	W	SIZE/INCHES			D	WEIGHT LBS	VOL FT <sup>3</sup>
			H (LP/B)	H (W)	W			
L2CB20304H2D66H	3795	3992	65.81	66.25	30	20	343	28
L2CB20364H2D66H	4095	4294	65.81	66.25	36	20	387	33
L2CB20304H2D72H	3896	4064	72.81	73.24	30	20	360	30
L2CB20364H2D72H	4135	4334	72.81	73.24	36	20	405	36
L2CB24304H2D66H	3950	4152	65.81	66.25	30	24	278	33
L2CB24364H2D66H	4259	4467	65.81	66.25	36	24	314	39
L2CB24304H2D72H	4052	4226	72.81	73.24	30	24	343	36
L2CB24364H2D72H	4301	4507	72.81	73.24	36	24	387	43

**L2CB • Storage Cabinet With Open Bookcase and 2 Adjustable Shelves and 2-Door Cupboard**

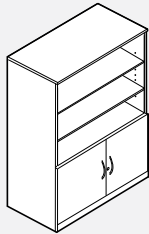

- 50" h cabinet comes with one adjustable shelf.
- 66" h and 72" h. Cabinet comes with 2 adjustable Shelves.
- One lock included.
- Optional e-lock available in the horizontal position. Please specify HR - Horizontal Right and add \$304 list.

PRODUCT CODE	FINISH LP	W	SIZE/INCHES			D	WEIGHT LBS	VOL FT <sup>3</sup>
			H (LP/B)	H (W)	W			
L2CB20302D050H	1814	2056	49.56	50.00	30	20	212	21
L2CB20362D050H	1938	2276	49.56	50.00	36	20	248	25
L2CB20302D066H	2035	2342	65.81	66.25	30	20	277	28
L2CB20362D066H	2498	2656	65.81	66.25	36	20	321	33
L2CB20302D072H	2103	2436	72.81	73.24	30	20	294	30
L2CB20362D072H	2294	2754	72.81	73.24	36	20	339	36
L2CB24302D050H	1905	2158	49.56	50.00	30	24	212	25
L2CB24362D050H	2035	2391	49.56	50.00	36	24	248	30
L2CB24302D066H	2137	2460	65.81	66.25	30	24	277	33
L2CB24362D066H	2306	2789	65.81	66.25	36	24	321	39
L2CB24302D072H	2207	2557	72.81	73.24	30	24	294	36
L2CB24362D072H	2407	2893	72.81	73.24	36	24	339	43

**L2CB • Storage Cabinet With Open Bookcase and 2 Adjustable Shelves Over a 2-High Lateral Unit**

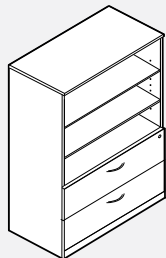

- 50" h cabinet comes with one adjustable shelf.
- 66" h and 72" h. Cabinet comes with 2 adjustable Shelves.
- One lock included.
- Optional e-lock available in the vertical position. Please specify V - Vertical and add \$304 list.

PRODUCT CODE	FINISH LP	W	SIZE/INCHES			D	WEIGHT LBS	VOL FT <sup>3</sup>
			H (LP/B)	H (W)	W			
L2CB20302H050H	2191	2351	49.56	50.00	30	20	226	21
L2CB20362H050H	2300	2471	49.56	50.00	36	20	261	25
L2CB20302H066H	2414	2573	65.81	66.25	30	20	290	28
L2CB20362H066H	2610	2714	65.81	66.25	36	20	334	33
L2CB20302H072H	2509	2554	72.81	73.24	30	20	307	30
L2CB20362H072H	2677	2779	72.81	73.24	36	20	352	36
L2CB24302H050H	2299	2470	49.56	50.00	30	24	226	25
L2CB24362H050H	2414	2596	49.56	50.00	36	24	261	30
L2CB24302H066H	2533	2702	65.81	66.25	30	24	290	33
L2CB24362H066H	2738	2848	65.81	66.25	36	24	334	39
L2CB24302H072H	2632	2682	72.81	73.24	30	24	307	36
L2CB24362H072H	2811	2918	72.81	73.24	36	24	352	43

**L2CBA • Storage Cabinet With 2 Doors and 4 Adjustable Shelves**

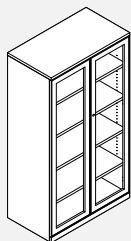

- One lock included.
- Door frame is anodized aluminum.
- Glazing is frosted acrylic.
- Doors standard with no handles.
- E-locks not available for aluminum-framed glass doors.

PRODUCT CODE	FINISH LP	W	SIZE / INCHES				WEIGHT		VOL FT <sup>3</sup>
			H (LP/B)	H (W)	W	D	LBS		
L2CBA20302D50H	3379	3560	49.56	50.00	30	20	235	21	
L2CBA20362D50H	3660	3871	49.56	50.00	36	20	281	25	
L2CBA20302D66H	3947	4123	65.81	66.25	30	20	300	28	
L2CBA20362D66H	4295	4500	65.81	66.25	36	20	344	33	
L2CBA20302D72H	4147	4322	72.81	73.25	30	20	317	30	
L2CBA20362D72H	4508	4712	72.81	73.25	36	20	362	36	
L2CBA24302D50H	3467	3655	49.56	50.00	30	24	235	21	
L2CBA24362D50H	3753	3969	49.56	50.00	36	24	281	25	
L2CBA24302D66H	4048	4230	65.81	66.25	30	24	300	28	
L2CBA24362D66H	4399	4611	65.81	66.25	36	24	344	33	
L2CBA24302D72H	4252	4431	72.81	73.25	30	24	317	30	
L2CBA24362D72H	4621	4832	72.81	73.25	36	24	362	36	

**L2CBA • Storage Cabinet With 2 Doors, Coat Rod and 1 Adjustable Shelf**

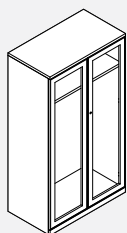

- One lock included.
- Door frame is anodized aluminum.
- Glazing is frosted acrylic.
- Doors standard with no handles.
- E-locks not available for aluminum-framed glass doors.

PRODUCT CODE	FINISH LP	W	SIZE / INCHES				WEIGHT		VOL FT <sup>3</sup>
			H (LP/B)	H (W)	W	D	LBS		
L2CBA20302DCS50H	3195	3359	49.56	50.00	30	20	195	21	
L2CBA20362DCS50H	3427	3631	49.56	50.00	36	20	221	25	
L2CBA20302DCS66H	3654	3864	65.81	66.25	30	20	239	28	
L2CBA20362DCS66H	3931	4134	65.81	66.25	36	20	271	33	
L2CBA20302DCS72H	3854	4197	72.81	73.25	30	20	255	30	
L2CBA20362DCS72H	4152	4352	72.81	73.25	36	20	288	36	
L2CBA24302DCS50H	3274	3448	49.56	50.00	30	24	195	21	
L2CBA24362DCS50H	3512	3723	49.56	50.00	36	24	221	25	
L2CBA24302DCS66H	3742	3962	65.81	66.25	30	24	239	28	
L2CBA24362DCS66H	4022	4232	65.81	66.25	36	24	271	33	
L2CBA24302DCS72H	3947	4300	72.81	73.25	30	24	255	30	
L2CBA24362DCS72H	4248	4460	72.81	73.25	36	24	288	36	

**L2CBA • Storage Cabinet With 3-High Cupboard, 2 Adjustable Shelves Over a 2-High Lateral Unit**

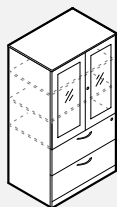

- Cabinet 2h2d.
- One lock on right door.
- One lock on upper drawer.
- Door frame is anodized aluminum with lock(s).
- Glazing is frosted acrylic.
- Doors standard with no handles.
- Two locks included.
- Optional e-lock available in the vertical position. Please specify V-Vertical and add \$304 list.
- E-locks not available for aluminum-framed glass doors.

PRODUCT CODE	FINISH LP	W	SIZE / INCHES				WEIGHT		VOL FT <sup>3</sup>
			H (LP/B)	H (W)	W	D	LBS		
L2CBA20302H2D50H	3568	3728	49.56	50.00	30	20	233	19	
L2CBA20362H2D50H	3810	3956	49.56	50.00	36	20	265	22	
L2CBA20302H2D66H	4176	4339	65.81	66.25	30	20	292	25	
L2CBA20362H2D66H	4484	4674	65.81	66.25	36	20	332	29	
L2CBA20302H2D72H	4377	4540	72.81	73.25	30	20	307	27	
L2CBA20362H2D72H	4669	4832	72.81	73.25	36	20	348	32	
L2CBA24302H2D50H	3682	3847	49.56	50.00	30	24	233	22	
L2CBA24362H2D50H	3933	4082	49.56	50.00	36	24	265	27	
L2CBA24302H2D66H	4305	4473	65.81	66.25	30	24	292	29	
L2CBA24362H2D66H	4621	4819	65.81	66.25	36	24	332	35	
L2CBA24302H2D72H	4508	4676	72.81	73.25	30	24	307	32	
L2CBA24362H2D72H	4808	4980	72.81	73.25	36	24	348	38	

**L2CBA • Storage Cabinet With 2-High Cupboard, 1 Adjustable Shelf Over a 3-High Lateral Unit**

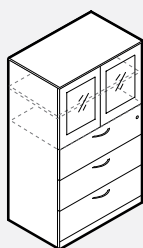

- Cabinet 3h2d.
- One lock on right door.
- One lock on upper drawer.
- Door frame is anodized aluminum with lock(s).
- Glazing is frosted acrylic.
- Doors standard with no handles.
- Two locks included.
- Optional e-lock available in the vertical position. Please specify V-Vertical and add \$304 list.
- E-locks not available for aluminum-framed glass doors.

PRODUCT CODE	FINISH LP	W	SIZE / INCHES				WEIGHT		VOL FT <sup>3</sup>
			H (LP/B)	H (W)	W	D	LBS		
L2CBA20303H2D66H	4117	4280	65.81	66.25	30	20	337	28	
L2CBA20363H2D66H	4398	4592	65.81	66.25	36	20	381	33	
L2CBA20303H2D72H	4351	4513	72.81	73.25	30	20	354	30	
L2CBA20363H2D72H	4643	4842	72.81	73.25	36	20	399	36	
L2CBA24303H2D66H	4252	4420	65.81	66.25	30	24	337	28	
L2CBA24363H2D66H	4541	4742	65.81	66.25	36	24	381	33	
L2CBA24303H2D72H	4489	4659	72.81	73.25	30	24	354	30	
L2CBA24363H2D72H	4792	4998	72.81	73.25	36	24	399	36	

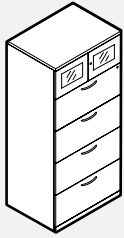
**L2CBA • Storage Cabinet With 2 Aluminum Door Storage Cupboard Above a 4-High Lateral Unit**

- Two locks included.
- Door frame is anodized aluminum.
- Glazing is frosted acrylic.
- Doors standard with no handles.
- One lock on right door.
- One lock on upper drawer.
- Optional e-lock available in the vertical position. Please specify V - Vertical and add \$304 list.
- E-locks not available for aluminum-framed glass doors.

PRODUCT CODE	FINISH LP	FINISH W	SIZE/INCHES			WEIGHT VOL		
			H (LP/B)	H (W)	W	D	LBS	FT <sup>3</sup>
L2CBA20304H2D66H	4381	4577	65.81	66.25	30	20	343	28
L2CBA20364H2D66H	4815	5018	65.81	66.25	36	20	387	33
L2CBA20304H2D72H	4593	4764	72.81	73.25	30	20	360	30
L2CBA20364H2D72H	4894	5093	72.81	73.25	36	20	345	36
L2CBA24304H2D66H	4535	4739	65.81	66.25	30	24	343	28
L2CBA24364H2D66H	4981	5192	65.81	66.25	36	24	387	33
L2CBA24304H2D72H	4751	4929	72.81	73.25	30	24	360	30
L2CBA24364H2D72H	5061	5269	72.81	73.25	36	24	345	36

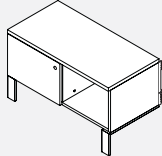
**L2BRTPSLSxx • Panel-Supporting Lateral Sliding Door**

- Fits below a 29" high table, can join with other 21" high, 18" and 23" deep storage units along the panel. Can serve as an additional worksurface or an ad-hoc guest seating with optional cushion.
- Storage compartment internal height: 12.36".
- Sliding door locks on left side.
- Anodized aluminum leg upcharge \$74.
- Optional e-lock available in the vertical position. Please specify V - Vertical and add \$304 list.

PRODUCT CODE	FINISH GROUP		SIZE/INCHES			WEIGHT VOL	
	LP	HP	H	W	D	LBS	FT <sup>3</sup>
L2BRTPSLS30	1367	1456	1186	30	19	53	6.56
L2BRTPSLS36	1477	1567	1277	36	19	60	7.87
L2BRTPSLS42	1590	1678	1367	42	19	67	9.18
L2BRTPSLS2330	1821	1941	1581	30	24	61	8.39
L2BRTPSLS2336	1970	2088	1701	36	24	70	10.06
L2BRTPSLS2342	2119	2239	1824	42	24	79	11.74

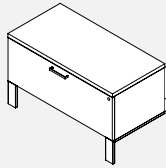
**L2BRTPSLxx • Panel-Supporting Lateral File Drawer**

- Fits below a 29" high table, can join with other 21" high, 18" and 23" deep storage units along the panel. Can serve as an additional worksurface or an ad-hoc guest seating with optional cushion.
- One file drawer (holds letter, legal and A4 suspended file folders).
- Anodized aluminum leg upcharge \$74.
- Optional e-lock available in the vertical position. Please specify V - Vertical and add \$304 list.

PRODUCT CODE	FINISH GROUP		SIZE/INCHES			WEIGHT VOL	
	LP	HP	H	W	D	LBS	FT <sup>3</sup>
L2BRTPSL30	1412	1432	1167	30	19	77	6.56
L2BRTPSL36	1544	1634	1331	36	19	84	7.87
L2BRTPSL42	1701	1790	1458	42	19	92	9.18
L2BRTPSL2330	1879	1910	1556	30	24	86	8.39
L2BRTPSL2336	2058	2179	1775	36	24	95	10.06
L2BRTPSL2342	2277	2387	1945	42	24	104	11.74

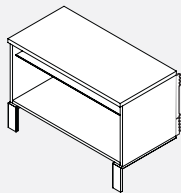
**L2BRTP25LOxxL • Panel-Supporting Open Storage**

- Fits below a 29" high table, can join with other 25" high, 18" and 23" deep storage units along the panel. Can serve as an additional worksurface or an ad-hoc guest seating with optional cushion.
- Open compartment with glass adjustable shelf. Storage compartment internal height without height-adjustable shelf: 15.8"
- Anodized aluminum leg upcharge \$74.

PRODUCT CODE	FINISH GROUP		SIZE/INCHES			WEIGHT VOL	
	LP	HP	H	W	D	LBS	FT <sup>3</sup>
L2BRTP25LO30L	783	939	765	30	19	49	7.81
L2BRTP25LO36L	984	1073	874	36	19	55	9.37
L2BRTP25LO42L	1073	1187	967	42	19	62	10.93
L2BRTP25LO2330L	1046	1253	1021	30	24	59	10.42
L2BRTP25LO2336L	1312	1432	1167	36	24	66	12.50
L2BRTP25LO2342L	1432	1581	1288	42	24	72	14.58

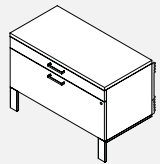
**L2BRTPPLBFxx • Panel-Supporting Lateral Box/File**

- Fits below a 29" high table, can join with other 25" high, 18" and 23" deep storage units along the panel.
- One lockable file drawer (holds letter, legal and A4 suspended file folders), one box drawer.
- Anodized aluminum leg upcharge \$74.
- Black injection moulded pencil tray included (can be secured inside the drawer anywhere along the perimeter wall).
- Optional e-lock available in the vertical position. Please specify V - Vertical and add \$304 list.

PRODUCT CODE	FINISH GROUP		SIZE/INCHES			WEIGHT VOL	
	LP	HP	H	W	D	LBS	FT <sup>3</sup>
L2BRTPPLBF30	1523	1613	1314	30	19	88	7.81
L2BRTPPLBF36	1745	1835	1495	36	19	96	9.37
L2BRTPPLBF42	1904	2014	1641	42	19	104	10.93
L2BRTPPLBF2330	2136	2239	1824	30	24	98	10.42
L2BRTPPLBF2336	2327	2445	1992	36	24	107	12.50
L2BRTPPLBF2342	2538	2686	2188	42	24	116	14.58

**L2BRT25L2Dxxxx • Panel-Supporting Lateral With Hinged Doors**

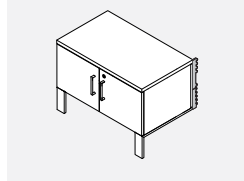

- Fits below a 29" high table, can join with other 25" high, 18" or 23" deep storage units along the panel.
- Can serve as an additional worksurface or an ad-hoc guest seating with optional cushion.
- Two lockable doors
- LP chassis and door fronts (specify LP finish)
- 1" top (specify LP or HP finish); metal handles, powder coated aluminum or anodized aluminum legs. Anodized aluminum leg upcharge \$74.

PRODUCT CODE	FINISH GROUP		SIZE/INCHES			WEIGHT		VOL FT <sup>3</sup>
	LP	HP	H	W	D	LBS		
L2BRT25L2D30	1208	1324	1079	30	19	69	7.81	
L2BRT25L2D36	1304	1442	1175	36	19	78	9.38	
L2BRT25L2D42	1369	1529	1246	42	19	90	10.94	
L2BRT25L2D3024	1382	1537	1252	30	24	75	10.42	
L2BRT25L2D3624	1499	1682	1370	36	24	84	12.50	
L2BRT25L2D4224	1610	1772	1444	42	24	96	14.58	

**L2BRT25BFxxL • 25" Box/File Pedestal**

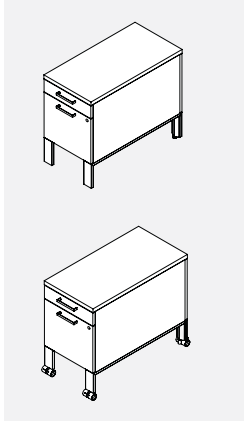

- Fits below a 29" high table.
- Can join with other 25" high storage units of corresponding depth to form a spine or slides out on casters to serve as an additional worksurface.
- Floor clearance allows for access to panel floor raceway duplex outlets; units on levelers accommodate installation of an optional Cable Basket to manage cords and data cables under storage spine.
- One box drawer, one file drawer (holds letter, legal and A4 suspended file folders except 18" pedestals).
- Optional Cable Basket suspends off storage unit's bottom and manages cables along the horizontal plane. (NO CASTER models only)
- Fits under 30" worksurface table beams as is.
- LP chassis and drawer fronts (specify LP finish) 1" top (specify LP or HP finish); metal handles, powder coated aluminum or anodized aluminum legs specify 5/16x2" levelers or 40mm white/grey, locking casters
- Anodized aluminum leg upcharge \$74.
- Pedestal with cushion will not fit under beam.
- Black injection moulded pencil tray included.
- Optional e-lock available in the vertical position. Please specify V - Vertical and add \$304 list.

PRODUCT CODE	FINISH GROUP		SIZE/INCHES			WEIGHT		VOL FT <sup>3</sup>
	LP	HP	H	W	D	LBS		
<b>Levelers</b>								
L2BRT25BF18L	1118	1187	967	15.5	18	69	3.89	
L2BRT25BF24L	1297	1366	1113	15.5	24	74	5.02	
L2BRT25BF30L	1410	1500	1222	15.5	30	82	6.15	
<b>Casters</b>								
L2BRT25BF18C	1208	1277	1040	15.5	18	69	3.89	
L2BRT25BF24C	1388	1456	1186	15.5	24	74	5.02	
L2BRT25BF30C	1500	1590	1295	15.5	30	82	6.15	

**L2BRTTW50xxL/R • Storage Tower With Coat Storage**

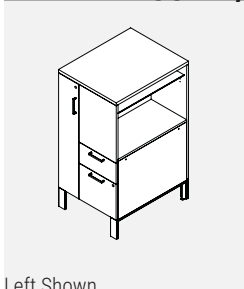

Left Shown

- Provides storage and privacy at the end of a table
- Box+file drawers; open compartment with adjustable shelf (50" high); coat storage with hinged door.
- Specify Left or Right handed.
- Capable of supporting worksurface on one side (built-in threaded inserts to secure dedicated worksurface-supporting beam).
- Open side storage compartment internal height: 19.6".
- Optional Cable Basket suspends off storage unit's bottom and manages cables along the horizontal plane.
- LP chassis (specify LP finish), 1" top (specify LP or HP finish); metal handles; powder coated aluminum or anodized aluminum legs (specify paint finish).
- Anodized aluminum leg upcharge \$74.
- Black injection moulded pencil tray included.
- Optional e-lock available in the vertical position for the box, file drawer. Please specify V - Vertical and add \$304 list.
- Optional e-lock available in the horizontal position for the wardrobe. Please specify HR - Horizontal Right or HL - Horizontal Left and add \$284 list.

PRODUCT CODE	FINISH GROUP		SIZE/INCHES			WEIGHT		VOL FT <sup>3</sup>
	LP	HP	H	W	D	LBS		
L2BRTTW5024L	2440	2596	2115	24	24	142	16.66	
L2BRTTW5024R	2440	2596	2115	24	24	142	16.66	
L2BRTTW5030L	2710	2865	2334	24	30	163	20.83	
L2BRTTW5030R	2710	2865	2334	24	30	163	20.83	

**L2BRTTW66xxL/R • Storage Tower With Coat Storage**

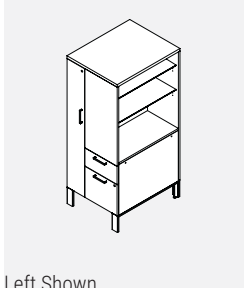

Left Shown

- Provides storage and privacy at the end of a table
- Box+file drawers; open compartment (66" high); coat storage with hinged door and 2 shelves.
- Specify Left or Right handed.
- Capable of supporting worksurface on one side (built-in threaded inserts to secure dedicated worksurface-supporting beam).
- Open side storage compartment internal height: 35.6".
- Optional Cable Basket suspends off storage unit's bottom and manages cables along the horizontal plane.
- LP chassis (specify LP finish), 1" top (specify LP or HP finish); metal handles; powder coated aluminum or anodized aluminum legs (specify paint finish).
- Anodized aluminum leg upcharge \$74.
- Black injection moulded pencil tray included.
- Optional e-lock available in the vertical position for the box, file drawer. Please specify V - Vertical and add \$304 list.
- Optional e-lock available in the horizontal position for the wardrobe. Please specify HR - Horizontal Right or HL - Horizontal Left and add \$284 list.

PRODUCT CODE	FINISH GROUP		SIZE/INCHES			WEIGHT		VOL FT <sup>3</sup>
	LP	HP	H	W	D	LBS		
L2BRTTW6624L	3173	3375	2750	24	24	170	22	
L2BRTTW6624R	3173	3375	2750	24	24	170	22	
L2BRTTW6630L	3523	3723	3033	24	30	195	27.5	
L2BRTTW6630R	3523	3723	3033	24	30	195	27.5	

**L2BRTC • Cushion**

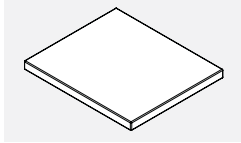

- Optional seat cushion may be added to any storage component.

PRODUCT CODE	SIZE/INCHES			WEIGHT VOL	
	H	W	D	LBS	FT <sup>3</sup>
L2BRTC	1.25	15.5	18	1	0.41

PRODUCT CODE	PRICE									
	GR1	GR2	GR3	GR4	GR5	GR6	GR7	GR8	GR9	GR10
L2BRTC	257	306	340	387	454	518	582	643	707	776

**L2BRPX3MA25xx • 25"-High System 3 Panel**

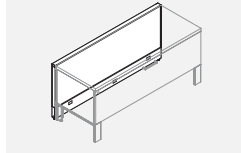

- 25" high System 3 panel facilitates seamless transition from a panel-based, enclosed office to an open one. It can be connected to a cluster of panels on one side and continue with power / data spine distribution into collaborative areas.
- 25" high System 3 panel also enables creation of a storage-based spine with full 8-wire, 4-circuit power and data capacity.

PRODUCT CODE	PRICE			SIZE/INCHES			WEIGHT VOL		
	GR1	GR2	OPT	H	W	D	LBS	FT <sup>3</sup>	
L2BRPX3MA2530	609	638	666	543	543	2.5	5.00	1.09	
L2BRPX3MA2536	663	720	757	617	617	2.5	6.00	1.30	
L2BRPX3MA2542	720	777	816	665	665	2.5	7.00	1.52	

**L2BRPX3GMA25xx • 25"-High System 3 Panel**

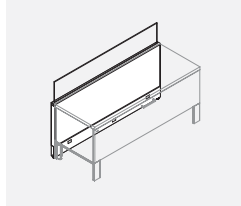

- 25" high System 3 panel facilitates seamless transition from a panel-based, enclosed office to an open one. It can be connected to a cluster of panels on one side and continue with power / data spine distribution into collaborative areas.
- 25" high System 3 panel also enables creation of a storage-based spine with full 8-wire, 4-circuit power and data capacity.
- B3 panel Top trim option provided with embedded, frame-less glass pane rising 8" above the top of the panel. For instance, when installed on 42" high B3 panel, overall height will be 50" high.
- There is 1.25" gap between two adjacent glass panes.
- Glass shipped separately, Allen key to set the glass pane plumb is provided with each panel.
- 5mm tempered glass, acid etched on one side or clear.
- Square corners on glass.
- Integrated adjustable brackets and extruded aluminum trim.
- Cannot be retrofit on-site.

PRODUCT CODE	PRICE			SIZE/INCHES			WEIGHT VOL		
	GR1	GR2	OPT	H	W	D	LBS	FT <sup>3</sup>	
L2BRPX3GMA2530	1193	1221	1284	1046	1046	2.5	5.00	1.09	
L2BRPX3GMA2536	1254	1311	1376	1121	1121	2.5	6.00	1.30	
L2BRPX3GMA2542	1331	1386	1456	1186	1186	2.5	7.00	1.52	

**L2HH • Hutch With Hinged Doors**

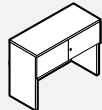

30" - 42" units

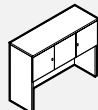

48" units

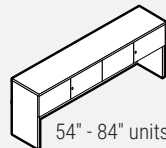

54" - 84" units

- 30" - 42" units come with one lock.
- 48" - 84" units come with two locks.
- Optional e-lock available in the horizontal position. Please specify HR - Horizontal Right or HL - Horizontal Left for the 48" wide unit and add \$304 list.
- Hutches 48" or longer require two e-locks.

PRODUCT CODE	FINISH		SIZE/INCHES			WEIGHT VOL	
	LP	W	H (LP/B)	W	D	LBS	FT <sup>3</sup>
L2HH30H36	1092	1223	36.81	30	16	138	17
L2HH36H36	1155	1304	36.81	36	16	145	18
L2HH42H36	1252	1436	36.81	42	16	163	19
L2HH48H36	1582	1772	36.81	48	16	180	22
L2HH54H36	1871	2067	36.81	54	16	208	26
L2HH60H36	1910	2154	36.81	60	16	216	29
L2HH66H36	2013	2284	36.81	66	16	233	30
L2HH72H36	2068	2357	36.81	72	16	251	32
L2HH78H36	2186	2553	36.81	78	16	264	46
L2HH84H36	2249	2584	36.81	84	16	277	50
L2HH30H43	1176	1296	43.81	30	16	158	19
L2HH36H43	1215	1364	43.81	36	16	166	20
L2HH42H43	1342	1536	43.81	42	16	175	22
L2HH48H43	1650	1840	43.81	48	16	191	24
L2HH54H43	2114	2311	43.81	54	16	209	31
L2HH60H43	1987	2229	43.81	60	16	227	32
L2HH66H43	2095	2366	43.81	66	16	249	33
L2HH72H43	2196	2487	43.81	72	16	259	36
L2HH78H43	2276	2640	43.81	78	16	272	48
L2HH84H43	2337	2682	43.81	84	16	285	53

**L2HH-A • Hutch With Aluminum Hinged Doors**

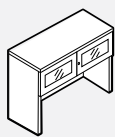

30" - 42" units

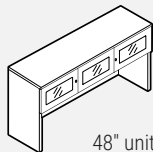

48" units

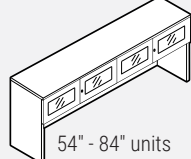

54" - 84" units

- 30" - 42" units come with one lock.
- 48" - 84" units come with two locks.
- Door frame is anodized aluminum.
- Glazing is frosted acrylic.
- Doors standard with no handles.
- E-locks not available for aluminum-framed glass doors.

PRODUCT CODE	FINISH LP	W	SIZE/INCHES			D	WEIGHT LBS	VOL FT <sup>3</sup>
			H (LP/B)	W	D			
L2HH30H36A	1736	1861	36.81	30	16	138	17	
L2HH36H36A	1836	1985	36.81	36	16	145	18	
L2HH42H36A	1955	2099	36.81	42	16	163	19	
L2HH48H36A	2564	2754	36.81	48	16	180	22	
L2HH54H36A	3125	3319	36.81	54	16	208	26	
L2HH60H36A	3206	3448	36.81	60	16	216	29	
L2HH66H36A	3323	3356	36.81	66	16	233	30	
L2HH72H36A	3411	3699	36.81	72	16	251	32	
L2HH78H36A	3530	3896	36.81	78	16	264	46	
L2HH84H36A	3629	3984	36.81	84	16	277	50	
L2HH30H43A	1815	1938	43.81	30	16	158	19	
L2HH36H43A	1899	2047	43.81	36	16	166	20	
L2HH42H43A	2042	2243	43.81	42	16	175	22	
L2HH48H43A	2632	2823	43.81	48	16	191	24	
L2HH54H43A	3200	3399	43.81	54	16	209	31	
L2HH60H43A	3286	3526	43.81	60	16	227	32	
L2HH66H43A	3402	3556	43.81	66	16	249	33	
L2HH72H43A	3544	3837	43.81	72	16	259	36	
L2HH78H43A	3621	3987	43.81	78	16	272	48	
L2HH84H43A	3725	4069	43.81	84	16	285	53	

**L2HO • Open Hutch**

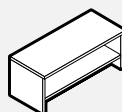

30"-48" 21" high units

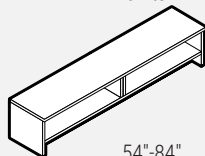

54"-84" 21" high units

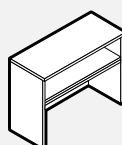

30"-48" units

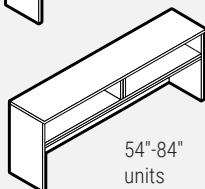

54"-84" units

PRODUCT CODE	FINISH LP	W	SIZE/INCHES			D	WEIGHT LBS	VOL FT <sup>3</sup>
			H (LP/B)	W	D			
L2HO30H21	741	876	20.56	30	16	73	11	
L2HO36H21	806	964	20.56	36	16	81	13	
L2HO42H21	886	1081	20.56	42	16	96	15	
L2HO48H21	1024	1226	20.56	48	16	100	18	
L2HO54H21	1161	1369	20.56	54	16	124	20	
L2HO60H21	1203	1462	20.56	60	16	134	22	
L2HO66H21	1278	1572	20.56	66	16	144	24	
L2HO72H21	1338	1646	20.56	72	16	152	26	
L2HO78H21	1407	1798	20.56	78	16	161	29	
L2HO84H21	1479	1839	20.56	84	16	169	31	
L2HO30H36	829	957	36.81	30	16	91	18	
L2HO36H36	870	981	36.81	36	16	109	19	
L2HO42H36	1027	1241	36.81	42	16	127	22	
L2HO48H36	1097	1301	36.81	48	16	131	24	
L2HO54H36	1251	1490	36.81	54	16	145	29	
L2HO60H36	1367	1624	36.81	60	16	138	31	
L2HO66H36	1446	1737	36.81	66	16	142	33	
L2HO72H36	1554	1867	36.81	72	16	149	36	
L2HO78H36	1587	1976	36.81	78	16	154	46	
L2HO84H36	1661	2026	36.81	84	16	158	50	
L2HO30H43	606	745	43.81	30	16	99	22	
L2HO36H43	662	776	43.81	36	16	108	26	
L2HO42H43	739	932	43.81	42	16	122	31	
L2HO48H43	820	1024	43.81	48	16	127	35	
L2HO54H43	989	1196	43.81	54	16	151	40	
L2HO60H43	1022	1279	43.81	60	16	161	44	
L2HO66H43	1090	1381	43.81	66	16	171	48	
L2HO72H43	1132	1441	43.81	72	16	178	53	
L2HO78H43	1197	1505	43.81	78	16	187	57	
L2HO84H43	1257	1619	43.81	84	16	196	62	

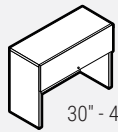

**L2HF • Hutch With Flip-Up Doors**

30" - 48" units

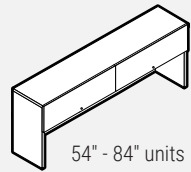

54" - 84" units

- 30" - 48" units come with one lock.
- 54" - 84" units come with two locks.
- Optional e-lock available in the horizontal position. Please specify HR - Horizontal Right and add \$304 list.
- Hutches 48" or longer require two e-locks.

PRODUCT CODE	FINISH		SIZE/INCHES			WEIGHT		VOL FT <sup>3</sup>
	LP	W	H (LP/B)	W	D	LBS		
L2HF30H36	1099	1142	36.81	30	16	142	18	
L2HF36H36	1173	1221	36.81	36	16	146	19	
L2HF42H36	1263	1312	36.81	42	16	158	22	
L2HF48H36	1268	1319	36.81	48	16	180	24	
L2HF54H36	1905	1980	36.81	54	16	182	29	
L2HF60H36	2022	2100	36.81	60	16	220	31	
L2HF66H36	2115	2200	36.81	66	16	253	33	
L2HF72H36	2179	2266	36.81	72	16	259	36	
L2HF78H36	2279	2369	36.81	78	16	264	46	
L2HF84H36	2362	2456	36.81	84	16	275	50	
L2HF30H43	1211	1259	43.81	30	16	150	22	
L2HF36H43	1219	1268	43.81	36	16	154	26	
L2HF42H43	1310	1362	43.81	42	16	166	31	
L2HF48H43	1403	1459	43.81	48	16	188	35	
L2HF54H43	1926	2003	43.81	54	16	194	40	
L2HF60H43	2079	2163	43.81	60	16	232	44	
L2HF66H43	2186	2274	43.81	66	16	265	48	
L2HF72H43	2245	2333	43.81	72	16	271	53	
L2HF78H43	2412	2511	43.81	78	16	276	57	
L2HF84H43	2501	2602	43.81	84	16	287	62	

**L2HHP • Hutch With Laminate Doors and Pigeon Holes**

36" - 42" units



48" units



60" - 72" units

- For tackboards, please use LTB21xx.
- 36" - 42" units come with one lock.
- 48" - 72" units come with two locks.
- Optional e-lock available in the horizontal position. Please specify HR - Horizontal Right or HL - Horizontal Left for the 48" wide unit and add \$304 list.
- Hutches 48" or longer require two e-locks.

PRODUCT CODE	FINISH		SIZE/INCHES			WEIGHT		VOL FT <sup>3</sup>
	LP	W	H (LP/B)	W	D	LBS		
L2HHP36	1399	1549	43.81	36	16	145	17	
L2HHP42	1486	1656	43.81	42	16	163	19	
L2HHP48	2007	2201	43.81	48	16	180	22	
L2HHP60	2424	2656	43.81	60	16	216	26	
L2HHP66	2503	2785	43.81	66	16	233	30	
L2HHP72	2607	2893	43.81	72	16	251	32	

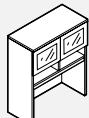
**L2HHP-A • Hutch With Aluminum Hinged Doors and Pigeon Holes**

36" - 42" units

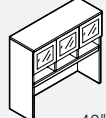

48" units

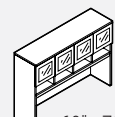

60" - 72" units

- For tackboards, please use LTB21xx.
- 36" - 42" units come with one lock.
- 48" - 72" units come with two locks.
- Door frame is anodized aluminum.
- Glazing is frosted acrylic.
- Doors standard with no handles.
- E-locks not available for aluminum-framed glass doors.

PRODUCT CODE	FINISH		SIZE/INCHES			WEIGHT		VOL FT <sup>3</sup>
	LP	W	H (LP/B)	W	D	LBS		
L2HHP36A	1993	2142	43.81	36	16.8	132	15	
L2HHP42A	2177	2349	43.81	42	16.8	148	17	
L2HHP48A	2918	3115	43.81	48	16.8	164	20	
L2HHP60A	3607	3839	43.81	60	16.8	196	24	
L2HHP66A	3733	4019	43.81	66	16.8	212	27	
L2HHP72A	3887	4176	43.81	72	16.8	228	29	

**L2HSD • Hutch With Sliding Laminate Doors**

• One lock included.

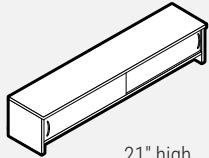

21" high units

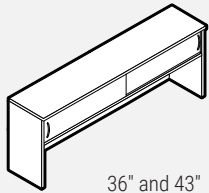

36" and 43" high units

PRODUCT CODE	FINISH LP	W	SIZE/INCHES			WEIGHT LBS	VOL FT <sup>3</sup>
			H (LP/B)	W	D		
L2HSD48H21	1364	1572	20.56	48	16	122	18
L2HSD54H21	1495	1731	20.56	54	16	146	20
L2HSD60H21	1550	1810	20.56	60	16	156	22
L2HSD66H21	1648	1938	20.56	66	16	166	24
L2HSD72H21	1698	1977	20.56	72	16	174	26
L2HSD78H21	1780	2146	20.56	78	16	183	29
L2HSD84H21	1834	2196	20.56	84	16	191	31
L2HSD48H36	1690	1906	36.81	48	16	141	24
L2HSD54H36	1867	2083	36.81	54	16	165	29
L2HSD60H36	1910	2180	36.81	60	16	175	31
L2HSD66H36	2025	2328	36.81	66	16	185	33
L2HSD72H36	2079	2378	36.81	72	16	193	36
L2HSD78H36	2191	2602	36.81	78	16	201	46
L2HSD84H36	2238	2639	36.81	84	16	210	50
L2HSD48H43	1790	2009	43.81	48	16	149	35
L2HSD54H43	1977	2182	43.81	54	16	173	40
L2HSD60H43	2029	2299	43.81	60	16	183	44
L2HSD66H43	2149	2449	43.81	66	16	193	48
L2HSD72H43	2265	2564	43.81	72	16	200	53
L2HSD78H43	2326	2731	43.81	78	16	209	57
L2HSD84H43	2400	2773	43.81	84	16	218	62

**L2HGSD • Hutch With Sliding Glass Doors**

• One lock included.  
• Glass is frosted tempered.

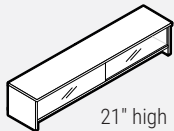

21" high units

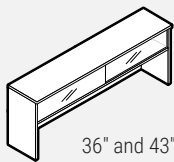

36" and 43" high units

PRODUCT CODE	FINISH LP	W	SIZE/INCHES			WEIGHT LBS	VOL FT <sup>3</sup>
			H (LP/B)	W	D		
L2HGSD48H21	2927	3146	20.56	48	16	139	18
L2HGSD54H21	3087	3330	20.56	54	16	163	20
L2HGSD60H21	3150	3418	20.56	60	16	184	22
L2HGSD66H21	3264	3567	20.56	66	16	194	24
L2HGSD72H21	3341	3663	20.56	72	16	201	26
L2HGSD78H21	3465	3842	20.56	78	16	210	29
L2HGSD84H21	3551	3922	20.56	84	16	219	31
L2HGSD48H36	3108	3330	36.81	48	16	157	24
L2HGSD54H36	3307	3523	36.81	54	16	182	29
L2HGSD60H36	3356	3626	36.81	60	16	202	31
L2HGSD66H36	3483	3787	36.81	66	16	212	33
L2HGSD72H36	3567	3915	36.81	72	16	220	36
L2HGSD78H36	3708	4116	36.81	78	16	229	46
L2HGSD84H36	3807	4181	36.81	84	16	238	50
L2HGSD48H43	3178	3488	43.81	48	16	165	35
L2HGSD54H43	3356	3693	43.81	54	16	189	40
L2HGSD60H43	3433	3795	43.81	60	16	210	44
L2HGSD66H43	3567	3915	43.81	66	16	220	48
L2HGSD72H43	3663	4098	43.81	72	16	228	53
L2HGSD78H43	3803	4271	43.81	78	16	237	57
L2HGSD84H43	3907	4372	43.81	84	16	245	62

**L2DSH • Double-Sided Hutch With Laminate Doors**

• Two locks included.

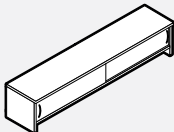

PRODUCT CODE	FINISH LP	W	SIZE/INCHES			WEIGHT LBS	VOL FT <sup>3</sup>
			H (LP/B)	W	D		
L2DSH60H21	1632	1890	20.56	60	16	156	22
L2DSH66H21	1732	2023	20.56	66	16	166	24
L2DSH72H21	1785	2035	20.56	72	16	201	26
L2DSH78H21	1880	2243	20.56	78	16	210	29
L2DSH84H21	1938	2294	20.56	84	16	219	31

**LTB27 • Tackboards for 43"-High Hutches**

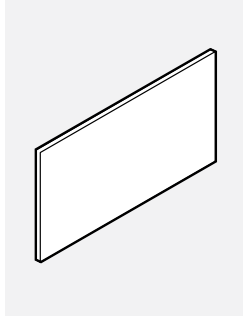

- Provides a tackable surface for notes and memos.
- Velcro for installation is included.
- Tackboards for hutches are 3" shorter than the overall size of the hutch.

PRODUCT CODE	FABRIC		SIZE/INCHES				WEIGHT		VOL FT <sup>3</sup>
	GR1	GR2	H	W	D	LBS			
LTB2727	384	422	27	27	1	7	0.46		
LTB2733	416	457	27	33	1	7	0.57		
LTB2739	449	475	27	39	1	7	0.67		
LTB2745	514	539	27	45	1	8	0.78		
LTB2751	589	606	27	51	1	8	0.88		
LTB2757	658	691	27	57	1	9	0.98		
LTB2763	725	768	27	63	1	9	1.09		
LTB2769	798	843	27	69	1	10	1.19		
LTB2775	892	950	27	75	1	10	1.30		
LTB2781	962	1035	27	81	1	11	1.40		

**LTB21 • Tackboards for 36"-High Hutches**

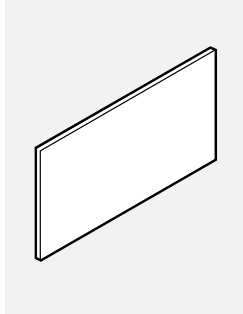

- Provides a tackable surface for notes and memos.
- Velcro for installation is included.
- Tackboards for hutches are 3" shorter than the overall size of the hutch.

PRODUCT CODE	FABRIC		SIZE/INCHES				WEIGHT		VOL FT <sup>3</sup>
	GR1	GR2	H	W	D	LBS			
LTB2127	302	330	21	27	1	4	0.38		
LTB2133	323	355	21	33	1	4	0.42		
LTB2139	352	372	21	39	1	4	0.49		
LTB2145	403	422	21	45	1	5	0.56		
LTB2151	462	475	21	51	1	5	0.63		
LTB2157	514	539	21	57	1	6	0.69		
LTB2163	567	600	21	63	1	6	0.76		
LTB2169	625	659	21	69	1	7	0.83		
LTB2175	697	743	21	75	1	7	0.89		
LTB2181	781	836	21	81	1	8	0.96		

**L2HC • Corner Curved Bookcase**

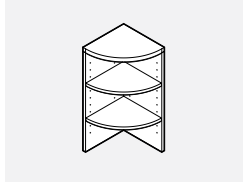

- Shipped knocked down (KD).

PRODUCT CODE	FINISH		SIZE/INCHES				WEIGHT		VOL FT <sup>3</sup>
	LP	W	H (LP/B)	W	D	LBS			
L2HC1637	794	914	36.81	16.87	16.87	57	7		
L2HC1644	843	965	43.81	16.87	16.87	63	8		

**L2HBK • Open Hutch Bookcase**

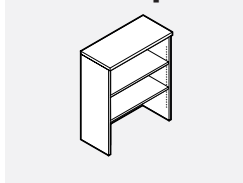

- Shipped knocked down (KD).

PRODUCT CODE	FINISH		SIZE/INCHES				WEIGHT		VOL FT <sup>3</sup>
	LP	W	H (LP/B)	W	D	LBS			
L2HBK303	928	1086	36.81	30	16.875	109	12		
L2HBK363	1005	1191	36.81	36	16.875	123	14		
L2HBK304	1018	1176	43.81	30	16.875	119	13		
L2HBK364	1073	1261	43.81	36	16.875	135	17		

**L2WHO • Wall-Mounted Open Storage**

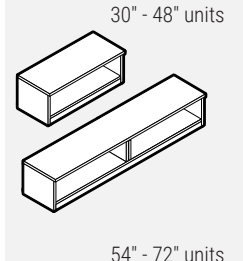

PRODUCT CODE	FINISH		SIZE/INCHES				WEIGHT		VOL FT <sup>3</sup>
	LP	W	H (LP/B)	H(W)	W	D	LBS		
L2WHO30	665	794	16.75	17.18	30	16	69	7	
L2WHO36	711	892	16.75	17.18	36	16	78	8	
L2WHO42	820	998	16.75	17.18	42	16	87	9	
L2WHO48	873	1068	16.75	17.18	48	16	97	10	
L2WHO54	941	1184	16.75	17.18	54	16	106	11	
L2WHO60	1176	1326	16.75	17.18	60	16	117	12	
L2WHO66	1232	1369	16.75	17.18	66	16	125	13	
L2WHO72	1289	1505	16.75	17.18	72	16	139	14	

**L2WHH • Wall-Mounted Hinged Door**

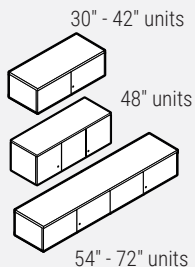

- 30" - 42" units come with one lock.
- 48" - 72" units come with two locks.
- Optional e-lock available in the horizontal position. Please specify HR - Horizontal Right or HL - Horizontal Left for the 48" wide unit and add \$304 list.
- Hitches 48" or longer require two e-locks.

PRODUCT CODE	FINISH LP	W	SIZE / INCHES				WEIGHT		VOL FT <sup>3</sup>
			H (LP/B)	H (W)	W	D	LBS		
L2WHH30	900	998	16.75	17.18	30	16	120	7	
L2WHH36	965	1081	16.75	17.18	36	16	139	8	
L2WHH42	1056	1197	16.75	17.18	42	16	143	9	
L2WHH48	1319	1475	16.75	17.18	48	16	145	10	
L2WHH54	1563	1739	16.75	17.18	54	16	155	11	
L2WHH60	1619	1759	16.75	17.18	60	16	165	12	
L2WHH66	1695	1856	16.75	17.18	66	16	175	13	
L2WHH72	1769	2003	16.75	17.18	72	16	187	14	

**L2WHF • Wall-Mounted Flip-Up Door**

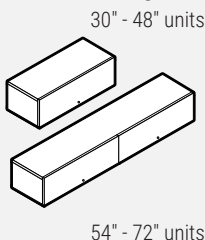

- 30" - 48" units come with one lock.
- 54" - 72" units come with two locks.
- Optional e-lock available in the horizontal position. Please specify HR - Horizontal Right or HL - Horizontal Left add \$304 list.
- Hitches 48" or longer require two e-locks.

PRODUCT CODE	FINISH LP	W	SIZE / INCHES				WEIGHT		VOL FT <sup>3</sup>
			H (LP/B)	H (W)	W	D	LBS		
L2WHF30	1005		17.63	17.63	30	16	94	7	
L2WHF36	1065		17.63	17.63	36	16	103	8	
L2WHF42	1161		17.63	17.63	42	16	113	9	
L2WHF48	1219		17.63	17.63	48	16	123	10	
L2WHF54	1798		17.63	17.63	54	16	130	11	
L2WHF60	1852		17.63	17.63	60	16	141	12	
L2WHF66	1961		17.63	17.63	66	16	151	13	
L2WHF72	2011		17.63	17.63	72	16	163	14	

**L2WHH • Wall-Mounted Unit With Aluminum Doors**

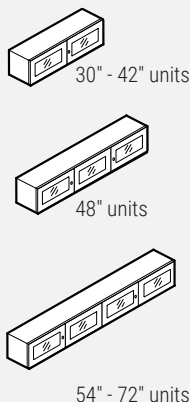

- Horizontal wall rails included.
- 30" - 42" units come with one lock.
- 48" - 72" units come with two locks.
- Door frame is anodized aluminum.
- Glazing is frosted acrylic.
- Doors standard with no handles.
- E-locks not available for aluminum-framed glass doors.

PRODUCT CODE	FINISH LP	W	SIZE / INCHES				WEIGHT		VOL FT <sup>3</sup>
			H (LP/B)	H (W)	W	D	LBS		
L2WHH30A	1520	1617	16.75	17.19	30	16	109	6	
L2WHH36A	1639	1756	16.75	17.19	36	16	126	7	
L2WHH42A	1780	1926	16.75	17.19	42	16	130	8	
L2WHH48A	2274	2434	16.75	17.19	48	16	132	9	
L2WHH54A	2746	2925	16.75	17.19	54	16	141	10	
L2WHH60A	2859	2995	16.75	17.19	60	16	150	11	
L2WHH66A	2967	3127	16.75	17.19	66	16	159	12	
L2WHH72A	3112	3347	16.75	17.19	72	16	170	13	

**L2WSD • Wall-Mounted Unit With Sliding Laminate Doors**

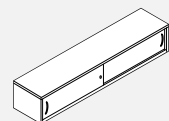

- Wall mounting horizontal rails included.
- One lock included.

PRODUCT CODE	FINISH LP	W	SIZE / INCHES				WEIGHT		VOL FT <sup>3</sup>
			H (LP/B)	H (W)	W	D	LBS		
L2WSD36	1334	1501	16.75	17.19	36	16	128	7	
L2WSD42	1456	1652	16.75	17.19	42	16	130	8	
L2WSD48	1509	1704	16.75	17.19	48	16	132	9	
L2WSD54	1669	1907	16.75	17.19	54	16	141	10	
L2WSD60	1743	2006	16.75	17.19	60	16	150	11	
L2WSD66	1862	2163	16.75	17.19	66	16	159	12	
L2WSD72	1916	2234	16.75	17.19	72	16	170	13	

**L2WGSD • Wall-Mounted Unit With Sliding Glass Doors**

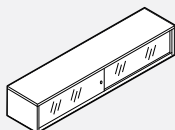

- Wall mounting horizontal rails included.
- Standard recessed chrome pull.
- Lock is included and must be installed at time of manufacturing, please specify key number.
- Frosted tempered glass.

PRODUCT CODE	FINISH LP	W	SIZE / INCHES				WEIGHT		VOL FT <sup>3</sup>
			H (LP/B)	H (W)	W	D	LBS		
L2WGSD36	2479	2873	16.75	17.19	36	16	128	7	
L2WGSD42	2898	3099	16.75	17.19	42	16	130	8	
L2WGSD48	2967	3186	16.75	17.19	48	16	132	9	
L2WGSD54	3103	3347	16.75	17.19	54	16	141	10	
L2WGSD60	3184	3455	16.75	17.19	60	16	150	11	
L2WGSD66	3319	3628	16.75	17.19	66	16	159	12	
L2WGSD72	3448	3776	16.75	17.19	72	16	170	13	

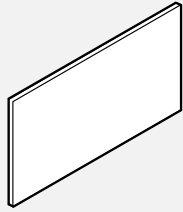
**LTB20 • Tackboards for Wall-Mounted Units**

- Please specify wall rails BHV01 and BHV02 separately, see Boulevard Price List.
- Provides a tackable surface for notes and memos.
- Mounting brackets for installation included.
- Tackboards for Wall-Mounted Unit. Wall Rails (BHV01 and BHV02) must be ordered separately.
- For tackboards longer than 60", please include an additional BHV01 at the center.

PRODUCT CODE	FABRIC		SIZE/INCHES			WEIGHT		VOL FT <sup>3</sup>
	GR1	GR2	H	W	D	LBS		
LTB2030	302	317	19.5	30	1	4	0.38	
LTB2036	323	342	19.5	36	1	4	0.42	
LTB2042	352	378	19.5	42	1	4	0.49	
LTB2048	403	427	19.5	48	1	5	0.56	
LTB2054	462	475	19.5	54	1	5	0.63	
LTB2060	514	539	19.5	60	1	6	0.69	
LTB2066	567	600	19.5	66	1	6	0.76	
LTB2072	625	649	19.5	72	1	7	0.83	
LTB2078	697	723	19.5	78	1	7	0.89	
LTB2084	781	805	19.5	84	1	8	0.96	

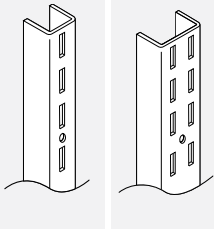
**BHV • Component Wall Adapter - Single and Double**

- Used to attach system components to fixed wall.
- Panel frame finish.
- The vertical wall adapter is a "U" shaped channel with a vertical row of slots with 1" centers.
- The double Component Wall Adapter has a double row of slots with 1" centers.
- Comes in 60" length only.
- Care should be taken to mount adapters only to wall studs using correct fasteners.
- Does not include mounting hardware. Mounting hardware selection to be based on wall material.
- Failure to do this may result in collapse of the unit and subsequent possible personal injury.
- Sold in pairs.

PRODUCT CODE	PRICE	SIZE/INCHES			WEIGHT		VOL FT <sup>3</sup>
		H	W	D	LBS		
BHV01	77	60	0.75	0.5	4	0.009	
BHV02	91	60	1.50	0.5	5	0.026	

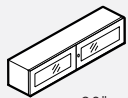
**L2PHH • Boulevard Panel-Mounted Unit With Aluminum Doors**

30" - 42" units

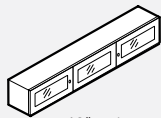

48" unit

- 30" - 42" units comes with one lock
- 48" Unit comes with two locks.
- Door frame is anodized aluminum.
- Glazing is frosted acrylic.
- Doors standard with no handles.
- E-locks not available for aluminum-framed glass doors.

PRODUCT CODE	FINISH		SIZE/INCHES				WEIGHT		VOL FT <sup>3</sup>
	LP	W	H (LP/B)	H (W)	W	D	LBS		
L2PHH30A	1694	1862	16.75	17.19	30	14.75	111	6	
L2PHH36A	1803	2006	16.75	17.19	36	14.75	128	7	
L2PHH42A	1934	2165	16.75	17.19	42	14.75	132	8	
L2PHH48A	2411	2726	16.75	17.19	48	14.75	134	9	

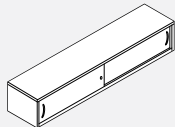
**L2PSD • Boulevard Panel-Mounted Unit With Sliding Laminate Doors**

- Hardware included to mount the unit on the panel.
- One lock included.

PRODUCT CODE	FINISH		SIZE/INCHES				WEIGHT		VOL FT <sup>3</sup>
	LP	W	H (LP/B)	H (W)	W	D	LBS		
L2PSD36	1404	1565	16.75	17.19	36	14.75	123	7	
L2PSD42	1502	1698	16.75	17.19	42	14.75	132	8	
L2PSD48	1539	1733	16.75	17.19	48	14.75	141	9	

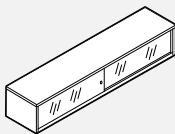
**L2PGSD • Boulevard Panel-Mounted Unit With Sliding Glass Doors**

- Hardware included to mount the unit on the panel.
- One lock included.
- Standard recessed chrome pull.

PRODUCT CODE	FINISH		SIZE/INCHES				WEIGHT		VOL FT <sup>3</sup>
	LP	W	H (LP/B)	H (W)	W	D	LBS		
L2PGSD36	2829	2988	16.75	17.19	36	14.75	123	7	
L2PGSD42	2946	3148	16.75	17.19	42	14.75	132	8	
L2PGSD48	2999	3217	16.75	17.19	48	14.75	141	9	

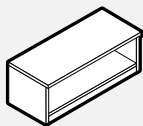
**L2PHO • Boulevard Panel-Mounted Unit, Open Shelf**

- Hardware included to mount the unit on the panel.

PRODUCT CODE	FINISH		SIZE/INCHES				WEIGHT		VOL FT <sup>3</sup>
	LP	W	H (LP/B)	H (W)	W	D	LBS		
L2PHO30	696	799	16.75	17.18	30	14.75	72	7	
L2PHO36	739	902	16.75	17.18	36	14.75	80	8	
L2PHO42	757	977	16.75	17.18	42	14.75	89	9	
L2PHO48	802	1060	16.75	17.18	48	14.75	99	10	

**L2PHH • Boulevard Panel-Mounted Hinged Door Overhead Storage**

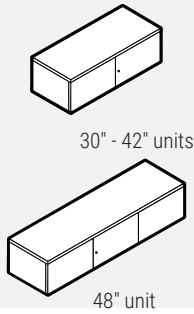

- Hardware included to mount the unit on the panel.
- One lock included.
- Optional e-lock available in the horizontal position. Please specify HR - Horizontal Right or HL - Horizontal Left for the 48" wide unit and add \$304 list.
- Hatches 48" or longer require two e-locks.

PRODUCT CODE	FINISH LP	W	SIZE/INCHES				WEIGHT		VOL FT <sup>3</sup>
			H(LP/B)	H(W)	W	D	LBS		
L2PHH30	1072	1237	16.75	17.18	30	14.75	122	7	
L2PHH36	1128	1328	16.75	17.18	36	14.75	141	8	
L2PHH42	1208	1432	16.75	17.18	42	14.75	145	9	
L2PHH48	1456	1765	16.75	17.18	48	14.75	147	10	

**L2PHF • Boulevard Panel-Mounted Flip-Up Door Overhead Storage**

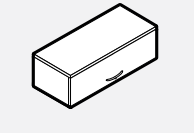

- Hardware included to mount the unit on the panel.
- One lock included.
- Optional e-lock available in the horizontal position. Please specify HR - Horizontal Right and add \$304 list.

PRODUCT CODE	FINISH LP	SIZE/INCHES				WEIGHT		VOL FT <sup>3</sup>
		H(LP)	W	D	LBS			
L2PHF30	1092	17.63	30	16	94	7		
L2PHF36	1145	17.63	36	16	103	8		
L2PHF42	1211	17.63	42	16	113	9		
L2PHF48	1274	17.63	48	16	123	10		

**L2SOHD • Stack-On 2-High Cabinet With Hinged Doors and Adjustable Shelf for 1-High Storage**

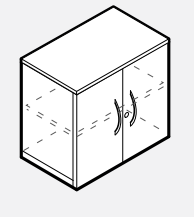

- One lock included.
- Optional e-lock available in the horizontal position. Please specify HR - Horizontal Right and add \$304 list.

PRODUCT CODE	FINISH LP	W	SIZE/INCHES				WEIGHT		VOL FT <sup>3</sup>
			H(LP)	H(W)	W	D	LBS		
<b>one door</b>									
L2SOHDL15	806	895	29.63	29.63	15	16	95	7	
L2SOHDR15	806	895	29.63	29.63	15	16	95	7	
L2SOHDL18	829	916	29.63	29.63	18	16	99	9	
L2SOHDR18	829	916	29.63	29.63	18	16	99	9	
<b>double door</b>									
L2SOHD30	1156	1294	29.63	29.63	30	16	171	11	
L2SOHD36	1290	1456	29.63	29.63	36	16	178	13	

**L2SOALD • Stack-On 2-High Cabinet With Aluminum Hinged Doors and Adjustable Shelf for 1-High Storage**

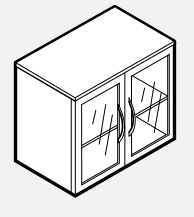

- No lock available for the one door units, one lock included for the double door units.
- Door frame is anodized aluminum.
- Glazing is frosted acrylic.
- Doors standard with no handles.
- E-locks not available for aluminum-framed glass doors.

PRODUCT CODE	FINISH LP	W	SIZE/INCHES				WEIGHT		VOL FT <sup>3</sup>
			H(LP)	H(W)	W	D	LBS		
<b>one door</b>									
L2SOALDL15	1342	1429	29.63	29.63	15	16	88	7	
L2SOALDR15	1342	1429	29.63	29.63	15	16	88	7	
L2SOALDL18	1398	1486	29.63	29.63	18	16	94	9	
L2SOALDR18	1398	1486	29.63	29.63	18	16	94	9	
<b>double door</b>									
L2SOALD30	2266	2403	29.63	29.63	30	16	164	11	
L2SOALD36	2456	2617	29.63	29.63	36	16	172	13	

**L2SOO • Stack-On 2-High Cabinet With Adjustable Shelf for 1-High Storage**

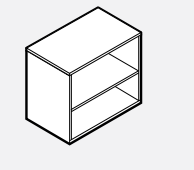

PRODUCT CODE	FINISH LP	W	SIZE/INCHES				WEIGHT		VOL FT <sup>3</sup>
			H(LP)	H(W)	W	D	LBS		
L2SOO15	589	684	29.63	29.63	15	16	61	7	
L2SOO18	603	700	29.63	29.63	18	16	72	8	
L2SOO30	775	923	29.63	29.63	30	16	88	14	
L2SOO36	907	1086	29.63	29.63	36	16	94	19	

**L2SOSD • Stack-On 2-High Cabinet With Sliding Door, Divider and Adjustable Shelves for 1-High Storage**

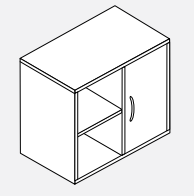

- Includes one sliding door.
- Lock not included.

PRODUCT CODE	FINISH LP	W	SIZE/INCHES				WEIGHT		VOL FT <sup>3</sup>
			H(LP)	H(W)	W	D	LBS		
L2SOSD30	1184	1321	29.63	29.63	30	16	116	14	
L2SOSD36	1394	1561	29.63	29.63	36	16	121	19	

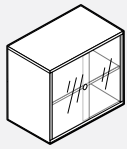
**L2SOGSD • Stack-On 2-High Cabinet With Sliding Glass Doors and Adjustable Shelf for 1-High Storage**

- One lock included.
- Standard recessed chrome pull.
- Glass is frosted tempered.

PRODUCT CODE	FINISH LP	W	SIZE/INCHES				D	WEIGHT LBS	VOL FT <sup>3</sup>
			H(LP)	H(W)	W	D			
L2SOGSD30	2792	2914	29.63	29.63	30	16	116	14	
L2SOGSD36	3056	3204	29.63	29.63	36	16	121	19	

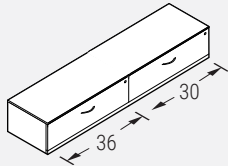
**L2CR1H1H • Credenza, 1-High File/File**

- Two locks included.
- Optional e-lock available in the vertical position. Please specify V - Vertical and add \$304 list.
- Hutches 48" or longer require two e-locks.

PRODUCT CODE	FINISH LP	B	W	SIZE/INCHES				D	WEIGHT LBS	VOL FT <sup>3</sup>
				H(LP/B)	H(W)	W	D			
L2CR1H1H2060	2137	2246	2295	19.94	20.5	60	20	189	22	
L2CR1H1H2066	2238	2358	2411	19.94	20.5	66	20	209	24	
L2CR1H1H2072	2272	2403	2461	19.94	20.5	72	20	246	26	
L2CR1H1H2460	2222	2337	2391	19.94	20.5	60	24	189	22	
L2CR1H1H2466	2328	2451	2509	19.94	20.5	66	24	209	24	
L2CR1H1H2472	2362	2501	2560	19.94	20.5	72	24	246	26	

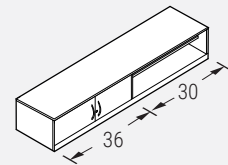
**L2CR2DO • Credenza, 1-High 2 Doors / Open Shelf**

- One lock included.
- One height-adjustable shelf included.
- Optional e-lock available in the horizontal position. Please specify HR - Horizontal Right and add \$304 list.

PRODUCT CODE	FINISH LP	B	W	SIZE/INCHES				D	WEIGHT LBS	VOL FT <sup>3</sup>
				H(LP/B)	H(W)	W	D			
L2CR2DO2060	1829	2030	2141	19.94	20.5	60	20	169	22	
L2CR2DO2066	1910	2133	2250	19.94	20.5	66	20	180	24	
L2CR2DO2072	1993	2238	2369	19.94	20.5	72	20	191	26	
L2CR2DO2460	1903	2114	2225	19.94	20.5	60	24	169	22	
L2CR2DO2466	1987	2218	2342	19.94	20.5	66	24	180	24	
L2CR2DO2472	2076	2326	2463	19.94	20.5	72	24	191	26	

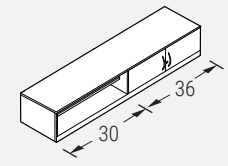
**L2CRO2D • Credenza, 1-High Open Shelf / 2 Doors**

- One lock included.
- One height-adjustable shelf included.
- Optional e-lock available in the horizontal position. Please specify HR - Horizontal Right and add \$304 list.

PRODUCT CODE	FINISH LP	B	W	SIZE/INCHES				D	WEIGHT LBS	VOL FT <sup>3</sup>
				H(LP/B)	H(W)	W	D			
L2CRO2D2060	1829	2030	2141	19.94	20.5	60	20	169	22	
L2CRO2D2066	1910	2133	2250	19.94	20.5	66	20	180	24	
L2CRO2D2072	1993	2238	2369	19.94	20.5	72	20	191	26	
L2CRO2D2460	1903	2114	2225	19.94	20.5	60	24	169	22	
L2CRO2D2466	1987	2218	2342	19.94	20.5	66	24	180	24	
L2CRO2D2472	2076	2326	2463	19.94	20.5	72	24	191	26	

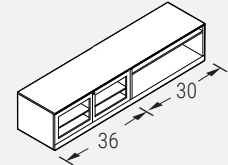
**L2CR2ADO • Credenza, 2 Aluminum Doors / 1-High Open Shelf**

- One lock included.
- One height-adjustable shelf included.
- Door frame is anodized aluminum.
- Glazing is frosted acrylic.
- Doors standard with no handles.

PRODUCT CODE	FINISH LP	B	W	SIZE/INCHES				D	WEIGHT LBS	VOL FT <sup>3</sup>
				H(LP/B)	H(W)	W	D			
L2CR2ADO2060	2474	2679	2790	19.94	20.5	60	20	154	20	
L2CR2ADO2066	2610	2833	2953	19.94	20.5	66	20	164	22	
L2CR2ADO2072	2693	2940	3073	19.94	20.5	72	20	174	24	
L2CR2ADO2460	2551	2763	2949	19.94	20.5	60	24	154	20	
L2CR2ADO2466	2687	2921	3046	19.94	20.5	66	24	164	22	
L2CR2ADO2472	2775	3031	3167	19.94	20.5	72	24	174	24	

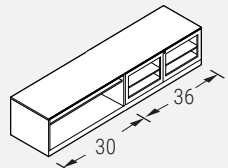
**L2CRO2AD • Credenza, 1-High Open Shelf / 2 Aluminum Doors**

- One lock included.
- One height-adjustable shelf included.
- Door frame is anodized aluminum.
- Glazing is frosted acrylic.
- Doors standard with no handles.

PRODUCT CODE	FINISH LP	B	W	SIZE/INCHES				D	WEIGHT LBS	VOL FT <sup>3</sup>
				H(LP/B)	H(W)	W	D			
L2CRO2AD2060	2474	2679	2790	19.94	20.5	60	20	154	20	
L2CRO2AD2066	2610	2833	2953	19.94	20.5	66	20	164	22	
L2CRO2AD2072	2693	2940	3073	19.94	20.5	72	20	174	24	
L2CRO2AD2460	2551	2763	2949	19.94	20.5	60	24	154	20	
L2CRO2AD2466	2687	2921	3046	19.94	20.5	66	24	164	22	
L2CRO2AD2472	2775	3031	3167	19.94	20.5	72	24	174	24	

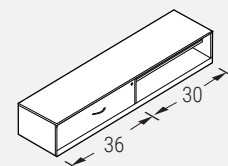
**L2CR1HO • Credenza, 1-High File / Open Shelf**

- One lock included.
- One height-adjustable shelf included.
- Optional e-lock available in the vertical position. Please specify V - Vertical and add \$304 list.

PRODUCT CODE	FINISH LP	B	W	SIZE/INCHES				D	WEIGHT LBS	VOL FT <sup>3</sup>
				H(LP/B)	H(W)	W	D			
L2CR1HO2060	1860	2023	2138	19.94	20.5	60	20	179	22	
L2CR1HO2066	1938	2115	2254	19.94	20.5	66	20	189	24	
L2CR1HO2072	2079	2274	2386	19.94	20.5	72	20	200	26	
L2CR1HO2460	1934	2103	2224	19.94	20.5	60	24	179	22	
L2CR1HO2466	2014	2197	2344	19.94	20.5	66	24	189	24	
L2CR1HO2472	2163	2364	2481	19.94	20.5	72	24	200	26	

**L2CR01H • Credenza, Open Shelf / 1-High File**

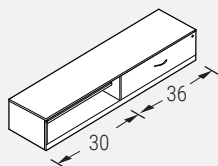

- One lock included.
- One height-adjustable shelf included.
- Optional e-lock available in the vertical position. Please specify V - Vertical and add \$304 list.

PRODUCT CODE	FINISH			SIZE/INCHES				WEIGHT		VOL FT <sup>3</sup>
	LP	B	W	H(LP/B)	H(W)	W	D	LBS		
L2CR01H2060	1860	2023	2138	19.94	20.5	60	20	179	22	
L2CR01H2066	1938	2115	2254	19.94	20.5	66	20	189	24	
L2CR01H2072	2079	2274	2386	19.94	20.5	72	20	200	26	
L2CR01H2460	1934	2103	2224	19.94	20.5	60	24	179	22	
L2CR01H2466	2014	2197	2344	19.94	20.5	66	24	189	24	
L2CR01H2472	2163	2364	2481	19.94	20.5	72	24	200	26	

**L2CR01H • Credenza, 1-High File / 2 Door**

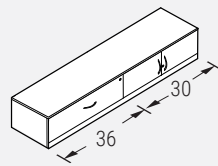

- Two locks included.
- Optional e-lock available in the vertical position for the file drawer. Please specify V - Vertical and add \$304 list.
- Optional e-lock available in the horizontal position. Please specify HR - Horizontal Right and add \$304 list.

PRODUCT CODE	FINISH			SIZE/INCHES				WEIGHT		VOL FT <sup>3</sup>
	LP	B	W	H(LP/B)	H(W)	W	D	LBS		
L2CR1H2D2060	2262	2378	2531	19.94	20.5	60	20	199	22	
L2CR1H2D2066	2284	2416	2733	19.94	20.5	66	20	209	24	
L2CR1H2D2072	2424	2671	2800	19.94	20.5	72	20	220	26	
L2CR1H2D2460	2353	2473	2635	19.94	20.5	60	24	199	22	
L2CR1H2D2466	2374	2515	2841	19.94	20.5	66	24	209	24	
L2CR1H2D2472	2520	2776	2913	19.94	20.5	72	24	220	26	

**L2CR2D1H • Credenza, 2 Doors / 1-High File**

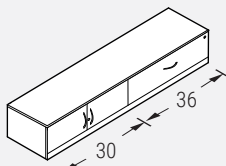

- Two locks included.
- Optional e-lock available in the vertical position for the file drawer. Please specify V - Vertical and add \$304 list.
- Optional e-lock available in the horizontal position. Please specify HR - Horizontal Right and add \$304 list.

PRODUCT CODE	FINISH			SIZE/INCHES				WEIGHT		VOL FT <sup>3</sup>
	LP	B	W	H(LP/B)	H(W)	W	D	LBS		
L2CR2D1H2060	2262	2378	2531	19.94	20.5	60	20	199	22	
L2CR2D1H2066	2284	2416	2733	19.94	20.5	66	20	209	24	
L2CR2D1H2072	2424	2671	2800	19.94	20.5	72	20	220	26	
L2CR2D1H2460	2353	2473	2635	19.94	20.5	60	24	199	22	
L2CR2D1H2466	2374	2515	2841	19.94	20.5	66	24	209	24	
L2CR2D1H2472	2520	2776	2913	19.94	20.5	72	24	220	26	

**L2CR1H2AD • Credenza, 1-High File / 2 Aluminum Doors**

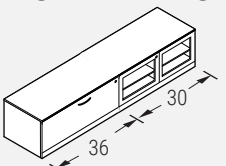

- Two locks included.
- One height-adjustable shelf included.
- Door frame is anodized aluminum.
- Glazing is frosted acrylic.
- Doors standard with no handles.
- Optional e-lock available in the vertical position. Please specify V - Vertical and add \$304 list.
- E-locks not available for aluminum-framed glass doors.

PRODUCT CODE	FINISH			SIZE/INCHES				WEIGHT		VOL FT <sup>3</sup>
	LP	B	W	H(LP/B)	H(W)	W	D	LBS		
L2CR1H2AD2060	2915	3031	3188	19.94	20.5	60	20	181	20	
L2CR1H2AD2066	2988	3121	3444	19.94	20.5	66	20	190	22	
L2CR1H2AD2072	3131	3378	3512	19.94	20.5	72	20	200	24	
L2CR1H2AD2460	3005	3127	3292	19.94	20.5	60	24	181	20	
L2CR1H2AD2466	3080	3221	3556	19.94	20.5	66	24	190	22	
L2CR1H2AD2472	3227	3487	3623	19.94	20.5	72	24	200	24	

**L2CR2AD1H • Credenza, 2 Aluminum Doors / 1-High File**

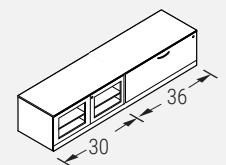

- Two locks included.
- One height-adjustable shelf included.
- Door frame is anodized aluminum.
- Glazing is frosted acrylic.
- Doors standard with no handles.
- Optional e-lock available in the vertical position. Please specify V - Vertical and add \$304 list.
- E-locks not available for aluminum-framed glass doors.

PRODUCT CODE	FINISH			SIZE/INCHES				WEIGHT		VOL FT <sup>3</sup>
	LP	B	W	H(LP/B)	H(W)	W	D	LBS		
L2CR2AD1H2060	2915	3031	3188	19.94	20.5	60	20	181	20	
L2CR2AD1H2066	2988	3121	3444	19.94	20.5	66	20	190	22	
L2CR2AD1H2072	3131	3378	3512	19.94	20.5	72	20	200	24	
L2CR2AD1H2460	3005	3127	3292	19.94	20.5	60	24	181	20	
L2CR2AD1H2466	3080	3221	3556	19.94	20.5	66	24	190	22	
L2CR2AD1H2472	3227	3487	3623	19.94	20.5	72	24	200	24	

**L2DSCR1H • Double-Sided 1-High Credenza Lateral**

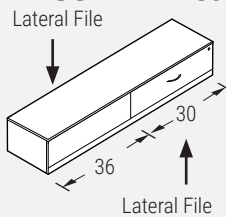

- Two locks included.
- Optional e-lock available in the vertical position. Please specify V - Vertical and add \$304 list.
- Credenzas require two e-locks.

PRODUCT CODE	FINISH			SIZE/INCHES				WEIGHT		VOL FT <sup>3</sup>
	LP	B	W	H(LP/B)	H(W)	W	D	LBS		
L2DSCR1H2060	2519	2640	2727	19.94	20.5	60	20	196	22	
L2DSCR1H2066	2598	2731	2841	19.94	20.5	66	20	206	24	
L2DSCR1H2072	2677	2823	2958	19.94	20.5	72	20	217	26	
L2DSCR1H2460	2618	2746	2837	19.94	20.5	60	24	196	22	
L2DSCR1H2466	2700	2840	2957	19.94	20.5	66	24	206	24	
L2DSCR1H2472	2784	2935	3078	19.94	20.5	72	24	217	26	

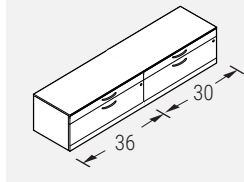

**L2CRBFBF • Credenza, Box/File / Box/File**

- Two locks included.
- Optional e-lock available in the vertical position. Please specify V - Vertical and add \$304 list.
- Credenzas require two e-locks.

PRODUCT CODE	FINISH LP	B	W	SIZE/INCHES				D	WEIGHT LBS	VOL FT <sup>3</sup>
				H (LP/B)	H (W)	W	D			
L2CRBFBF2060	2902	3010	3062	19.94	20.5	60	20	218	20	
L2CRBFBF2066	3015	3139	3193	19.94	20.5	66	20	228	22	
L2CRBFBF2072	3066	3200	3258	19.94	20.5	72	20	239	24	
L2CRBFBF2460	2988	3103	3158	19.94	20.5	60	24	218	20	
L2CRBFBF2466	3108	3235	3292	19.94	20.5	66	24	228	22	
L2CRBFBF2472	3158	3298	3358	19.94	20.5	72	24	239	24	

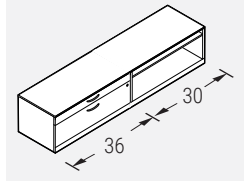
**L2CRBFO • Credenza, Box/File / Open**

- One lock included.
- One height-adjustable shelf included.
- Optional e-lock available in the vertical position. Please specify V - Vertical and add \$304 list.

PRODUCT CODE	FINISH LP	B	W	SIZE/INCHES				D	WEIGHT LBS	VOL FT <sup>3</sup>
				H (LP/B)	H (W)	W	D			
L2CRBFO2060	2252	2418	2537	19.94	20.5	60	20	202	20	
L2CRBFO2066	2347	2525	2666	19.94	20.5	66	20	220	22	
L2CRBFO2072	2489	2687	2801	19.94	20.5	72	20	254	24	
L2CRBFO2460	2343	2515	2639	19.94	20.5	60	24	202	20	
L2CRBFO2466	2440	2639	2774	19.94	20.5	66	24	220	22	
L2CRBFO2472	2587	2794	2913	19.94	20.5	72	24	254	24	

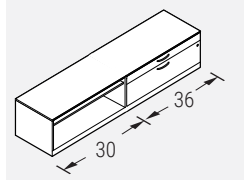
**L2CROBF • Credenza, Open / Box/File**

- One lock included.
- One height-adjustable shelf included.
- Optional e-lock available in the vertical position. Please specify V - Vertical and add \$304 list.

PRODUCT CODE	FINISH LP	B	W	SIZE/INCHES				D	WEIGHT LBS	VOL FT <sup>3</sup>
				H (LP/B)	H (W)	W	D			
L2CROBF2060	2252	2418	2537	19.94	20.5	60	20	202	20	
L2CROBF2066	2347	2525	2666	19.94	20.5	66	20	220	22	
L2CROBF2072	2489	2687	2801	19.94	20.5	72	20	254	24	
L2CROBF2460	2343	2515	2639	19.94	20.5	60	24	202	20	
L2CROBF2466	2440	2639	2774	19.94	20.5	66	24	220	22	
L2CROBF2472	2587	2794	2913	19.94	20.5	72	24	254	24	

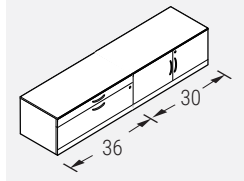
**L2CRBF • Credenza, Box/File / 2 Doors**

- Two locks included.
- One height-adjustable shelf included.
- Optional e-lock available in the vertical position for the file drawer. Please specify V - Vertical and add \$304 list.
- Optional e-lock available in the horizontal position. Please specify HR - Horizontal Right and add \$304 list.

PRODUCT CODE	FINISH LP	B	W	SIZE/INCHES				D	WEIGHT LBS	VOL FT <sup>3</sup>
				H (LP/B)	H (W)	W	D			
L2CRBF2D2060	2662	2778	2936	19.94	20.5	60	20	214	20	
L2CRBF2D2066	2698	2830	3154	19.94	20.5	66	20	224	22	
L2CRBF2D2072	2840	3087	3221	19.94	20.5	72	20	235	24	
L2CRBF2D2460	2770	2889	3051	19.94	20.5	60	24	214	20	
L2CRBF2D2466	2806	2945	3280	19.94	20.5	66	24	224	22	
L2CRBF2D2472	2954	3211	3351	19.94	20.5	72	24	235	24	

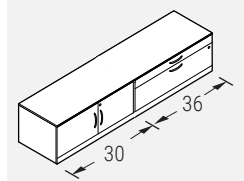
**L2CR2DBF • Credenza, 2 Doors / Box/File**

- Two locks included.
- One height-adjustable shelf included.
- Optional e-lock available in the vertical position for the file drawer. Please specify V - Vertical and add \$304 list.
- Optional e-lock available in the horizontal position. Please specify HR - Horizontal Right and add \$304 list.

PRODUCT CODE	FINISH LP	B	W	SIZE/INCHES				D	WEIGHT LBS	VOL FT <sup>3</sup>
				H (LP/B)	H (W)	W	D			
L2CR2DBF2060	2662	2778	2936	19.94	20.5	60	20	214	20	
L2CR2DBF2066	2698	2830	3154	19.94	20.5	66	20	224	22	
L2CR2DBF2072	2840	3087	3221	19.94	20.5	72	20	235	24	
L2CR2DBF2460	2770	2889	3051	19.94	20.5	60	24	214	20	
L2CR2DBF2466	2806	2945	3280	19.94	20.5	66	24	224	22	
L2CR2DBF2472	2954	3211	3351	19.94	20.5	72	24	235	24	

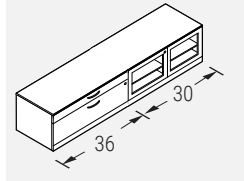
**L2CRBF2AD • Credenza, Box/File / 2 Aluminum Door**

- Two locks included.
- One height-adjustable shelf included.
- Door frame is anodized aluminum.
- Glazing is frosted acrylic.
- Doors standard with no handles.
- Optional e-lock available in the vertical position. Please specify V - Vertical and add \$304 list.
- E-locks not available for aluminum-framed glass doors.

PRODUCT CODE	FINISH LP	B	W	SIZE/INCHES				D	WEIGHT LBS	VOL FT <sup>3</sup>
				H (LP/B)	H (W)	W	D			
L2CRBF2AD2060	3282	3396	3555	19.94	20.5	60	20	214	20	
L2CRBF2AD2066	3368	3503	3825	19.94	20.5	66	20	224	22	
L2CRBF2AD2072	3512	3758	3892	19.94	20.5	72	20	235	24	
L2CRBF2AD2460	3412	3530	3696	19.94	20.5	60	24	214	20	
L2CRBF2AD2466	3504	3642	3979	19.94	20.5	66	24	224	22	
L2CRBF2AD2472	3652	3908	4048	19.94	20.5	72	24	235	24	

**L2CR2ADBF • Credenza, 2 Aluminum Doors / Box/File**

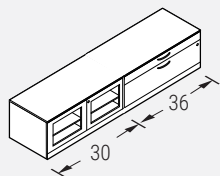

- Two locks included.
- One height-adjustable shelf included.
- Door frame is anodized aluminum.
- Glazing is frosted acrylic.
- Doors standard with no handles.
- Optional e-lock available in the vertical position. Please specify V - Vertical and add \$304 list.
- E-locks not available for aluminum-framed glass doors.

PRODUCT CODE	FINISH			SIZE / INCHES				WEIGHT		VOL FT <sup>3</sup>
	LP	B	W	H (LP/B)	H (W)	W	D	LBS		
L2CR2ADBF2060	3282	3396	3555	19.94	20.5	60	20	214	20	
L2CR2ADBF2066	3368	3503	3825	19.94	20.5	66	20	224	22	
L2CR2ADBF2072	3512	3758	3892	19.94	20.5	72	20	235	24	
L2CR2ADBF2460	3412	3530	3696	19.94	20.5	60	24	214	20	
L2CR2ADBF2466	3504	3642	3979	19.94	20.5	66	24	224	22	
L2CR2ADBF2472	3652	3908	4048	19.94	20.5	72	24	235	24	

**L2CR2H2D • Credenza, 2-High File / 2 Doors**

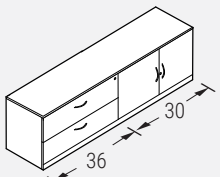

- Two locks included.
- Optional e-lock available in the vertical position for the file drawer. Please specify V - Vertical and add \$304 list.
- Optional e-lock available in the horizontal position. Please specify HR - Horizontal Right and add \$304 list.

PRODUCT CODE	FINISH			SIZE / INCHES				WEIGHT		VOL FT <sup>3</sup>
	LP	B	W	H (LP/B)	H (W)	W	D	LBS		
L2CR2H2D2060	2949	3151	3249	29	29.5	60	20	363	24	
L2CR2H2D2066	3071	3282	3388	29	29.5	66	20	374	26	
L2CR2H2D2072	3200	3394	3534	29	29.5	72	20	396	30	
L2CR2H2D2460	3066	3276	3380	29	29.5	60	24	363	24	
L2CR2H2D2466	3193	3413	3525	29	29.5	66	24	374	26	
L2CR2H2D2472	3328	3526	3675	29	29.5	72	24	396	30	

**L2CR2D2H • Credenza, 2 Doors / 2-High File**

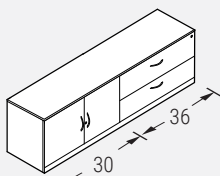

- Two locks included.
- Optional e-lock available in the vertical position for the file drawer. Please specify V - Vertical and add \$304 list.
- Optional e-lock available in the horizontal position. Please specify HR - Horizontal Right and add \$304 list.

PRODUCT CODE	FINISH			SIZE / INCHES				WEIGHT		VOL FT <sup>3</sup>
	LP	B	W	H (LP/B)	H (W)	W	D	LBS		
L2CR2D2H2060	2949	3151	3249	29	29.5	60	20	363	24	
L2CR2D2H2066	3071	3282	3388	29	29.5	66	20	374	26	
L2CR2D2H2072	3200	3394	3534	29	29.5	72	20	396	30	
L2CR2D2H2460	3066	3276	3380	29	29.5	60	24	363	24	
L2CR2D2H2466	3193	3413	3525	29	29.5	66	24	374	26	
L2CR2D2H2472	3328	3526	3675	29	29.5	72	24	396	30	

**L2CR2H2H • Credenza, 2-High File/File**

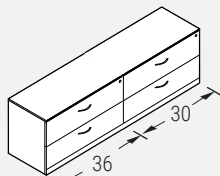

- Two locks included.
- Optional e-lock available in the vertical position. Please specify V - Vertical and add \$304 list.
- Credenzas require two e-locks.

PRODUCT CODE	FINISH			SIZE / INCHES				WEIGHT		VOL FT <sup>3</sup>
	LP	B	W	H (LP/B)	H (W)	W	D	LBS		
L2CR2H2H2060	3420	3539	3666	29	29.5	60	20	385	24	
L2CR2H2H2066	3540	3671	3804	29	29.5	66	20	407	26	
L2CR2H2H2072	3660	3803	3945	29	29.5	72	20	418	30	
L2CR2H2H2460	3556	3679	3812	29	29.5	60	24	385	24	
L2CR2H2H2466	3680	3819	3956	29	29.5	66	24	407	26	
L2CR2H2H2472	3806	3956	4102	29	29.5	72	24	418	30	

**L2CR2D2D • Credenza, 2-High 4 Doors**

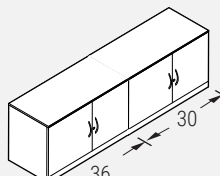

- Two locks included.
- Optional e-lock available in the horizontal position. Please specify HR - Horizontal Right and add \$304 list.
- Credenzas require two e-locks.

PRODUCT CODE	FINISH			SIZE / INCHES				WEIGHT		VOL FT <sup>3</sup>
	LP	B	W	H (LP/B)	H (W)	W	D	LBS		
L2CR2D2D2060	2486	2769	2841	29	29.5	60	20	341	24	
L2CR2D2D2066	2614	2878	2988	29	29.5	66	20	352	26	
L2CR2D2D2072	2747	2989	3131	29	29.5	72	20	363	30	
L2CR2D2D2460	2584	2880	2954	29	29.5	60	24	341	24	
L2CR2D2D2466	2722	2995	3108	29	29.5	66	24	352	26	
L2CR2D2D2472	2859	3109	3255	29	29.5	72	24	363	30	

**L2CR4AD • Credenza, 2-High 4 Aluminum Doors**

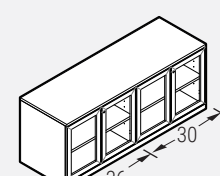

- Two locks included.
- Door frame is anodized aluminum.
- Glazing is frosted acrylic.
- Doors standard with no handles.
- E-lock not available for aluminum-framed glass doors.

PRODUCT CODE	FINISH			SIZE / INCHES				WEIGHT		VOL FT <sup>3</sup>
	LP	B	W	H (LP/B)	H (W)	W	D	LBS		
L2CR4AD2060	4060	4348	4425	29	29.5	60	20	336	24	
L2CR4AD2066	4336	4603	4713	29	29.5	66	20	347	26	
L2CR4AD2072	4616	4861	5008	29	29.5	72	20	358	30	
L2CR4AD2460	4161	4462	4538	29	29.5	60	24	336	24	
L2CR4AD2466	4443	4721	4836	29	29.5	66	24	347	26	
L2CR4AD2472	4729	4983	5133	29	29.5	72	24	358	30	

**LPSTC/LLSTC • Pedestal/Lateral Seat Cushion**

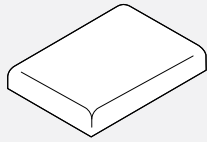

PRODUCT CODE	YRDS	SIZE/INCHES			WEIGHT VOL	
		H	W	D	LBS	FT <sup>3</sup>
LPSTC1518	0.75	2	15.5	18	2	0.34
LPSTC1520	0.75	2	15.5	20	2	0.40
LPSTC1523	0.75	2	15.5	23	3	0.44
LPSTC1524	0.75	2	15.5	24	3	0.46
LPSTC1529	1.00	2	15.5	29	3	0.55
LPSTC1530	1.00	2	15.5	30	3	0.24
LLSTC2030	1.00	2	20	30	5	0.76
LLSTC2036	1.25	2	20	36	6	0.91
LLSTC2230	1.00	2	22	30	6	0.84
LLSTC2236	1.25	2	22	36	7	1.01
LLSTC2430	1.00	2	24	30	6	0.91
LLSTC2436	1.25	2	24	36	7	1.10

PRODUCT CODE	PRICE									
	GR1	GR2	GR3	GR4	GR5	GR6	GR7	GR8	GR9	GR10
LPSTC1518	321	353	392	449	504	560	607	666	723	799
LPSTC1520	328	361	399	458	513	567	616	673	732	807
LPSTC1523	336	367	406	465	519	575	623	679	738	813
LPSTC1524	346	376	414	473	529	582	630	688	746	822
LPSTC1529	425	467	517	594	669	739	807	881	959	1059
LPSTC1530	434	474	525	603	676	748	815	889	966	1067
LLSTC2030	456	498	548	626	700	770	838	913	990	1091
LLSTC2036	544	598	660	758	849	939	1021	1115	1212	1338
LLSTC2230	461	504	555	632	707	785	845	919	997	1098
LLSTC2236	552	71	669	765	856	947	1029	1126	1222	1348
LLSTC2430	467	508	560	637	712	782	817	922	1002	1102
LLSTC2436	562	613	676	774	865	958	1039	1134	1229	1357

**LACWB • Counterweight Balance for use in Licence Storage Units**

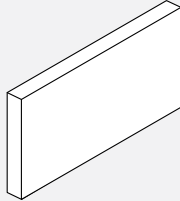

PRODUCT CODE	PRICE	SIZE/INCHES			WEIGHT VOL	
		H	W	D	LBS	FT <sup>3</sup>
LACWB	123	0.5	11.62	11.62	10	0.07

**BHTP01 • Bracket to Connect Licence Towers to Boulevard Panels**

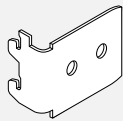

Panel Frame Finish

PRODUCT CODE	PRICE	SIZE/INCHES			WEIGHT VOL	
		H	W	D	LBS	FT <sup>3</sup>
BHTP01	111	2	2.5	1	2	0.05

**L2PO • Pantry Storage**



Left Hand Shown

- The pull out cabinet serves as a multifunction, customizable storage unit that both defines space and enhances privacy in an open plan environment.
- Can be used in conjunction with Licence, FreeFit and Boulevard.
- Internal organization consists of two fixed shelves top and bottom. The two middle shelves are adjustable. Two accessory rails are standard and will accept GC metal accessories
- Interior cabinet shelves and back are standard in Designer White. Cabinet shell, drawer and top can be specified in any standard laminate.
- L2PO-NL/R does not fit binders.
- Only available with FA handle.

**Finish**

While the Pantry Storage cabinet walls, top and pull-out drawer front door and back panel finish can be specified, The internal cabinet back and adjustable shelves are standard white. Please specify the cabinet top and pull-out drawer front finish.

**Options**

- Dual USB outlet kit - please add "USB" at the end of the code. Add \$512 to the list price
- When you specify dual USB outlet the top shelf will come with grey felt surface and grommet which allows for cable passage from the USB outlet (located below the top shelf). A two-prong power cord exits the cabinet through the floor at the back.
- Dry-erase marker board - Choose "DE" option. Please add \$361 to the list price. If specified the Dry-erase marker laminate will be applied to the external surface of the pull-out drawer side wall.

PRODUCT CODE	PRICE LP	SIZE/INCHES			H(LP/B)	H(W)	W	D	WEIGHT LBS	VOL FT <sup>3</sup>
		B	W	D						
L2PO1224H42NL	2179	2205	2254	41.56	42	12	24	128	7	
L2PO1230H42NL	2287	2320	2380	41.56	42	12	30	143	9	
L2PO1236H42NL	2395	2433	2505	41.56	42	12	36	157	11	
L2PO1824H42NL	2504	2543	2611	41.56	42	18	24	156	11	
L2PO1830H42NL	2624	2674	2755	41.56	42	18	30	172	13	
L2PO1836H42NL	2745	2803	2900	41.56	42	18	36	187	16	
L2PO1224NL	2369	2393	2439	49.56	50	12	24	133	8	
L2PO1230NL	2483	2529	2568	49.56	50	12	30	148	10	
L2PO1236NL	2599	2665	2700	49.56	50	12	36	162	15	
L2PO1824NL	2751	2798	2846	49.56	50	18	24	161	12	
L2PO1830NL	2873	2950	2992	49.56	50	18	30	177	15	
L2PO1836NL	2998	3101	3136	49.56	50	18	36	192	18	
L2PO1224H54NL	2397	2420	2465	53.56	54	12	24	138	9	
L2PO1230H54NL	2510	2539	2568	53.56	54	12	30	153	11	
L2PO1236H54NL	2624	2660	2699	53.56	54	12	36	167	14	
L2PO1824H54NL	2779	2814	2875	53.56	54	18	24	166	14	
L2PO1830H54NL	2902	2947	3019	53.56	54	18	30	182	17	
L2PO1836H54NL	3027	3078	3163	53.56	54	18	36	197	20	
L2PO1224H42NR	2179	2205	2254	41.56	42	12	24	128	7	
L2PO1230H42NR	2287	2320	2380	41.56	42	12	30	143	9	
L2PO1236H42NR	2395	2433	2505	41.56	42	12	36	157	11	
L2PO1824H42NR	2504	2543	2611	41.56	42	18	24	156	11	
L2PO1830H42NR	2624	2674	2755	41.56	42	18	30	172	13	
L2PO1836H42NR	2745	2803	2900	41.56	42	18	36	187	16	
L2PO1224NR	2369	2393	2439	49.56	50	12	24	133	8	
L2PO1230NR	2483	2529	2568	49.56	50	12	30	148	10	
L2PO1236NR	2599	2665	2700	49.56	50	12	36	162	15	
L2PO1824NR	2751	2798	2846	49.56	50	18	24	161	12	
L2PO1830NR	2873	2950	2992	49.56	50	18	30	177	15	
L2PO1836NR	2998	3101	3136	49.56	50	18	36	192	18	
L2PO1224H54NR	2397	2420	2465	53.56	54	12	24	138	9	
L2PO1230H54NR	2510	2539	2568	53.56	54	12	30	153	11	
L2PO1236H54NR	2624	2660	2699	53.56	54	12	36	167	14	
L2PO1824H54NR	2779	2814	2875	53.56	54	18	24	166	14	
L2PO1830H54NR	2902	2947	3019	53.56	54	18	30	182	17	
L2PO1836H54NR	3027	3078	3163	53.56	54	18	36	197	20	

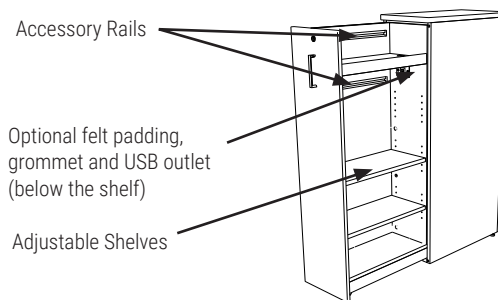
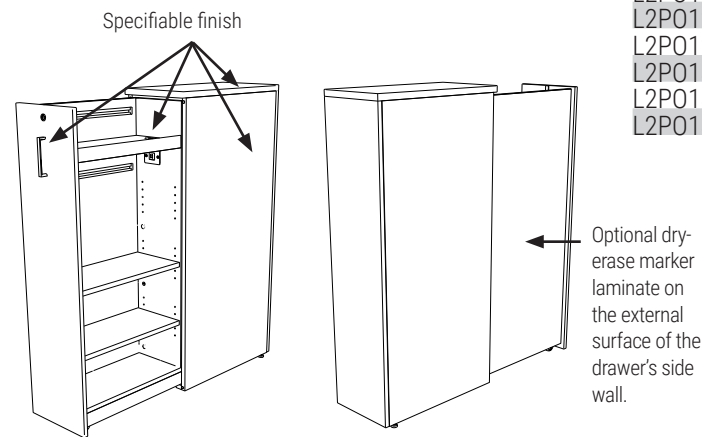

**Integrated Accessory rails**

Two accessory rails (each 18.25" long) are provided to further enhance customization with Teknion metal accessories.

Upper Accessory Rail:

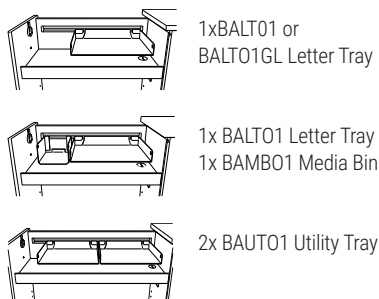

Lower Accessory Rail:

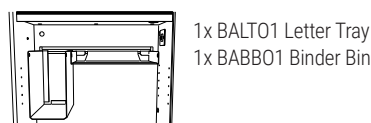
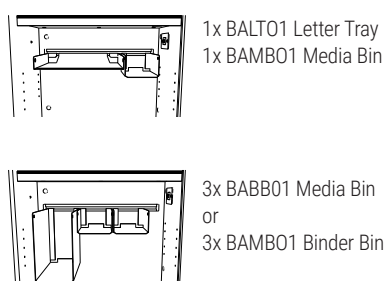

L2PW • Pantry Storage

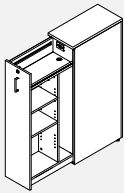

Left Hand Shown

- The pull out cabinet serves as a multifunction, customizable storage unit that both defines space and enhances privacy in an open plan environment.
- Can be used in conjunction with Licence, FreeFit and Boulevard.
- Internal organization consists of two fixed shelves top and bottom. The two middle shelves are adjustable. Two accessory rails are standard and will accept GC metal accessories
- Interior cabinet shelves and back are standard in Designer White. Cabinet shell, drawer and top can be specified in any standard laminate.
- L2P0-NL/R does not fit binders.
- Only available with FA handle.

**Finish**

While the Pantry Storage cabinet walls, top and pull-out drawer front door and back panel finish can be specified, The internal cabinet back and adjustable shelves are standard white. Please specify the cabinet top and pull-out drawer front finish.

**Options**

- Dual USB outlet kit - please add "USB" at the end of the code. Add \$512 to the list price
- When you specify dual USB outlet the top shelf will come with grey felt surface and grommet which allows for cable passage from the USB outlet (located below the top shelf). A two-prong power cord exits the cabinet through the floor at the back.
- Dry-erase marker board - Choose "DE" option. Please add \$361 to the list price. If specified the Dry-erase marker laminate will be applied to the external surface of the pull-out drawer side wall.

PRODUCT CODE	PRICE			SIZE/INCHES				WEIGHT LBS	VOL FT³
	LP	B	W	H(LP/B)	H(W)	W	D		
L2PW1224H42NL	2447	2474	2526	41.56	42	12	24	128	7
L2PW1230H42NL	2559	2592	2654	41.56	42	12	30	143	9
L2PW1236H42NL	2669	2709	2783	41.56	42	12	36	157	11
L2PW1824H42NL	2834	2876	2945	41.56	42	18	24	156	11
L2PW1830H42NL	2958	3009	3093	41.56	42	18	30	172	13
L2PW1836H42NL	3081	3143	3240	41.56	42	18	36	187	16
L2PW1224NL	2667	2691	2738	49.56	50	12	24	133	8
L2PW1230NL	2784	2832	2871	49.56	50	12	30	148	10
L2PW1236NL	2903	2972	3006	49.56	50	12	36	162	15
L2PW1824NL	3117	3165	3215	49.56	50	18	24	161	12
L2PW1830NL	3243	3323	3365	49.56	50	18	30	177	15
L2PW1836NL	3372	3477	3513	49.56	50	18	36	192	18
L2PW1224H54NL	2718	2744	2790	53.56	54	12	24	138	9
L2PW1230H54NL	2835	2865	2895	53.56	54	12	30	153	11
L2PW1236H54NL	2954	2990	3029	53.56	54	12	36	167	14
L2PW1824H54NL	3177	3213	3276	53.56	54	18	24	166	14
L2PW1830H54NL	3305	3351	3425	53.56	54	18	30	182	17
L2PW1836H54NL	3434	3486	3573	53.56	54	18	36	197	20
L2PW1224H42NR	2447	2474	2526	41.56	42	12	24	128	7
L2PW1230H42NR	2559	2592	2654	41.56	42	12	30	143	9
L2PW1236H42NR	2669	2709	2783	41.56	42	12	36	157	11
L2PW1824H42NR	2834	2876	2945	41.56	42	18	24	156	11
L2PW1830H42NR	2958	3009	3093	41.56	42	18	30	172	13
L2PW1836H42NR	3081	3143	3240	41.56	42	18	36	187	16
L2PW1224NR	2667	2691	2738	49.56	50	12	24	133	8
L2PW1230NR	2784	2832	2871	49.56	50	12	30	148	10
L2PW1236NR	2903	2972	3006	49.56	50	12	36	162	15
L2PW1824NR	3117	3165	3215	49.56	50	18	24	161	12
L2PW1830NR	3243	3323	3365	49.56	50	18	30	177	15
L2PW1836NR	3372	3477	3513	49.56	50	18	36	192	18
L2PW1224H54NR	2718	2744	2790	53.56	54	12	24	138	9
L2PW1230H54NR	2835	2865	2895	53.56	54	12	30	153	11
L2PW1236H54NR	2954	2990	3029	53.56	54	12	36	167	14
L2PW1824H54NR	3177	3213	3276	53.56	54	18	24	166	14
L2PW1830H54NR	3305	3351	3425	53.56	54	18	30	182	17
L2PW1836H54NR	3434	3486	3573	53.56	54	18	36	197	20

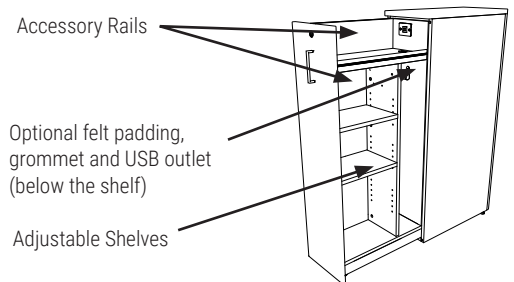
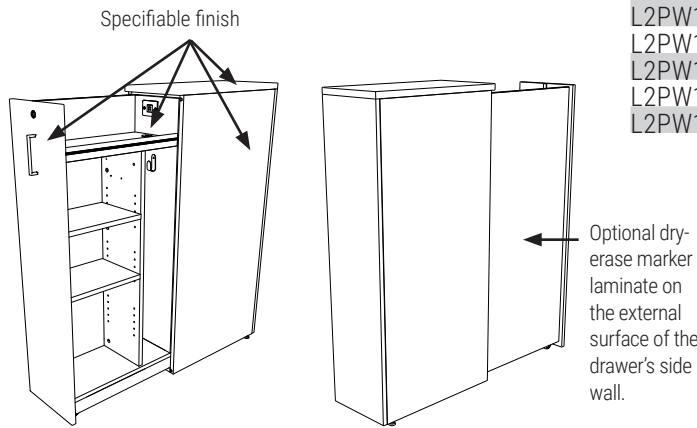

**Integrated Accessory rails**

Two accessory rails (each 18.25" long) are provided to further enhance customization with Teknion metal accessories.

Upper Accessory Rail:

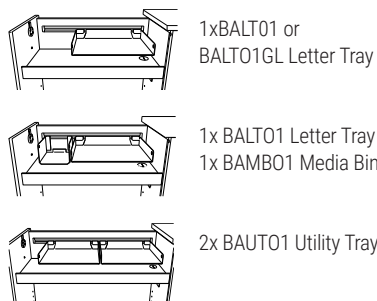

Lower Accessory Rail:

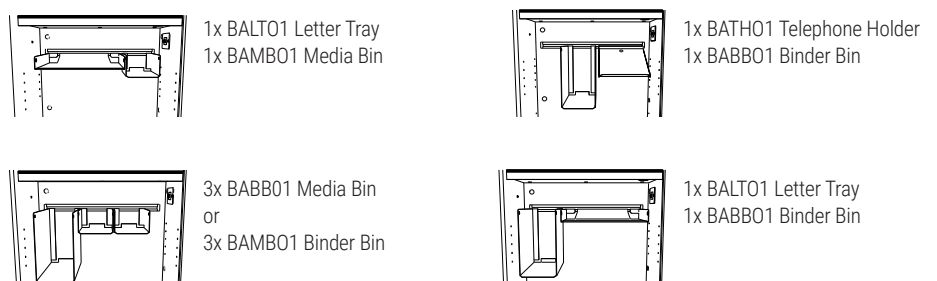

**TECHNICAL INFORMATION - TABLES**

**Tables**

- All table surfaces are High Pressure Laminate in "B" or "W" thickness.
- All tables have "T" mold edge band, unless otherwise indicated.
- Tables up to and including 96" long are manufactured in one piece, 120" to 192" long are manufactured in two pieces and over 216" are manufactured in three pieces. If wood grain laminate is chosen, the wood grain pattern will not line up.
- Tables in 2 or 3 pieces will have the joining edge finished with PVC edge (0.5mm), hardware will be shipped for assembly.
- Power modules and grommets are not included, they must be specified separately.
- Grommet locations must be specified at the time of order or it will default to "no grommet" option.
- Positions for drop in power and data grommets are intended for use on tops with the following bases: LR, LSQ, LDRUM, TELRS, TELRR, TELBS, TELBR. For any other base, please consult Customer Service Representative.
- Tables are not pre-drilled to accept legs or bases.
- "LTR" Rectangular shape tables with edge B and W have a 1" radius at each corner.
- For table tops with square corners, please add "NR" at the end of the product code, no upcharge required. The "NR" option is available only with the B and W edge profiles.
- "LBT" Boat shape tables are 6" narrower at the ends. The nominal size is identified at the center.
- "LBTB" Boat shape tables with bow ends are 12" narrower at the ends. The nominal size is identified at the center.
- Trapezoid tables can be used in several combinations.

**Bases**

- Available in variety of materials metal, high pressure laminate or low pressure laminate, please refer to specific base in price list
- "LR" Rectangular and "LSQ" square bases come standard with removable access door and cut out on the bottom of the base for pass-thru cables.
- "TELRS / TELBS" square and "TELRR / TELBR" rectangular bases come standard with cut out on the bottom of the base for pass-thru cables. Hinged access doors are optional and must be specified with an "HD" at the end of the code. There will be an upcharge of \$83 to the list price.
- Drum bases are finished in high pressure only and comes with a full bottom and notch at the top. Sand bag included. Access door is not an option.
- Drum, rectangular and square bases are shipped assembled.

**Folding Legs**

- Legs are folded by pressing the lever. Once folded, the legs are held securely by the interlocking springs.
- Includes adjustable levelers offering 12mm (1/2") of adjustment.
- Minimum special sizing for tables is 54" in length and 25" in depth.
- Sold per pair.

**Flip-Top Training Tables**

- "GFT" Rectangular Flip tables with edge B and W edge have straight corners.

**Visual Board**

- Unit offered in high pressure laminate (B) comes with 2 high pressure laminate doors
- Cork board included on one inside door.
- Unit closes with a touch latch mechanism, but no lock option.
- "MG" indicates a magnetic white board.

**TABLES • GUIDELINES FOR ORDERING PRODUCT**

**CODES:** The price list uses a numbering system with meaningful alphanumeric characters to create a simple-to-understand product number. This makes specifying the product much easier and more accurate.

**SPECIFICATION EXAMPLE OF A TABLE UNIT**

**PRODUCT CODE:** LTS2424  
 L = Licence  
 T = Table  
 S = Square  
 2424 = Size: Depth x Width

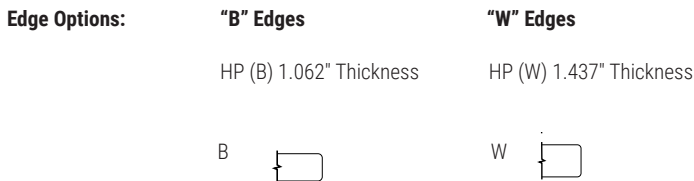

## BASE SPECIFICATION GUIDE (SEE INSTALLATION MANUAL FOR EXAMPLES)

- Tables up to 96" in length require 2 T bases
- Tables 108" to 144" in length require 3 T bases
- Tables 156" to 192" in length require 4 T bases
- Tables 216" to 240" in length require 6 T bases

### FLAT BAR 3-PRONG "TTFL"

BASE SPREAD	TOP WIDTH
18"	24W
22"	30W
24"	36W
30"	42W
36"	48W
36"	54W

### LLT/LLTT W/BULLNOSE ENDS

BASE SPREAD	TOP WIDTH
18"	24W
26"	30W
26"	36W
30"	42W
36"	48W
36"	54W
42"	60W

### TTFLT FLAT BAR "T"

BASE SPREAD	TOP WIDTH
18"	24W
22"	30W
24"	36W
30"	42W
36"	48W
36"	54W

### LD DRUM

BASE SPREAD	ROUND TOP SIZE
18" dia	30" dia
18" dia	36" dia
24" dia	42" dia
24" dia	48" dia
30" dia	54" dia
30" dia	60" dia

### LSQ, TELRS & TELBS SQUARE

BASE SPREAD	TOP SIZE
18"	30x30
18"	36x36
24"	42x42
24"	48x48
30"	54x54
30"	60x60

### LCT CROSS BASE

BASE SPREAD	TOP SIZE
18"	24x24
24"	30x30
24"	36x36
30"	42x42
30"	48x48
36"	54x54
42"	60x60

- 1 Piece Tables up to 96" in length require 2 bases
- Tables 108" to 192" in length require 3 bases
- Tables 216" to 240" in length require 4 bases

### LR, LSQ, TELRS, TELRR, TELBS, TELBR

BASE SPREAD	TOP WIDTH
18"	30
18"	36
24"	42
24"	48
30"	54
30"	60

### LELBA

BASE SPREAD	TOP WIDTH
18"	30
18"	36
24"	42
30"	48
36"	54
36"	60

### TRUMPET 28H

BASE SPREAD	TOP SIZE
18"	24x24
24"	30x30
24"	36x36
30"	42x42
30"	48x48

### FLAT SQUARE

BASE SPREAD	TOP SIZE
18"	24x24
18"	30x30
23"	36x36
23"	42x42
30"	48x48

### FLAT DISC 28H

BASE SPREAD	TOP SIZE
18"	24x24
18"	30x30
24"	36x36
30"	42x42
30"	48x48
36"	54x54

### FLATBAR X

BASE SPREAD	TOP SIZE
18"	24x24
18"	30x30
24"	36x36
24"	42x42
30"	48x48
36"	54x54

### TRUMPET 40.5H

BASE SPREAD	TOP SIZE
18"	24x24
24"	30x30
24"	36x36

### FLAT SQUARE 40.5H

BASE SPREAD	TOP SIZE
18"	24x24
23"	30x30

### FLAT DISC 40.5H

BASE SPREAD	TOP SIZE
18"	24x24
22"	30x30
24"	36x36

### FLATBAR X 40.5H

BASE SPREAD	TOP SIZE
18"	24x24
22"	30x30

### LL4S W/BULLNOSE ENDS

BASE SPREAD	TOP SIZE
18"	24x24
26"	30x30
26"	36x36
26"	42x42
30"	48x48
36"	54x54

### LHC HAT CHANNEL

LHC40	For Table 54" Wide
LHC46	For Table 60" Wide
LHC52	For Table 66" Wide
LHC58	For Table 72" Wide
LHC64	For Table 78" Wide
LHC70	For Table 84" Wide

### LL4S W/BULLNOSE ENDS 40.5H

BASE SPREAD	TOP SIZE
26"	30x30
30"	36x36
36"	42x42

Tops with post legs must be specified with HAT Channels for structural reinforcement.

**GROMMET CUT DIMENSIONS (INCHES)**

**BG5**

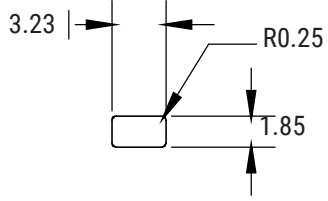
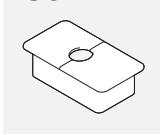

**MSPDM**

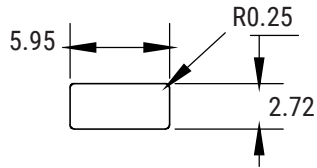
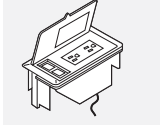

**GAAD**

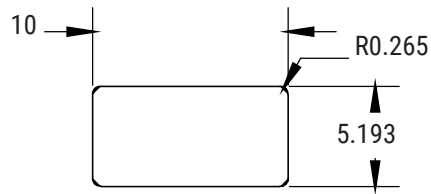
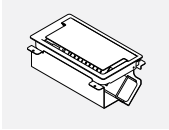

**GCRTMCS4xx**

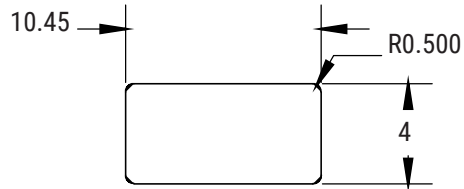
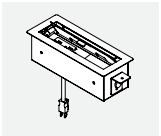

**GCRTMCS6xx**

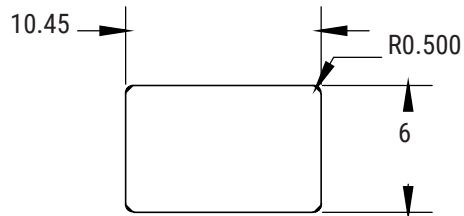
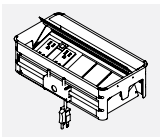



## TABLE DIMENSION CHART AND GROMMET LOCATION

LELBA - Elliptical Base

For One Piece Top

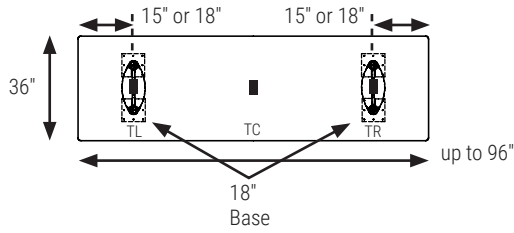

LELBA BASE SPREAD	TOP WIDTH
18"	30
18"	36
24"	42
30"	48
36"	54
36"	60

\*15" for table widths between 60" and 72" and 18" for table widths between 78" and 96"

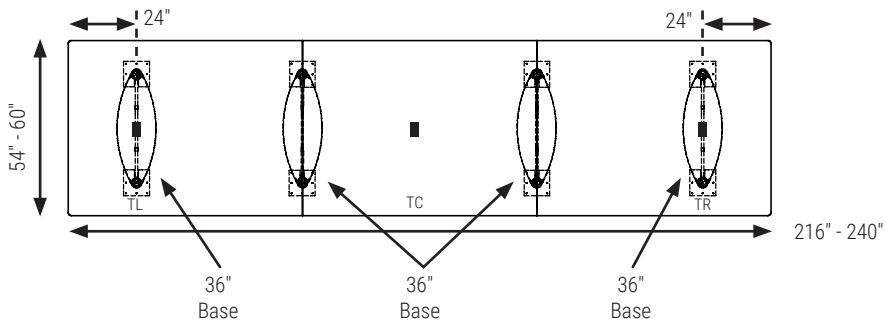
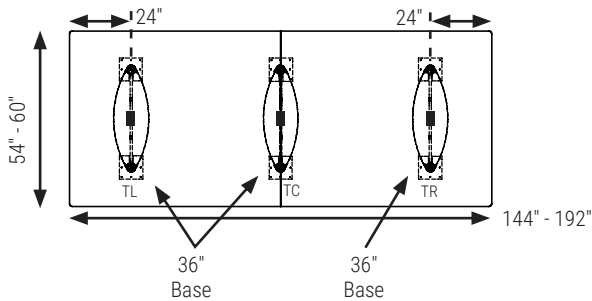
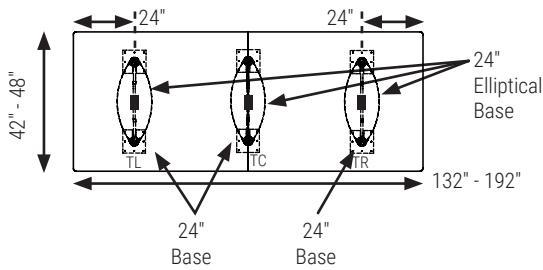
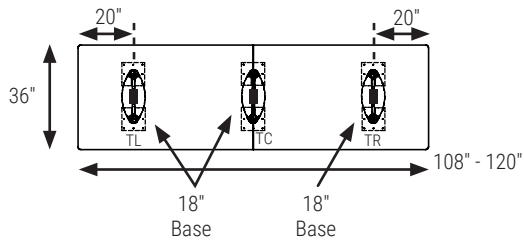

Note: Grommet orientation is perpendicular to the length of table.

**TABLE DIMENSION CHART AND GROMMET LOCATION**

LR - Rectangular Base

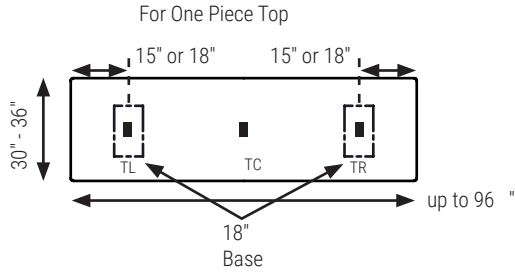

\*15" for table widths between 60" and 72" and 18" for table widths between 78" and 96"

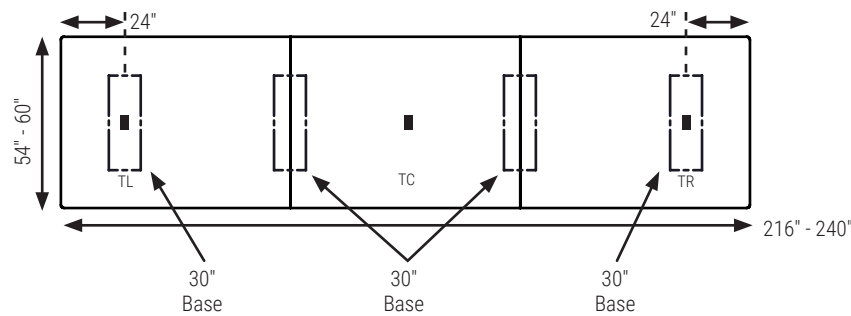
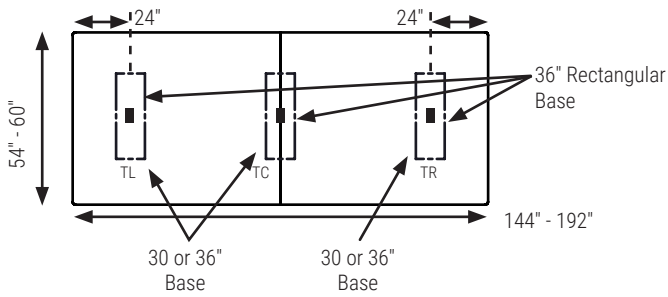
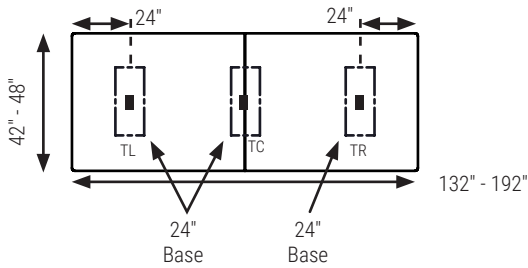
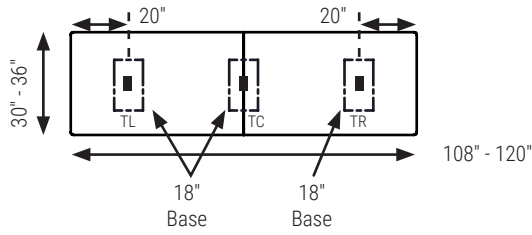

Note: Grommet orientation is perpendicular to the length of table.

TABLE DIMENSION CHART AND GROMMET LOCATION

For One Piece Top

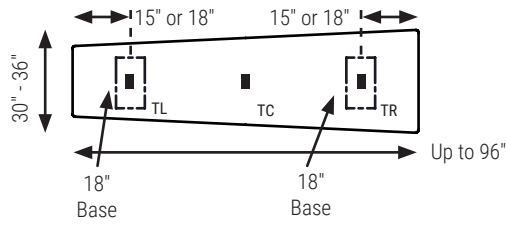

\*15" for table widths between 60" and 72" and 18" for table widths between 78" and 96"

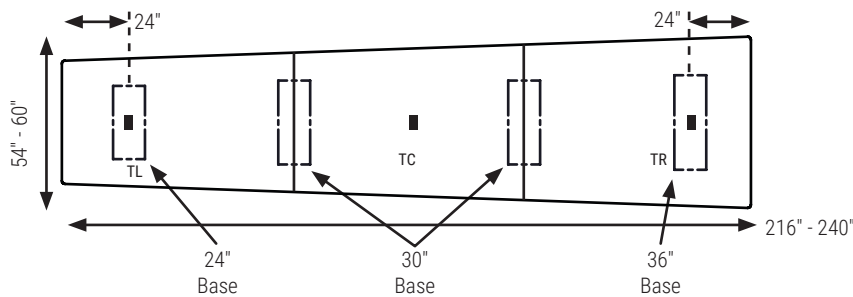
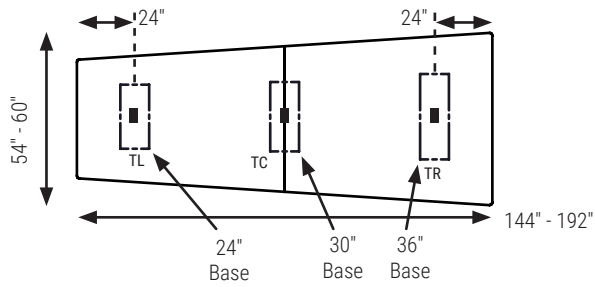
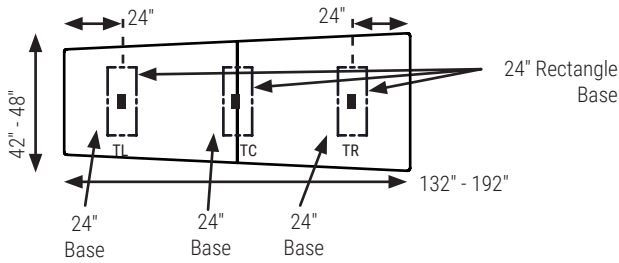
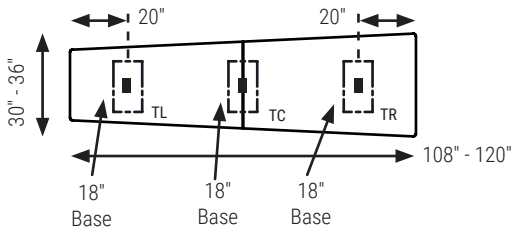

Note: Grommet orientation is perpendicular to the length of table.

**TABLE DIMENSION CHART AND GROMMET LOCATION**

LELBA - Elliptical Base

For One Piece Top

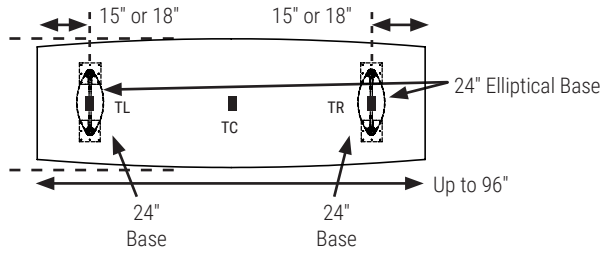

\*15" for table widths between 60" and 72" and 18" for table widths between 78" and 96"

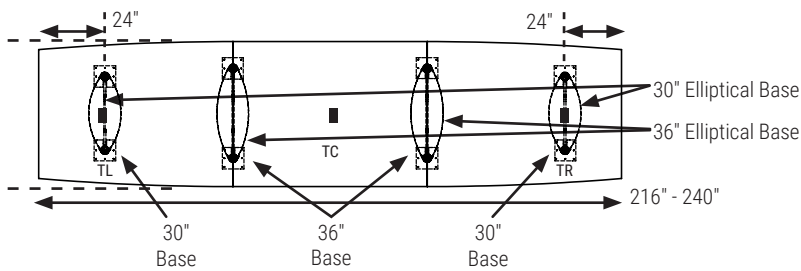
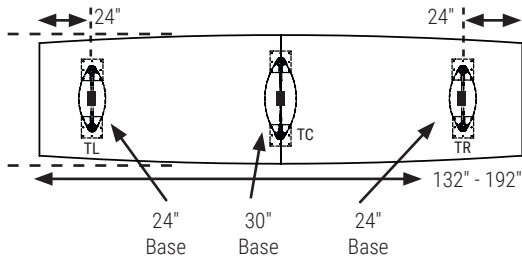
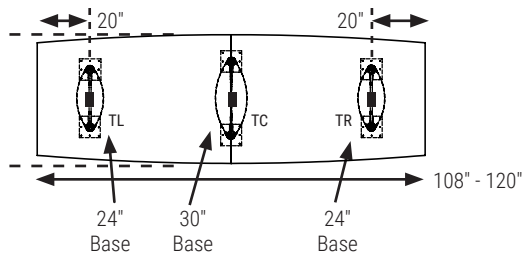

Note: Grommet orientation is perpendicular to the length of table.

**TABLE DIMENSION CHART AND GROMMET LOCATION**

LELBA - Rectangular Base

For One Piece Top

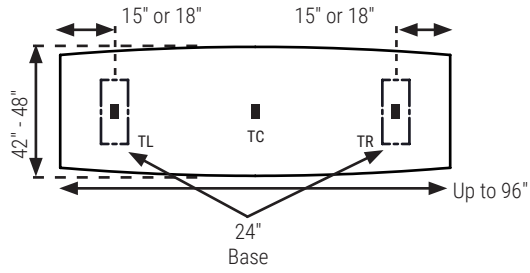

\*15" for table widths between 60" and 72" and 18" for table widths between 78" and 96"

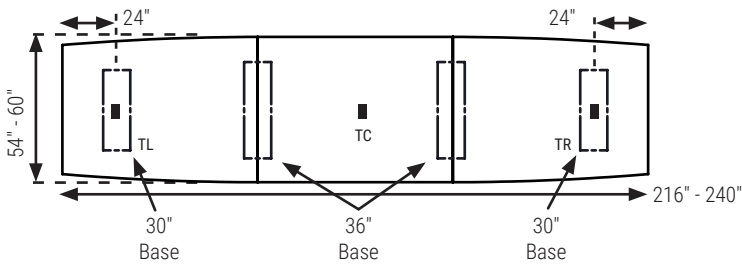
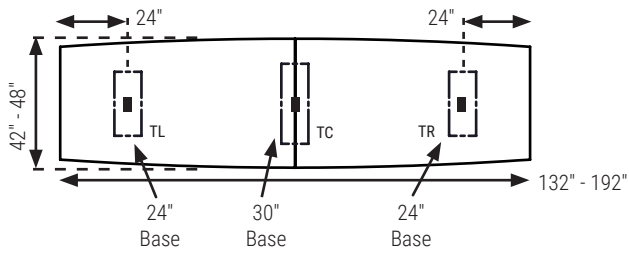
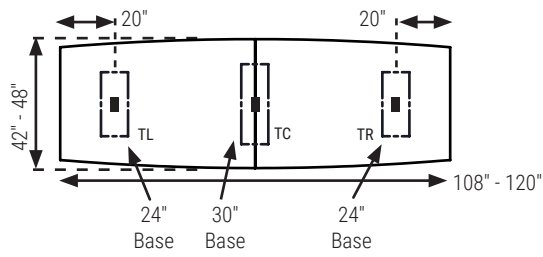

Note: Grommet orientation is perpendicular to the length of table.

**TABLE DIMENSION CHART AND GROMMET LOCATION**

LR - Elliptical Base

For One Piece Top

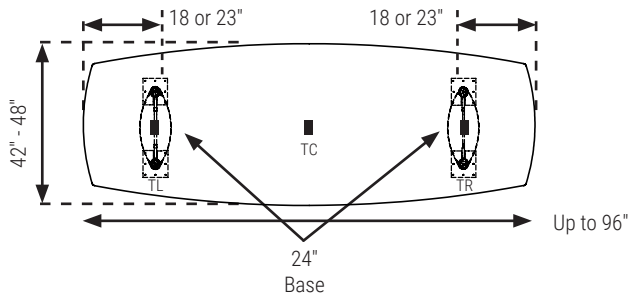

\*18" for table widths between 60" and 72" and 23" for table widths between 78" and 96"

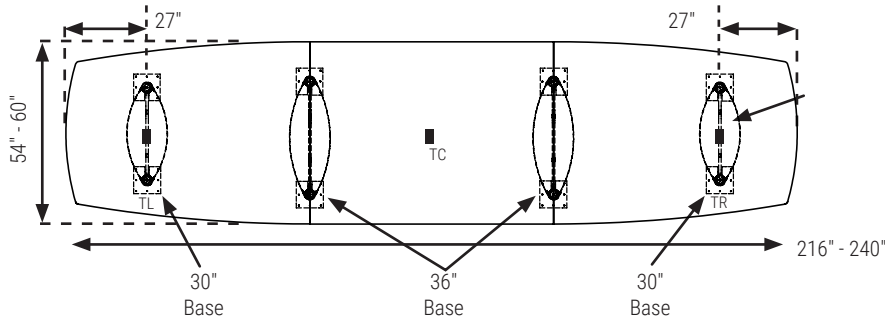
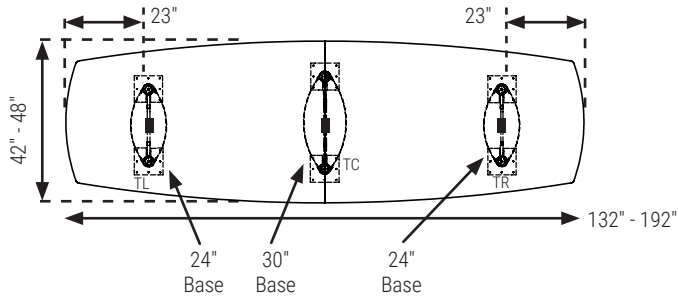
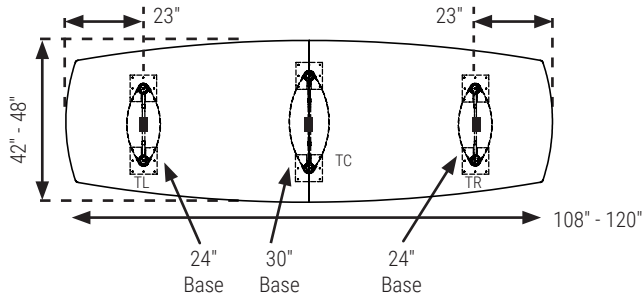

Note: Grommet orientation is perpendicular to the length of table.

**TABLE DIMENSION CHART**

LR - Rectangular Base

For One Piece Top

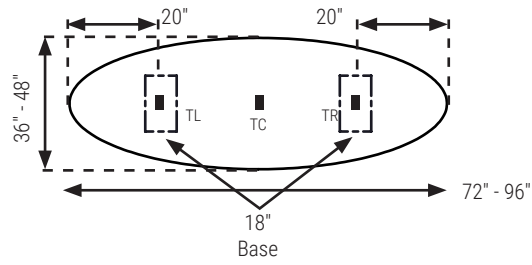

\*15" for table widths between 60" and 72" and 18" for table widths between 78" and 96"

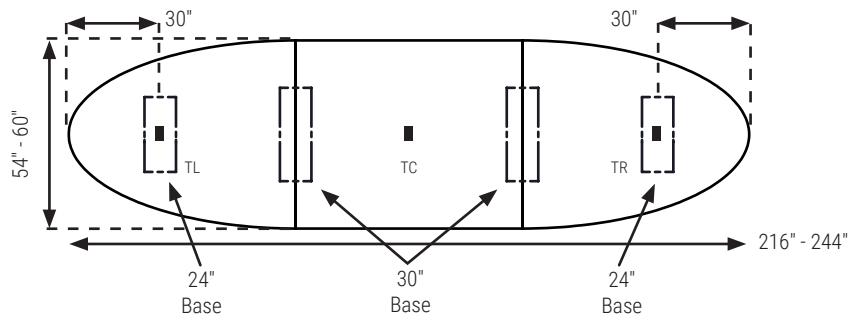
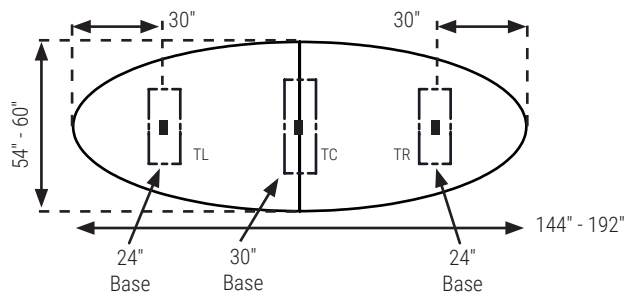
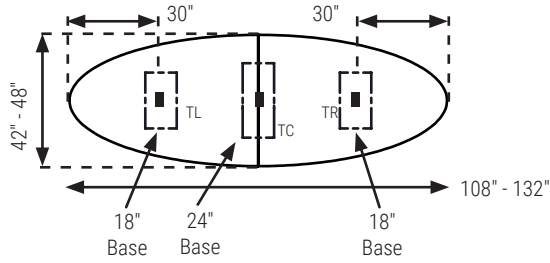

Note: Grommet orientation is perpendicular to the length of table.

**TABLE DIMENSION CHART**

LR - Rectangular Base

For One Piece Top

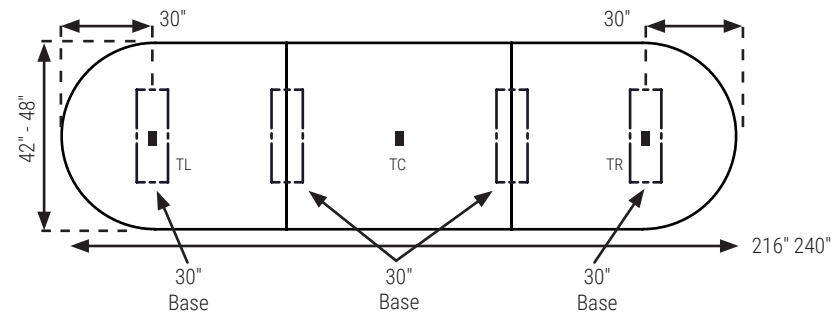
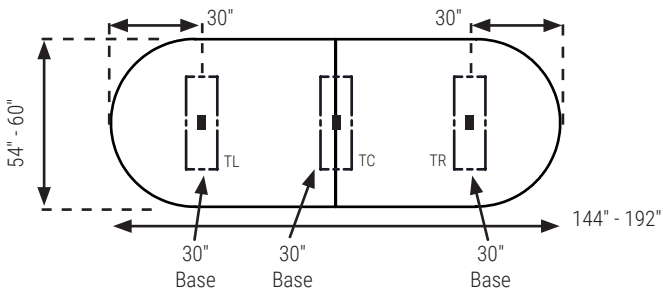
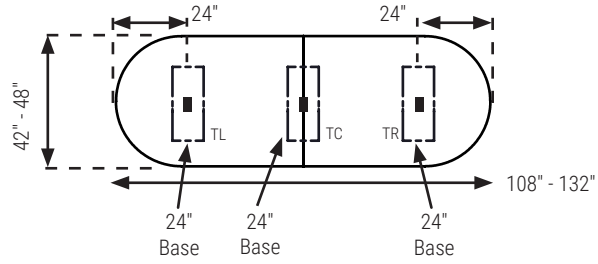
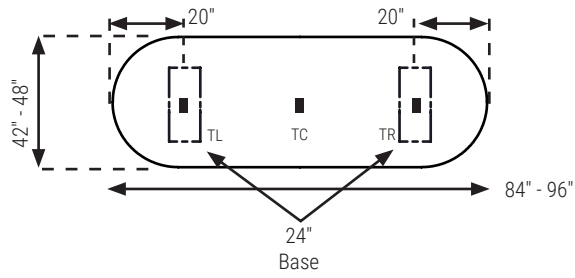

Note: Grommet orientation is perpendicular to the length of table.



**LTS • Square Table Top**

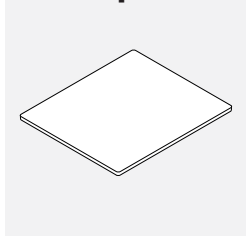

• Tops with Band W thickness have 1" radius corners.

PRODUCT CODE	EDGE		SIZE/INCHES				WEIGHT LBS	VOL FT <sup>3</sup>
	B	W	H(B)	H(W)	W	D		
LTS2424	193	279	1	1.5	24	24	29	3
LTS3030	285	403	1	1.5	30	30	32	3
LTS3636	351	514	1	1.5	36	36	46	4
LTS4242	520	676	1	1.5	42	42	57	6
LTS4848	669	857	1	1.5	48	48	75	7
LTS5454	832	1060	1	1.5	54	54	86	10
LTS6060	1013	1289	1	1.5	60	60	99	12

**L-DIA • Circle Table Top**

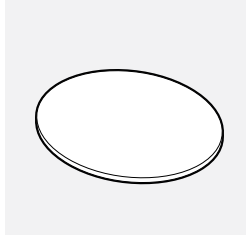

PRODUCT CODE	EDGE		SIZE/INCHES				WEIGHT LBS	VOL FT <sup>3</sup>
	B	W	H(B)	H(W)	W	D		
L24DIA	199	287	1	1.5	24 dia	24 dia	29	3
L30DIA	250	416	1	1.5	30	30	32	3
L36DIA	360	528	1	1.5	36	36	46	4
L42DIA	538	696	1	1.5	42	42	57	6
L48DIA	687	884	1	1.5	48	48	75	7
L54DIA	857	1095	1	1.5	54	54	86	10
L60DIA	1043	1329	1	1.5	60	60	99	12

**LTR • Rectangle Table Top**

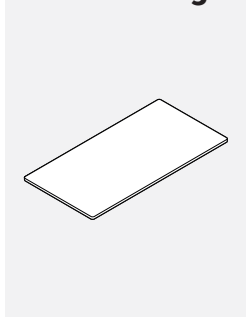

• Tops with B and W thickness have 1" radius corners.

PRODUCT CODE	EDGE		SIZE/INCHES				WEIGHT LBS	VOL FT <sup>3</sup>
	B	W	H(B)	H(W)	W	D		
LTR2430	204	309	1	1.5	30	24	26	2
LTR2436	231	357	1	1.5	36	24	31	2
LTR2442	304	408	1	1.5	42	24	33	3
LTR2448	365	462	1	1.5	48	24	35	3
LTR2454	426	513	1	1.5	54	24	40	3
LTR2460	479	563	1	1.5	60	24	42	4
LTR2466	498	617	1	1.5	66	24	47	4
LTR2472	522	670	1	1.5	72	24	53	4
LTR3036	286	430	1	1.5	36	30	31	2
LTR3042	405	491	1	1.5	42	30	35	2
LTR3048	426	555	1	1.5	48	30	40	3
LTR3054	457	619	1	1.5	54	30	44	3
LTR3060	498	681	1	1.5	60	30	48	3
LTR3066	520	744	1	1.5	66	30	53	3
LTR3072	551	806	1	1.5	72	30	57	3
LTR3078	582	869	1	1.5	78	30	59	4
LTR3084	644	932	1	1.5	84	30	62	4
LTR3096	748	1058	1	1.5	96	30	66	4
LTR3642	464	616	1	1.5	42	36	42	2
LTR3648	524	693	1	1.5	48	36	46	2
LTR3654	587	771	1	1.5	54	36	51	2
LTR3660	646	851	1	1.5	60	36	57	3
LTR3666	707	928	1	1.5	66	36	63	3
LTR3672	767	1005	1	1.5	72	36	68	3
LTR3678	829	1084	1	1.5	78	36	72	3
LTR3684	891	1164	1	1.5	84	36	74	4
LTR3696	1011	1319	1	1.5	96	36	79	4
LTR4248	628	794	1	1.5	48	42	57	3
LTR4254	702	884	1	1.5	54	42	59	3
LTR4260	777	973	1	1.5	60	42	62	3
LTR4266	851	1064	1	1.5	66	42	68	3
LTR4272	921	1154	1	1.5	72	42	73	3
LTR4278	995	1245	1	1.5	78	42	76	3
LTR4284	1069	1334	1	1.5	84	42	78	3
LTR4296	1215	1512	1	1.5	96	42	92	4
LTR4854	795	995	1	1.5	54	48	62	3
LTR4860	878	1097	1	1.5	60	48	66	3
LTR4866	961	1197	1	1.5	66	48	73	3
LTR4872	1043	1299	1	1.5	72	48	79	3
LTR4878	1127	1399	1	1.5	78	48	84	3
LTR4884	1210	1502	1	1.5	84	48	88	4
LTR4896	1376	1704	1	1.5	96	48	110	4

**LTR • Rectangle Table Top 2-Piece**

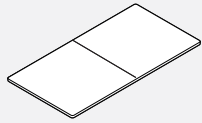

- Tables larger than 192" long are manufactured in 3 pieces.
- Tops with B and W thickness have 1" radius corners.

PRODUCT CODE	EDGE		SIZE/INCHES				WEIGHT LBS	VOL FT <sup>3</sup>
	B	W	H(B)	H(W)	W	D		
LTR36108	1500	1765	1	1.5	108	36	105	4
LTR36120	1650	1945	1	1.5	120	36	114	4
LTR42108	1710	2011	1	1.5	108	42	108	6
LTR42120	1880	2208	1	1.5	120	42	123	6
LTR48108	1909	2238	1	1.5	108	48	110	6
LTR48120	2107	2473	1	1.5	120	48	132	7
LTR48132	2299	2697	1	1.5	132	48	143	7
LTR48144	2332	2737	1	1.5	144	48	158	8
LTR48156	2681	3145	1	1.5	156	48	167	8
LTR48168	2871	3366	1	1.5	168	48	176	9
LTR48180	3218	3773	1	1.5	180	48	189	10
LTR48192	3253	3812	1	1.5	192	48	201	10
LTR54144	2829	3298	1	1.5	144	54	169	10
LTR54168	3253	3794	1	1.5	168	54	187	10
LTR54192	3680	4292	1	1.5	192	54	212	13
LTR54216	4106	4789	1	1.5	216	54	234	18
LTR54240	4533	5287	1	1.5	240	54	259	20
LTR60144	3100	3610	1	1.5	144	60	180	11
LTR60168	3571	4157	1	1.5	168	60	198	13
LTR60192	4041	4703	1	1.5	192	60	223	18
LTR60216	4512	5251	1	1.5	216	60	245	22
LTR60240	4981	5800	1	1.5	240	60	270	24

**LTRB • Rectangle Table Top With Bow Ends**

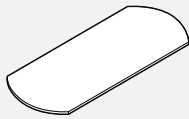

PRODUCT CODE	EDGE		SIZE/INCHES				WEIGHT LBS	VOL FT <sup>3</sup>
	B	W	H(B)	H(W)	W	D		
LTRB4284	1270	1583	1	1.5	84	42	78	3
LTRB4296	1445	1798	1	1.5	96	42	92	4
LTRB4884	1436	1783	1	1.5	84	48	88	4
LTRB4896	1634	2025	1	1.5	96	48	110	4

**LTRB • Rectangle Table Top With Bow Ends 2-Piece**

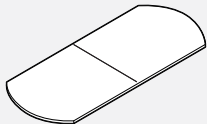

- Tables larger than 192" long are manufactured in 3 pieces.

PRODUCT CODE	EDGE		SIZE/INCHES				WEIGHT LBS	VOL FT <sup>3</sup>
	B	W	H(B)	H(W)	W	D		
LTRB42108	1763	2071	1	1.5	108	42	108	6
LTRB42120	1936	2276	1	1.5	120	42	123	6
LTRB48108	1968	2303	1	1.5	108	48	110	6
LTRB48120	2171	2548	1	1.5	120	48	132	7
LTRB48132	2366	2776	1	1.5	132	48	143	7
LTRB48144	2402	2821	1	1.5	144	48	158	8
LTRB48156	2762	3238	1	1.5	156	48	167	8
LTRB48168	2957	3467	1	1.5	168	48	176	9
LTRB48180	3315	3886	1	1.5	180	48	189	10
LTRB48192	3352	3930	1	1.5	192	48	201	10
LTRB54144	2914	3395	1	1.5	144	54	169	10
LTRB54168	3353	3908	1	1.5	168	54	187	10
LTRB54192	3790	4421	1	1.5	192	54	212	13
LTRB54216	4228	4932	1	1.5	216	54	234	18
LTRB54240	4669	5444	1	1.5	240	54	259	20
LTRB60144	3195	3718	1	1.5	144	60	180	11
LTRB60168	3679	4281	1	1.5	168	60	198	13
LTRB60192	4163	4846	1	1.5	192	60	223	18
LTRB60216	4646	5408	1	1.5	216	60	245	22
LTRB60240	5131	5973	1	1.5	240	60	270	24

**LRT • Racetrack Table Top**



PRODUCT CODE	EDGE		SIZE/INCHES				WEIGHT LBS	VOL FT <sup>3</sup>
	B	W	H(B)	H(W)	W	D		
LRT4284	1270	1583	1	1.5	84	42	78	3
LRT4296	1445	1798	1	1.5	96	42	92	4
LRT4884	1436	1783	1	1.5	84	48	88	4
LRT4896	1634	2025	1	1.5	96	48	110	4

**LRT • Racetrack Table Top 2-Piece**

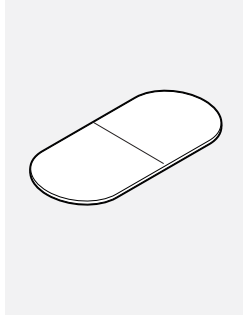

• Tables larger than 192" long are manufactured in 3 pieces.

PRODUCT CODE	EDGE		SIZE / INCHES				WEIGHT LBS	VOL FT <sup>3</sup>
	B	W	H(B)	H(W)	W	D		
LRT42108	1763	2071	1	1.5	108	42	108	6
LRT42120	1936	2276	1	1.5	120	42	123	6
LRT48108	1968	2303	1	1.5	108	48	110	6
LRT48120	2171	2548	1	1.5	120	48	132	7
LRT48132	2366	2776	1	1.5	132	48	143	7
LRT48144	2402	2821	1	1.5	144	48	158	8
LRT48156	2762	3238	1	1.5	156	48	167	8
LRT48168	2957	3467	1	1.5	168	48	176	9
LRT48180	3315	3886	1	1.5	180	48	189	10
LRT48192	3352	3930	1	1.5	192	48	201	10
LRT54144	2914	3395	1	1.5	144	54	169	10
LRT54168	3353	3908	1	1.5	168	54	187	10
LRT54192	3790	4421	1	1.5	192	54	204	10
LRT54216	4228	4932	1	1.5	216	54	226	11
LRT54240	4669	5444	1	1.5	240	54	253	11
LRT60144	3195	3718	1	1.5	144	60	180	11
LRT60168	3679	4281	1	1.5	168	60	198	13
LRT60192	4163	4846	1	1.5	192	60	223	18
LRT60216	4646	5408	1	1.5	216	60	245	22
LRT60240	5131	5973	1	1.5	240	60	270	24

**LO • Oval Table Top**

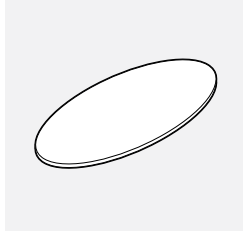

PRODUCT CODE	EDGE		SIZE / INCHES				WEIGHT LBS	VOL FT <sup>3</sup>
	B	W	H(B)	H(W)	W	D		
LO3672	912	1196	1	1.5	72	36	68	3
LO3684	1057	1383	1	1.5	84	36	74	3
LO3696	1203	1569	1	1.5	96	36	79	3
LO4284	1270	1583	1	1.5	84	42	78	3
LO4296	1445	1798	1	1.5	96	42	92	4
LO4884	1436	1783	1	1.5	84	48	88	4
LO4896	1634	2025	1	1.5	96	48	110	4

**LBT • Boat Table Top**

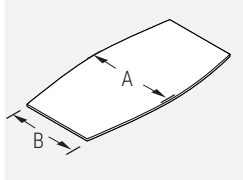

A	B
42	36
48	42

PRODUCT CODE	EDGE		SIZE / INCHES				WEIGHT LBS	VOL FT <sup>3</sup>
	B	W	H(B)	H(W)	W	D		
LBT4284	1270	1583	1	1.5	84	42	78	3
LBT4296	1445	1798	1	1.5	96	42	92	4
LBT4884	1436	1783	1	1.5	84	48	99	4
LBT4896	1634	2025	1	1.5	96	48	110	4

**LBT • Boat Table Top 2-Piece**

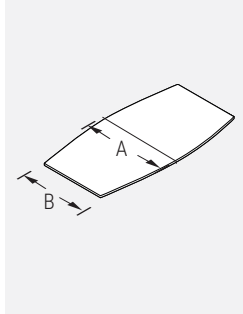

• Tables larger than 192" long are manufactured in 3 pieces.  
• 6" narrower at the ends.

A	B
42	36
48	42
54	48
60	54

PRODUCT CODE	EDGE		SIZE / INCHES				WEIGHT LBS	VOL FT <sup>3</sup>
	B	W	H(B)	H(W)	W	D		
LBT42108	1763	2071	1	1.5	108	42	108	6
LBT42120	1936	2276	1	1.5	120	42	123	6
LBT48108	1968	2303	1	1.5	108	48	110	6
LBT48120	2171	2548	1	1.5	120	48	132	7
LBT48132	2366	2776	1	1.5	132	48	143	7
LBT48144	2402	2821	1	1.5	144	48	158	8
LBT48156	2762	3238	1	1.5	156	48	167	8
LBT48168	2957	3467	1	1.5	168	48	176	9
LBT48180	3315	3886	1	1.5	180	48	189	10
LBT48192	3352	3930	1	1.5	192	48	201	10
LBT54144	2914	3395	1	1.5	144	54	169	10
LBT54168	3353	3908	1	1.5	168	54	187	10
LBT54192	3790	4421	1	1.5	192	54	212	13
LBT54216	4228	4932	1	1.5	216	54	234	18
LBT54240	4669	5444	1	1.5	240	54	259	20
LBT60144	3195	3718	1	1.5	144	60	180	11
LBT60168	3679	4281	1	1.5	168	60	198	13
LBT60192	4163	4846	1	1.5	192	60	223	18
LBT60216	4646	5408	1	1.5	216	60	245	22
LBT60240	5131	5973	1	1.5	240	60	270	24

**LBTB • Boat Table Top With Bow Ends**

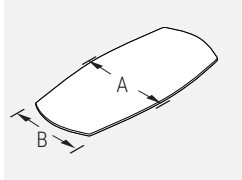

A	B
42	30
48	36

PRODUCT CODE	EDGE		SIZE/INCHES				WEIGHT LBS	VOL FT <sup>3</sup>
	B	W	H(B)	H(W)	W	D		
LBTB4284	1270	1583	1	1.5	84	42	78	3
LBTB4296	1445	1798	1	1.5	96	42	92	4
LBTB4884	1436	1783	1	1.5	84	48	88	4
LBTB4896	1634	2025	1	1.5	96	48	110	4

**LBTB • Boat Table Top With Bow Ends 2-Piece**

• Tables larger than 192" long are manufactured in 3 pieces.

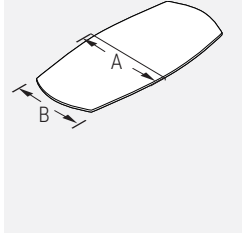

A	B
60	48
54	42
48	36
42	30

PRODUCT CODE	EDGE		SIZE/INCHES				WEIGHT LBS	VOL FT <sup>3</sup>
	B	W	H(B)	H(W)	W	D		
LBTB42108	1763	2071	1	1.5	108	42	108	6
LBTB42120	1936	2276	1	1.5	120	42	123	6
LBTB48108	1968	2303	1	1.5	108	48	110	6
LBTB48120	2171	2548	1	1.5	120	48	132	7
LBTB48132	2366	2776	1	1.5	132	48	143	7
LBTB48144	2402	2821	1	1.5	144	48	158	8
LBTB48156	2762	3238	1	1.5	156	48	167	8
LBTB48168	2957	3467	1	1.5	168	48	176	9
LBTB48180	3315	3886	1	1.5	180	48	189	10
LBTB48192	3352	3930	1	1.5	192	48	204	11
LBTB54144	2914	3395	1	1.5	144	54	176	9
LBTB54168	3353	3908	1	1.5	168	54	187	10
LBTB54192	3790	4421	1	1.5	192	54	212	13
LBTB54216	4228	4932	1	1.5	216	54	234	18
LBTB54240	4669	5444	1	1.5	240	54	259	20
LBTB60144	3195	3718	1	1.5	144	60	180	11
LBTB60168	3679	4281	1	1.5	168	60	198	13
LBTB60192	4163	4846	1	1.5	192	60	223	18
LBTB60216	4646	5408	1	1.5	216	60	245	22
LBTB60240	5131	5973	1	1.5	240	60	270	24

**LTW • Wedge Table Top**

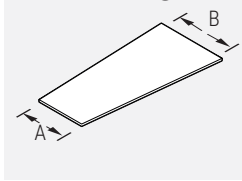

A	B
36	48

PRODUCT CODE	EDGE		SIZE/INCHES				WEIGHT LBS	VOL FT <sup>3</sup>
	B	W	H(B)	H(W)	W	D		
LTW4896	1634	2025	1	1.5	96	48	110	4

**LTW • Wedge Table Top 2-Piece**

• Tables larger than 192" long are manufactured in 3 pieces.

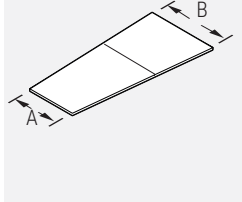

A	B
48	60
42	54
36	48

PRODUCT CODE	EDGE		SIZE/INCHES				WEIGHT LBS	VOL FT <sup>3</sup>
	B	W	H(B)	H(W)	W	D		
LTW48108	1968	2303	1	1.5	108	48	110	6
LTW48120	2171	2548	1	1.5	120	48	132	7
LTW48132	2366	2776	1	1.5	132	48	143	7
LTW48144	2402	2821	1	1.5	144	48	158	8
LTW48156	2762	3238	1	1.5	156	48	167	8
LTW48168	2957	3467	1	1.5	168	48	176	9
LTW48180	3315	3886	1	1.5	180	48	189	10
LTW48192	3352	3930	1	1.5	192	48	201	10
LTW54144	2914	3395	1	1.5	144	54	169	10
LTW54168	3353	3908	1	1.5	168	54	187	10
LTW54192	3790	4421	1	1.5	192	54	212	13
LTW54216	4228	4932	1	1.5	216	54	234	18
LTW54240	4669	5444	1	1.5	240	54	259	20
LTW60144	3195	3718	1	1.5	144	60	180	11
LTW60168	3679	4281	1	1.5	168	60	198	13
LTW60192	4163	4846	1	1.5	192	60	223	18
LTW60216	4646	5408	1	1.5	216	60	245	22
LTW60240	5131	5973	1	1.5	240	60	270	24

LTW \_ \_ - first dash is A and second dash is the length, B is not included in code.

**LTWB • Wedge Table Top With Bow Ends**

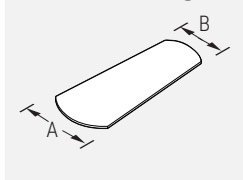

A	B
48	36

PRODUCT CODE	EDGE		H(B)	H(W)	W	D	WEIGHT LBS	VOL FT <sup>3</sup>
	B	W						
LTWB4896	1634	2025	1	1.5	96	48	110	4

**LTWB • Wedge Table Top With Bow Ends 2-Piece**

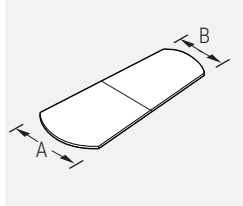

• Tables larger than 192" long are manufactured in 3 pieces.

A	B
48	36
54	42
60	48

PRODUCT CODE	EDGE		H(B)	H(W)	W	D	WEIGHT LBS	VOL FT <sup>3</sup>
	B	W						
LTWB48108	1968	2303	1	1.5	108	48	110	6
LTWB48120	2171	2548	1	1.5	120	48	132	7
LTWB48132	2366	2776	1	1.5	132	48	143	7
LTWB48144	2402	2821	1	1.5	144	48	158	8
LTWB48156	2762	3238	1	1.5	156	48	167	8
LTWB48168	2957	3467	1	1.5	168	48	176	9
LTWB48180	3315	3886	1	1.5	180	48	189	10
LTWB48192	3352	3930	1	1.5	192	48	198	11
LTWB54144	2914	3395	1	1.5	144	54	178	9
LTWB54168	3353	3908	1	1.5	168	54	187	10
LTWB54192	3790	4421	1	1.5	192	54	212	13
LTWB54216	4228	4932	1	1.5	216	54	234	18
LTWB54240	4669	5444	1	1.5	240	54	259	20
LTWB60144	3195	3718	1	1.5	144	60	180	11
LTWB60168	3679	4281	1	1.5	168	60	198	13
LTWB60192	4163	4846	1	1.5	192	60	223	18
LTWB60216	4646	5408	1	1.5	216	60	245	22
LTWB60240	5131	5973	1	1.5	240	60	270	24

**LHM • Halfmoon Table Top**

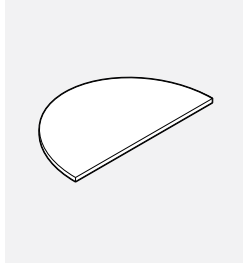

PRODUCT CODE	EDGE		H(B)	H(W)	W	D	WEIGHT LBS	VOL FT <sup>3</sup>
	B	W						
LHM2424	227	331	1	1.5	24	24	29	3
LHM2448	433	547	1	1.5	48	24	35	3
LHM2460	571	671	1	1.5	60	24	42	4
LHM2472	622	795	1	1.5	72	24	53	6
LHM3030	288	479	1	1.5	30	30	32	3
LHM3048	506	659	1	1.5	48	30	40	4
LHM3060	593	808	1	1.5	60	30	48	6
LHM3072	655	960	1	1.5	72	30	57	7

**LTZ • Trapezoid Table Top**

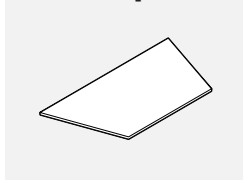

PRODUCT CODE	EDGE		H(B)	H(W)	W	D	WEIGHT LBS	VOL FT <sup>3</sup>
	B	W						
LTZ2460	571	671	1	1.5	60	24	42	4
LTZ2472	622	795	1	1.5	72	24	53	6
LTZ3060	593	808	1	1.5	60	30	48	6
LTZ3072	655	960	1	1.5	72	30	57	7

**LW • Wave Table Top**

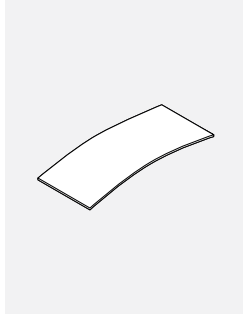

PRODUCT CODE	EDGE		H(B)	H(W)	W	D	WEIGHT LBS	VOL FT <sup>3</sup>
	B	W						
LW2448	433	547	1	1.5	48	24	35	3
LW2460	571	671	1	1.5	60	24	42	4
LW2466	593	734	1	1.5	66	24	47	6
LW2472	622	795	1	1.5	72	24	53	6
LW3060	593	808	1	1.5	60	30	48	6
LW3066	621	883	1	1.5	66	30	53	7
LW3072	655	960	1	1.5	72	30	64	8
LW3660	766	1010	1	1.5	60	36	53	7
LW3666	840	1102	1	1.5	66	36	63	8
LW3672	912	1196	1	1.5	72	36	68	9

**LCT • Cross Base for Table Tops**

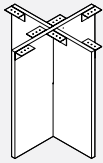

PRODUCT CODE	PRICE	SIZE/INCHES			WEIGHT		VOL FT <sup>3</sup>
		H	W	D	LBS		
LCT18	600	28	18	18	29	6	
LCT24	600	28	24	24	39	4	
LCT30	676	28	30	30	48	6	
LCT36	676	28	36	36	57	8	
LCT42	870	28	42	42	62	9	

**LR • Rectangular Base for Table Tops**

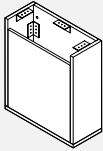

• Short side panel is removable for full wire access.

PRODUCT CODE	PRICE	SIZE/INCHES			WEIGHT		VOL FT <sup>3</sup>
		H	W	D	LBS		
LR18	520	28	18	10	39	3	
LR24	589	28	24	10	46	4	
LR30	649	28	30	10	54	6	
LR36	728	28	36	10	66	8	
LR42	836	28	42	10	83	9	

**LSQ • Square Base for Table Tops**

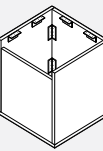

• Short side panel is removable for full wire access.

PRODUCT CODE	PRICE	SIZE/INCHES			WEIGHT		VOL FT <sup>3</sup>
		H	W	D	LBS		
LSQ18	655	28	18	18	50	7	
LSQ24	802	28	24	24	66	11	
LSQ30	957	28	30	30	83	17	

**LDRUM • Drum Base for Table Tops**

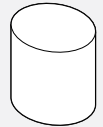

PRODUCT CODE	PRICE	SIZE/INCHES			WEIGHT		VOL FT <sup>3</sup>
		H	W	D	LBS		
LDRUM18	1059	28	18	18	32	8	
LDRUM24	1130	28	24	24	43	11	
LDRUM30	1161	28	30	30	54	14	

**LV • "V" Base for Table Tops**

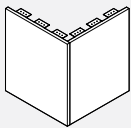

PRODUCT CODE	PRICE	SIZE/INCHES			WEIGHT		VOL FT <sup>3</sup>
		H	W	D	LBS		
LV1818	349	28	18	18	29	3	
LV2424	396	28	24	24	39	4	
LV3030	469	28	30	30	48	6	

**LELBA • Elliptical Base With Aluminum Extrusion**

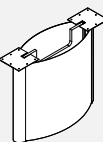

- Laminate side panels are removable for full wire access.
- Standard in metal paint finishes.
- Optional anodized aluminum finish available, please add \$45 list.

PRODUCT CODE	PRICE	SIZE/INCHES			WEIGHT		VOL FT <sup>3</sup>
		H	W	D	LBS		
LELBA18	1396	28	18	9	33	2	
LELBA24	1450	28	24	10	44	2	
LELBA30	1507	28	30	12	55	4	
LELBA36	1570	28	36	13	66	7	
LELBA42	1630	28	42	14	77	9	

**TELRR • Rectangular Panel Base With Anodized Aluminum Radius Corner Detail**

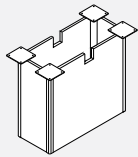

• Single hinged access door is optional. Add "HD" to the end of the code. Add \$108 to list price.

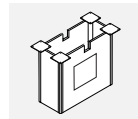

PRODUCT CODE	PRICE	SIZE/INCHES			WEIGHT LBS	VOL FT <sup>3</sup>
		H	W	D		
TELRR18	883	28	18	12	66	7
TELRR24	932	28	24	12	72	9
TELRR30	984	28	30	12	105	11
TELRR36	1036	28	36	12	129	13
TELRR42	1086	28	42	12	129	15

**TELBR • Rectangular Base With Rectangular Anodized Aluminum Corner Detail**

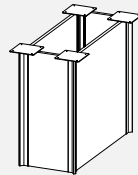

• Single hinged access door is optional. Add "HD" to the end of the code. Add \$108 to list price.

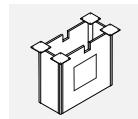

PRODUCT CODE	PRICE	SIZE/INCHES			WEIGHT LBS	VOL FT <sup>3</sup>
		H	W	D		
TELBR18	912	28	18	12	66	7
TELBR24	964	28	24	12	72	9
TELBR30	1014	28	30	12	105	11
TELBR36	1065	28	36	12	129	13
TELBR42	1118	28	42	12	129	15

**TELSR • Square Panel Base With Anodized Aluminum Radius Corner Detail**

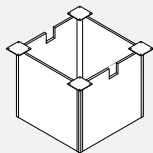

• Single hinged access door is optional. Add "HD" to the end of the code. Add \$108 to list price.

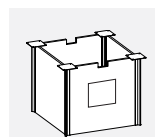

PRODUCT CODE	PRICE	SIZE/INCHES			WEIGHT LBS	VOL FT <sup>3</sup>
		H	W	D		
TELSR18	949	28	18	18	77	7
TELSR24	1045	28	24	24	83	9
TELSR30	1142	28	30	30	117	20
TELSR36	1241	28	36	36	140	24
TELSR42	1339	28	42	42	140	24

**TELBS • Square Base With Rectangular Anodized Aluminum End Detail**

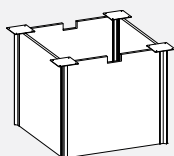

• Single hinged access door is optional. Add "HD" to the end of the code. Add \$108 to list price.

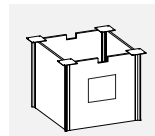

PRODUCT CODE	PRICE	SIZE/INCHES			WEIGHT LBS	VOL FT <sup>3</sup>
		H	W	D		
TELBS18	977	28	18	18	77	7
TELBS24	1092	28	24	24	83	9
TELBS30	1215	28	30	30	117	20
TELBS36	1346	28	36	36	140	24
TELBS42	1486	28	42	42	140	24

**TRUM • Trumpet Column Base**

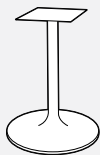

PRODUCT CODE	PRICE		SIZE/INCHES			WEIGHT LBS	VOL FT <sup>3</sup>
	PAINTED	CHROME	H	W	D		
TRUM18	581	705	28	18	18	15	9
TRUM24	663	788	28	24	24	18	13
TRUM30	1078	1203	28	30	30	20	15
TRUM18BH	854	945	40.5	18	18	26	18
TRUM24BH	978	1069	40.5	24	24	29	15

**TTFD • Flat Disk Column Base**

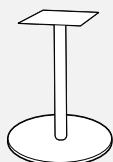

PRODUCT CODE	PRICE		SIZE/INCHES			WEIGHT LBS	VOL FT <sup>3</sup>
	PAINTED	CHROME	H	W	D		
TTFD18	1036	1119	28	18	18	50	9
TTFD22	1119	1203	28	22	22	55	13
TTFD24	1203	1286	28	24	24	66	14
TTFD30	1615	1699	28	30	30	88	15
TTFD36	2320	2487	28	36	36	110	15
TTFD18BH	1268	1350	40.5	18	18	72	11
TTFD22BH	1350	1434	40.5	22	22	77	15
TTFD24BH	1434	1516	40.5	24	24	110	17

**TTSQ • Flat Square Column Base**

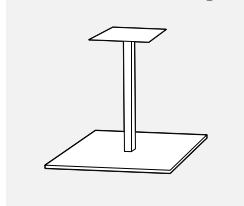

- Plate size: (18" - 30" 11" x 11"), (36" 14" x 14").
- Column size: (18" - 24" 2.1/2"), (30" - 36" 3")

PRODUCT CODE	PRICE		SIZE/INCHES			WEIGHT LBS	VOL FT <sup>3</sup>
	PAINTED	CHROME	H	W	D		
TTSQ18	1450	1533	28	18	18	50	9
TTSQ23	1615	1699	28	23	23	61	13
TTSQ30	2073	2155	28	30	30	88	15
TTSQ18BH	1684	1766	40.5	18	18	72	11
TTSQ23BH	1850	1931	40.5	23	23	83	15

**TTFLTX • Flat Bar "X" Column Base**



- Plate size: (18" - 30" 11" x 11"), (36" 14" x 14").
- Column size: (18" - 24" 2.1/2"), (30" - 36" 3")

PRODUCT CODE	PRICE		SIZE/INCHES			WEIGHT LBS	VOL FT <sup>3</sup>
	PAINTED	CHROME	H	W	D		
TTFLTX18	1533	1740	28	18	18	15	9
TTFLTX22	1554	1763	28	22	22	17	11
TTFLTX24	1575	1781	28	24	24	18	13
TTFLTX30	1615	1823	28	30	30	20	15
TTFLTX36	1657	1864	28	36	36	22	24
TTFLTX18BH	1766	1972	40.5	18	18	26	11
TTFLTX22BH	1785	1993	40.5	22	22	28	13
TTFLTX24BH	1850	2014	40.5	24	24	29	15

**TTFLT • Flat Bar "T" Column Base**



- Plate size: (18" - 30" 11" x 11"), (36" 14" x 14").
- Column size: (18" - 24" 2.1/2"), (30" - 36" 3")

PRODUCT CODE	PRICE		SIZE/INCHES			WEIGHT LBS	VOL FT <sup>3</sup>
	PAINTED	CHROME	H	W	D		
TTFLT18	1161	1328	28		18	9	2
TTFLT22	1181	1346	28		22	10	2
TTFLT24	1203	1369	28		24	11	3
TTFLT30	1245	1408	28		30	13	3
TTFLT36	1286	1450	28		36	15	3

**TTFL3P • Flat Bar 3-Prong Column Base**



- Plate size: (18" - 30" 11" x 11"), (36" 14" x 14").
- Column size: (18" - 24" 2.1/2"), (30" - 36" 3")

PRODUCT CODE	PRICE		SIZE/INCHES			WEIGHT LBS	VOL FT <sup>3</sup>
	PAINTED	CHROME	H	W	D		
TTFL3P18	1450	1657	28		18	11	7
TTFL3P22	1472	1679	28		22	12	13
TTFL3P24	1491	1699	28		24	13	15
TTFL3P30	1533	1740	28		30	15	15
TTFL3P36	1554	1781	28		36	18	24

**LL4S • 4-Star Table Leg With Bullnose End**



- Leg Plate is 11" x 11" for 26" and 30" spread and 14" x 14" for 36" spread.
- For the caster option specify "CS" at the end of the code with a \$68 upcharge

PRODUCT CODE	PRICE		SIZE/INCHES			WEIGHT LBS	VOL FT <sup>3</sup>
	PAINTED	CHROME	H	W	D		
LL4S18	589	696	28	18	18	15	7
LL4S26	697	804	28	26	26	18	15
LL4S30	745	852	28	30	30	20	15
LL4S36	816	923	28	36	36	22	24

**LL4S-42 • Bistro Leg With Bullnose End**

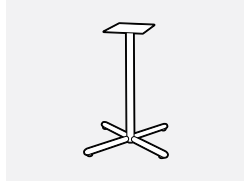

- Leg Plate is 11" x 11" for 26" and 30" spread.

PRODUCT CODE	PRICE		SIZE/INCHES			WEIGHT LBS	VOL FT <sup>3</sup>
	PAINTED	CHROME	H	W	D		
LL4S2642	799	907	40.5	26	26	22	18
LL4S3042	851	957	40.5	30	30	24	23
LL4S3642	1029	1135	40.5	36	36	26	28

**LLT • "T" Table Leg With Bullnose End**



- Leg Plate is 11" x 11"
- For the caster option specify "CS" at the end of the code with a \$34 upcharge

PRODUCT CODE	PRICE		SIZE/INCHES			WEIGHT LBS	VOL FT <sup>3</sup>
	PAINTED	CHROME	H	W	D		
LLT18	258	365	28	18	6	9	2
LLT26	275	382	28	26	6	11	3
LLT30	284	389	28	30	6	13	3
LLT36	501	606	28	36	6	15	3



**LLTT • "TT" Table Leg With Bullnose End**



- Leg Plate is 11"x 24"
- For the caster option specify "CS" at the end of the code with a \$34 upcharge

PRODUCT CODE	PRICE		SIZE / INCHES			WEIGHT		VOL FT <sup>3</sup>
	PAINTED	CHROME	H	W	D	LBS		
LLTT18	431	565	28	18	6	13	2	
LLTT26	452	587	28	26	6	20	3	
LLTT30	479	612	28	30	6	24	3	
LLTT36	685	817	28	36	6	26	3	
LLTT42	858	993	28	42	6	31	4	

**LLSQ • Square Post Leg**

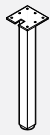

- 2.5" x 2.5" square tubular leg provides support for worksurfaces.
- Top plate welded to leg.
- 8" x 8" plate attached with #10 3/4" wood screws included.
- 1" height adjustment range.

PRODUCT CODE	PRICE		SIZE / INCHES			WEIGHT		VOL FT <sup>3</sup>
	PAINTED	CHROME	H	W	D	LBS		
LLSQ25X25H28	200	302	28	2.5	2.5	9	0.17	

**LATBL • Tapered Leg**



- Tapered leg provides support for worksurfaces.
- Top plate welded to leg.
- 8" x 8" plate attached with #10 3/4" wood screws included.
- 1" height adjustment range.
- Bottom of leg tube is a 1" diameter and top is 2 3/8" diameter.

PRODUCT CODE	PRICE		SIZE / INCHES			WEIGHT		VOL FT <sup>3</sup>
	PAINTED	CHROME	H	W	D	LBS		
LATBL28	227	334	28	3	3	9	0.17	

**BHML • Monoleg**



- 3" diameter Monoleg provides support for worksurfaces.
- Top plate welded to leg.
- 8" x 8" plate attached with #10 3/4" wood screws included.
- 1" height adjustment range.

PRODUCT CODE	PRICE		SIZE / INCHES			WEIGHT		VOL FT <sup>3</sup>
	PAINTED	CHROME	H	W	D	LBS		
BHML03	190	297	28	3	3	9	0.17	

**L2BHML • Monoleg**

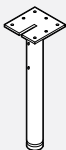

- 3" diameter Monoleg provides support for worksurfaces.
- Cut-out top plate welded to leg. Cut-out accepts 3/4" modesty panel.
- 8" x 8" plate attached with #10 3/4" wood screws included.
- 1" height adjustment range.

PRODUCT CODE	PRICE		SIZE / INCHES			WEIGHT		VOL FT <sup>3</sup>
	PAINTED	CHROME	H	W	D	LBS		
L2BHML03	173	280	28	3	3	9	0.17	

**LBHML06 • 6" Monoleg**

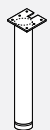

- 6" diameter Monoleg provides support for worksurfaces.
- Top plate welded to leg flush.
- 8" x 8" plate attached with #10 3/4" wood screws, included.
- 1" height adjustment range.
- Leg is offset flush to edge.

PRODUCT CODE	PRICE		SIZE / INCHES			WEIGHT		VOL FT <sup>3</sup>
	PAINTED	CHROME	H	W	D	LBS		
LBHML06	287	421	28	6	6	9	0.17	

**FOLDLEG • Folding Leg**



- Sold as a set of two.
- Available in only in (SIL) Silver or (BLK) Black.

PRODUCT CODE	PRICE	SIZE / INCHES			WEIGHT LBS	VOL FT <sup>3</sup>
		H	W	D		
FOLDLEG	541	28	24.625	3	11	7

**LHC • HAT Channel for Conference Tables**

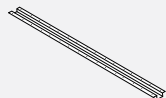

- See chart on page H.2

PRODUCT CODE	PRICE	SIZE / INCHES			WEIGHT LBS	VOL FT <sup>3</sup>
		H	W	D		
LHC40	75	1.4	40	5	4	0.20
LHC46	83	1.4	46	5	6	0.22
LHC52	91	1.4	52	5	7	0.25
LHC58	102	1.4	58	5	8	0.28
LHC64	113	1.4	64	5	9	0.31
LHC70	124	1.4	70	5	10	0.33

**BRTSLxxC • Single Leg Assembly (Casters)**

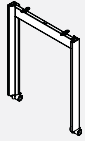

- Two Single Leg Assemblies form the structure of a table.
- 40mm white locking casters with grey tires; steel frame, aluminum legs.
- Anodized aluminum leg upcharge \$67.
- Please specify paint finish for support.

PRODUCT CODE	PRICE	SIZE/INCHES			WEIGHT VOL	
		H	W	D	LBS	FT <sup>3</sup>
L2BRTSL24C	592	28	2.5	24	8	1.34
L2BRTSL30C	615	28	2.5	30	8	1.41
L2BRTSL36C	641	28	2.5	36	8	1.81

**BRTSLxxL • Single Leg Assembly (Levelers)**

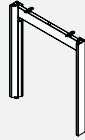

- Two Single Leg Assemblies form the structure of a table.
- One leg can be shared by 2 adjoining worksurfaces.
- Leveling glides, steel frame, aluminum legs.
- Anodized aluminum leg upcharge \$67.
- Please specify paint finish for support.
- Please specify 2 beams when using BRTSL36L.

PRODUCT CODE	PRICE	SIZE/INCHES			WEIGHT VOL	
		H	W	D	LBS	FT <sup>3</sup>
L2BRTSL24L	590	28	2.5	24	8	1.34
L2BRTSL30L	616	28	2.5	30	8	1.34
L2BRTSL36L	653	28	2.5	36	9	1.50

**BRTBAxxL • Back-2-Back Leg Assembly (Levelers)**

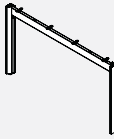

- Two Back-2-Back Leg Assemblies form the structure of Back-2-Back Tables.
- One double leg can be shared by 4 adjoining worksurfaces.
- Leveling, steel frame, aluminum legs.
- Anodized aluminum leg upcharge \$67.
- Please specify paint finish for support.

PRODUCT CODE	PRICE	SIZE/INCHES			WEIGHT VOL	
		H	W	D	LBS	FT <sup>3</sup>
L2BRTBA34L	538	28	2.5	34	10	2.47
L2BRTBA51L	582	28	2.5	50.5	12	2.96
L2BRTBA63L	606	28	2.5	62.5	13	3.21

**BRTHLxxxxC • Single "H" Leg Assembly (Casters)**

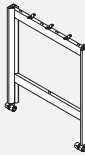

- Two Single Leg Assemblies form the structure of a table.
- Leveling glides, steel frame, aluminum legs.
- Anodized aluminum leg upcharge \$67.
- Please specify paint finish for support.
- Note:
- 24" deep tables must have three (3) beams at the top, and one beam (BRTBBxxC "Bottom Table Beam") at the bottom.
- 30" and 36" deep tables must have four (4) beams at the top, and one beam (BRTBBxxC "Bottom Table Beam") at the bottom.

PRODUCT CODE	PRICE	SIZE/INCHES			WEIGHT VOL	
		H	W	D	LBS	FT <sup>3</sup>
L2BRTHL3624C	673	35	2.5	24	14	1.68
L2BRTHL3630C	713	35	2.5	30	16	1.76
L2BRTHL3636C	806	35	2.5	36	18	2.26
L2BRTHL4224C	703	41	2.5	24	15	1.96
L2BRTHL4230C	744	41	2.5	30	17	2.06
L2BRTHL4236C	838	41	2.5	36	19	2.65

**BRTHLxxxxL • Single "H" Leg Assembly (Levelers)**

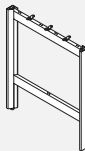

- Two Single Leg Assemblies form the structure of a table.
- One leg can be shared by 2 adjoining worksurfaces.
- Leveling glides, steel frame, aluminum legs.
- Anodized aluminum leg upcharge \$67.
- Please specify paint finish for support.
- Note:
- 24" deep tables must have three (3) beams at the top, and one beam (BRTBBxxC "Bottom Table Beam") at the bottom.
- 30" and 36" deep tables must have four (4) beams at the top, and one beam (BRTBBxxC "Bottom Table Beam") at the bottom.

PRODUCT CODE	PRICE	SIZE/INCHES			WEIGHT VOL	
		H	W	D	LBS	FT <sup>3</sup>
L2BRTHL3624L	619	35	2.5	24	14	1.68
L2BRTHL3630L	659	35	2.5	30	16	1.76
L2BRTHL3636L	751	35	2.5	36	18	2.26
L2BRTHL4224L	651	41	2.5	24	15	1.96
L2BRTHL4230L	691	41	2.5	30	17	2.06
L2BRTHL4236L	783	41	2.5	36	19	2.65

**BRTSLLxx • Single Loop Leg**

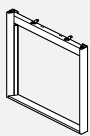

- Two Single Leg Assemblies form the structure of a table.
- One leg can be shared by 2 adjoining worksurfaces.
- Leveling glides, steel frame, aluminum legs.
- Anodized aluminum leg upcharge \$67.
- Please specify paint finish for support.
- Please specify two beams when using BRTSLL36L.

PRODUCT CODE	PRICE	SIZE/INCHES			WEIGHT VOL	
		H	W	D	LBS	FT <sup>3</sup>
L2BRTSLL24L	512	28	2.5	24	11.00	1.01
L2BRTSLL30L	545	28	2.5	30	13.75	1.26
L2BRTSLL36L	589	28	2.5	36	16.50	1.51

**BRTBALLxx • Back-2-Back Loop Leg**

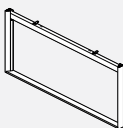

- Two Back-2-Back Leg Assemblies form the structure of Back-2-Back Tables.
- One double leg can be shared by 4 adjoining worksurfaces.
- Leveling glides, steel frame, aluminum legs.
- Anodized aluminum leg upcharge \$67.
- Please specify paint finish for support.

PRODUCT CODE	PRICE	SIZE/INCHES			WEIGHT VOL	
		H	W	D	LBS	FT <sup>3</sup>
L2BRTBALL51L	711	28	2.5	50.5	23.14	2.12
L2BRTBALL63L	743	28	2.5	62.5	28.64	2.62

**LVB • Visual Board**

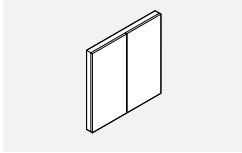

• See page H.1 for technical information.

PRODUCT CODE	FINISH		SIZE/INCHES			WEIGHT		VOL FT <sup>3</sup>
	LP/B	HP/B	H (LP/B)	W	D	LBS		
LVB48	1969	2180	48	48	8	154	10	
LVB48MG	2009	2337	48	48	8	154	10	

**L2CT • Collaboration Tables With Integrated Wire Management**

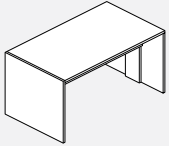

- Units Shipped knocked down (KD)
- Footrest to be ordered separately.
- Add "FR" to the end of the code for a footrail and add \$2,446 to the list price.
- Foot rail kit will include a quantity of two 2" diameter rails and 4 flanges.
- "W" thick (1 7/16") top and gables.
- Low pressure modesty panel.

**Standard Grommet Location:**

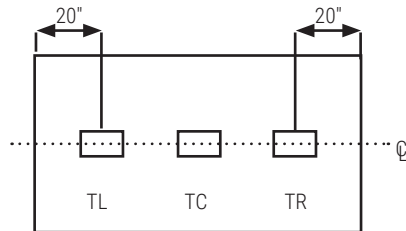

Please see Accessories Section for power grommets.

Half Modesty at 15" high.

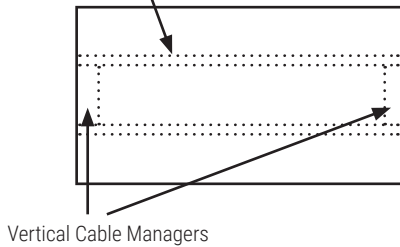

PRODUCT CODE	FINISH "W"	SIZE / INCHES		WEIGHT LBS	VOL FT <sup>3</sup>
		W	D		
L2CT3060H29	2310	60	30	171	13
L2CT3066H29	2411	66	30	180	14
L2CT3072H29	2511	72	30	189	15
L2CT3078H29	2610	78	30	198	16
L2CT3084H29	2709	84	30	207	18
L2CT3096H29	2907	96	30	216	20
L2CT3060H36	2450	60	30	176	19
L2CT3066H36	2554	66	30	185	21
L2CT3072H36	2651	72	30	194	23
L2CT3078H36	2749	78	30	203	24
L2CT3084H36	2851	84	30	212	26
L2CT3096H36	3050	96	30	221	30
L2CT3060H42	2650	60	30	181	25
L2CT3066H42	2749	66	30	190	28
L2CT3072H42	2850	72	30	199	30
L2CT3078H42	2949	78	30	208	33
L2CT3084H42	3049	84	30	217	35
L2CT3096H42	3248	96	30	226	40
L2CT3660H29	2595	60	36	180	15
L2CT3666H29	2703	66	36	189	17
L2CT3672H29	2816	72	36	198	18
L2CT3678H29	2926	78	36	207	20
L2CT3684H29	3035	84	36	216	21
L2CT3696H29	3259	96	36	225	24
L2CT3660H36	2764	60	36	185	23
L2CT3666H36	2871	66	36	194	25
L2CT3672H36	2984	72	36	203	27
L2CT3678H36	3094	78	36	212	29
L2CT3684H36	3206	84	36	221	32
L2CT3696H36	3427	96	36	230	36
L2CT3660H42	2988	60	36	190	30
L2CT3666H42	3099	66	36	199	33
L2CT3672H42	3210	72	36	208	36
L2CT3678H42	3319	78	36	217	39
L2CT3684H42	3431	84	36	226	42
L2CT3696H42	3654	96	36	235	48
L2CT4260H29	2875	60	42	189	18
L2CT4266H29	2997	66	42	198	19
L2CT4272H29	3119	72	42	207	21
L2CT4278H29	3243	78	42	216	23
L2CT4284H29	3363	84	42	225	25
L2CT4296H29	3609	96	42	234	28
L2CT4260H36	3072	60	42	194	26
L2CT4266H36	3195	66	42	203	29
L2CT4272H36	3315	72	42	212	32
L2CT4278H36	3438	78	42	221	34
L2CT4284H36	3563	84	42	230	37
L2CT4296H36	3806	96	42	239	42
L2CT4260H42	3326	60	42	199	35
L2CT4266H42	3448	66	42	208	39
L2CT4272H42	3571	72	42	217	42
L2CT4278H42	3692	78	42	226	46
L2CT4284H42	3815	84	42	235	49
L2CT4296H42	4059	96	42	244	56

L2CTV • Collaboration Tables With Media-Wall-Integrated Wire Management

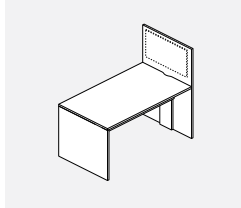

- Units Shipped knocked down (KD)
- Footrest to be ordered separately.
- Add "FR" to the end of the code for a foot rail and add \$2,446 to the list price.
- Foot rail kit will include a quantity of two 2" diameter rails and 4 flanges.
- Unit includes TV/Display bracket & mounting hardware.
- "W" thick (1 7/16") top and gables.
- Low pressure modesty panel.

Standard Grommet Location:

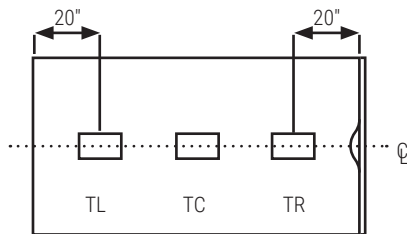

Please see Accessories Section for power grommets.

Half Modesty at 15" high.

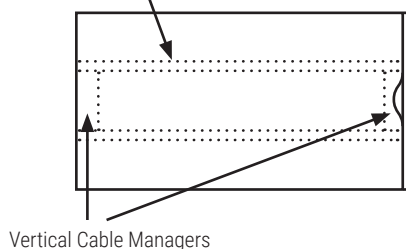

PRODUCT CODE	FINISH "W"	SIZE/INCHES		WEIGHT LBS	VOL FT <sup>3</sup>
		W	D		
L2CTV4260H29H66	4253	60	42	192	18
L2CTV4266H29H66	4376	66	42	201	19
L2CTV4272H29H66	4497	72	42	210	21
L2CTV4278H29H66	4620	78	42	219	23
L2CTV4284H29H66	4742	84	42	228	25
L2CTV4296H29H66	4987	96	42	237	28
L2CTV4860H29H66	4620	60	48	198	20
L2CTV4866H29H66	4751	66	48	207	22
L2CTV4872H29H66	4886	72	48	216	24
L2CTV4878H29H66	5018	78	48	225	26
L2CTV4884H29H66	5154	84	48	234	28
L2CTV4896H29H66	5418	96	48	243	32
L2CTV4260H36H72	4448	60	42	197	26
L2CTV4266H36H72	4573	66	42	206	29
L2CTV4272H36H72	4695	72	42	215	32
L2CTV4278H36H72	4816	78	42	224	34
L2CTV4284H36H72	4937	84	42	233	37
L2CTV4296H36H72	5181	96	42	242	42
L2CTV4860H36H72	4842	60	48	203	30
L2CTV4866H36H72	4976	66	48	212	33
L2CTV4872H36H72	5110	72	48	221	36
L2CTV4878H36H72	5244	78	48	230	39
L2CTV4884H36H72	5377	84	48	239	42
L2CTV4896H36H72	4969	96	48	248	48
L2CTV4260H42H72	4604	60	42	202	35
L2CTV4266H42H72	4726	66	42	211	39
L2CTV4272H42H72	4848	72	42	220	42
L2CTV4278H42H72	5016	78	42	229	46
L2CTV4284H42H72	5093	84	42	238	49
L2CTV4296H42H72	5382	96	42	247	56
L2CTV4860H42H72	5012	60	48	208	40
L2CTV4866H42H72	5144	66	48	217	44
L2CTV4872H42H72	5280	72	48	226	48
L2CTV4878H42H72	5412	78	48	235	52
L2CTV4884H42H72	5547	84	48	244	56
L2CTV4896H42H72	5813	96	48	253	64

**MSPDM • 1 Duplex, 1 Data**



- Includes one duplex and two data jacks (both RJ45, Cat6)..
- Black plastic

PRODUCT CODE	PRICE	SIZE/INCHES			WEIGHT LBS	VOL FT <sup>3</sup>
		H	W	D		
MSPDM	355	2.75	6.5	3.5	2	0.1

**BG5 • Rectangular Grommet**

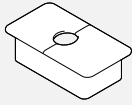

- Option (BLK) Black Plastic (GRY) Grey Plastic (WHT) White Plastic

PRODUCT CODE	PRICE	SIZE/INCHES			WEIGHT LBS	VOL FT <sup>3</sup>
		H	W	D		
BG5	58		3.5	2		

**GCRTMCS401 • Recessed Power Block, 1 Duplex, 1 Data Knock-out, 1 Power Duplex**

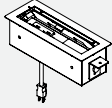

- Single sided recessed power block with 1 regular duplex and 1 data knock-out on top, 1 power duplex on bottom.
- 10 ft power cord with straight plug.
- Telecom plates ordered separately.
- Available in Black - B, Tungsten - T or Designer White - W as indicated by last letter of model number; duplexes always grey.
- Not approved for daisy-chain applications.

PRODUCT CODE	PRICE	SIZE/INCHES			WEIGHT LBS	VOL FT <sup>3</sup>
		H	W	D		
GCRTMCS401B	867	10.78	4.22	4.86	4.3	0.51
GCRTMCS401T	867	10.78	4.22	4.86	4.3	0.51
GCRTMCS401W	867	10.78	4.22	4.86	4.3	0.51

**GCRTMCS421 • Recessed Power Block, 1 Power including USB A+C, 1 Data Knock-out, 1 Power Duplex**

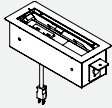

- Single sided recessed power block with 1 power and USB A+C duplex and 1 data knock-out on top, 1 power duplex on bottom.
- USB Type A port charges maximum 2.4 amps at 5V and Type C port charges maximum 3 amps at 5V.
- 10 ft power cord with straight plug.
- Telecom plates ordered separately.
- Available in Black - B, Tungsten - T or Designer White - W as indicated by last letter of model number; duplexes always grey.
- Not approved for daisy-chain applications.

PRODUCT CODE	PRICE	SIZE/INCHES			WEIGHT LBS	VOL FT <sup>3</sup>
		H	W	D		
GCRTMCS421B	1139	10.78	4.22	4.86	4.3	0.51
GCRTMCS421T	1139	10.78	4.22	4.86	4.3	0.51
GCRTMCS421W	1139	10.78	4.22	4.86	4.3	0.51

**GCRTMCS602 • Recessed Power Block, 2 Duplex, 2 Data Knock-outs, 1 Power Duplex**

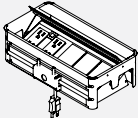

- Double-sided recessed power block with 2 regular duplex and 2 data knock-outs on top, 1 power duplex on bottom.
- 10 ft power cord with straight plug.
- Telecom plates ordered separately.
- Available in Black - B, Tungsten - T or Designer White - W as indicated by last letter of model number; duplexes always grey.
- Not approved for daisy-chain applications.

PRODUCT CODE	PRICE	SIZE/INCHES			WEIGHT LBS	VOL FT <sup>3</sup>
		H	W	D		
GCRTMCD602B	990	10.78	6.22	4.86	5.9	0.51
GCRTMCD602T	990	10.78	6.22	4.86	5.9	0.51
GCRTMCD602W	990	10.78	6.22	4.86	5.9	0.51

**GCRTMCS602 • Recessed Power Block, 2 Duplex, 2 Data Knock-outs, 1 Power Duplex**

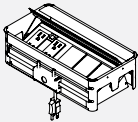

- Double-sided recessed power block with 1 regular duplex, 1 power and USB A+C and 2 data knock-outs on top, 1 power duplex on bottom.
- USB Type A port charges maximum 2.4 amps at 5V and Type C port charges maximum 3 amps at 5V.
- 10 ft power cord with straight plug.
- Telecom plates ordered separately.
- Available in Black - B, Tungsten - T or Designer White - W as indicated by last letter of model number; duplexes always grey.
- Not approved for daisy-chain applications.

PRODUCT CODE	PRICE	SIZE/INCHES			WEIGHT LBS	VOL FT <sup>3</sup>
		H	W	D		
GCRTMCD622B	1247	10.78	6.22	4.86	6.1	0.51
GCRTMCD622T	1247	10.78	6.22	4.86	6.1	0.51
GCRTMCD622W	1247	10.78	6.22	4.86	6.1	0.51

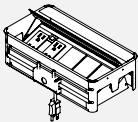

**GCRTMCS622 • Recessed Power Block, 2 Power Including USB A+C, 2 Data Knock-outs, 1 Power Duplex**



- Double-sided recessed power block with 2 power and USB A+C and 2 data knock-outs on top, 1 power duplex on bottom.
- USB Type A port charges maximum 2.4 amps at 5V and Type C port charges maximum 3 amps at 5V.
- 10 ft power cord with straight plug.
- Telecom plates ordered separately.
- Available in Black - B, Tungsten - T or Designer White - W as indicated by last letter of model number; duplexes always grey.
- Not approved for daisy-chain applications.

PRODUCT CODE	PRICE	SIZE/INCHES			WEIGHT LBS	VOL FT <sup>3</sup>
		H	W	D		
GCRTMCD642B	1502	10.78	6.22	4.86	6.3	0.51
GCRTMCD642T	1502	10.78	6.22	4.86	6.3	0.51
GCRTMCD642W	1502	10.78	6.22	4.86	6.3	0.51

**Telecom Plates**

	PRODUCT CODE	PRICE
	Black telecom plate with 2 RJ45 cat 6 data ABLBB	336
	Black telecom plate with 3 RJ45 cat 6 data ABLBBB	493
	Black telecom plate with 4 RJ45 cat 6 data ABLBBBB	652

**TERINA TABLES**

Terina™ is a multi-purpose table that allows you to quickly adapt your space to suit your needs. The simple flip-top mechanism is designed for single-handed operation. Tables nest in an upright position to minimize storage space.

**Worksurfaces**

Laminate surfaces (B) are 1-1/16" thick tops constructed of 45lb. density particle board with high pressure laminate and finished on the underside of the surface with a kraft paper backing. Veneer (V) surfaces are 1-3/16" thick tops constructed of 45 lb. density particle board and are balanced on the underside with veneer (unfinished). Worksurfaces are pre-drilled for alignment of the Terina base.

**Base**

Tables feature an aluminum leg, cross beam and die-cast foot. Legs and cross beam are available in all standard panel frame painted finishes. Die-cast foot is always in polished aluminum finish. Foot span is 36". Stacking depth of 9".

**Casters**

Casters are standard on all tables. 2-3/8" dual wheel casters with manual lock. Full 360° swivel. Suggested for carpeted surfaces. Available in grey only.

**Ganging Plates**

Ganging plates are available for ganging adjoining tables together. Ganging plates are black epoxy coated steel plates with two thumbscrews.

**Wire Management**

Wire management option is a snap-in channel that fits on the interior of the leg or on the understand of the flip-top cross beam.

**Modesty Panels**

10" Modesty panel affixes to the top and base, articulating when it folds down. available in all standard LP laminate and veneer finishes.

**GFT-R • Rectangular Flip-Top Training Table**



- B and V edge tops have square corners

PRODUCT CODE	PRICE	SIZE/INCHES			WEIGHT		VOL FT³
		H	W	D	LBS		
GFT2448R	1668	29	48	24	48	6	
GFT2454R	1740	29	54	24	53	6	
GFT2460R	1809	29	60	24	55	7	
GFT2466R	1834	29	66	24	61	7	
GFT2472R	1861	29	72	24	66	7	
GFT3048R	1740	29	48	30	53	6	
GFT3054R	1776	29	54	30	55	6	
GFT3060R	1834	29	60	30	61	7	
GFT3066R	1858	29	66	30	66	7	
GFT3072R	1898	29	72	30	68	7	

**GFT-M • Folding Modesty Panel**

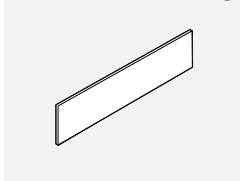

- Includes hardware to connect to Terina Tables.
- Woodgrain modesty panels over 60" will have the woodgrain run horizontally, whereas others will run vertically.
- Due to location of the modesty panel, only MSPDM and GMDSF10 grommets can be used on Terina tables with modesty panels.

PRODUCT CODE	PRICE LP	SIZE/INCHES			WEIGHT		VOL FT³
		H	W	D	LBS		
GFT48M	292	10	46	0.75	11	1	
GFT54M	308	10	52	0.75	13	1	
GFT60M	324	10	58	0.75	15	1	
GFT66M	340	10	64	0.75	18	2	
GFT72M	360	10	70	0.75	20	2	

**GFTCM • Wire Manager**

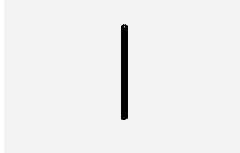

- Set of four
- Each piece is 10" long

PRODUCT CODE	PRICE	SIZE/INCHES			WEIGHT		VOL FT³
		H	W	D	LBS		
GFTCM04BLK	52	2	10	2	1	1	

**GFCNGFP • Ganging Flush Plate**

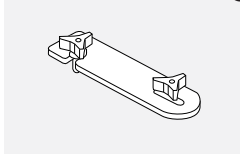

- Please specify application so that inserts may be added to surface.

PRODUCT CODE	PRICE	SIZE/INCHES			WEIGHT		VOL FT³
		H	W	D	LBS		
GFCNGFP	52	2.5	5	0.1	0.22	0.01	





**GUIDELINE FOR ORDERING PRODUCT**

**CODES:** The price list uses a numbering system with meaningful alphanumeric characters to create a simple-to-understand product number. This makes specifying the product much easier and more accurate.

**SPECIFICATION EXAMPLE OF A HEIGHT ADJUSTABLE TABLE**

Ordered as components, please order:

**1. BASE**

**PRODUCT CODE:**

- FT - FreeFit
- 5 - Standard Range Legs
- 2 - Leg Quantity
- SF - Small Frame
- 24 - Depth
- CL - C-leg Style
- S - Standard Controller

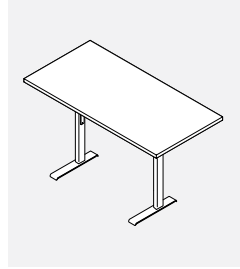

**OPTIONS:**

Frame Style: 5 - Standard Range Frame 27.5" to 47"  
6 - Extended Range Frame 22.5" to 48.5"

Leg Quantity: 1 - 1 Leg for return Kit  
2 - 2 Leg table Kit  
3 - 3 Leg Table Kit  
4 - 4 Leg Table Kit

Frame Size: SF - Small Frame, for 48" to 60" wide Tables  
LF - Large Frame, for 66" to 84" wide Tables

Worksurface Depth: 24 - For 23" deep worksurfaces  
30 - For 29" and 35" deep worksurfaces

Leg Style: CL - C Shaped Table Leg  
TL - T Shaped Table Leg

Controller Style: S - Standard Controller

**Base Finish:**

- BLK - Black
  - DWT - Designer White
  - TUN - Tungsten
- The following finishes are available for minimum orders of 72 legs for special projects. For customer who request the finishes below, and do not meet the 72 legs threshold, a 30% surcharge will apply to the base and an extended lead time of 6 weeks.

- BZD - Blizzard
- CHR - Charcoal
- NEV - Nevada
- SDT - Stonedust
- SIL - Silver
- FOG - Steel
- TPE - Taupe

**2. TOP**

**PRODUCT CODE:**

FTWR2436

Top: LP = LP (Low Pressure Laminate) Thickness 1"  
HP = HP (High Pressure Laminate) Thickness 1 1/16"

Top Finish Laminate: Choose Colour

Top PVC Edging: Choose Colour

**3. ACCESSORIES**

**PRODUCT CODE:**

FTAEC12

**Base Finish:**

- BLK - Black
  - DWT - Designer White
  - TUN - Tungsten
- The following finishes are available for minimum orders of 72 legs for special projects. For customer who request the finishes below, and do not meet the 72 legs threshold, a 30% surcharge will apply to the base and an extended lead time of 6 weeks.

- BZD - Blizzard
- CHR - Charcoal
- NEV - Nevada
- SDT - Stonedust
- SIL - Silver
- FOG - Steel
- TPE - Taupe

## HEIGHT-ADJUSTABLE TABLES • PRODUCT MAP

### C-Leg Base

Standard and Extended Range

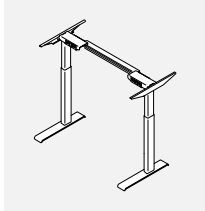

### 90 Degree Retrofit Kit with C-Leg

Standard and Extended Range



### Single Frame

Standard and Extended Range

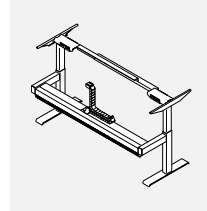

### T-Leg Base

Standard and Extended Range

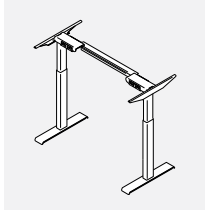

### 90 Degree Retrofit Kit with T-Leg

Standard and Extended Range



### Single End-of-Run Frame

Standard and Extended Range

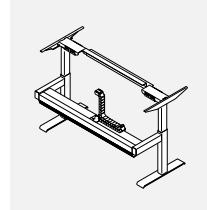

### 90 Degree Table Base

Equal Sides  
Standard and Extended Range

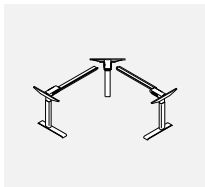

### 120 Degree Table Base

Standard and Extended Range

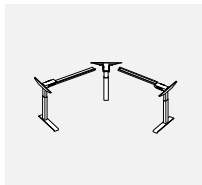

### Media Table Frame

Standard and Extended Range

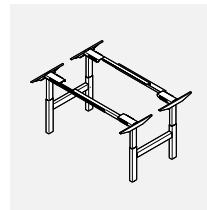

### 90 Degree Table Base, Unequal Sides

Standard and Extended Range

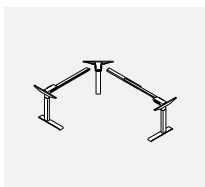

### Back-to-Back Frame

Standard and Extended Range

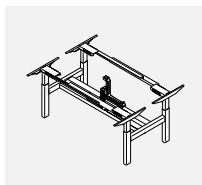

**FREEFIT GROMMET LOCATION**

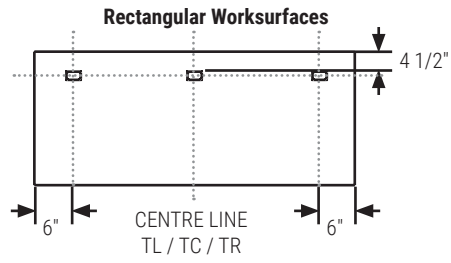
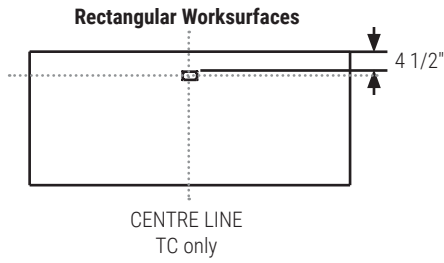

**120° Corner Table Top**

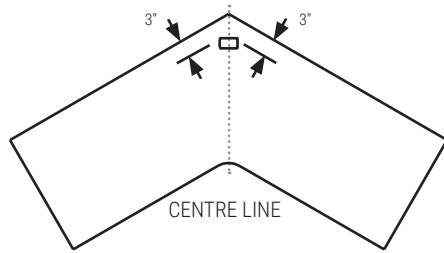

**90° Extended Corner Worksurface**

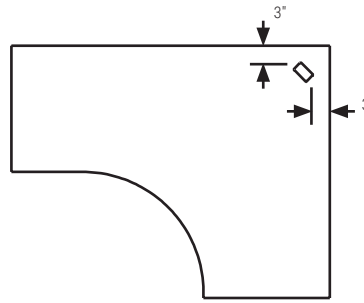

For FTWR worksurfaces 64" and larger, TL/TR, TL/TC and TC/TR are also available.

**GAADxx Grommets Rectangular Worksurface TL**

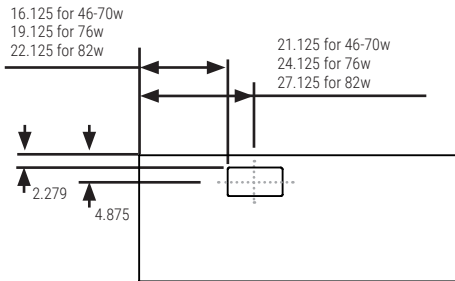

**GAADxx Grommets Rectangular Worksurface TR**

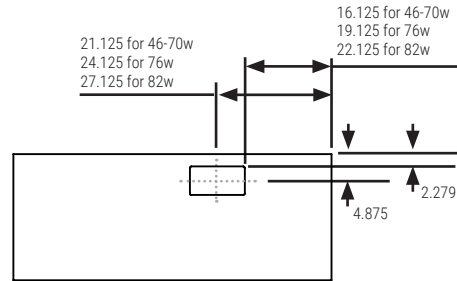

For Back-to-Back Tables and Freestanding Tables only. Not available for return table tops.

**Media Table Tops**

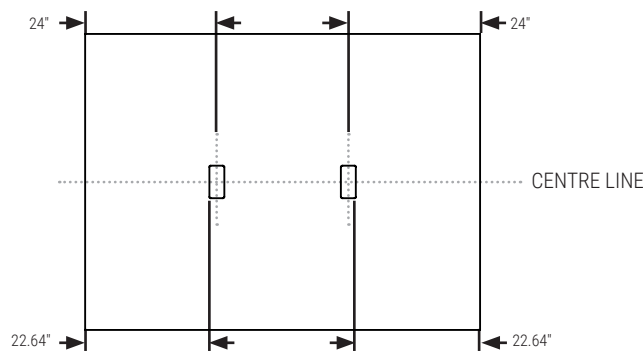

**GENERAL SPECIFICATION****FEATURES**

- Table frames feature 80 X 50 mm rectangular outer leg with the large tube attached to the foot.
- Open base design with ample room for chair and user's legs.
- Flat foot design includes adjustable (10mm) glides.
- All table frames include expandable width upper crossbars to create a variety of size tables.
- Tables have no lower crossbars.
- All table frames are easy to assemble with few parts.
- Tables are designed so that the paint will never mar on the leg during operation.
- Steel construction of the leg assembly tubing, feet and upper structure assemblies.
- Powder coat finishes for bases standard in (DWT) Designer White, (BLK) Black and (TUN) Tungsten.
- All standard Teknion laminate finishes are available.
- Sizes of tops are "nominal". Unless otherwise stated, actual depth is 1" less and actual width is 2" less than "nominal" size.
- Additional Finishes available minimum quantity of 72 legs (36 - 2 leg tables, 24 - 3 leg tables or 18 B2B Tables) Blizzard, Charcoal, Nevada, Silver, Steel, Stonedust, and Taupe
- All bases lift 350 lbs on two leg tables.
- All bases operate at 1.5" per second.
- Standard Range Frame adjusts from 27.5" to 47" including the worksurface.
- Extended Range Frame adjusts from 22.5" to 48.5" including the worksurface.
- Tops are warrantied for lifetime and bases are warrantied for 7 years.

**CERTIFICATIONS**

- Products are fully compliant with ANSI/BIFMA X5.5 – 2014, CAN/CGSB-44.227 - 2017; EN 60335-1 and UL962
- All Teknion Extended Range tables meet the BIFMA G1-2013 Ergonomic Guideline for "recommended adjustment range".

**EXTENDED RANGE COLUMNS**

- The 3-part construction ensures a short installation dimension combined with a long stroke length making the Extended Range Column the optimum choice no matter the height of the person using it. The middle profile of the column moves synchronously so the profiles are always in the same height optimizing the desk design and the stability.
- Compact design where guide and actuator functions are an integrated unit
- Reinforced column and optimized motor housing design for extra strength and stability
- Max. thrust 1200 N per column (12 mm spindle pitch)
- Max. speed 38 mm/s unloaded
- Installation dimension: 560 mm 518 mm (BIFMA)
- Stroke length: 650 mm 665 mm (BIFMA)
- Dimensions column: 50 x 80 mm (outer profile), 43.5 x 73.5 mm (middle profile) and 37 x 67 mm (inner profile)
- Low noise level
- No visible gliding pads

**STANDARD RANGE COLUMNS**

- The 2-part lifting column is a perfect choice for a wide range of different desk applications in the office.
- Compact design where guide and actuator functions are an integrated unit
- Reinforced column and optimized motor housing design for extra strength and stability
- Max. load 800 N per column
- Max. speed: 38 mm/s unloaded
- Standard installation dimension 645 mm
- Standard stroke length 500 mm
- Dimensions column: 50 x 80 mm (outer profile) and 43.5 x 73.5 mm (inner profile)
- Dimension motor housing: 177 x 97 x 46 mm
- Low noise level
- No visible gliding pads

**FOOT**

- FreeFit offers two foot styles either a "T" or "C".
- The feet are available in two different lengths (560 mm and 710 mm). The foot offers a recessed connection for the column and connects from the bottom with 4 bolts. Adjustable glides are standard

**DESK-MOUNT FRAME**

- Can be specified in two lengths Short Frame (SF) for tables 42" – 60" in length. Long Frames (LF) for tables 66"- 84" in length
- All metal parts Black
- Cantilever length: 550 mm
- Central or off-center placement of columns (T-desk and C-desk)
- Includes all connecting hardware

**CONTROL BOX****• Two leg tables come standard with a 200 W Control Box**

- Mains voltage 230 VAC, 50 Hz, or 120 VAC, 60 Hz
- Ultra-compact; length 210 mm length
- Lightweight control box; weight only approx. 400 g

**• Three Leg Tables come standard with a 300 W Control Box**

- can be connected up to 4 columns
- Mains voltage 100-240 VAC, 50-60 Hz (universal)
- Ultra-compact; length 265 mm length
- Lightweight control box; weight only approx. 500 g

**• Common features for the (200 W and 300 W):**

- Ultra-low; height only 38 mm
- Environment: Operation Storage
- Ambient temperature: 5 to 40 °C -10 to +50 °C
- Relative humidity: 20 to 80 % at 30 °C 20 to 80 % at 30 °C
- Atmospheric pressure: 700 to 1060 hPa 700 to 1060 hPa
  - Compact high-power SMPS (Switch Mode Power Supply)
  - Color: black
  - Protection against overload (EOP), by individual current limitation
  - The control box is designed with a soft start/stop function
  - Autodetection of the number and type of columns connected
  - Cable grooves at the bottom to optimize cable management
  - White plugs for easy recognition when mounting/dismounting
  - PVC-Free™
  - Low standby power consumption – only 0.1 W.
  - Exchangeable standard mains cable

**STANDARD UP/DOWN CONTROLLER**

- Features Bluetooth® connection, two favorite positions and a reminder via an LED to remind the users to use their desk. The Controller is activated by tilting the desk panel in the same direction as the desk is intended to drive. Via pulsating green and orange lights, the LED reminds the users to change positions. Using the integrated Bluetooth® and downloading the Desk Control™ App the user can also be reminded via notifications on computers and smart devices.

- Color: Black
- Black cable with RJ45 modular plug, 1700 mm straight
- PVC-Free™
- Featuring ZERO™: Very low power consumption in standby mode
- Approved according to EN 60335-1
- Approved according to UL962

**GENERAL SPECIFICATION ... CONTINUED****DISPLAY UP/DOWN CONTROLLER**

Features Bluetooth® connection, four favorite positions, a display to guide the users and a reminder via a light strip to remind the users to use their desks. The Controller is activated by tilting the desk panel in the same direction as the desk is intended to drive. The Display Controller features a modern discreet design with a glossy surface and an integrated display to ensure a clean and minimalist design. The display provides guidance to the users when operating the desk. Via pulsating green and orange lights, the light strip reminds the users to change positions. Using the integrated Bluetooth® and downloading the Desk Control™ App the users can also be reminded via notifications on smart devices.

- Color: Black
- Black cable with RJ45 modular plug, 1700 mm straight
- PVC-Free™
- Featuring ZERO™: Very low power consumption in standby mode
- Approved according to EN 60335-1
- Approved according to UL962

**ANTI-COLLISION SENSOR**

Features enhanced Anti-Collision protection which can limit material damage to a desk or an object if a collision occurs during driving of the desk. The sensor is a compact plug-in adapter based on gyroscope-technology, and it detects even little tilting of the desk when the desk is driving up or down. Upon detected tilting, the system stops and drives in the opposite direction to avoid collision and damage to the desk or the object. The sensor can detect both hard and soft obstacles. The Anti-Collision Sensor is standard on all desks.

- Reacts to angle changes bigger than 0.7° per second
- Just plug it in – no mounting required
- ZEROTM Power capable
- PVC-Free

**BATTERY BOX**

A high-performance lithium-Ion battery with a capacity of 2.15 Ah. On a full charge the table can cycle from 35 to 45 stroke lengths based upon the range of column selected and load on the table.

- Compact unit for easy handling and installation
- Battery alarm (audio) when charging is needed
- Battery charging indicator (LED light bars) indicating the capacity level
- Thermal switch protection, overcurrent protection
- Color: black
- Battery capacity: 2.15 Ah / 52 Wh
- Nominal voltage: 24 V DC
- Discharge current: 9 A (max)
- Maximum charging voltage: 40 V DC
- Charging current: 0.5 A
- Weight: 600 g

**USAGE**

- Ambient temperature: 5 to 40 °C
- Storage temperature: 0 to 45 °C
- Approved according to:  
EN 62133 (Battery safety testing)  
UL 1642 (Lithium cells, standard test)  
UN 38.3 (transportation of Lithium batteries)  
UL 2054 (Household and commercial batteries)  
EN 60335-1 with CBH Advanced

NOTE: All grommets must be specified separately.

**FT52xxxxCL • Standard Range Base With C-Legs**

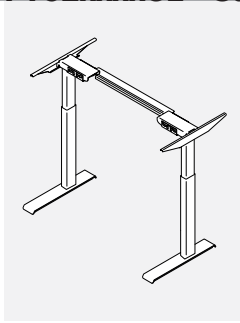

- Kit includes one beam, two cantilevers, two standard range columns and two C styled feet.
- SF indicates small frame for 42" to 60" tables.
- LF indicates large frame: 66" to 84" tables.
- For 23" deep worksurfaces, use 24" CL leg.
- For 29" and 35" deep worksurface, use 30" CL leg.
- For enhanced collision detection an Anti-Collision Desk Sensor included with every base.
- For Standard Up/Down Controller add (S) at the end of the code. For Display Controller, please add at "D" at the end of the product code and \$114 to the list price.
- Specify paint finish: BLK-Black, DWT-Designer White, TUN-Tungsten.

PRODUCT CODE	PRICE	HEIGHT MIN/MAX	WIDTH MIN/MAX	DEPTH MIN/MAX	WEIGHT LBS	VOL FT <sup>3</sup>
FT52SF24CL	2600	27.5" - 47"	42" - 60"	24" - 24"	56.12	2.3
FT52SF30CL	2621	27.5" - 47"	42" - 60"	30" - 36"	56.12	2.3
FT52LF24CL	2610	27.5" - 47"	66" - 84"	24" - 24"	59.3	2.3
FT52LF30CL	2629	27.5" - 47"	66" - 84"	30" - 36"	59.3	2.3

**FT52xxxxTL • Standard Range Base With T-Legs**

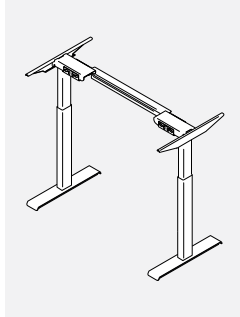

- Kit includes one beam, two cantilevers, two standard range columns and two T styled feet.
- SF indicates small frame for 42" to 60" tables.
- LF indicates large frame: 66" to 84" tables.
- For 23" deep worksurfaces, use 24" TL leg.
- For 29" deep worksurface, use 30" TL leg.
- For enhanced collision detection an Anti-Collision Desk Sensor included with every base.
- For Standard Up/Down Controller add (S) at the end of the code. For Display Controller, please add at "D" at the end of the product code and \$114 to the list price.
- Specify paint finish: BLK-Black, DWT-Designer White, TUN-Tungsten.

PRODUCT CODE	PRICE	HEIGHT MIN/MAX	WIDTH MIN/MAX	DEPTH MIN/MAX	WEIGHT LBS	VOL FT <sup>3</sup>
FT52SF24TL	2537	27.5" - 47"	42" - 60"	24" - 24"	56.12	2.3
FT52SF30TL	2557	27.5" - 47"	42" - 60"	30" - 36"	56.12	2.3
FT52LF24TL	2547	27.5" - 47"	66" - 84"	24" - 24"	59.3	2.3
FT52LF30TL	2567	27.5" - 47"	66" - 84"	30" - 36"	59.3	2.3

**FT62xxxxCL • Extended Range Base With C-Legs**

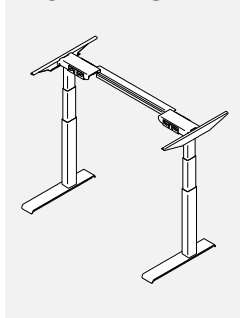

- Kit includes one beam, two cantilevers, two extended range columns and two C styled feet.
- SF indicates small frame for 42" to 60" tables.
- LF indicates large frame: 66" to 84" tables.
- For 23" deep worksurfaces, use 24" CL leg.
- For 29" and 35" deep worksurface, use 30" CL leg.
- For enhanced collision detection an Anti-Collision Desk Sensor included with every base.
- For Standard Up/Down Controller add (S) at the end of the code. For Display Controller, please add at "D" at the end of the product code and \$114 to the list price.
- Specify paint finish: BLK-Black, DWT-Designer White, TUN-Tungsten.

PRODUCT CODE	PRICE	HEIGHT MIN/MAX	WIDTH MIN/MAX	DEPTH MIN/MAX	WEIGHT LBS	VOL FT <sup>3</sup>
FT62SF24CL	2773	22.5" - 48.5"	42" - 60"	24" - 24"	59.3	2.3
FT62SF30CL	2792	22.5" - 48.5"	42" - 60"	30" - 36"	59.3	2.3
FT62LF24CL	2781	22.5" - 48.5"	66" - 84"	24" - 24"	64.7	2.3
FT62LF30CL	2802	22.5" - 48.5"	66" - 84"	30" - 36"	64.7	2.3

**FT62xxxxTL • Extended Range Base With T-Legs**

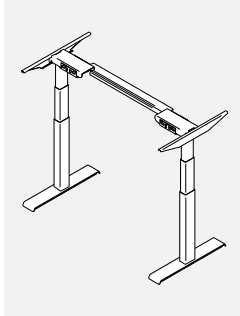

- Kit includes one beam, two cantilevers, two extended range columns and two T styled feet.
- SF indicates small frame for 42" to 60" tables.
- LF indicates large frame: 66" to 84" tables.
- For 23" deep worksurfaces, use 24" TL leg.
- For 29" deep worksurface, use 30" TL leg.
- For enhanced collision detection an Anti-Collision Desk Sensor included with every base.
- For Standard Up/Down Controller add (S) at the end of the code. For Display Controller, please add at "D" at the end of the product code and \$114 to the list price.
- Specify paint finish: BLK-Black, DWT-Designer White, TUN-Tungsten.

PRODUCT CODE	PRICE	HEIGHT MIN/MAX	WIDTH MIN/MAX	DEPTH MIN/MAX	WEIGHT LBS	VOL FT <sup>3</sup>
FT62SF24TL	2710	22.5" - 48.5"	42" - 60"	24" - 24"	59.3	2.3
FT62SF30TL	2730	22.5" - 48.5"	42" - 60"	30" - 36"	59.3	2.3
FT62LF24TL	2719	22.5" - 48.5"	66" - 84"	24" - 24"	64.7	2.3
FT62LF30TL	2738	22.5" - 48.5"	66" - 84"	30" - 36"	64.7	2.3

**FT539FxxxCL • Standard Range 90 Degree Table Base, Equal Sides**

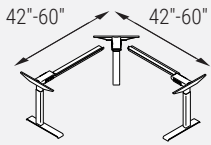

FS Base

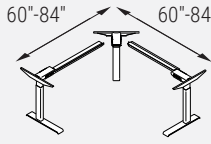

FL Base

- Kit includes two equal length beams, three cantilevers, one standard range corner column, two standard range columns and two C styled feet.

- FS indicates small base for 54" to 60" sided tables.

- FL indicates large base for 66" to 84" sided tables.

- For 23" deep worksurfaces, use 24" CL leg.

- For 29" and 35" deep worksurface, use 30" CL leg.

- For enhanced collision detection an Anti-Collision Desk Sensor included with every base.

- For Standard Up/Down Controller add (S) at the end of the code. For Display Controller, please add at "D" at the end of the product code and \$114 to the list price.

- Specify paint finish: BLK-Black, DWT-Designer White, TUN-Tungsten.

PRODUCT CODE	PRICE	HEIGHT MIN/MAX	WIDTH MIN/MAX	DEPTH MIN/MAX	WEIGHT LBS	VOL FT <sup>3</sup>
FT539FS24CL	3784	27.5" - 47"	42" - 60"	54" - 60"	79.1	4.7
FT539FS30CL	3804	27.5" - 47"	42" - 60"	54" - 60"	79.1	4.7
FT539FL24CL	3852	27.5" - 47"	66" - 84"	66" - 84"	59.3	4.7
FT539FL30CL	3871	27.5" - 47"	66" - 84"	66" - 84"	59.3	4.7

**FT539FSLxxCL • Standard Range 90 Degree Table Base, Unequal Sides**

42" - 60"      66" - 84"  
OR  
42" - 60"      66" - 84"

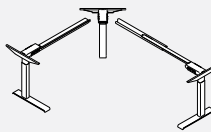

- Kit includes two beams (one small and one large), three cantilevers, one standard range corner column, two standard range columns and two C styled feet.

- For 23" deep worksurfaces, use 24" CL leg.

- For 29" and 35" deep worksurface, use 30" CL leg.

- For enhanced collision detection an Anti-Collision Desk Sensor included with every base.

- For Standard Up/Down Controller add (S) at the end of the code. For Display Controller, please add at "D" at the end of the product code and \$114 to the list price.

- Specify paint finish: BLK-Black, DWT-Designer White, TUN-Tungsten.

PRODUCT CODE	PRICE	HEIGHT MIN/MAX	WIDTH MIN/MAX	DEPTH MIN/MAX	WEIGHT LBS	VOL FT <sup>3</sup>
FT539FSL24CL	3817	27.5" - 47"	42" - 60"	66" - 84"	85.4	4.7
FT539FSL30CL	3837	27.5" - 47"	42" - 60"	66" - 84"	85.4	4.7

**FT639FxxxCL • Extended Range 90 Degree Table Base, Equal Sides**

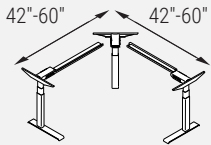

FS Base

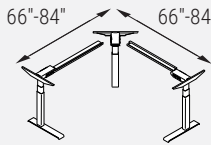

FL Base

- Kit includes two equal length beams, three cantilevers, one extended range corner column, two extended range columns and two C styled feet.

- FS indicates small base for 54" to 60" sided tables.

- FL indicates large base for 66" to 84" sided tables.

- For 23" deep worksurfaces, use 24" CL leg.

- For 29" and 35" deep worksurface, use 30" CL leg.

- For enhanced collision detection an Anti-Collision Desk Sensor included with every base.

- For Standard Up/Down Controller add (S) at the end of the code. For Display Controller, please add at "D" at the end of the product code and \$114 to the list price.

- Specify paint finish: BLK-Black, DWT-Designer White, TUN-Tungsten.

PRODUCT CODE	PRICE	HEIGHT MIN/MAX	WIDTH MIN/MAX	DEPTH MIN/MAX	WEIGHT LBS	VOL FT <sup>3</sup>
FT639FS24CL	4042	22.5" - 48.5"	42" - 60"	48" - 60"	76.5	4.7
FT639FS30CL	4062	22.5" - 48.5"	42" - 60"	48" - 60"	76.5	4.7
FT639FL24CL	4109	22.5" - 48.5"	66" - 84"	66" - 84"	82.7	4.7
FT639FL30CL	4129	22.5" - 48.5"	66" - 84"	66" - 84"	82.7	4.7

**FT639FSLxxCL • Extended Range 90 Degree Table Base, Unequal Sides**

42" - 60"      66" - 84"  
OR  
42" - 60"      66" - 84"

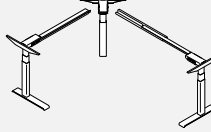

- Kit includes two beams (one small and one large), three cantilevers, one extended range corner column, two extended range columns and two C styled feet.

- For 23" deep worksurfaces, use 24" CL leg.

- For 29" and 35" deep worksurface, use 30" CL leg.

- For enhanced collision detection an Anti-Collision Desk Sensor included with every base.

- For Standard Up/Down Controller add (S) at the end of the code. For Display Controller, please add at "D" at the end of the product code and \$114 to the list price.

- Specify paint finish: BLK-Black, DWT-Designer White, TUN-Tungsten.

PRODUCT CODE	PRICE	HEIGHT MIN/MAX	WIDTH MIN/MAX	DEPTH MIN/MAX	WEIGHT LBS	VOL FT <sup>3</sup>
FT639FSL24CL	4076	22.5" - 48.5"	48" - 60"	48" - 84"	85.4	4.7
FT639FSL30CL	4096	22.5" - 48.5"	48" - 60"	48" - 84"	85.4	4.7

**FT51xRxxCL • Standard Range 90 Degree Table Retrofit Kit With C-Leg**

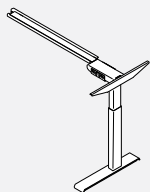

- Kit includes one beam, one cantilever, one standard range column and one C styled foot.

- SR indicates for short returns of 43" to 67" wide.

- LR indicates for long returns of 66" to 84" wide.

- For 23" deep worksurfaces, use 24" CL leg.

- For 29" and 35" deep worksurface, use 30" CL leg.

- Specify paint finish: BLK-Black, DWT-Designer White, TUN-Tungsten.

PRODUCT CODE	PRICE	HEIGHT MIN/MAX	WIDTH MIN/MAX	DEPTH MIN/MAX	WEIGHT LBS	VOL FT <sup>3</sup>
FT51SR24CL	1689	27.5" - 47"	24" - 48"	24" - 24"	24.9	4.7
FT51LR24CL	1723	27.5" - 47"	54" - 72"	24" - 24"	26.9	4.7
FT51SR30CL	1699	27.5" - 47"	24" - 48"	30" - 36"	24.9	4.7
FT51LR30CL	1733	27.5" - 47"	54" - 72"	30" - 36"	26.9	4.7



**FT51xRxxTL • Standard Range 90 Degree Table Retrofit Kit With T-Leg**

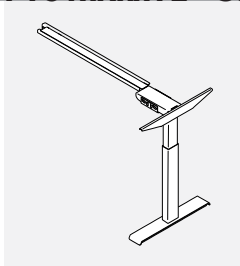

- Kit includes one beam, one cantilever, one standard range column and one T styled foot.
- SR indicates for short returns of 43" to 67" wide.
- LR indicates for long returns of 66" to 84" wide.
- For 23" deep worksurfaces, use 24" TL leg.
- For 29" and 35" deep worksurface, use 30" TL leg.
- Specify paint finish: BLK-Black, DWT-Designer White, TUN-Tungsten.

PRODUCT CODE	PRICE	HEIGHT MIN/MAX	WIDTH MIN/MAX	DEPTH MIN/MAX	WEIGHT LBS	VOL FT <sup>3</sup>
FT51SR24TL	1721	27.5" - 47"	24" - 48"	24" - 24"	24.9	2.3
FT51LR24TL	1754	27.5" - 47"	54" - 72"	24" - 24"	26.9	2.3
FT51SR30TL	1731	27.5" - 47"	24" - 48"	30" - 36"	24.9	2.3
FT51LR30TL	1765	27.5" - 47"	54" - 72"	30" - 36"	26.9	2.3

**FT61xRxxCL • Extended Range 90 Degree Table Retrofit Kit With C-Leg**

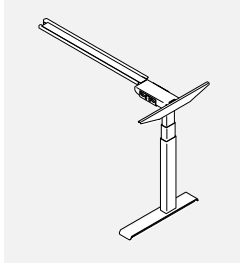

- Kit includes one beam, one cantilever, one extended range column and one C styled foot.
- SR indicates for short returns of 43" to 67" wide.
- LR indicates for long returns of 66" to 84" wide.
- For 23" deep worksurfaces, use 24" CL leg.
- For 29" and 35" deep worksurface, use 30" CL leg.
- Specify paint finish: BLK-Black, DWT-Designer White, TUN-Tungsten.

PRODUCT CODE	PRICE	HEIGHT MIN/MAX	WIDTH MIN/MAX	DEPTH MIN/MAX	WEIGHT LBS	VOL FT <sup>3</sup>
FT61SR24CL	1775	22.5" - 48.5"	24" - 48"	24" - 24"	27.6	4.7
FT61LR24CL	1809	22.5" - 48.5"	54" - 72"	24" - 24"	30.7	4.7
FT61SR30CL	1785	22.5" - 48.5"	24" - 48"	30" - 36"	27.6	4.7
FT61LR30CL	1819	22.5" - 48.5"	54" - 72"	30" - 36"	30.7	4.7

**FT61xRxxTL • Extended Range 90 Degree Table Retrofit Kit With T-Leg**

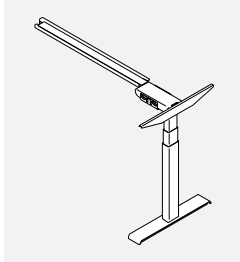

- Kit includes one beam, one cantilever, one extended range column and one T styled foot.
- SR indicates for short returns of 43" to 67" wide.
- LR indicates for long returns of 66" to 84" wide.
- For 23" deep worksurfaces, use 24" TL leg.
- For 29" and 35" deep worksurface, use 30" TL leg.
- Specify paint finish: BLK-Black, DWT-Designer White, TUN-Tungsten.

PRODUCT CODE	PRICE	HEIGHT MIN/MAX	WIDTH MIN/MAX	DEPTH MIN/MAX	WEIGHT LBS	VOL FT <sup>3</sup>
FT61SR24TL	1807	22.5" - 48.5"	24" - 48"	24" - 24"	27.6	2.3
FT61LR24TL	1841	22.5" - 48.5"	54" - 72"	24" - 24"	30.7	2.3
FT61SR30TL	1817	22.5" - 48.5"	24" - 48"	30" - 36"	27.6	2.3
FT61LR30TL	1851	22.5" - 48.5"	54" - 72"	30" - 36"	30.7	2.3

**FT531FxxxCL • Standard Range 120 Degree Table Base, Equal Sides**

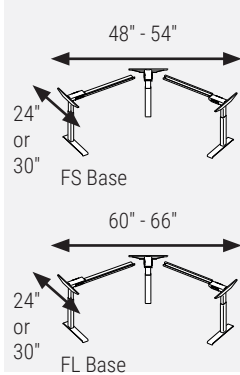

- Kit includes two beams, three cantilevers, one standard range corner column, two standard range columns and two C styled feet.
- FS indicates small base for 48" to 54" sided tables.
- FL indicates large base for 60" to 66" sided tables.
- For 23" deep worksurfaces, use 24" CL leg.
- For 29" and 35" deep worksurface, use 30" CL leg.
- For enhanced collision detection an Anti-Collision Desk Sensor included with every base.
- For Standard Up/Down Controller add (S) at the end of the code. For Display Controller, please add at "D" at the end of the product code and \$114 to the list price.
- Specify paint finish: BLK-Black, DWT-Designer White, TUN-Tungsten.

PRODUCT CODE	PRICE	HEIGHT MIN/MAX	WIDTH MIN/MAX	DEPTH MIN/MAX	WEIGHT LBS	VOL FT <sup>3</sup>
FT531FS24CL	3784	27.5" - 47"	48" - 54"	48" - 54"	59.7	4.7
FT531FS30CL	3804	27.5" - 47"	48" - 54"	48" - 54"	59.7	4.7
FT531FL24CL	3852	27.5" - 47"	60" - 66"	60" - 66"	59.7	4.7
FT531FL30CL	3871	27.5" - 47"	60" - 66"	60" - 66"	59.7	4.7

**FT631FxxxCL • Extended Range 120 Degree Table Base, Equal Sides**

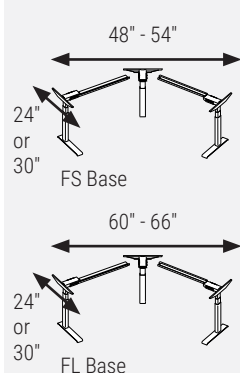

- Kit includes two beams, three cantilevers, one extended range corner column, two extended range columns and two C styled feet.
- FS indicates small base for 48" to 54" sided tables.
- FL indicates large base for 60" to 66" sided tables.
- For 23" deep worksurfaces, use 24" CL leg.
- For 29" and 35" deep worksurface, use 30" CL leg.
- For enhanced collision detection an Anti-Collision Desk Sensor included with every base.
- For Standard Up/Down Controller add (S) at the end of the code. For Display Controller, please add at "D" at the end of the product code and \$114 to the list price.
- Specify paint finish: BLK-Black, DWT-Designer White, TUN-Tungsten.

PRODUCT CODE	PRICE	HEIGHT MIN/MAX	WIDTH MIN/MAX	DEPTH MIN/MAX	WEIGHT LBS	VOL FT <sup>3</sup>
FT631FS24CL	4042	22.5" - 48.5"	48" - 54"	48" - 54"	59.7	4.7
FT631FS30CL	4062	22.5" - 48.5"	48" - 54"	48" - 54"	59.7	4.7
FT631FL24CL	4109	22.5" - 48.5"	60" - 66"	60" - 66"	59.7	4.7
FT631FL30CL	4129	22.5" - 48.5"	60" - 66"	60" - 66"	59.7	4.7

**FT5B2Bxx • Back-to-Back Standard Range Base**

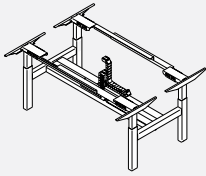

- Kit includes two beams, four cantilevers, four standard range columns and one power trough assembly with two energy chains.
- For 50.5 depth, use two x 23" deep worksurfaces.
- For 62.5" depth, use two x 29" deep worksurfaces.
- 30" or larger depth worksurfaces cannot be used with Back-to-Back bases.
- Duplex receptacles are not included, please specify separately.
- For enhanced collision detection an Anti-Collision Desk Sensor included with every base.
- For Standard Up/Down Controller add (S) at the end of the code. For Display Controller, please add at "D" at the end of the product code and \$228 to the list price.
- Specify paint finish: BLK-Black, DWT-Designer White, TUN-Tungsten.

PRODUCT CODE	PRICE	HEIGHT MIN/MAX	WIDTH MIN/MAX	DEPTH MIN/MAX	WEIGHT LBS	VOL FT <sup>3</sup>
FT5B2B48	7161	27.5" - 47"	48" - 48"	50.5" - 62.5"	129	4.7
FT5B2B54	7212	27.5" - 47"	54" - 54"	50.5" - 62.5"	129	4.7
FT5B2B60	7292	27.5" - 47"	60" - 60"	50.5" - 62.5"	129	4.7
FT5B2B66	7344	27.5" - 47"	66" - 66"	50.5" - 62.5"	129	4.7
FT5B2B72	7362	27.5" - 47"	72" - 84"	50.5" - 62.5"	129	4.7

**FT6B2Bxx • Back-to-Back Extended Range Base**

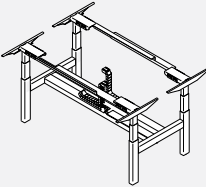

- Kit includes two beams, four cantilevers, four extended range columns and one power trough assembly with two energy chains.
- For 50.5 depth, use two x 23" deep worksurfaces.
- For 62.5" depth, use two x 29" deep worksurfaces.
- 30" or larger depth worksurfaces cannot be used with Back-to-Back bases.
- Duplex receptacles are not included, please specify separately.
- For enhanced collision detection an Anti-Collision Desk Sensor included with every base.
- For Standard Up/Down Controller add (S) at the end of the code. For Display Controller, please add at "D" at the end of the product code and \$228 to the list price.
- Specify paint finish: BLK-Black, DWT-Designer White, TUN-Tungsten.

PRODUCT CODE	PRICE	HEIGHT MIN/MAX	WIDTH MIN/MAX	DEPTH MIN/MAX	WEIGHT LBS	VOL FT <sup>3</sup>
FT6B2B48	7489	22.5" - 48.5"	48" - 48"	50.5" - 62.5"	129	4.7
FT6B2B54	7540	22.5" - 48.5"	54" - 54"	50.5" - 62.5"	129	4.7
FT6B2B60	7620	22.5" - 48.5"	60" - 60"	50.5" - 62.5"	129	4.7
FT6B2B66	7671	22.5" - 48.5"	66" - 66"	50.5" - 62.5"	129	4.7
FT6B2B72	7690	22.5" - 48.5"	72" - 84"	50.5" - 62.5"	129	4.7

**FT5SGLxxTxx • Standard Range Single Frame**

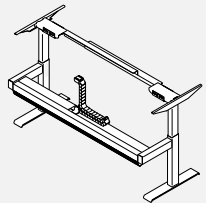

- Kit includes one beam, two cantilevers, two standard range columns, two T styled feet and one power trough assembly with one energy chains.
- For T24 leg, use 23" deep worksurfaces.
- For T30 leg, use 29" deep worksurfaces.
- 30" or larger depth worksurfaces cannot be used with Back-to-Back bases.
- Duplex receptacles are not included, please specify separately.
- For enhanced collision detection an Anti-Collision Desk Sensor included with every base.
- For Standard Up/Down Controller add (S) at the end of the code. For Display Controller, please add at "D" at the end of the product code and \$114 to the list price.
- Specify paint finish: BLK-Black, DWT-Designer White, TUN-Tungsten.

PRODUCT CODE	PRICE	HEIGHT MIN/MAX	WIDTH MIN/MAX	DEPTH MIN/MAX	WEIGHT LBS	VOL FT <sup>3</sup>
FT5SGL48T24	4197	27.5" - 47"	48" - 48"	24" - 24"	75	2.3
FT5SGL54T24	4243	27.5" - 47"	54" - 54"	24" - 24"	75	2.3
FT5SGL60T24	4301	27.5" - 47"	60" - 60"	24" - 24"	75	2.3
FT5SGL66T24	4344	27.5" - 47"	66" - 66"	24" - 24"	75	2.3
FT5SGL72T24	4378	27.5" - 47"	72" - 84"	24" - 24"	75	2.3
FT5SGL48T30	4216	27.5" - 47"	48" - 48"	30" - 30"	75	2.3
FT5SGL54T30	4263	27.5" - 47"	54" - 54"	30" - 30"	75	2.3
FT5SGL60T30	4322	27.5" - 47"	60" - 60"	30" - 30"	75	2.3
FT5SGL66T30	4363	27.5" - 47"	66" - 66"	30" - 30"	75	2.3
FT5SGL72T30	4398	27.5" - 47"	72" - 84"	30" - 30"	75	2.3

**FT6SGLxxTxx • Extended Range Single Frame**

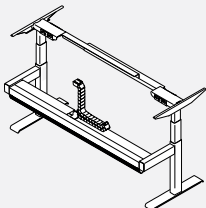

- Kit includes one beam, two cantilevers, two extended range columns, two T styled feet and one power trough assembly with one energy chains.
- For T24 leg, use 23" deep worksurfaces.
- For T30 leg, use 29" deep worksurfaces.
- 30" or larger depth worksurfaces cannot be used with Back-to-Back bases.
- Duplex receptacles are not included, please specify separately.
- For enhanced collision detection an Anti-Collision Desk Sensor included with every base.
- For Standard Up/Down Controller add (S) at the end of the code. For Display Controller, please add at "D" at the end of the product code and \$114 to the list price.
- Specify paint finish: BLK-Black, DWT-Designer White, TUN-Tungsten.

PRODUCT CODE	PRICE	HEIGHT MIN/MAX	WIDTH MIN/MAX	DEPTH MIN/MAX	WEIGHT LBS	VOL FT <sup>3</sup>
FT6SGL48T24	4361	22.5" - 48.5"	48" - 48"	24" - 24"	75	2.3
FT6SGL54T24	4408	22.5" - 48.5"	54" - 54"	24" - 24"	75	2.3
FT6SGL60T24	4465	22.5" - 48.5"	60" - 60"	24" - 24"	75	2.3
FT6SGL66T24	4508	22.5" - 48.5"	66" - 66"	24" - 24"	75	2.3
FT6SGL72T24	4541	22.5" - 48.5"	72" - 84"	24" - 24"	75	2.3
FT6SGL48T30	4381	22.5" - 48.5"	48" - 48"	30" - 30"	75	2.3
FT6SGL54T30	4427	22.5" - 48.5"	54" - 54"	30" - 30"	75	2.3
FT6SGL60T30	4485	22.5" - 48.5"	60" - 60"	30" - 30"	75	2.3
FT6SGL66T30	4528	22.5" - 48.5"	66" - 66"	30" - 30"	75	2.3
FT6SGL72T30	4561	22.5" - 48.5"	72" - 84"	30" - 30"	75	2.3

**FT5SGLxxTxx • Standard Range End-of-Run Single Frame**

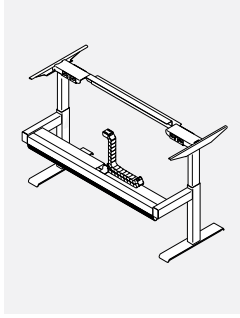

- Kit includes one beam, two cantilevers, two standard range columns, two T styled feet and one power trough assembly with one energy chains.
- For T24 leg, use 23" deep worksurfaces.
- For T30 leg, use 29" deep worksurfaces.
- 30" or larger depth worksurfaces cannot be used with Back-to-Back bases.
- Duplex receptacles are not included, please specify separately.
- For enhanced collision detection an Anti-Collision Desk Sensor included with every base.
- For Standard Up/Down Controller add (S) at the end of the code. For Display Controller, please add at "D" at the end of the product code and \$114 to the list price.
- Specify paint finish: BLK-Black, DWT-Designer White, TUN-Tungsten.

PRODUCT CODE	PRICE	HEIGHT MIN/MAX	WIDTH MIN/MAX	DEPTH MIN/MAX	WEIGHT LBS	VOL FT <sup>3</sup>
FT5SGL51T24	4575	27.5" - 47"	51" - 62"	24" - 24"	75	2.3
FT5SGL51T30	4595	27.5" - 47"	51" - 62"	30" - 30"	75	2.3

**FT6SGLxxTxx • Extended Range End-of-Run Single Frame**

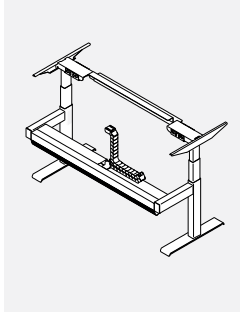

- Kit includes one beam, two cantilevers, two extended range columns, two T styled feet and one power trough assembly with one energy chains.
- For T24 leg, use 23" deep worksurfaces.
- For T30 leg, use 29" deep worksurfaces.
- 30" or larger depth worksurfaces cannot be used with Back-to-Back bases.
- Duplex receptacles are not included, please specify separately.
- For enhanced collision detection an Anti-Collision Desk Sensor included with every base.
- For Standard Up/Down Controller add (S) at the end of the code. For Display Controller, please add at "D" at the end of the product code and \$114 to the list price.
- Specify paint finish: BLK-Black, DWT-Designer White, TUN-Tungsten.

PRODUCT CODE	PRICE	HEIGHT MIN/MAX	WIDTH MIN/MAX	DEPTH MIN/MAX	WEIGHT LBS	VOL FT <sup>3</sup>
FT6SGL51T24	4739	22.5" - 48.5"	51" - 62"	24" - 24"	75	2.3
FT6SGL51T30	4759	22.5" - 48.5"	51" - 62"	30" - 30"	75	2.3

**FTM5B2BxF • Standard Range Media Table Base**

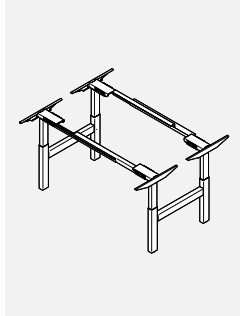

- Kit includes two beams, four cantilevers, four standard range columns and two controllers.
- SF indicates small base for 60" sided tables.
- LF indicates large base for 66" to 96" sided tables.
- Duplex receptacles are not included, please specify separately.
- For enhanced collision detection an Anti-Collision Desk Sensor included with every base.
- For Standard Up/Down Controller add (S) at the end of the code. For Display Controller, please add at "D" at the end of the product code and \$228 to the list price.
- Specify paint finish: BLK-Black, DWT-Designer White, TUN-Tungsten.

PRODUCT CODE	PRICE	HEIGHT MIN/MAX	WIDTH MIN/MAX	DEPTH MIN/MAX	WEIGHT LBS	VOL FT <sup>3</sup>
FTM5B2BSF	5852	27.5" - 47"	60" - 60"	54" - 60"	129	4.7
FTM5B2BLF	5872	27.5" - 47"	66" - 96"	54" - 60"	129	4.7

**FTM6B2BxF • Extended Range Media Table Base**

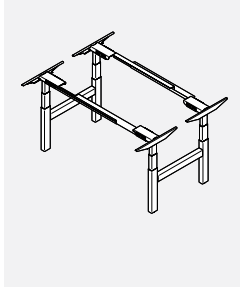

- Kit includes two beams, four cantilevers, four extended range columns and two controllers.
- SF indicates small base for 60" sided tables.
- LF indicates large base for 66" to 96" sided tables.
- Duplex receptacles are not included, please specify separately.
- For enhanced collision detection an Anti-Collision Desk Sensor included with every base.
- For Standard Up/Down Controller add (S) at the end of the code. For Display Controller, please add at "D" at the end of the product code and \$228 to the list price.
- Specify paint finish: BLK-Black, DWT-Designer White, TUN-Tungsten.

PRODUCT CODE	PRICE	HEIGHT MIN/MAX	WIDTH MIN/MAX	DEPTH MIN/MAX	WEIGHT LBS	VOL FT <sup>3</sup>
FTM6B2BSF	6180	22.5" - 48.5"	60" - 60"	54" - 60"	129	4.7
FTM6B2BLF	6198	22.5" - 48.5"	66" - 96"	54" - 60"	129	4.7

**FTWR - Rectangular Worksurface**

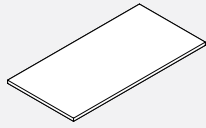

- Rectangular worksurfaces are non-handed and can be interchanged on site.
- Specify laminate finish and PVC edge finish.
- Grommet option for surfaces less than 64" is TC - Top Center only.
- Specification:
- For 23" deep worksurfaces, use FT52(S/L)F24CL/TL standard range or FT62(S/L)F24CL/TL extended range base.
- For 29" deep worksurfaces, use FT52(S/L)F30CL/TL standard range or FT62(S/L)F30CL/TL extended range base.
- For 35" deep worksurfaces, use FT5(S/L)F30CL/TL standard range or FT6(S/L)F30CL/TL extended range base.
- The 35" deep worksurfaces cannot be used with Back-to-Back Bases.
- For Back-to-Back bases, please use the following chart:  
FTW(23/29)46, FT(5/6)B2B48  
FTW(23/29)52, FT(5/6)B2B54  
FTW(23/29)58, FT(5/6)B2B60  
FTW(23/29)64, FT(5/6)B2B66  
FTW(23/29)72, FT(5/6)B2B72  
FTW(23/29)76, FT(5/6)B2B72  
FTW(23/29)82, FT(5/6)B2B72

PRODUCT CODE	FINISH		SIZE/INCHES			WEIGHT LBS	VOL FT <sup>3</sup>
	LP	HP	H	W	D		
FTWR2346	341	455	1	46	23	31	1.84
FTWR2352	401	530	1	52	23	36	2.08
FTWR2358	452	597	1	58	23	40	2.32
FTWR2364	471	622	1	64	23	44	2.56
FTWR2370	492	652	1	70	23	48	3.80
FTWR2376	529	695	1	76	23	52	3.03
FTWR2382	571	746	1	82	23	56	3.27
FTWR2946	401	530	1	46	29	40	2.32
FTWR2952	438	567	1	52	29	45	2.62
FTWR2958	471	622	1	58	29	50	2.92
FTWR2964	489	651	1	64	29	55	3.22
FTWR2970	519	687	1	70	29	60	3.52
FTWR2976	552	725	1	76	29	65	3.83
FTWR2982	615	805	1	82	29	71	4.13
FTWR3546	525	654	1	46	35	48	2.80
FTWR3552	582	729	1	52	35	54	3.16
FTWR3558	647	806	1	58	35	60	3.52
FTWR3564	706	884	1	64	35	67	3.89
FTWR3570	766	957	1	70	35	73	4.25
FTWR3576	824	1031	1	76	35	79	4.62
FTWR3582	887	1108	1	82	35	85	4.98

**FTWRR - Rectangular Return Worksurface**

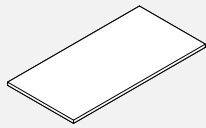

- Rectangular return worksurfaces are non-handed and can be interchanged on site.
- Specify laminate finish and PVC edge finish.
- Includes two flat brackets for connection.
- Specification:
- For 23" deep worksurfaces, use FT51SR24CL/TL standard range or FT61SR24CL/TL extended range base.
- For 29" deep worksurfaces, use FT51SR30CL/TL standard range or FT61SR30CL/TL extended range base.

PRODUCT CODE	FINISH		SIZE/INCHES			WEIGHT LBS	VOL FT <sup>3</sup>
	LP	HP	H	W	D		
FTWRR2329	206	265	1	29	23	20	1.16
FTWRR2335	228	298	1	35	23	24	1.40
FTWRR2341	295	389	1	41	23	28	1.64
FTWRR2347	352	466	1	47	23	32	1.88
FTWRR2353	412	541	1	53	23	36	2.12
FTWRR2359	463	608	1	59	23	40	2.36
FTWRR2929	239	313	1	29	29	25	1.46
FTWRR2935	280	367	1	35	29	30	1.76
FTWRR2941	393	514	1	41	29	35	2.06
FTWRR2947	412	541	1	47	29	40	2.36
FTWRR2953	449	578	1	53	29	46	2.67
FTWRR2959	482	633	1	59	29	51	2.97

**FTWR - Rectangular End-of-Run Worksurface**

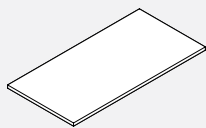

- Rectangular End-of-Run worksurfaces are non-handed and can be interchanged on site.
- Specify laminate finish and PVC edge finish.
- Specification:
- For 23" deep worksurfaces, use FT52(S/F)L24CL/TL standard range or FT62(S/F)L24CL/TL extended range base.
- For 29" deep worksurfaces, use FT52(S/F)L30CL/TL standard range or FT62(S/F)L30CL/TL extended range base.
- For Back-to-Back bases, please use the following chart:  
FTWR(23/29)51, FT(5/6)B2B60  
FTWR(23/29)62, FT(5/6)B2B66

PRODUCT CODE	FINISH		SIZE/INCHES			WEIGHT LBS	VOL FT <sup>3</sup>
	LP	HP	H	W	D		
FTWR2351	452	597	1	51	23	40	2.02
FTWR2362	471	622	1	62	23	44	2.5
FTWR2951	471	622	1	51	29	50	2.54
FTWR2962	489	651	1	62	29	55	3.15

**FTWCC - 90 Degree Corner Worksurface**

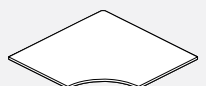

- 90 Corner Worksurface.
- Specify laminate finish and PVC edge finish.
- Specification:
- For tables that connect with 23" deep worksurfaces, use FT539FS24CL standard range or FT539FS24CL extended range base.
- For table that connect with 29" deep worksurfaces, use FT539FS30CL standard range or FT639FS30CL extended range base.

PRODUCT CODE	FINISH		SIZE/INCHES			WEIGHT LBS	VOL FT <sup>3</sup>
	LP	HP	H	W	D		
FTWCC235223	897	987	1	52	52	80	4.69
FTWCC235823	1148	1263	1	58	58	100	5.84
FTWCC294629	760	836	1	46	46	63	3.67
FTWCC295229	897	987	1	52	52	80	4.69
FTWCC295829	1148	1263	1	58	58	100	5.84

LP = Thermally Fused Laminate, HP = High Pressure Laminate.

**FTWEC - Left Extended 90 Degree Corner Worksurface**

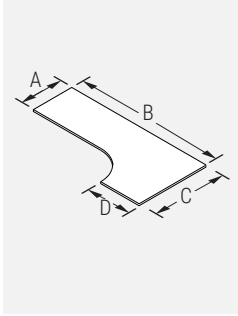

- Left Extended 90 Degree Corner Worksurface.
- Specify laminate finish and PVC edge finish.
- Specification:
- For tables that connect with 23" deep (A and D) worksurfaces, use FT539F(S/L)24CL standard range or FT639F(S/L)24CL extended range base.
- For table that connect with 29" deep (A and D) worksurfaces, use FT539F(S/L)30CL standard range or FT639F(S/L)30CL extended range base.

**NOTE: FTWEC**

A	B	C	D
DEPTH	LENGTH	WIDTH	DEPTH

PRODUCT CODE	FINISH		SIZE/INCHES			WEIGHT LBS	VOL FT <sup>3</sup>
	LP	HP	H	W	D		
FTWEC23584623	1059	1324	1	46	58	115	2.55
FTWEC23644623	1177	1472	1	46	64	127	2.81
FTWEC23704623	1288	1612	1	46	70	138	3.07
FTWEC23764623	1373	1715	1	46	76	150	3.34
FTWEC23824623	1457	1821	1	46	82	162	3.60
FTWEC23585223	1090	1364	1	52	58	130	2.88
FTWEC23645223	1211	1515	1	52	64	143	3.18
FTWEC23705223	1326	1659	1	52	70	156	3.48
FTWEC23765223	1415	1765	1	52	76	170	3.77
FTWEC23825223	1500	1876	1	52	82	183	4.07
FTWEC23645823	1248	1560	1	58	64	160	3.54
FTWEC23705823	1365	1709	1	58	70	174	3.88
FTWEC23765823	1457	1819	1	58	76	189	4.21
FTWEC23825823	1545	1932	1	58	82	204	4.54
FTWEC29584629	1059	1324	1	46	58	115	2.55
FTWEC29644629	1177	1472	1	46	64	127	2.81
FTWEC29704629	1288	1612	1	46	70	138	3.07
FTWEC29764629	1373	1715	1	46	76	150	3.34
FTWEC29824629	1457	1821	1	46	82	152	3.60
FTWEC29585229	1090	1364	1	52	58	130	2.88
FTWEC29645229	1211	1515	1	52	64	143	3.18
FTWEC29705229	1326	1659	1	52	70	156	3.48
FTWEC29765229	1415	1765	1	52	76	170	3.77
FTWEC29825229	1500	1876	1	52	82	183	4.07
FTWEC29645829	1248	1560	1	58	64	160	3.54
FTWEC29705829	1365	1709	1	58	70	174	3.88
FTWEC29765829	1457	1819	1	58	76	189	4.21
FTWEC29825829	1545	1932	1	58	82	204	4.54

**FTWEC • Right Extended 90 Degree Corner Worksurface**

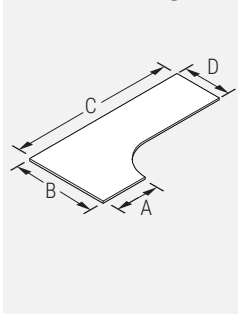

- Right Extended 90 Degree Corner Worksurface.
- Specify laminate finish and PVC edge finish.
- Specification:
- For tables that connect with 23" deep (A and D) worksurfaces, use FT539F(S/L)24CL standard range or FT539F(S/L)24CL extended range base.
- For table that connect with 29" deep (A and D) worksurfaces, use FT539F(S/L)30CL standard range or FT639F(S/L)30CL extended range base.

**NOTE: FTWEC**

A	B	C	D
DEPTH	WIDTH	LENGTH	DEPTH

PRODUCT CODE	FINISH		SIZE/INCHES			WEIGHT LBS	VOL FT <sup>3</sup>
	LP	HP	H	W	D		
FTWEC23465823	1101	1377	1	46	58	115	2.55
FTWEC23466423	1224	1529	1	46	64	127	2.81
FTWEC23467023	1338	1675	1	46	70	138	3.07
FTWEC23467623	1429	1782	1	46	76	150	3.34
FTWEC23468223	1515	1894	1	46	82	162	3.60
FTWEC23525823	1134	1418	1	52	58	130	2.88
FTWEC23526423	1261	1576	1	52	64	143	3.18
FTWEC23527023	1378	1726	1	52	70	156	3.48
FTWEC23527623	1472	1836	1	52	76	170	3.77
FTWEC23528223	1560	1950	1	52	82	183	4.07
FTWEC23586423	1299	1623	1	58	64	160	3.54
FTWEC23587023	1420	1777	1	58	70	174	3.88
FTWEC23587623	1516	1891	1	58	76	189	4.21
FTWEC23588223	1607	2009	1	58	82	204	4.54
FTWEC29465829	1101	1377	1	46	58	115	2.55
FTWEC29466429	1224	1529	1	46	64	127	2.81
FTWEC29467029	1338	1675	1	46	70	138	3.07
FTWEC29467629	1429	1782	1	46	76	150	3.34
FTWEC29468229	1515	1894	1	46	82	162	3.60
FTWEC29525829	1134	1418	1	52	58	130	2.88
FTWEC29526429	1261	1576	1	52	64	143	3.18
FTWEC29527029	1378	1726	1	52	70	156	3.48
FTWEC29527629	1472	1836	1	52	76	170	3.77
FTWEC29528229	1560	1950	1	52	82	183	4.07
FTWEC29586429	1299	1623	1	58	64	160	3.54
FTWEC29587029	1420	1777	1	58	70	174	3.88
FTWEC29587629	1516	1891	1	58	76	189	4.21
FTWEC29588229	1607	2009	1	58	82	204	4.54

LP = Thermally Fused Laminate, HP = High Pressure Laminate.

**FTWRE • Rectangular Extension Return Worksurface**

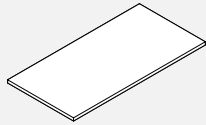

- Worksurfaces to be used only with Extended 90 Degree Corner Worksurfaces.
- Rectangular Extension Return Worksurface.
- Specify laminate finish and PVC edge finish.
- Includes 2 flat brackets for connection.
- Specification:
- FTWRE23 to be used with FTWEC23xxxx23.
- FTWRE29 to be used with FTWEC29xxxx29.

PRODUCT CODE	FINISH		SIZE / INCHES				WEIGHT		VOL FT <sup>3</sup>
	LP	HP	H	W	D	LBS			
FTWRE2324	190	250	1	24	23	16	0.96		
FTWRE2330	206	265	1	30	23	20	1.20		
FTWRE2336	228	298	1	36	23	25	1.44		
FTWRE2924	225	291	1	24	29	21	1.21		
FTWRE2930	239	313	1	30	29	26	1.51		
FTWRE2936	280	367	1	36	29	31	1.81		

**FTWTC • 120 Degree Corner Worksurface**

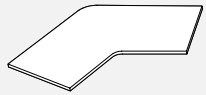

- 120 Degree Corner Worksurface.
- Specify laminate finish and PVC edge finish.
- Specification:
- For tables that connect with 23" deep (A and C) worksurfaces, use FT531F(S/L)24CL standard range or FT531F(S/L)24CL extended range base.
- For table that connect with 29" deep (A and C) worksurfaces, use FT531F(S/L)30CL standard range or FT631F(S/L)30CL extended range.

PRODUCT CODE	FINISH		SIZE / INCHES				WEIGHT		VOL FT <sup>3</sup>
	LP	HP	H	W	D	LBS			
FTWTC234623	1072	1494	1	46	23	165	3.67		
FTWTC235223	1072	1494	1	52	23	211	4.69		
FTWTC235823	1926	2720	1	58	23	263	5.84		
FTWTC236423	1926	2720	1	64	23	320	7.11		
FTWTC294629	1072	1494	1	46	29	165	3.67		
FTWTC295229	1072	1494	1	52	29	211	4.69		
FTWTC295829	1926	2720	1	58	29	263	5.84		
FTWTC296429	1926	2720	1	64	29	320	7.10		

**FTWMR • Media Table Top**

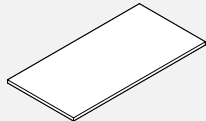

- Media Table Top.
- Specify laminate finish and PVC edge finish.
- Specification:
- For tables FTWMR5460 and 6060, use FTM5B2BSF standard range or FTM6B2BSF extended range base.
- For all other tables, use FTM5B2BLF standard range or FTM6B2BLF extended range base.

PRODUCT CODE	FINISH		SIZE / INCHES				WEIGHT		VOL FT <sup>3</sup>
	LP	HP	H	W	D	LBS			
FTWMR5460	771	1068	1	60	54	96	5.63		
FTWMR5466	841	1167	1	66	54	106	6.19		
FTWMR5472	911	1268	1	72	54	115	6.75		
FTWMR5478	981	1367	1	78	54	125	7.31		
FTWMR5484	1051	1467	1	84	54	135	7.88		
FTWMR5490	1121	1567	1	90	54	144	8.44		
FTWMR5496	1191	1667	1	96	54	154	9.00		
FTWMR6060	848	1178	1	60	60	107	6.25		
FTWMR6066	924	1289	1	66	60	118	6.88		
FTWMR6072	1002	1398	1	72	60	128	7.50		
FTWMR6078	1079	1509	1	78	60	139	8.13		
FTWMR6084	1156	1619	1	84	60	150	8.75		
FTWMR6090	1232	1729	1	90	60	160	9.38		
FTWMR6096	1310	1839	1	96	60	171	10.00		

**FTMT5145 • TV Mount**

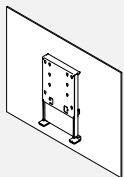

- TV Mount for FreeFit Media Tables.
- Includes the TV/Display bracket and mounting hardware.
- Maximum TV size is 50".
- Back panel is made of PET Felt.

PRODUCT CODE	FINISH	SIZE / INCHES			WEIGHT		VOL FT <sup>3</sup>
		H	W	D	LBS		
FTMT5145	924	40.5	51	4	16.82	4.8	

**FTBxxL • Laminate Leg Shroud for C-Leg, Left**

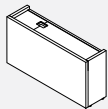

- Laminate shroud for a FreeFit C-Leg on the left side.
- Includes a felt liner at the top.
- Short side panel is removable to access interior.
- Please specify low pressure laminate, PVC edge and felt finishes.

PRODUCT CODE	FINISH LP	SIZE / INCHES			WEIGHT		VOL FT <sup>3</sup>
		H	W	D	LBS		
FTB23L	720	18	23	9	47	2	
FTB29L	752	18	29	9	55	3	
FTB35L	784	18	35	9	67	3	

LP = Thermally Fused Laminate, HP = High Pressure Laminate.

**FTBxxR • Laminate Leg Shroud for C-Leg, Right**

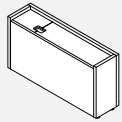

- Laminate housing to cover a FreeFit C-Leg on the right side.
- Includes a felt liner at the top.
- Short side panel is removable to access interior.
- Please specify low pressure laminate, PVC edge and felt finishes.

PRODUCT CODE	FINISH LP	SIZE/INCHES			WEIGHT LBS	VOL FT <sup>3</sup>
		H	W	D		
FTB23R	720	18	23	9	47	2
FTB29R	752	18	29	9	55	3
FTB35R	784	18	35	9	67	3

**FTBxx • Laminate Housing for T-Leg**

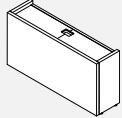

- Laminate housing to cover a FreeFit T-Leg.
- Includes a felt liner at the top.
- Short side panel is removable to access interior.
- Please specify low pressure laminate, PVC edge and felt finishes.

PRODUCT CODE	FINISH LP	SIZE/INCHES			WEIGHT LBS	VOL FT <sup>3</sup>
		H	W	D		
FTB23	720	18	23	9	47	2
FTB29	752	18	29	9	55	3
FTB35	784	18	35	9	67	3

**FTBxx • Laminate Leg Shroud for Media Bases**

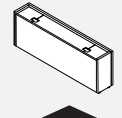

**NEW!**

- Includes a felt liner at the top.
- Side panel is removable to access the interior.
- Please specify low pressure laminate, PVC edging and felt finish.

PRODUCT CODE	FINISH LP	SIZE/INCHES			WEIGHT LBS	VOL FT <sup>3</sup>
		H	W	D		
FTB54	1168	18	54	9	110	5
FTB60	1355	18	60	9	134	6

**FTCRBFO • Credenza, Box/File / Open**

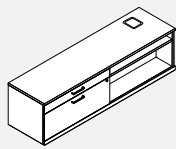

**NEW!**

- Credenza storage with grommet to accommodate a FreeFit C leg base.
- Recommended for use with the standard range bases only.
- One lock included
- One adjustable Shelf
- Select any standard Licence2 handle
- Optional E-lock available in the vertical position. Please specify V - Vertical and add \$304.00 list.
- Grommet available only in BLK - Black

PRODUCT CODE	FINISH LP	B	W	SIZE/INCHES				WEIGHT LBS	VOL FT <sup>3</sup>
				H(LP/B)	H(W)	W	D		
FTCRBFO2060	2784	3048	3156	19.94	20.5	60	20	202	20
FTCRBFO2066	2868	3155	3274	19.94	20.5	66	20	220	22
FTCRBFO2072	3018	3328	3457	19.94	20.5	72	20	254	24
FTCRBFO2460	2894	3168	3282	19.94	20.5	60	24	202	20
FTCRBFO2466	2983	3282	3406	19.94	20.5	66	24	220	22
FTCRBFO2472	3138	3462	3595	19.94	20.5	72	24	254	24

**FTCROBF • Credenza, Open / Box/File**

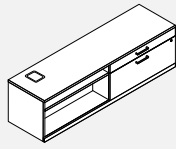

**NEW!**

- Credenza storage with grommet to accommodate a FreeFit C leg base.
- Recommended for use with the standard range bases only.
- One lock included
- One adjustable Shelf
- Select any standard Licence2 handle
- Optional E-lock available in the vertical position. Please specify V - Vertical and add \$304.00 list.
- Grommet available only in BLK - Black

PRODUCT CODE	FINISH LP	B	W	SIZE/INCHES				WEIGHT LBS	VOL FT <sup>3</sup>
				H(LP/B)	H(W)	W	D		
FTCROBF2060	2784	3048	3156	19.94	20.5	60	20	202	20
FTCROBF2066	2868	3155	3274	19.94	20.5	66	20	220	22
FTCROBF2072	3018	3328	3457	19.94	20.5	72	20	254	24
FTCROBF2460	2894	3168	3282	19.94	20.5	60	24	202	20
FTCROBF2466	2983	3282	3406	19.94	20.5	66	24	220	22
FTCROBF2472	3138	3462	3595	19.94	20.5	72	24	254	24

**FTCRBFO-T • Credenza, Box/File / Open**

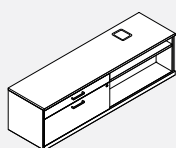

**NEW!**

- Credenza storage with grommet to accommodate a FreeFit T-leg base.
- Recommended for use with the standard range bases only.
- One lock included
- One adjustable Shelf
- Select any standard Licence2 handle
- Optional E-lock available in the vertical position. Please specify V - Vertical and add \$304.00 list.
- Grommet available only in BLK - Black

PRODUCT CODE	FINISH LP	B	W	SIZE/INCHES				WEIGHT LBS	VOL FT <sup>3</sup>
				H(LP/B)	H(W)	W	D		
FTCRBFO2060T	2784	3048	3156	19.94	20.5	60	20	202	20
FTCRBFO2066T	2868	3155	3274	19.94	20.5	66	20	220	22
FTCRBFO2072T	3018	3328	3457	19.94	20.5	72	20	254	24
FTCRBFO2460T	2894	3168	3282	19.94	20.5	60	24	202	20
FTCRBFO2466T	2983	3282	3406	19.94	20.5	66	24	220	22
FTCRBFO2472T	3138	3462	3595	19.94	20.5	72	24	254	24

**FTCROBF-T • Credenza, Open / Box/File**

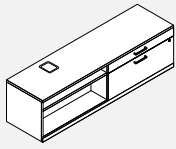

**NEW!**

- Credenza storage with grommet to accommodate a FreeFit T-leg base.
- Recommended for use with the standard range bases only.
- One lock included
- One adjustable Shelf
- Select any standard Licence2 handle
- Optional E-lock available in the vertical position. Please specify V - Vertical and add \$304.00 list.
- Grommet available only in BLK - Black

PRODUCT CODE	FINISH LP	B	W	SIZE/INCHES				WEIGHT LBS	VOL FT <sup>3</sup>
				H(LP/B)	H(W)	W	D		
FTCROBF2060T	2784	3048	3156	19.94	20.5	60	20	202	20
FTCROBF2066T	2868	3155	3274	19.94	20.5	66	20	220	22
FTCROBF2072T	3018	3328	3457	19.94	20.5	72	20	254	24
FTCROBF2460T	2894	3168	3282	19.94	20.5	60	24	202	20
FTCROBF2466T	2983	3282	3406	19.94	20.5	66	24	220	22
FTCROBF2472T	3138	3462	3595	19.94	20.5	72	24	254	24

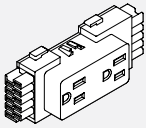
**BRT8D • Duplex Receptacles**

- Snaps into Power Distribution Housing.
- Up to 6 duplex receptacles per circuit.
- xxxD1 = Circuit #1 (utility circuit)
- xxxD2 = Circuit #2 (utility circuit)
- xxxD3 = Circuit #3 (utility circuit)
- xxxDA - Circuit #A (dedicated circuit)
- XW identifies white color plastic, all others in standard black.

PRODUCT CODE	PRICE	SIZE/INCHES			WEIGHT VOL	
		H	W	D	LBS	FT <sup>3</sup>
BRT8D1	42	2	4.625	1.25	0.10	0.01
BRT8D2	42	2	4.625	1.25	0.10	0.01
BRT8D3	42	2	4.625	1.25	0.10	0.01
BRT8DA	42	2	4.625	1.25	0.10	0.01
BRT8DXW1	56	2	4.625	1.25	0.10	0.01
BRT8DXW2	56	2	4.625	1.25	0.10	0.01
BRT8DXW3	56	2	4.625	1.25	0.10	0.01
BRT8DXWA	56	2	4.625	1.25	0.10	0.01

**GAADG • Access Door Module**

- Soft close door is set back from edge to allow for cable pass thru.
- Available in all standard panel frame finishes.
- GAADGDH includes device holder for most mobile phones or tablets. Holder is only available in white.
- FreeFit can only accommodate one grommet per worksurface.

PRODUCT CODE	PRICE	SIZE/INCHES			WEIGHT VOL	
		H	D	W	LBS	FT <sup>3</sup>
GAADG	76	1.08	5.54	10.09	2	0.04
GAADGDH	77	1.08	5.54	10.09	2	0.04

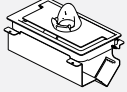
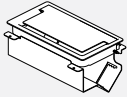
**GAADCT • Access Door Module With Cable Tray**

- Soft close door is set back from edge to allow for cable pass thru when closed.
- Cable tray comes one standard telecom knock out and a platform to mount a powerbar.
- Sides are open for easy access.
- Available in all standard panel frame finishes.
- GAADCTDH includes device holder for most mobile phones or tablets. Holder is only available in white.
- FreeFit can only accommodate one grommet per worksurface.

PRODUCT CODE	PRICE	SIZE/INCHES			WEIGHT VOL	
		H	D	W	LBS	FT <sup>3</sup>
GAADCT	115	5.07	5.54	10.09	4	0.19
GAADCTDH	122	5.07	5.54	10.09	4	0.19

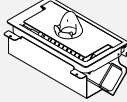
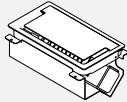
**GAADCTPD • Access Door Module With Cable Tray and Power Bar**

- Powerbar with 3 simplex and 2 USB, CSA Certified.
- Soft close door is set back from edge to allow for cable pass thru when closed.
- Cable tray comes one standard telecom knock out and a platform to mount a powerbar.
- Sides are open for easy access.
- Available in all standard panel frame finishes.
- GAADCTPDDH includes device holder for most mobile phones or tablets. Holder is only available in white.
- FreeFit can only accommodate one grommet per worksurface.

PRODUCT CODE	PRICE	SIZE/INCHES			WEIGHT VOL	
		H	D	W	LBS	FT <sup>3</sup>
GAADCTPD	249	6.96	5.54	10.09	4	0.20
GAADCTPDDH	254	6.96	5.54	10.09	4	0.20

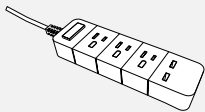
**BWAEGC00158GC • Power Bar With USB**

- Power Bar with 3 receptacles + 2 USB and power switch.
- Standard with 6' cord.
- Rating 15A, 125V, AC 60Hz, 1875W.
- USB output 5V, 2.6A (max.)
- White case, white cord.

PRODUCT CODE	PRICE	SIZE/INCHES			WEIGHT VOL	
		H	W	D	LBS	FT <sup>3</sup>
BWAEGC00158GC	86	1.3	2.3	1	1	0.02

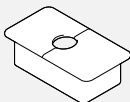
**BG5 • Rectangular Grommet**

- Option (BLK) Black Plastic (GRY) Grey Plastic (WHT) White Plastic

PRODUCT CODE	PRICE	SIZE/INCHES			WEIGHT VOL	
		H	W	D	LBS	FT <sup>3</sup>
BG5	58		3.5	2		

**MSPDM • 1 Duplex, 1 Data**

- Includes one duplex and two data jacks (both RJ45, Cat6).
- Black plastic

PRODUCT CODE	PRICE	SIZE/INCHES			WEIGHT VOL	
		H	W	D	LBS	FT <sup>3</sup>
MSPDM	355	2.75	6.5	3.5	2	0.1

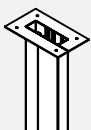
**BWAECF • Ceiling Feed Post**

- Ceiling pole brings ceiling feed conduit and data cables from the ceiling down to Power troughs height. Accommodates 9' - 3" ceiling heights.
- A two part construction allows power/data conduit lay-in.
- Includes mounting hardware and ceiling bezel.
- Painted finish.

PRODUCT CODE	PRICE	SIZE/INCHES			WEIGHT VOL	
		H	D	W	LBS	FT <sup>3</sup>
BWAECF	387	99.32	2.5	4.74	13	0.48



**BWAECFH • Ceiling Feed Harness**



- Ceiling feed provides a single power entry from ceiling, through Ceiling pole into Power Trough, into Power Distribution Housing.
- An 8-wire (4-circuit) metal conduit harness with included metal junction box for hard wiring to the building power supply above ceiling tile.
- Must be hard wired to the building power supply by a licensed electrician.
- Ceiling Pole not included.

PRODUCT CODE	PRICE	SIZE/INCHES			WEIGHT		VOL FT <sup>3</sup>
		H	D	W	LBS		
BWAECFH120	493	120	6	6.00	5.00	2	
BWAECFH144	549	144	6	6.00	6.00	3	

**FTAEC • Table to Table Connector**

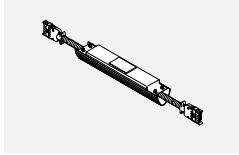

- Connects FreeFit back2back legs and trough provide power data/communication pass thru
- Connector kit consist of formed steel housing, mounting brackets,
- Housing to housing harness and one charcoal grey extruded Data/Communication cable manager
- For table to table up to 72" w (with no storage in between tables), use FTAETTC12.
- For table to table 78" w (when no storage in between), use FTAETTC18.
- For table to table 84" w (when no storage in between), use FTAETTC24.
- For table to table up to 72" w with a Pantry Storage is in between, use FTAETTC24.

PRODUCT CODE	PRICE	SIZE/INCHES			WEIGHT		VOL FT <sup>3</sup>
		H	D	W	LBS		
FTAEC12	372	3	16	2.3	6.00	0.12	
FTAEC18	398	3	22	2.3	8.00	0.15	
FTAEC24	423	3	28	2.3	9.00	0.18	
FTAEC30	446	3	34	2.3	10.60	0.22	
FTAEC36	468	3	40	2.3	12.00	0.24	
FTAEC42	501	3	46	2.3	11.60	0.28	
FTAEC48	536	3	52	2.3	14.00	0.30	

**FTABRC • Table to Boulevard Connector**

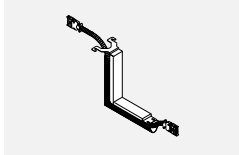

- Connects FreeFit back2back benching to a 29H table with below surface power trough.
- Please specify paint color on bracket. Wire manager is always charcoal.

PRODUCT CODE	PRICE	SIZE/INCHES			WEIGHT		VOL FT <sup>3</sup>
		H	D	W	LBS		
FTABRC	314	13	13	2.3	2.4	0.28	

**FTACCL • Lea Wire Manager**

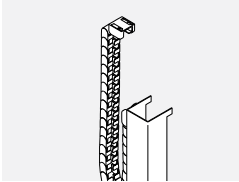

- Provides wire management from under FreeFit worksurface, down the leg and to the floor.
- Can only be used for FreeFit Regular and Media tables. Not for use on FreeFit Back-to-Back tables.
- Kit includes wire manager housing, magnets, screws and cable chain.
- Magnetically fastens to the FreeFit leg and cable chain is screwed to work surface.
- Please specify housing paint finish.

PRODUCT CODE	PRICE	SIZE/INCHES			WEIGHT		VOL FT <sup>3</sup>
		H	D	W	LBS		
FTACCL	557	16	3.2	2	0.06	0.06	

**FTAEFF • Floor Feed**

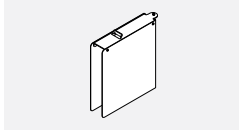

- Floor feed housing for FreeFit benching applications only
- Liquid tight whip 72"
- Must be hard wired to power source by a licenced technician
- Please choose paint color for housing.

PRODUCT CODE	PRICE	SIZE/INCHES			WEIGHT		VOL FT <sup>3</sup>
		H	D	W	LBS		
FTAEFF	797	10.8	8.75	2	7	0.23	

**FFTCB • Under-Worksurface Cable Basket**

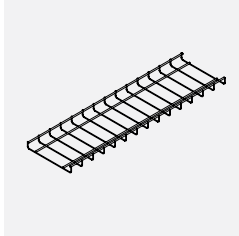

- Shallow 8" wide basket manages cable excess.
- It can be easily unclipped from steel brackets (included) to rearrange cable connections from below work surface.
- As a general rule- specify cable basket 30" shorter that the FreeFit work surface.
- Steel wire construction, black painted finish, black steel hanging brackets and fasteners.

PRODUCT CODE	PRICE	SIZE/INCHES			WEIGHT		VOL FT <sup>3</sup>
		H	W	D	LBS		
FFTCB36	109	1	8	8	0.36	0.03	
FFTCB48	118	1	16	8	0.73	0.07	
FFTCB54	125	1	22	8	1.01	0.10	
FFTCB60	133	1	28	8	1.20	0.13	
FFTCB66	155	1	34	8	1.56	0.15	
FFTCB72	161	1	40	8	1.80	0.18	
FFTCB78	169	1	46	8	2.16	0.21	
FFTCB84	179	1	52	8	2.39	0.24	

**BRACS • Cable Snake**



- Flexible cable management trough.
- Two pathways within the snake, one for data/communication and one for routing power cables.
- Clear (CLR) available only.

PRODUCT CODE	PRICE	SIZE/INCHES			WEIGHT		VOL FT <sup>3</sup>
		H	W	D	LBS		
BRACS	169	30	8	2	3	0.19	
BRACSH	287	49	8	2	5	0.27	

**FTBATT • Battery and Charger**

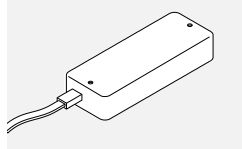

- Battery pack with charging cable mounts to the underside of the worksurface
- Features LED bars indicating capacity level and audio alarm when it needs to be charged.
- On a full charge the table can cycle from 35 to 45 stroke lengths based upon the range of column selected and load on the table.

PRODUCT CODE	PRICE	SIZE/INCHES			WEIGHT		VOL FT <sup>3</sup>
		H	D	W	LBS		
FTBATT	1235	1.5	8	3	1.54	0.02	

**FTACDS • Anti-Collision Desk Sensor USB Plug**

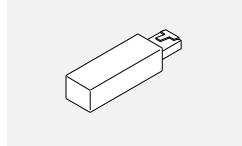

- Provides enhanced anti-collision detection.
- Plugs directly into leg column.
- Only one USB plug required for table assembly.
- This is a replacement part. The sensor ships stand with every table.

PRODUCT CODE	PRICE	SIZE/INCHES			WEIGHT		VOL FT <sup>3</sup>
		H	D	W	LBS		
FTACDS	103	0.5	2.36	0.6	0.01	0.01	

**FTDPG1C • Display + Bluetooth + Reminder Controller**

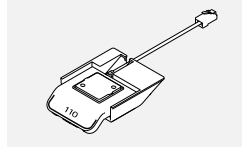

- Up/down drive with 4 memory positions.
- LED Light strip reminder, table height display.
- Bluetooth enabled connects to Desk Control App.

PRODUCT CODE	PRICE	SIZE/INCHES			WEIGHT		VOL FT <sup>3</sup>
		H	D	W	LBS		
FTDPG1C	239	1	3	4.3	0.4	0.01	

**FTDPG1M • Memory + Bluetooth + Diode Reminder Controller**

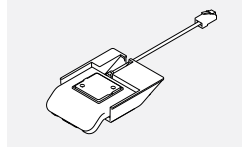

- Up/down drive with 2 memory positions.
- Bluetooth enabled connects to Desk Control App.
- This is a replacement part. Every base comes standard with a controller.

PRODUCT CODE	PRICE	SIZE/INCHES			WEIGHT		VOL FT <sup>3</sup>
		H	D	W	LBS		
FTDPG1M	97	1	3	4.3	0.4	0.01	

**FTCD2USB • Desk2Device USB Charger**

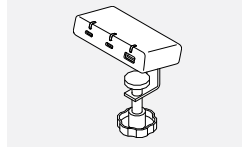

- Charge virtually any USB device directly from your FreeFit desk. Reduce cable clutter and get better power access.
- The charger is powered directly by the control box of a FreeFit table, no additional power outlet is required.
- Features one USB Type-A port (output 7.5w), two USB Type-C ports (output 50w if one port is used, 25w if both are used).
- Housing is white in color and the mounts are in black.
- Can be mounted on top of the table surface or underneath the surface (horizontal or slightly tilted).
- Includes two different mounts and a rubber (silicone) pad to secure placement on a smooth desk surface.
- Low standby power consumption of only 0.1w.
- LED diodes indicate either charging or that an active device is connected.
- PVC-Free (TM).

PRODUCT CODE	PRICE	SIZE/INCHES			WEIGHT		VOL FT <sup>3</sup>
		H	D	W	LBS		
FTCD2USB	575	0.85	3.77	1.96	0.187	0.004	

## FreeFit • Single Table; 21'-High Dividers

- FreeFit table mounted dividers for single table or single table row; recessed 6.5" at both ends (for example - 72" (70" actual) FreeFit table mounted divider measures 57").
- The center of all dividers is always mounted 2.250" from work surface's rear edge. Please note the gap between the divider and the work surface therefore varies, depending on the divider thickness (1.250" framed dividers, 0.750" frame-less LP and 0.250" frame-less glass).
- 48" (33" actual) - 66" (51" actual) dividers have 2 mounting brackets.
- 72" (57" actual) dividers have 3 mounting brackets.

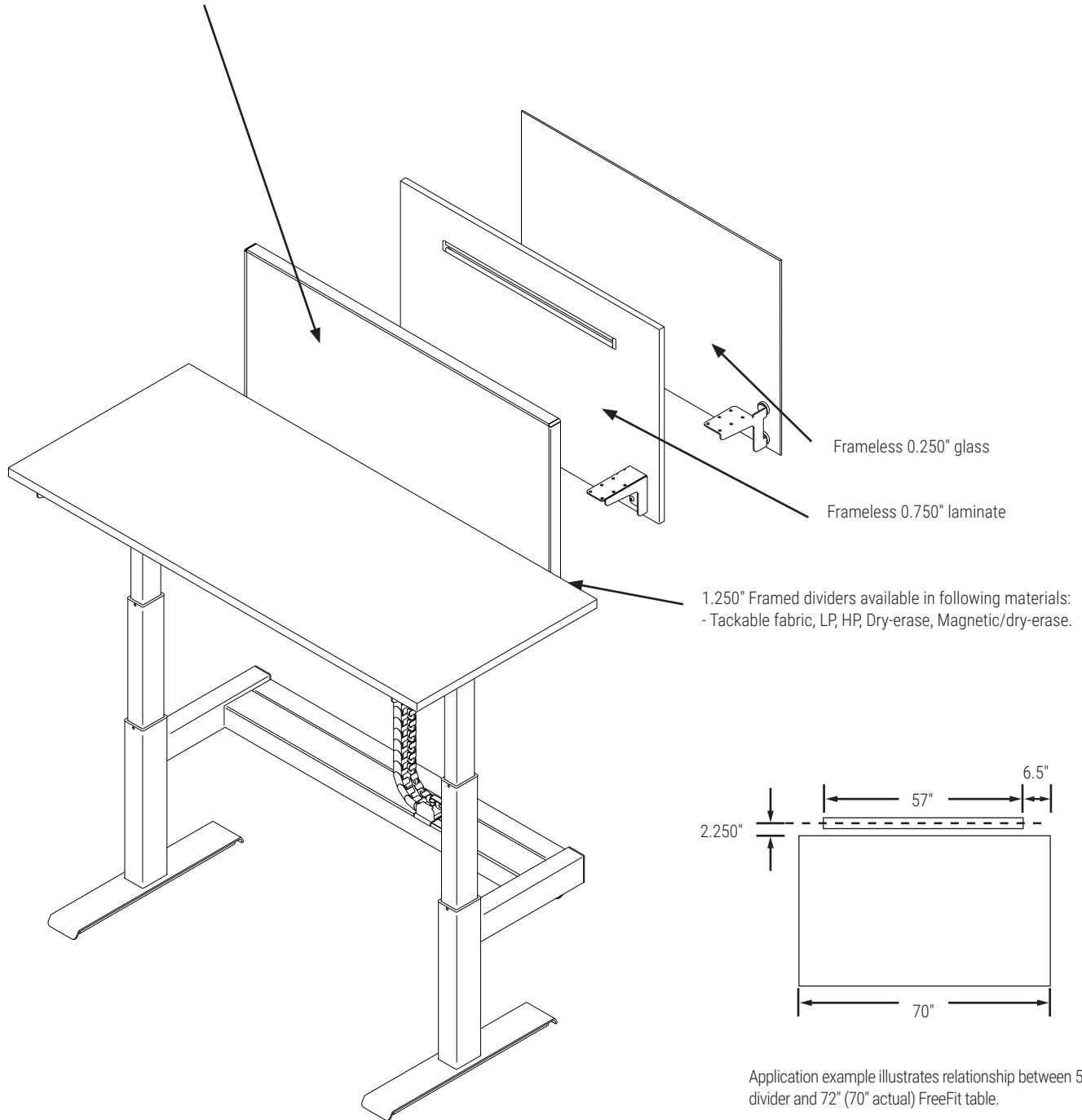

Example Order:  
 BWATMFD72  
 (actual dimension of 57") for  
 BWA2D3072A8  
 (actual dimension of 70").

**FreeFit • Back-2-Back Table; 37" High Dividers**

- FreeFit Back-2-Back stationary dividers; stationary, shared, secured to table structure; recessed 6.5" at both ends (for example - 72" (70" actual) FreeFit table mounted divider measures 57").
- The center of all dividers is always mounted 2.250" from work surface's rear edge. Please note the gap between the divider and the worksurface therefore varies, depending on the divider thickness (1.250" Framed dividers, 0.750" frame-less LP and 0.250" frame-less glass).
- 48" (33" actual) divider for 48" (46" actual) table
- 54" (39" actual) divider for 54" (52" actual) table
- 60" (45" actual) divider for 60" (58" actual) table
- 66" (51" actual) divider for 66" (64" actual) table
- 72" (57" actual) divider for 72" (70" actual) table

- Framed dividers (Tackable fabric, LP, HP, Dryerase, Magnetic/dry-erase).
- Frameless LP
- Frameless glass

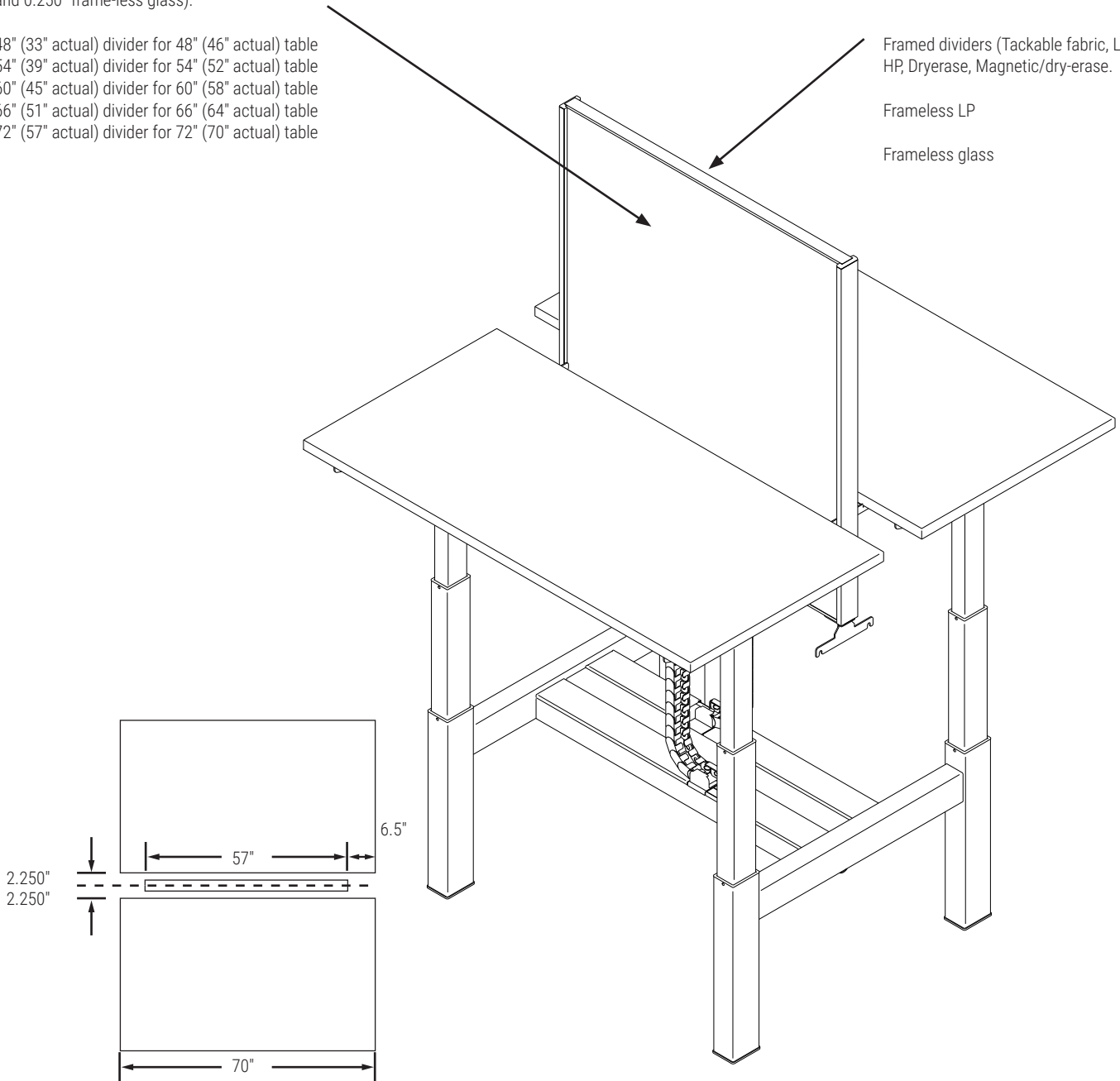

Application example illustrates relationship between 57" shared divider and 72" (70" actual) FreeFit Back-2-Back table.

Example Order:  
 BWASFD72  
 (actual dimension of 57") for  
 BWA2D6072A8  
 (actual dimension of 70").

**BWATMFD/BWATMLD • Table-Mounted Framed Dividers**

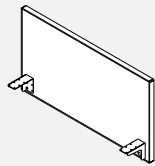

- Connects parallel on FreeFit single and back 2 back tables.
- Divider frame and connecting hardware is painted, please choose from standard metal paint finishes.
- Fabric divider is tackable.
- Divider infill can be specified in fabric, low pressure laminate (LP), high pressure laminate (HP), dry erase whiteboard (DE) or dry erase magnetic whiteboard (DM) user side only.
- Fastens to the underside of the worksurface
- 1.625" gap between worksurface and divider allows for cable pass thru
- Installed divider measures 15.7" from top of worksurface and 5.75" below the worksurface.
- 48" to 66" dividers include 2 support brackets. 72" divider includes 3 support brackets.
- When dry erase magnetic whiteboard (DM) is specified it is applied user side ONLY and dry erase whiteboard (DE) is applied on the opposite side

**TACKABLE FABRIC**

PRODUCT CODE	PRICE		SIZE/INCHES			WEIGHT		VOL FT <sup>3</sup>
	G1	G2	H	W	D	LBS		
BWATMFD48	409	453	21.5	33	1.25	16	1.23	
BWATMFD54	439	481	21.5	39	1.25	18	1.46	
BWATMFD60	476	528	21.5	45	1.25	20	1.68	
BWATMFD66	532	592	21.5	51	1.25	22	1.90	
BWATMFD72	587	647	21.5	57	1.25	26	2.13	

**LAMINATE**

PRODUCT CODE	PRICE				SIZE/INCHES			WEIGHT		VOL FT <sup>3</sup>
	LP	HP	DE	DM	H	W	D	LBS		
BWATMLD48	255	404	605	790	21.5	33	1.25	35	1.23	
BWATMLD54	290	481	726	964	21.5	39	1.25	39	1.46	
BWATMLD60	342	545	803	1061	21.5	45	1.25	44	1.68	
BWATMLD66	394	676	1358	1823	21.5	51	1.25	48	1.90	
BWATMLD72	429	711	1385	1848	21.5	57	1.25	52	2.13	

**BWASFD/BWASLD • Stationary Framed Dividers**

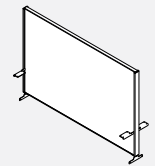

- Provides a stationary framed divider between back 2 back height-adjustable tables
- Divider frame and connecting hardware is painted, please choose from standard metal paint finishes.
- Fabric divider is tackable.
- Divider infill can be specified in fabric, low pressure laminate (LP), high pressure laminate (HP),
- Dry erase whiteboard (DE) or dry erase magnetic whiteboard (DM).
- Divider is anchored to the base and captured between two aluminum upright tracks. The uprights have sliding brackets that connect the worksurfaces to the divider providing continuous support as it travels up and down.
- 1.625" gap between worksurface and divider allows for cable pass thru
- Installed divider measures 54" from floor.

**TACKABLE FABRIC**

PRODUCT CODE	PRICE		SIZE/INCHES			WEIGHT		VOL FT <sup>3</sup>
	G1	G2	H	W	D	LBS		
BWASFD48	812	853	37.2	33	2	25	2.13	
BWASFD54	830	872	37.2	39	2	28	2.52	
BWASFD60	848	900	37.2	45	2	31	2.91	
BWASFD66	897	957	37.2	51	2	34	3.29	
BWASFD72	1162	1222	37.2	57	2	37	3.68	

**LAMINATE**

PRODUCT CODE	PRICE				SIZE/INCHES			WEIGHT		VOL FT <sup>3</sup>
	LP	HP	DE	DM	H	W	D	LBS		
BWASLD48	701	1086	1578	2998	37.2	33	2	58	2.13	
BWASLD54	756	1172	1678	3172	37.2	39	2	66	2.52	
BWASLD60	775	1190	1697	3191	37.2	45	2	73	2.91	
BWASLD66	815	1279	2829	5667	37.2	51	2	81	3.29	
BWASLD72	1061	1752	2998	5986	37.2	57	2	88	3.68	

**BWATMLLD • Table-Mounted Laminate Dividers**

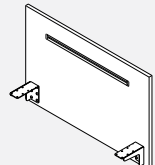

- Connects parallel on FreeFit single and back 2 back tables.
- Laminate divider with integrated accessory rail, installed one side only.
- Integrated anodized aluminum accessory rail, white cut out and rail trims; white powder coat brackets.
- 3/4" LP PVC edged boards, please specify laminate & 3mm PVC edge.
- Fastens to the underside of the worksurface.
- 1.88 gap between worksurface and divider allows for cable pass thru.
- Installed divider measures 15.7" from top of worksurface and 5.75" below the worksurface.
- 48" to 66" dividers include 2 support brackets. 72" divider includes 3 support brackets.

**LAMINATE**

PRODUCT CODE	PRICE		SIZE/INCHES			WEIGHT		VOL FT <sup>3</sup>
	H	W	D	LBS				
BWATMLLD48	307	21.5	33	0.75	16	1.23		
BWATMLLD54	325	21.5	39	0.75	19	1.46		
BWATMLLD60	344	21.5	45	0.75	21	1.68		
BWATMLLD66	510	21.5	51	0.75	24	1.90		
BWATMLLD72	526	21.5	57	0.75	27	2.13		

**BWASLLD • Stationary Laminate Dividers**

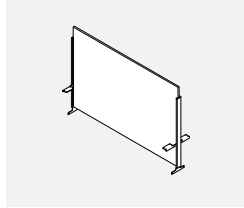

- Provides a stationary laminate divider between back 2 back height-adjustable tables
- Divider uprights and connecting hardware is painted, please choose from standard metal paint finishes.
- Please specify laminate (LP) finish.
- Divider is anchored to the base and captured between two aluminum upright tracks. The uprights have sliding brackets that connect the worksurfaces to the divider providing continuous support as it travels up and down.
- 1.88" gap between worksurface and divider allows for cable pass thru.
- Installed divider measures 54" from floor.

LAMINATE PRODUCT CODE	PRICE	SIZE/INCHES			WEIGHT LBS	VOL FT <sup>3</sup>
		H	W	D		
BWASLLD48	622	37.2	33	2	28	2.13
BWASLLD54	640	37.2	39	2	33	2.52
BWASLLD60	659	37.2	45	2	37	2.91
BWASLLD66	999	37.2	51	2	41	3.29
BWASLLD72	1018	37.2	57	2	46	3.68

**BWATMGD • Table-Mounted Glass Dividers**

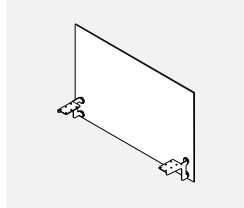

- Frameless glass divider connects parallel on single and back 2 back tables.
- Tempered glass, acid etched on one side (similar to frosted), satin chrome disc fasteners and powder coated steel support brackets.
- Fastens to the underside of the worksurface.
- 2.13 gap between worksurface and divider allows for cable pass thru.
- Installed divider measures 15.7" from top of worksurface and 4.75" below the worksurface.
- 54" to 66" dividers include 2 support brackets. 72" divider includes 3 support brackets.
- 1/2" radius on all four corners.

GLASS PRODUCT CODE	PRICE	SIZE/INCHES			WEIGHT LBS	VOL FT <sup>3</sup>
		H	W	D		
BWATMGD48	657	21.5	33	0.25	16	1.23
BWATMGD54	708	21.5	39	0.25	19	1.46
BWATMGD60	760	21.5	45	0.25	22	1.68
BWATMGD66	805	21.5	51	0.25	24	1.90
BWATMGD72	855	21.5	57	0.25	28	2.13

**BWASGD • Stationary Glass Dividers**

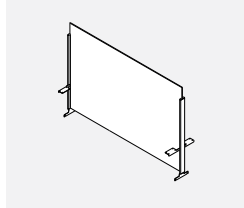

- Provides a stationary glass divider between back 2 back height-adjustable tables.
- Tempered glass, acid etched on one side (similar to frosted), satin chrome disc fasteners and white powdercoated steel support brackets.
- Divider is anchored to the base and captured between two aluminum upright tracks. The uprights have sliding brackets that connect the worksurfaces to the divider providing continuous support as it travels up and down.
- 2.13 gap between worksurface and divider allows for cable pass thru.
- 1/2" radius on top two corners.

GLASS PRODUCT CODE	PRICE	SIZE/INCHES			WEIGHT LBS	VOL FT <sup>3</sup>
		H	W	D		
BWASGD48	583	37.2	33	2	30	2.13
BWASGD54	664	37.2	39	2	34	2.52
BWASGD60	753	37.2	45	2	39	2.91
BWASGD66	833	37.2	51	2	43	3.29
BWASGD72	915	37.2	57	2	48	3.68

**BWAFWR • Felt Wrap-Around Divider for FreeFit Table**

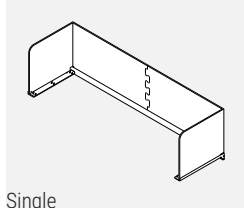

Single

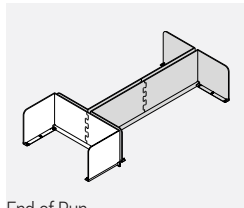

End-of-Run

- Wraps around FreeFit table to provide privacy.
- 9mm Felt material is tackable and comes in 12 different colors. Please specify color.
- Installed divider measures 15.7" high from top of the worksurface.
- Please choose standard metal finish for extrusion and brackets.
- Upcharge of \$147 for anodized extrusion option.
- Divider extends by 1.5" at the back.
- For sizes 2346, 2351 and 2352, the felt will be manufactured in one piece, while all others will be manufactured in two pieces as shown.
- Note: Cannot use ceiling feed option with this divider.

PRODUCT CODE	PRICE	SIZE/INCHES			WEIGHT LBS	VOL FT <sup>3</sup>
		H	W	D		
BWAFWR2346	528	18.24	46.84	18.46	26.58	1.07
BWAFWR2352	558	18.24	52.84	18.46	28.40	1.21
BWAFWR2358	589	18.24	58.84	18.46	30.22	1.34
BWAFWR2364	779	18.24	64.84	18.46	32.02	0.74
BWAFWR2370	832	18.24	70.84	18.46	33.84	0.81
BWAFWR2946	599	18.24	46.84	24.46	30.74	1.07
BWAFWR2952	789	18.24	52.84	24.46	32.55	0.60
BWAFWR2958	841	18.24	58.84	24.46	34.37	0.67
BWAFWR2964	894	18.24	64.84	24.46	36.19	0.74
BWAFWR2970	945	18.24	70.84	24.46	38.00	0.81
<b>End-of-Run</b>						
BWAFWR2351	535	18.24	51.34	27.94	27.94	1.05
BWAFWR2951	788	18.24	51.34	32.09	32.09	0.62
BWAFWR2363	778	18.24	63.34	31.57	31.57	1.50
BWAFWR2963	891	18.24	63.34	35.73	35.73	0.87

**BWAFPNxx • Parallel Felt Divider**

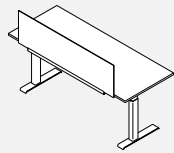

- Felt divider connects parallel on a single or Back-to-Back FreeFit table.
- 9 mm felt material is tackable and comes in a wide range of colors.
- Installed, the divider measures 15.7" high from the top of the worksurface.
- Kit includes felt divider, support extrusion and left and right brackets.
- Please choose the finish of the felt and the metal finish for the extrusion and brackets.

PRODUCT CODE	PRICE LIST	SIZE/INCHES			WEIGHT LBS	VOL FT <sup>3</sup>
		H	W	D		
BWAFPN36	198	18.24	21	5.86	2.21	1.30
BWAFPN42	222	18.24	27	5.86	2.77	1.67
BWAFPN48	280	18.24	33	5.86	2.82	2.04
BWAFPN54	313	18.24	39	5.86	3.29	2.41
BWAFPN60	356	18.24	45	5.86	3.75	2.78
BWAFPN66	501	18.24	51	5.86	4.22	3.15
BWAFPN72	534	18.24	57	5.86	4.69	3.53

**BWAFMPSNxx • Modesty Felt Divider**

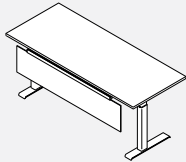

- Felt modesty panel secures to the rear bottom of a regular FreeFit table and provides privacy below the worksurface.
- 9 mm felt material is tackable and comes in a wide range of colors.
- Installed, the divider measures 15" high below the top of the worksurface.
- Kit includes felt modesty, support extrusion and left and right brackets.
- Please choose the finish of the felt and the metal finish for the extrusion and brackets.

PRODUCT CODE	PRICE LIST	SIZE/INCHES			WEIGHT LBS	VOL FT <sup>3</sup>
		H	W	D		
BWAFMPSN36	186	13.94	21	4.17	1.84	0.71
BWAFMPSN42	203	13.94	27	4.17	2.32	0.91
BWAFMPSN48	261	13.94	33	4.17	2.44	1.11
BWAFMPSN54	293	13.94	39	4.17	2.86	1.31
BWAFMPSN60	331	13.94	45	4.17	3.27	1.51
BWAFMPSN66	468	13.94	51	4.17	3.68	1.72
BWAFMPSN72	498	13.94	57	4.17	4.09	1.92

**BWAFPDNxx • Parallel Above and Below Felt Divider**

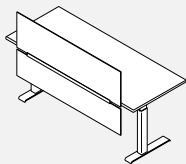

- Felt divider and modesty panel kit secures to the rear bottom of a regular FreeFit table and provides privacy above and below the worksurface.
- 9 mm felt material is tackable and comes in a wide range of colors.
- Installed, the divider measures 15.7 high from the top of the worksurface and 15" high below the top of the worksurface.
- Kit includes two felt dividers, support extrusion and left and right brackets.
- Please choose the finish of the felt and the metal finish for the extrusion and brackets.

PRODUCT CODE	PRICE LIST	SIZE/INCHES			WEIGHT LBS	VOL FT <sup>3</sup>
		H	W	D		
BWAFPDN36	293	30.68	21	5.86	2.79	2.18
BWAFPDN42	320	30.68	27	5.86	3.56	2.81
BWAFPDN48	420	30.68	33	5.86	3.82	3.43
BWAFPDN54	466	30.68	39	5.86	4.5	4.06
BWAFPDN60	543	30.68	45	5.86	5.17	4.68
BWAFPDN66	832	30.68	51	5.86	5.85	5.31
BWAFPDN72	884	30.68	57	5.86	6.53	5.93

**BWAFc • Corner Wrap Felt Divider**

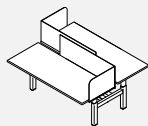
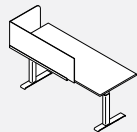

- Felt Corner Wrap secures to the side and rear bottom of a FreeFit table, wraps around one side and provides limited privacy.
- 9 mm felt material is tackable and comes in a wide range of colors.
- Installed, the divider measures 15.7 high from the top of the worksurface..
- Kit includes felt dividers, support extrusion and large and small handed brackets.
- Please choose the finish of the felt and the metal finish for the extrusion and brackets.

PRODUCT CODE	PRICE LIST	SIZE/INCHES			WEIGHT LBS	VOL FT <sup>3</sup>
		H	W	D		
BWAFc2432L	381	18.24	32.46	18.52	4.99	6.35
BWAFc2432R	381	18.24	32.46	18.52	4.99	6.35
BWAFc2438L	435	18.24	38.46	18.52	5.46	7.52
BWAFc2438R	435	18.24	38.46	18.52	5.46	7.52
BWAFc2448L	468	18.24	47.46	18.52	6.16	9.28
BWAFc2448R	468	18.24	47.46	18.52	6.16	9.28
BWAFc3032L	431	18.24	32.46	24.52	5.72	8.40
BWAFc3032R	431	18.24	32.46	24.52	5.72	8.40
BWAFc3038L	462	18.24	38.46	24.52	6.19	9.95
BWAFc3038R	462	18.24	38.46	24.52	6.19	9.95
BWAFc3048L	496	18.24	47.46	24.52	6.89	12.28
BWAFc3048R	496	18.24	47.46	24.52	6.89	12.28

**FFTDPxxxxH24 • Height-Adjustable Table Polycarbonate Divider Screen Kit, 24" High**

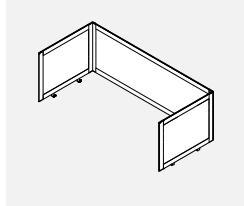

- Provides privacy in an open plan environment.
- Lightweight and easy to clean table mounted partitions.
- Consists of a powder coated aluminum frame, translucent fluted polycarbonate and all hardware to connect. Brackets are painted steel.
- Side dividers extend 6.237" from the front edge of each surface.
- Back divider extends over the back edge of the worksurface by 1 1/2" allowing for the passage of cables to the trough.
- FFTDP24xxH24 are for 23" deep surfaces and FFTDP30xxH24 are for 29" deep surfaces.
- Width and depth are nominal sizes representing the sizes of the FreeFit Table. Allow for 1/4" overhang at the sides, 1 1/2" at the back and 6.237" at the front.
- Please choose any standard paint finish from Teknion for frame and hardware. End trim cap is available only in CHR - charcoal.

PRODUCT CODE	PRICE	SIZE/INCHES			WEIGHT LBS	VOL FT <sup>3</sup>
		H	W	D		
FFTDP2436H24	897	24.63	34	31.75	26.55	3.94
FFTDP2442H24	921	24.63	40	31.75	28.10	4.59
FFTDP2448H24	945	24.63	46	31.75	29.65	5.25
FFTDP2454H24	968	24.63	42	31.75	31.20	5.91
FFTDP2460H24	993	24.63	58	31.75	32.75	6.56
FFTDP2466H24	1019	24.63	60	31.75	34.30	7.22
FFTDP2472H24	1041	24.63	70	31.75	35.85	7.88
FFTDP2478H24	1064	24.63	76	31.75	37.40	8.53
FFTDP2484H24	1112	24.63	82	31.75	38.95	9.19
FFTDP3036H24	928	24.63	34	37.75	40.50	4.72
FFTDP3042H24	952	24.63	40	37.75	42.05	5.51
FFTDP3048H24	976	24.63	46	37.75	43.60	6.29
FFTDP3054H24	1000	24.63	42	37.75	45.15	7.08
FFTDP3060H24	1024	24.63	58	37.75	46.70	7.87
FFTDP3066H24	1048	24.63	60	37.75	48.25	8.65
FFTDP3072H24	1072	24.63	70	37.75	49.80	9.44
FFTDP3078H24	1096	24.63	76	37.75	51.35	10.22
FFTDP3084H24	1144	24.63	82	37.75	52.90	11.01

**FFTDPxxxxH30 • Height-Adjustable Table Polycarbonate Divider Screen Kit, 30" High**

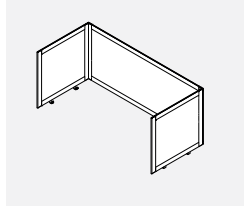

- Provides privacy in an open plan environment.
- Lightweight and easy to clean table mounted partitions.
- Consists of a powder coated aluminum frame, translucent fluted polycarbonate and all hardware to connect. Brackets are painted steel.
- Side dividers extend 6.237" from the front edge of each surface.
- Back divider extends over the back edge of the worksurface by 1 1/2" allowing for the passage of cables to the trough.
- FFTDP24xxH24 are for 23" deep surfaces and FFTDP30xxH24 are for 29" deep surfaces.
- Width and depth are nominal sizes representing the sizes of the FreeFit Table. Allow for 1/4" overhang at the sides, 1 1/2" at the back and 6.237" at the front.
- Please choose any standard paint finish from Teknion for frame and hardware. End trim cap is available only in CHR - charcoal.

PRODUCT CODE	PRICE	SIZE/INCHES			WEIGHT LBS	VOL FT <sup>3</sup>
		H	W	D		
FFTDP2436H30	891	30.63	34	31.75	26.55	3.94
FFTDP2442H30	913	30.63	40	31.75	28.10	4.59
FFTDP2448H30	935	30.63	46	31.75	29.65	5.25
FFTDP2454H30	957	30.63	42	31.75	31.20	5.91
FFTDP2460H30	979	30.63	58	31.75	32.75	6.56
FFTDP2466H30	1002	30.63	60	31.75	34.30	7.22
FFTDP2472H30	1024	30.63	70	31.75	35.85	7.88
FFTDP2478H30	1046	30.63	76	31.75	37.40	8.53
FFTDP2484H30	1100	30.63	82	31.75	38.95	9.19
FFTDP3036H30	934	30.63	34	37.75	40.50	4.72
FFTDP3042H30	956	30.63	40	37.75	42.05	5.51
FFTDP3048H30	978	30.63	46	37.75	43.60	6.29
FFTDP3054H30	1000	30.63	42	37.75	45.15	7.08
FFTDP3060H30	1024	30.63	58	37.75	46.70	7.87
FFTDP3066H30	1046	30.63	60	37.75	48.25	8.65
FFTDP3072H30	1068	30.63	70	37.75	49.80	9.44
FFTDP3078H30	1090	30.63	76	37.75	51.35	10.22
FFTDP3084H30	1142	30.63	82	37.75	52.90	11.01

**FFTDGxxxxH24 • Height-Adjustable Table Glass Divider Screen Kit, 24" High**

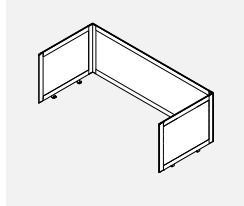

- Provides privacy in an open plan environment.
- Easy to clean table mounted partitions.
- Consists of a powder coated aluminum frame, 4mm clear (CLR) glass and all hardware to connect. Brackets are painted steel.
- Side dividers extend 6.237" from the front edge of each surface.
- Back divider extends over the back edge of the worksurface by 1 1/2" allowing for the passage of cables to the trough.
- FFTDG24xxH24 are for 23" deep surfaces and FFTDG30xxH24 are for 29" deep surfaces.
- Width and depth are nominal sizes representing the sizes of the FreeFit Table. Allow for 1/4" overhang at the sides, 1 1/2" at the back and 6.237" at the front.
- Please choose any standard paint finish from Teknion for frame and hardware. End trim cap is available only in CHR - charcoal.
- Upcharge for frosted (FRST) glass is 20%.

PRODUCT CODE	PRICE	SIZE/INCHES			WEIGHT LBS	VOL FT <sup>3</sup>
		H	W	D		
FFTDG2436H24	1380	24.60	34	31.50	26.55	3.94
FFTDG2442H24	1425	24.60	40	31.50	28.10	4.59
FFTDG2448H24	1470	24.60	46	31.50	29.65	5.25
FFTDG2454H24	1515	24.60	42	31.50	31.20	5.91
FFTDG2460H24	1560	24.60	58	31.50	32.75	6.56
FFTDG2466H24	1605	24.60	60	31.50	34.30	7.22
FFTDG2472H24	1651	24.60	70	31.50	35.85	7.88
FFTDG2478H24	1696	24.60	76	31.50	37.40	8.53
FFTDG2484H24	1742	24.60	82	31.50	38.95	9.19
FFTDG3036H24	1466	24.60	34	37.75	40.50	4.72
FFTDG3042H24	1511	24.60	40	37.75	42.05	5.51
FFTDG3048H24	1556	24.60	46	37.75	43.60	6.29
FFTDG3054H24	1601	24.60	42	37.75	45.15	7.08
FFTDG3060H24	1647	24.60	58	37.75	46.70	7.87
FFTDG3066H24	1691	24.60	60	37.75	48.25	8.65
FFTDG3072H24	1737	24.60	70	37.75	49.80	9.44
FFTDG3078H24	1782	24.60	76	37.75	51.35	10.22
FFTDG3084H24	1828	24.60	82	37.75	52.90	11.01



**FFTDGxxxxH30 • Height-Adjustable Table Glass Divider Screen Kit, 30" High**

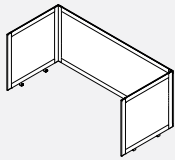

- Provides privacy in an open plan environment.
- Easy to clean table mounted partitions.
- Consists of a powder coated aluminum frame, 4mm clear (CLR) glass and all hardware to connect. Brackets are painted steel.
- Side dividers extend 6.237" from the front edge of each surface.
- Back divider extends over the back edge of the worksurface by 1 1/2" allowing for the passage of cables to the trough.
- FTDG24xxH30 are for 23" deep surfaces and FTDG30xxH30 are for 29" deep surfaces.
- Width and depth are nominal sizes representing the sizes of the FreeFit Table. Allow for 1/4" overhang at the sides, 1 1/2" at the back and 6.237" at the front.
- Please choose any standard paint finish from Teknion for frame and hardware. End trim cap is available only in CHR - charcoal.
- Upcharge for frosted (FRST) glass is 20%.

PRODUCT CODE	PRICE	SIZE/INCHES			WEIGHT LBS	VOL FT <sup>3</sup>
		H	W	D		
FFTDG2436H30	1445	30.60	34	31.50	28.85	3.94
FFTDG2442H30	1491	30.60	40	31.50	30.40	4.59
FFTDG2448H30	1538	30.60	46	31.50	31.95	5.25
FFTDG2454H30	1585	30.60	42	31.50	33.50	5.91
FFTDG2460H30	1632	30.60	58	31.50	35.05	6.56
FFTDG2466H30	1679	30.60	60	31.50	36.60	7.22
FFTDG2472H30	1706	30.60	70	31.50	38.15	7.88
FFTDG2478H30	1772	30.60	76	31.50	39.70	8.53
FFTDG2484H30	1819	30.60	82	31.50	41.25	9.19
FFTDG3036H30	1537	30.60	34	37.75	42.80	4.72
FFTDG3042H30	1583	30.60	40	37.75	44.35	5.51
FFTDG3048H30	1630	30.60	46	37.75	45.90	6.29
FFTDG3054H30	1678	30.60	42	37.75	47.45	7.08
FFTDG3060H30	1725	30.60	58	37.75	49.00	7.87
FFTDG3066H30	1771	30.60	60	37.75	50.55	8.65
FFTDG3072H30	1798	30.60	70	37.75	52.10	9.44
FFTDG3078H30	1864	30.60	76	37.75	53.65	10.22
FFTDG3084H30	1911	30.60	82	37.75	55.20	11.01

**FFTDFxxxxH24 • Height-Adjustable Table Felt Divider Screen Kit, 24" High**

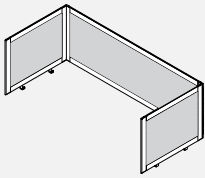

- Provides privacy in an open plan environment.
- Consists of a powder coated aluminum frame, 9mm felt and all hardware to connect. Brackets are painted steel.
- Side dividers extend 6.237" from the front edge of each surface.
- Back divider extends over the back edge of the worksurface by 1 1/2" allowing for the passage of cables to the trough.
- FFTDF24xxH24 are for 23" deep surfaces and FFTDF30xxH24 are for 29" deep surfaces.
- Width and depth are nominal sizes representing the sizes of the FreeFit Table. Allow for 1/4" overhang at the sides, 1 1/2" at the back and 6.237" at the front.
- Please choose any standard paint finish from Teknion for frame and hardware. Select also a felt finish. End trim cap is available only in CHR - charcoal.
- 9mm felt material is tackable and comes in a variety of colors.

PRODUCT CODE	PRICE	SIZE/INCHES			WEIGHT LBS	VOL FT <sup>3</sup>
		H	W	D		
FFTDF2436H24	897	24.60	34	31.50	22.55	3.94
FFTDF2442H24	921	24.60	40	31.50	24.10	4.59
FFTDF2448H24	945	24.60	46	31.50	25.65	5.25
FFTDF2454H24	968	24.60	42	31.50	27.20	5.91
FFTDF2460H24	992	24.60	58	31.50	28.75	6.56
FFTDF2466H24	1016	24.60	60	31.50	30.30	7.22
FFTDF2472H24	1040	24.60	70	31.50	31.85	7.80
FFTDF2478H24	1064	24.60	76	31.50	33.40	8.53
FFTDF2484H24	1112	24.60	82	31.50	34.95	9.19
FFTDF3036H24	928	24.60	34	37.75	36.50	4.72
FFTDF3042H24	952	24.60	40	37.75	38.05	5.51
FFTDF3048H24	976	24.60	46	37.75	39.60	6.29
FFTDF3054H24	1000	24.60	42	37.75	41.15	7.08
FFTDF3060H24	1024	24.60	58	37.75	41.70	7.87
FFTDF3066H24	1048	24.60	60	37.75	44.25	8.65
FFTDF3072H24	1072	24.60	70	37.75	45.80	9.44
FFTDF3078H24	1095	24.60	76	37.75	47.35	10.22
FFTDF3084H24	1143	24.60	82	37.75	48.90	11.01

**FFTDFxxxxH30 - Height-Adjustable Table Felt Divider Screen Kit, 30" High**

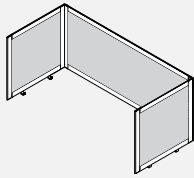

- Provides privacy in an open plan environment.
- Consists of a powder coated aluminum frame, 9mm felt and all hardware to connect. Brackets are painted steel.
- Side dividers extend 6.237" from the front edge of each surface.
- Back divider extends over the back edge of the worksurface by 1 1/2" allowing for the passage of cables to the trough.
- FFTDF24xxH30 are for 23" deep surfaces and FFTDF30xxH30 are for 29" deep surfaces.
- Width and depth are nominal sizes representing the sizes of the FreeFit Table. Allow for 1/4" overhang at the sides, 1 1/2" at the back and 6.237" at the front.
- Please choose any standard paint finish from Teknion for frame and hardware. Select also a felt finish. End trim cap is available only in CHR - charcoal.
- 9mm felt material is tackable and comes in a variety of colors.

PRODUCT CODE	PRICE	SIZE/INCHES			WEIGHT LBS	VOL FT <sup>3</sup>
		H	W	D		
FFTDF2436H30	891	30.60	34	31.50	24.85	3.94
FFTDF2442H30	913	30.60	40	31.50	26.40	4.59
FFTDF2448H30	935	30.60	46	31.50	27.95	5.25
FFTDF2454H30	957	30.60	42	31.50	29.50	5.91
FFTDF2460H30	979	30.60	58	31.50	31.05	6.56
FFTDF2466H30	1002	30.60	60	31.50	32.60	7.22
FFTDF2472H30	1024	30.60	70	31.50	34.15	7.88
FFTDF2478H30	1046	30.60	76	31.50	35.70	8.53
FFTDF2484H30	1099	30.60	82	31.50	37.25	9.19
FFTDF3036H30	933	30.60	34	37.75	38.80	4.72
FFTDF3042H30	956	30.60	40	37.75	40.35	5.51
FFTDF3048H30	978	30.60	46	37.75	41.90	6.29
FFTDF3054H30	1000	30.60	42	37.75	43.45	7.08
FFTDF3060H30	1024	30.60	58	37.75	45.00	7.87
FFTDF3066H30	1046	30.60	60	37.75	46.55	8.65
FFTDF3072H30	1068	30.60	70	37.75	48.10	9.44
FFTDF3078H30	1090	30.60	76	37.75	49.65	10.22
FFTDF3084H30	1142	30.60	82	37.75	51.20	11.01

**FTATB • Boulevard Connector Kit**

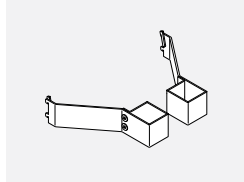

- FreeFit to Boulevard kit secures FreeFit height-adjustable freestanding tables to parallel Boulevard panels.
- It provides panel/table alignment, preventing moving parts from rubbing against panel vertical surfaces and maintains 1" clearance around table surface perimeter.
- Standard metal finishes.
- All hardware included.
- Sold as a pair.
- Note: - Kit connects to C style base only.

PRODUCT CODE	PRICE	SIZE/INCHES			WEIGHT VOL	
		H	W	D	LBS	FT <sup>3</sup>
FTATB	194	10	6.5	10	7.00	0.50

**FTAEG • Back-to-Back End Gable**

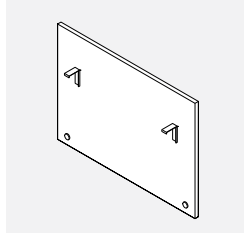

- Optional Back-to-Back FreeFit End Gable is intended to be installed at the end of FreeFit Back-to-Back table run.
- Made out of 3/4" PL Laminated, it enhances FreeFit table assembly aesthetics by reducing number of visible elements below work surface.
- Two heights available.
- The End Gable connects to FreeFit H-frame crossbar; compatible with Floor Feed.
- Please specify LP finish.
- Please specify paint finish for the brackets.

PRODUCT CODE	PRICE	SIZE/INCHES			WEIGHT VOL	
		H	D	W	LBS	FT <sup>3</sup>
FTAEG18H	433	18	30	0.75	10.00	0.24
FTAEG22H	468	23	30	0.75	13.00	0.30

**FTACPU • CPU Holder**

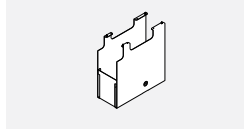

- Accepts tower CPU's with a width range from 7.6" to 2.25"- and a maximum height of 18"
- Durable sheet metal construction
- Please specify paint finish.

PRODUCT CODE	PRICE	SIZE/INCHES			WEIGHT VOL	
		H	D	W	LBS	FT <sup>3</sup>
FTACPU	403	21	21	8	3.57	2.04

**BRTLCS • Locking Caster for Rectangular Leg Tables**

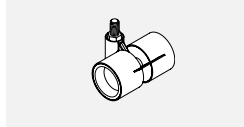

- Locking Caster for Rectangular Table.
- 40mm dia. locking caster with 8mm thread; whitebody, light grey tires.

PRODUCT CODE	PRICE	SIZE/INCHES			WEIGHT VOL	
		H	D	W	LBS	FT <sup>3</sup>
BRTLCS	33	2.5	2.7	2.6	0.06	0.01

**FTFOOTxxTL • T-foot**

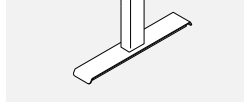

- Replacement single "T" foot.
- Includes attachment hardware.

PRODUCT CODE	PRICE	SIZE/INCHES			WEIGHT VOL	
		H	D	W	LBS	FT <sup>3</sup>
FTFOOT24TL	136	1.16	23	3	4.4	0.25
FTFOOT30TL	144	1.16	29	3	4.85	0.31

**FTFOOTxxCL - C-foot**

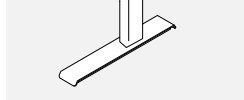

- Replacement single "C" foot.
- Includes attachment hardware.

PRODUCT CODE	PRICE	SIZE/INCHES			WEIGHT VOL	
		H	D	W	LBS	FT <sup>3</sup>
FTFOOT24CL	160	1.16	23	3	4.4	0.25
FTFOOT30CL	167	1.16	29	3	4.85	0.31

**FTSETGLIDE • Set of Glides**

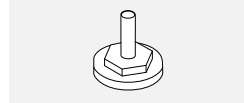

- Replacement Glides a set of two with 1/2" adjustment

PRODUCT CODE	PRICE	SIZE/INCHES			WEIGHT VOL	
		H	D	W	LBS	FT <sup>3</sup>
FTSETGLIDE	15	1	1.5	1.5	0.06	0.01

**BRLBST • Single Table Accessory Rail**

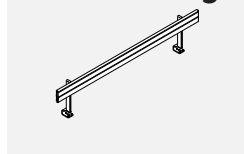

- Table mounted accessory rail.
- Compatible with standard Bins, Trays and Sorters.
- Includes end caps and mounting hardware.
- Please specify paint finish
- To ensure proper connection and clearance on tables 46" wide and up, choose accessory rail 13" smaller than the actual table width (70" wide table gets 57" wide rail).
- Tables 40" wide and smaller use 33" wide accessory rail.

PRODUCT CODE	PRICE	SIZE/INCHES			WEIGHT VOL	
		H	W	D	LBS	FT <sup>3</sup>
BRLBST36	366	16	33	2.95	5.9	0.26
BRLBST42	384	16	39	2.95	6.44	0.30
BRLBST48	398	16	45	2.95	6.98	0.35
BRLBST54	412	16	51	2.95	7.52	0.39
BRLBST60	423	16	57	2.95	8.07	0.43
BRLBST66	437	16	63	2.95	8.61	0.48
BRLBST72	452	16	69	2.95	9.15	0.52
BRLBST78	465	16	75	2.95	9.69	0.56
BRLBST84	480	16	81	2.95	10.24	0.61

**GCBMSG • Board-Mounted Wellness Screen**

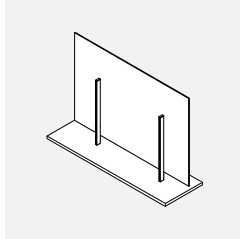

- Surface mounted wellness screen provides a physical divider.
- Choose LP (low pressure laminate color).
- Acrylic glazing is clear and support rails are painted DWT Designer White.
- Kit includes all hardware to assemble and place on top of a surface.
- Actual height of the acrylic is 31.5", screws will allow acrylic to be installed at any height along the vertical rails to allow a 1/2" to 10" gap.

PRODUCT CODE	PRICE	SIZE/INCHES			WEIGHT VOL	
		H	W	D	LBS	FT <sup>3</sup>
GCBMSG3636LP	611	36	36	12	28.45	2.92
GCBMSG3648LP	787	36	48	12	34.17	3.98

**GCAMSG • Wellness Screen Only, for Use With Existing Worksurface or Transaction Top**

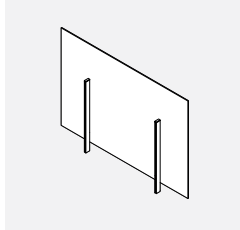

- Surface mounted wellness screen provides a physical divider.
- Acrylic glazing is clear and support rails are painted DWT Designer White.
- Kit includes all hardware to install on an existing surface.
- Actual height of the acrylic is 31.5", screws will allow acrylic to be installed at any height along the vertical rails to allow a 1/2" to 10" gap.

PRODUCT CODE	PRICE	SIZE/INCHES			WEIGHT VOL	
		H	W	D	LBS	FT <sup>3</sup>
GCAMSG3636LP	458	36	36	2	20.2	2.92
GCAMSG3648LP	527	36	48	2	22.8	3.98

**GCBRMSG • Wellness Screen With Surface Mounting Bracket, For Use With Existing Worksurface or Transaction Topface or Transaction Top**

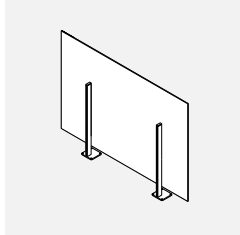

- Surface mounted wellness screen provides a physical divider.
- Acrylic glazing is clear and support rails are painted DWT Designer White.
- Kit includes all hardware to install on an existing surface.
- Actual height of the acrylic is 31.5", screws will allow acrylic to be installed at any height along the vertical rails to allow 1/2" to 10" gap.

PRODUCT CODE	PRICE	SIZE/INCHES			WEIGHT VOL	
		H	W	D	LBS	FT <sup>3</sup>
GCBRMSG3636LP	550	36	36	5	20.2	2.92
GCBRMSG3648LP	687	36	48	5	22.8	3.98

**GCTCSG • Wellness Screen With Clamp Mount Bracket, for Use With Existing Worksurface or Transaction Top**

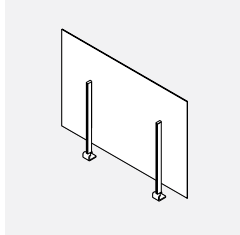

- Surface mounted wellness screen provides a physical divider.
- Acrylic glazing is clear and support rails are painted DWT Designer White.
- Kit includes all hardware to install on an existing surface.
- Actual height of the acrylic is 31.5", screws will allow acrylic to be installed at any height along the vertical rails to allow 1/2" to 10" gap.
- LP code indicated dividers will fit on 1" thick surfaces, where the W code will fit on 1 1/2" thick surfaces.

PRODUCT CODE	PRICE	SIZE/INCHES			WEIGHT VOL	
		H	W	D	LBS	FT <sup>3</sup>
GCTCSG3636LP	551	36	36	3	20.2	2.92
GCTCSG3648LP	687	36	48	3	22.8	3.98
GCTCSG3636W	566	36	36	3	20.2	2.92
GCTCSG3648W	702	36	48	3	22.8	3.98

**L2RSB • Screening Booth**

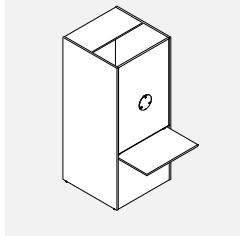

- Screening Booth is ideal for hospitals, clinics, reception areas or anywhere a safe self-contained environment is required.
- Screening Booth has a protected speaker hold, a paper space above the work surface, a interior and exterior work surface.
- The gap between the work surface and glazed frame can be changed during assembly from 1.5" to 4" based on the direction of the screen.
- Booth available in DWTL - Designer White only.
- Can be closed or connected with Diet Laminate Panels.
- Ships knocked down.

PRODUCT CODE	PRICE	SIZE/INCHES			WEIGHT LBS	VOL FT <sup>3</sup>
		H	W	D		
L2RSB	3266	82	36	36	238.81	61.50

**L2SBCF • Screening Booth Ceiling Feed Pole**

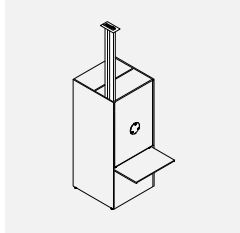

- Screening Booth Ceiling Pole can be used to bring power and/or data from the ceiling to the Booth.
- Aluminum extrusion comes in powder coated paint finish, DWT - Designer White or TUN - Tungsten.
- Kit includes aluminum extrusions, spacer, trim kit and double-sided adhesive tape.
- Maximum ceiling height of 108".

PRODUCT CODE	PRICE	SIZE/INCHES			WEIGHT LBS	VOL FT <sup>3</sup>
		H	W	D		
L2SBCF	184	76.5	4.5	1.5	8.69	0.29